



BIBLIOTECA CENTRALA  
A  
UNIVERSITAȚII  
DIN  
BUCUREȘTI

No. Curent 18652 Format.....

No. Inventar 24557 Anul.....

Secția..... Raftul.....



~~In. A. 66.642~~

IV. 18652

COURS

DE

MATHÉMATIQUES

A L'USAGE

DES ARCHITECTES, INGÉNIEURS CIVILS, ETC.

PAR J. ADHÉMAR

328180

[Tom. 6]

PONTS BIAIS EN PIERRE ET EN BOIS



Troisième Édition

PARIS

ARMAND COLIN & C<sup>o</sup>, ÉDITEURS

16, RUE DE CONDÉ, 16

1876



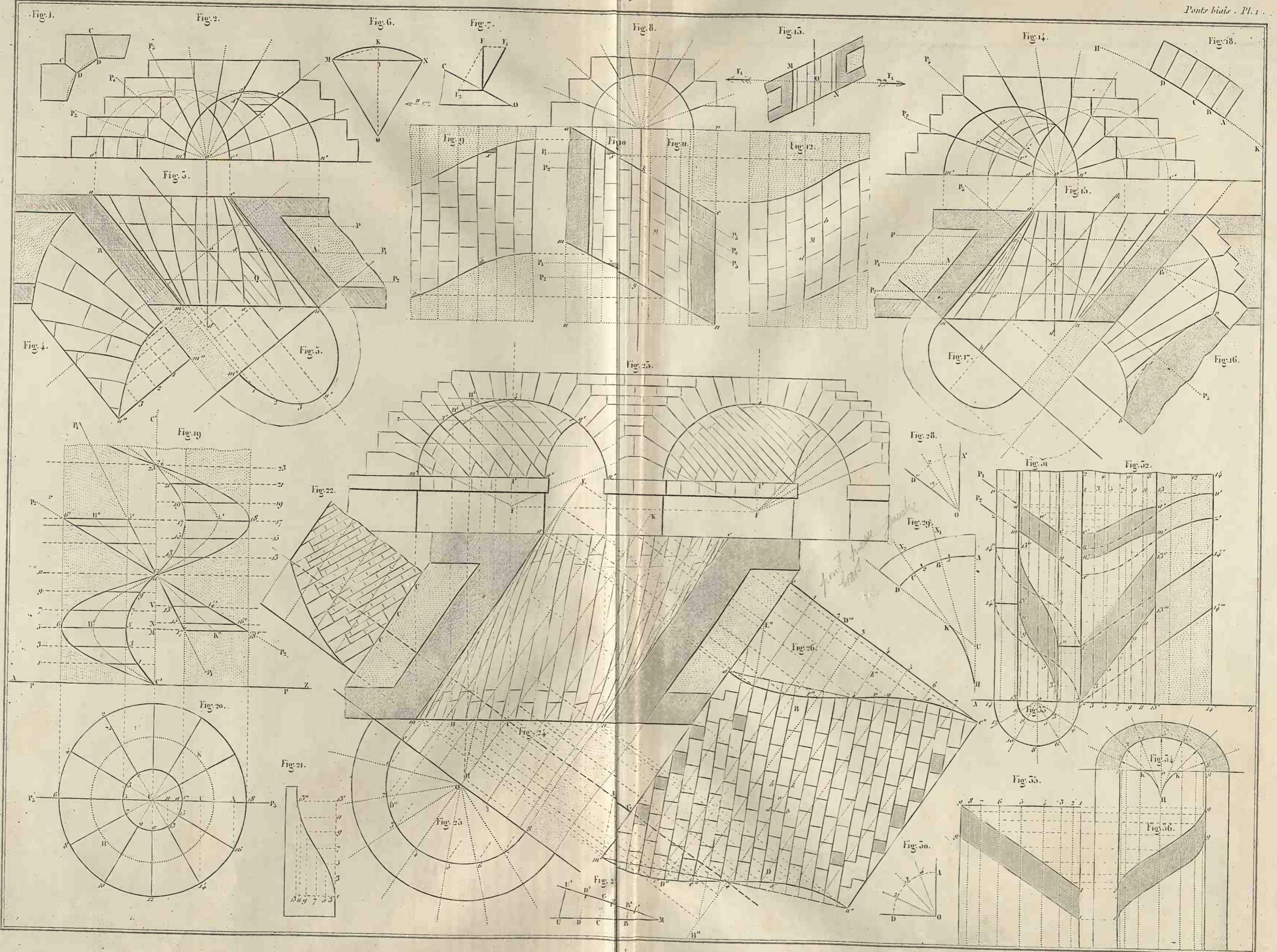



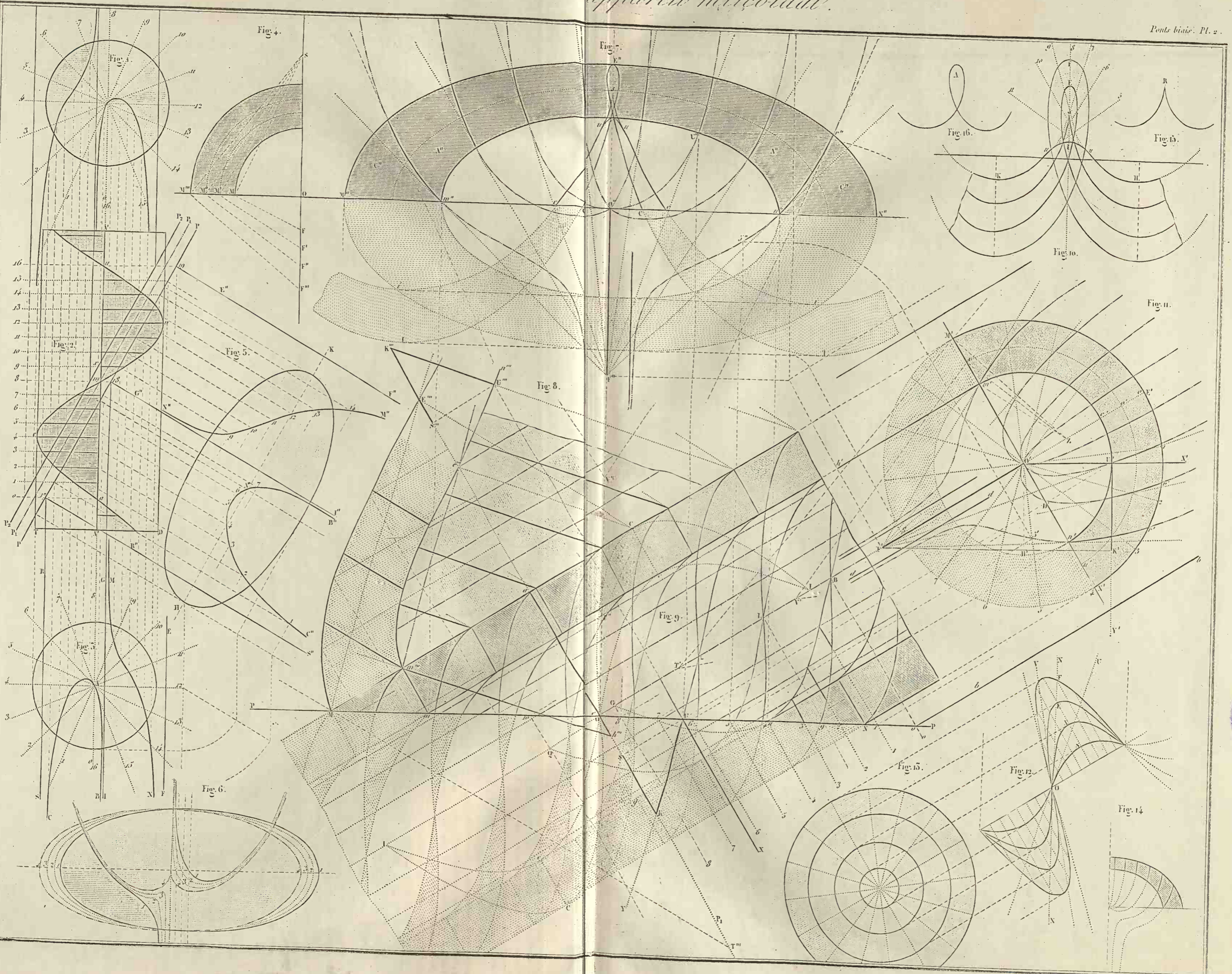



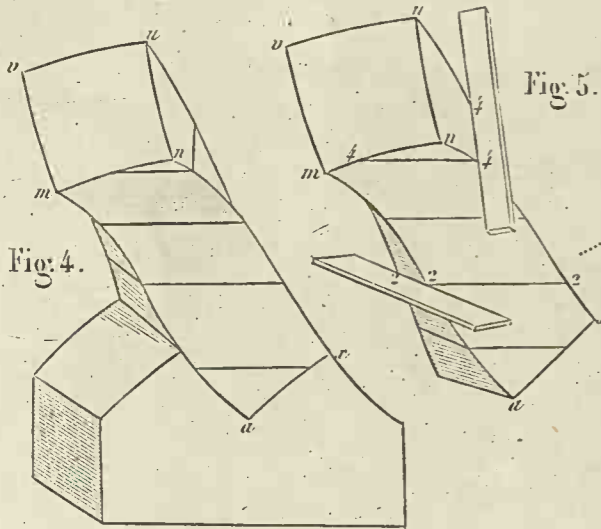
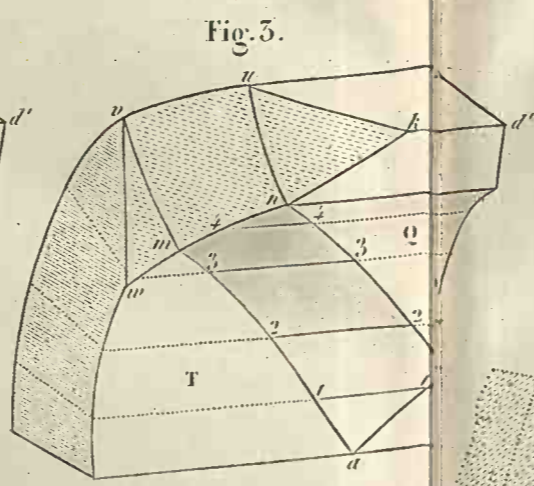
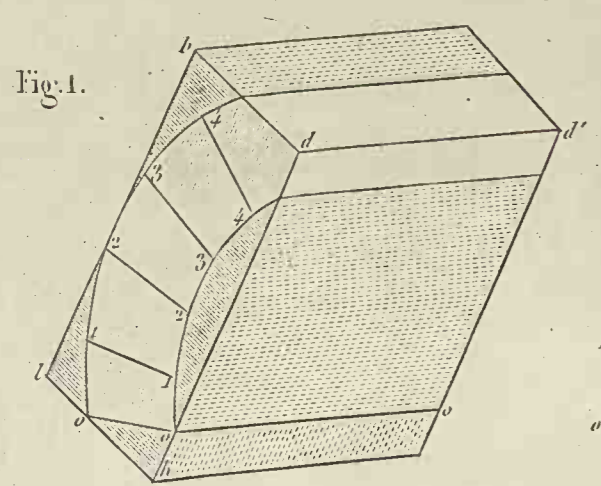

Fig. 5.

Fig. 6.

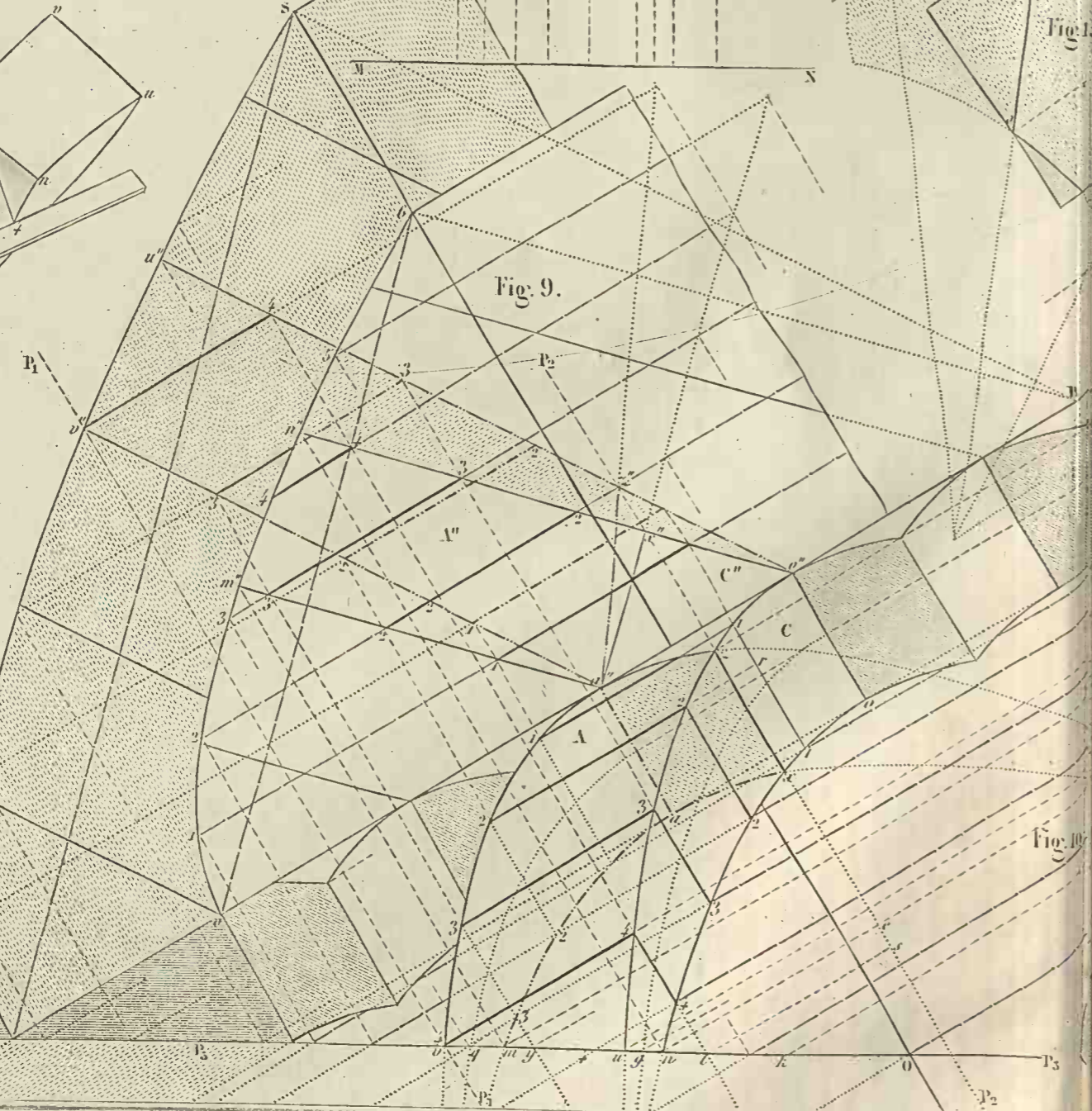
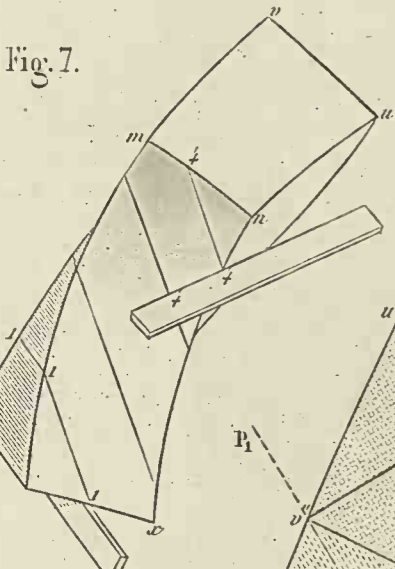

Fig. 9.

Fig. 10.

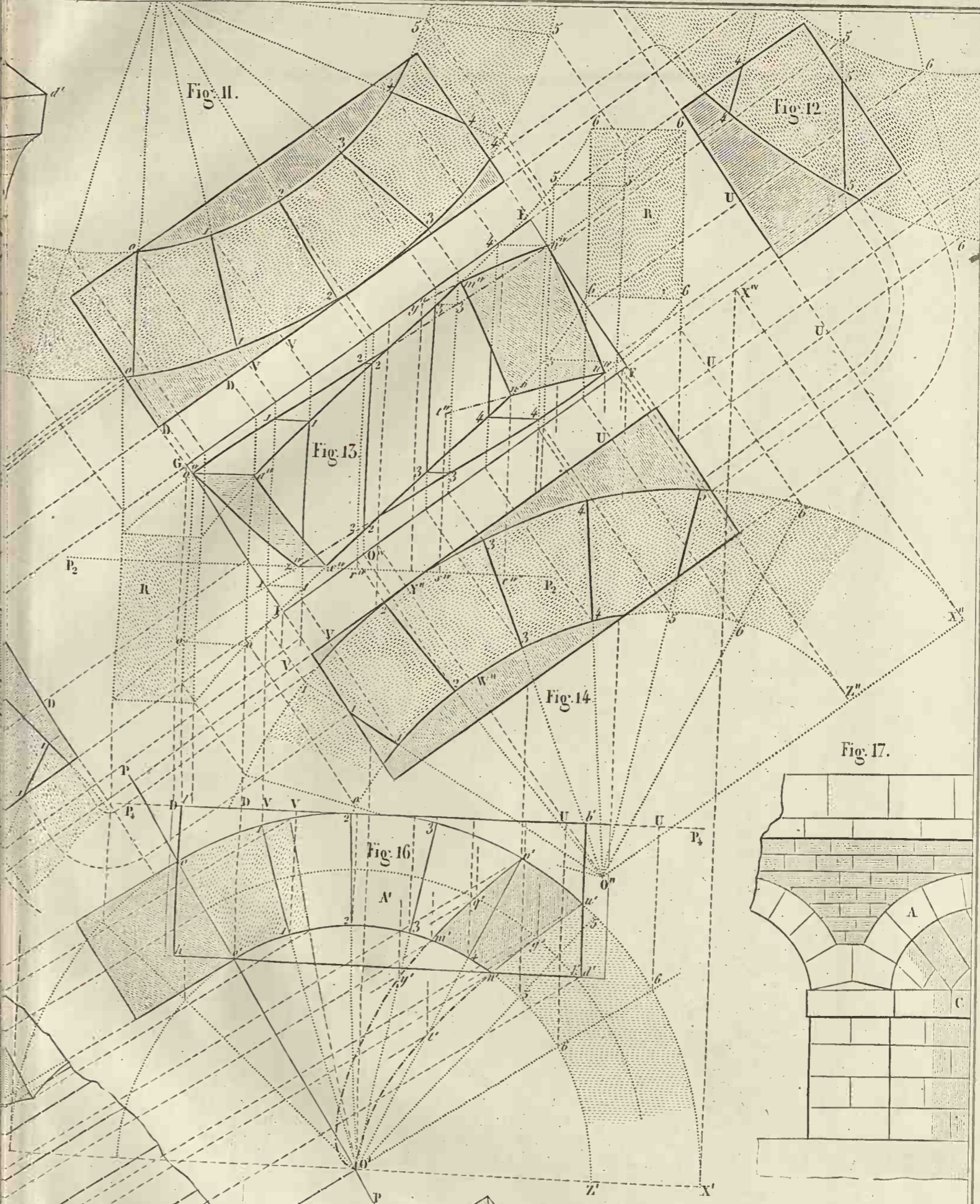

Fig. 11.

Fig. 12.

Fig. 13.

Fig. 14.

Fig. 16.

Fig. 17.

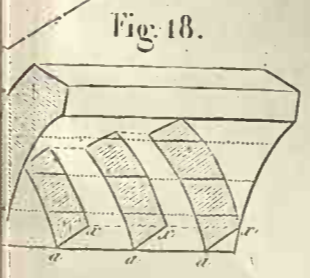

Fig. 18.

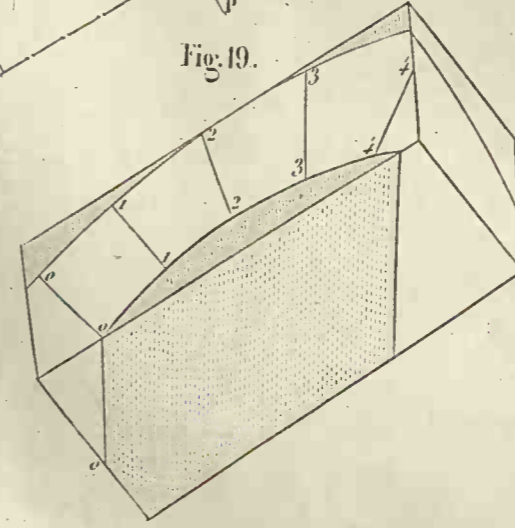

Fig. 19.

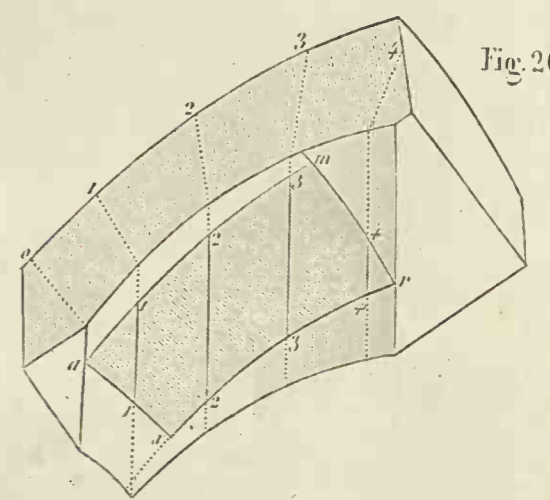
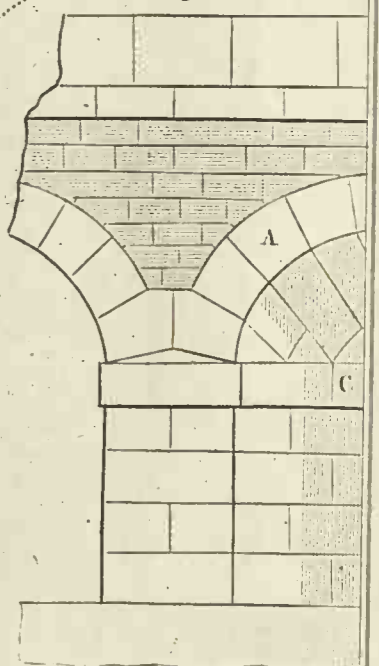

Fig. 20.





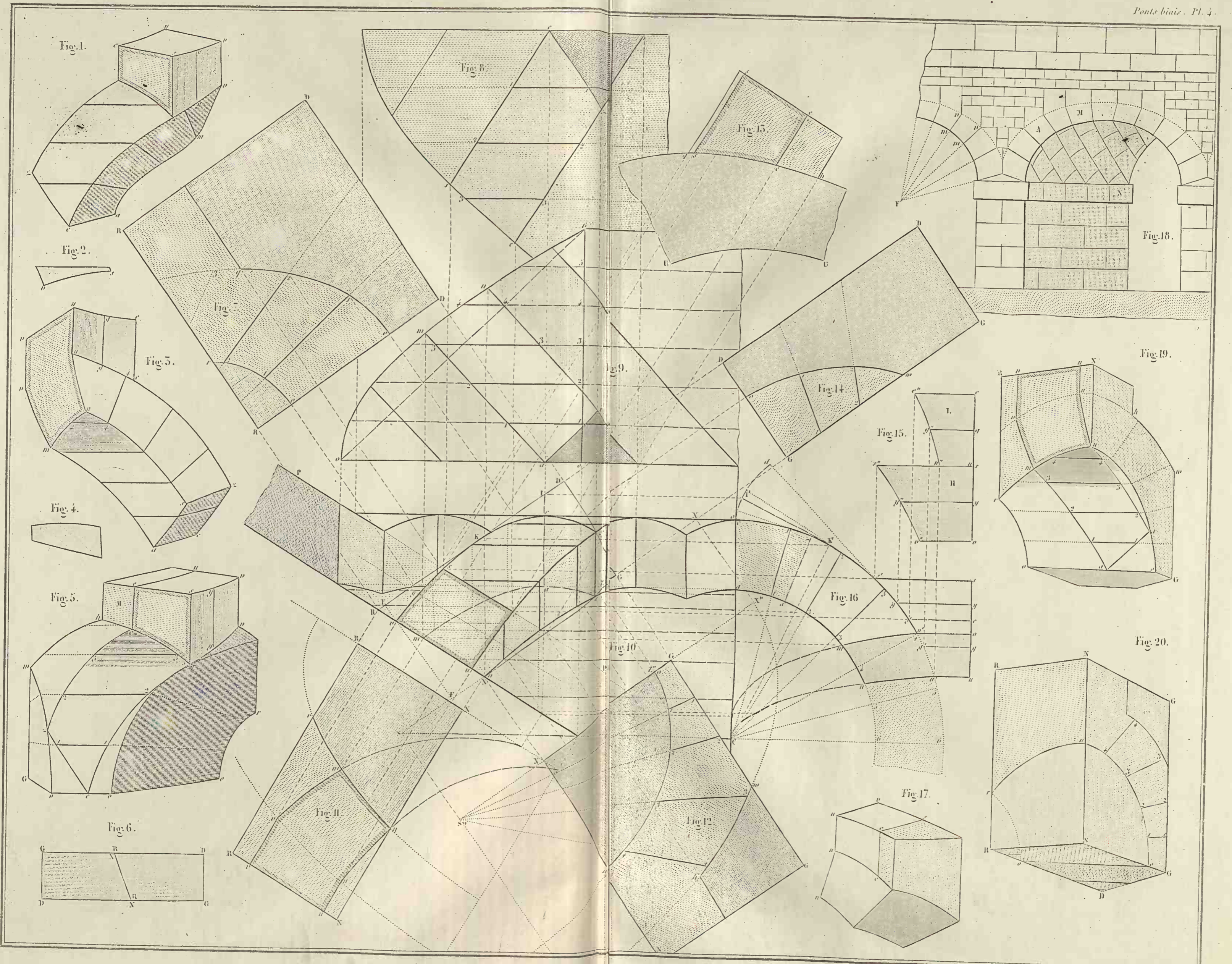

Fig. 1.

Fig. 2.

Fig. 3.

Fig. 4.

Fig. 5.

Fig. 6.

Fig. 8.

Fig. 15.

Fig. 18.

Fig. 19.

Fig. 15.

Fig. 16.

Fig. 10.

Fig. 11.

Fig. 12.

Fig. 17.

Fig. 20.



Fig. 1.

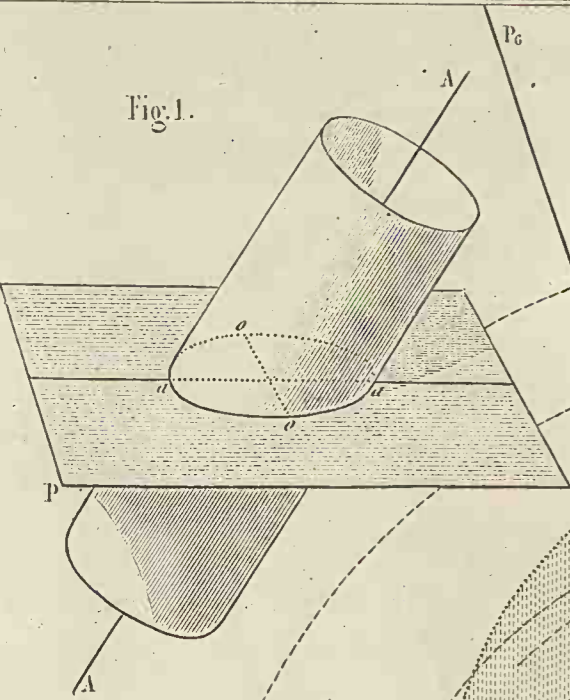

Fig. 2.

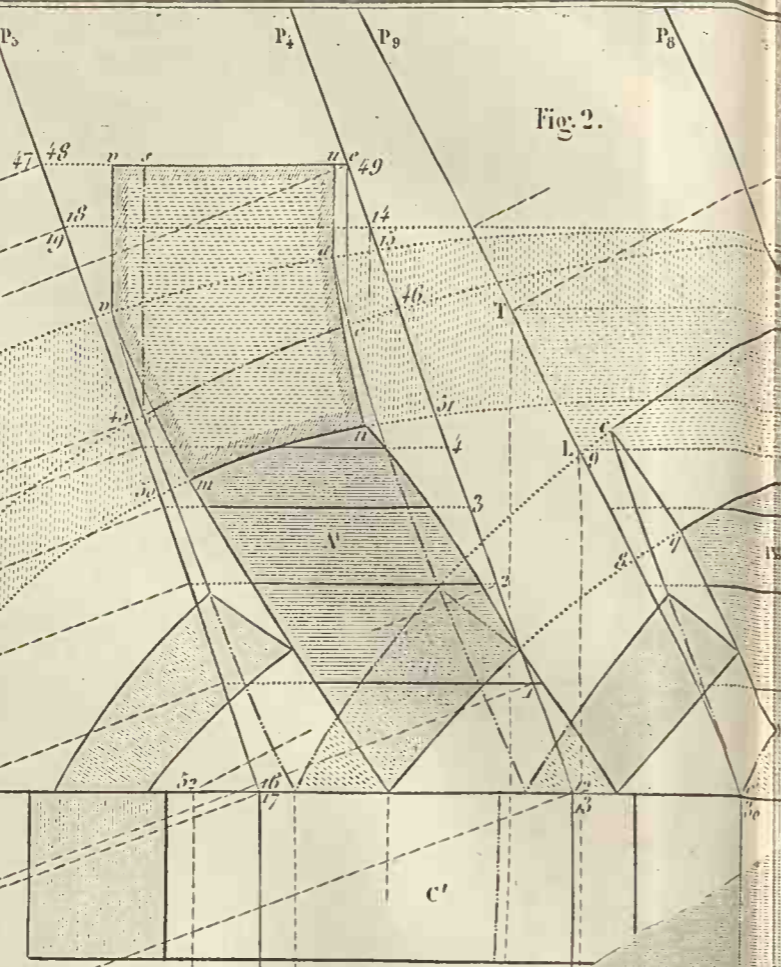

Fig. 5.

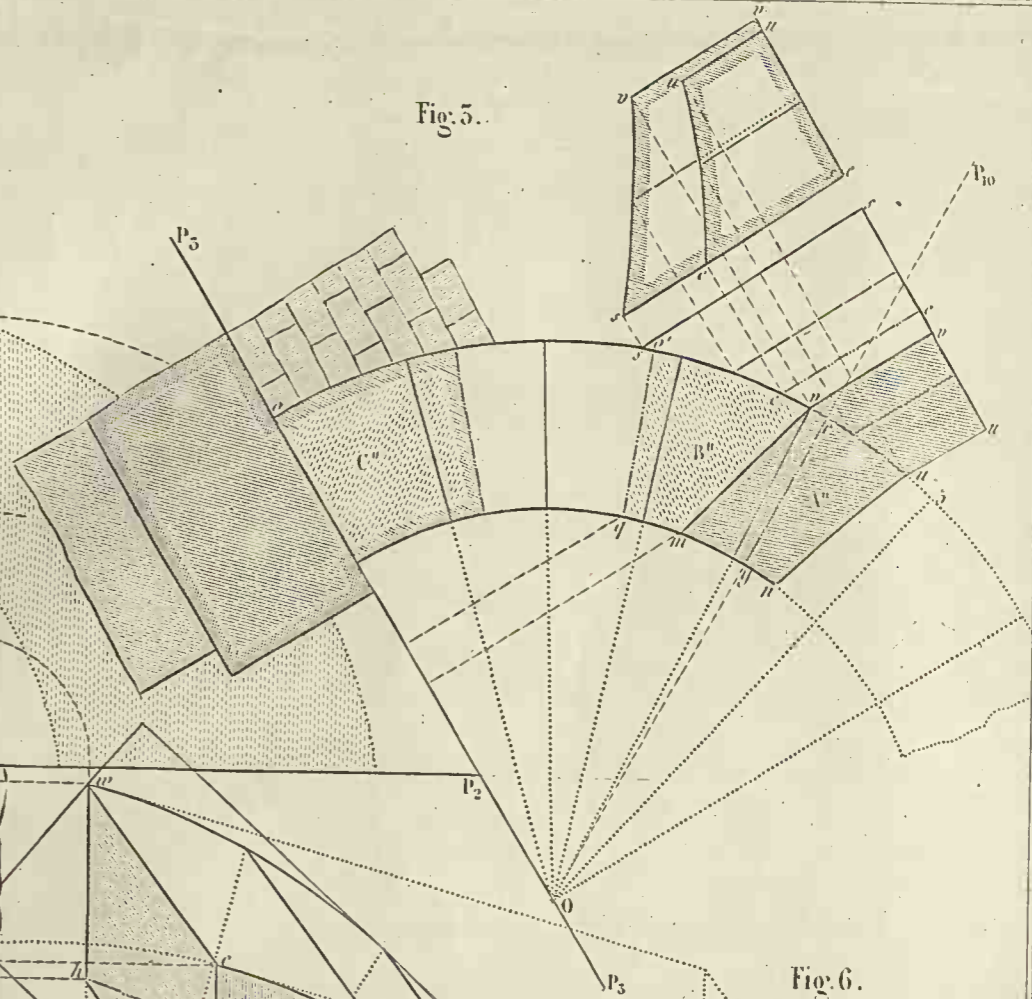

Fig. 4.

Fig. 5.

Fig. 6.

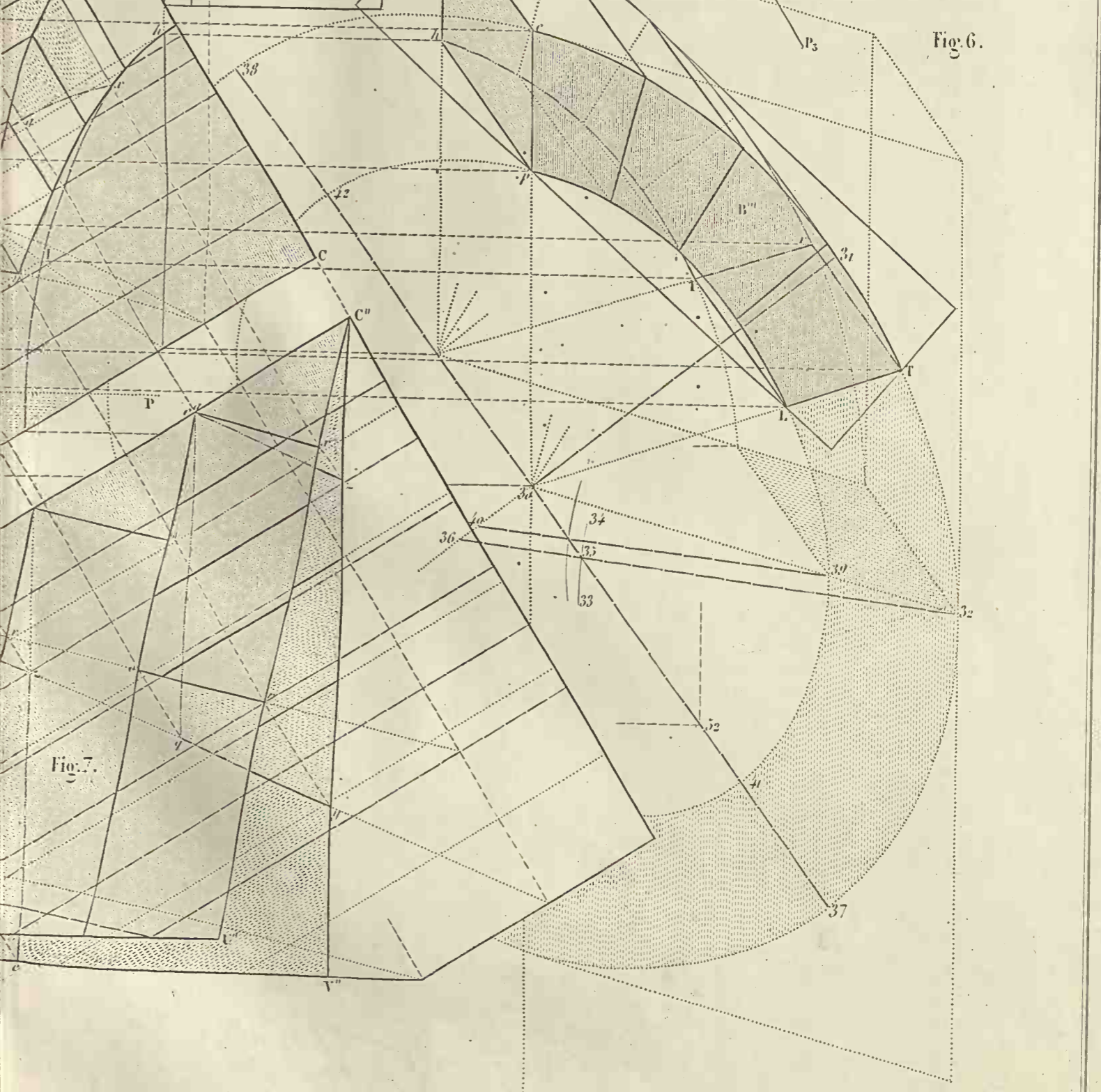
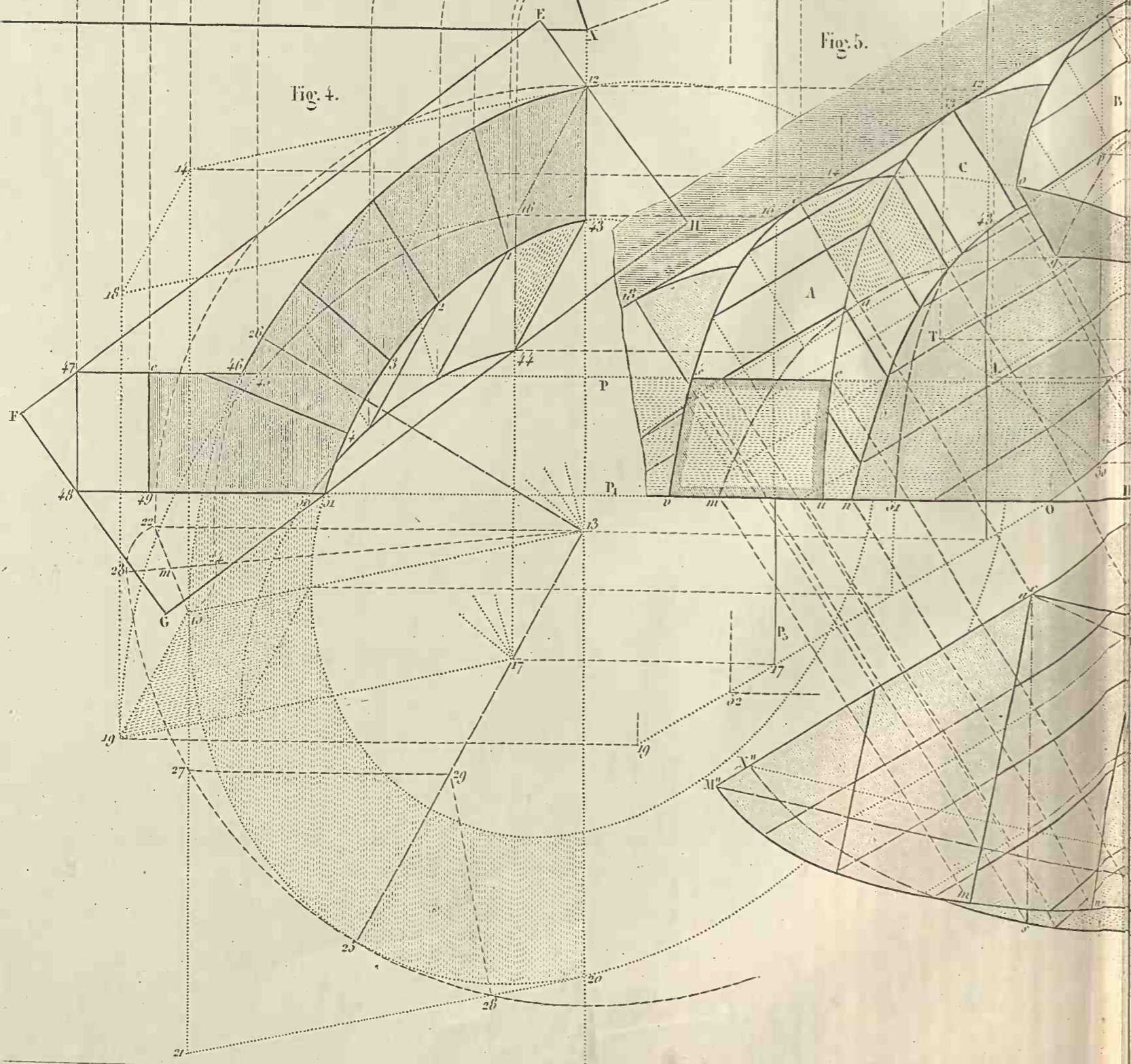

Fig. 7.

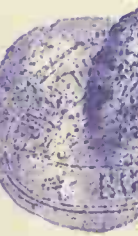



Fig. 1.

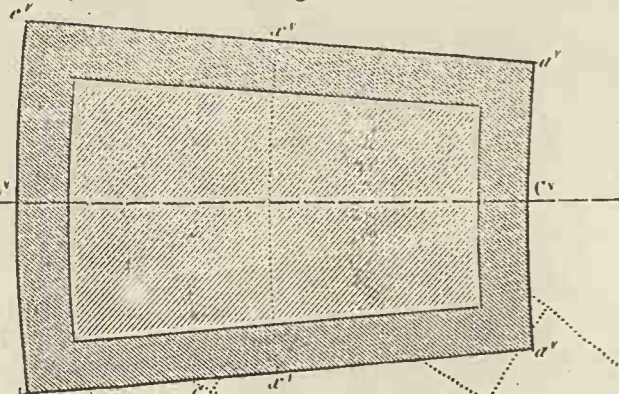

Fig. 7.

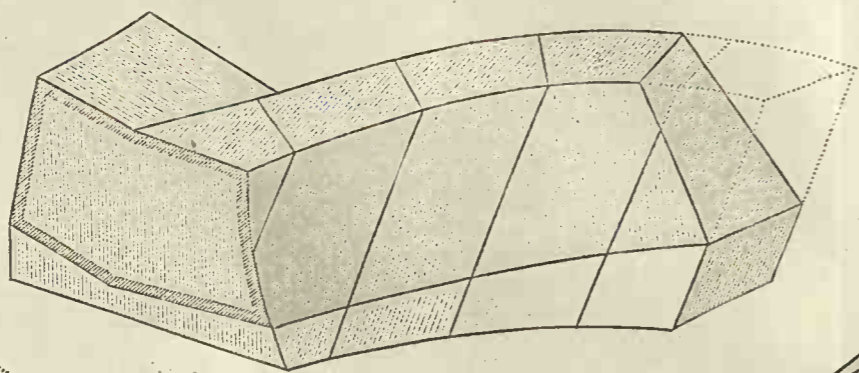

Fig. 5.

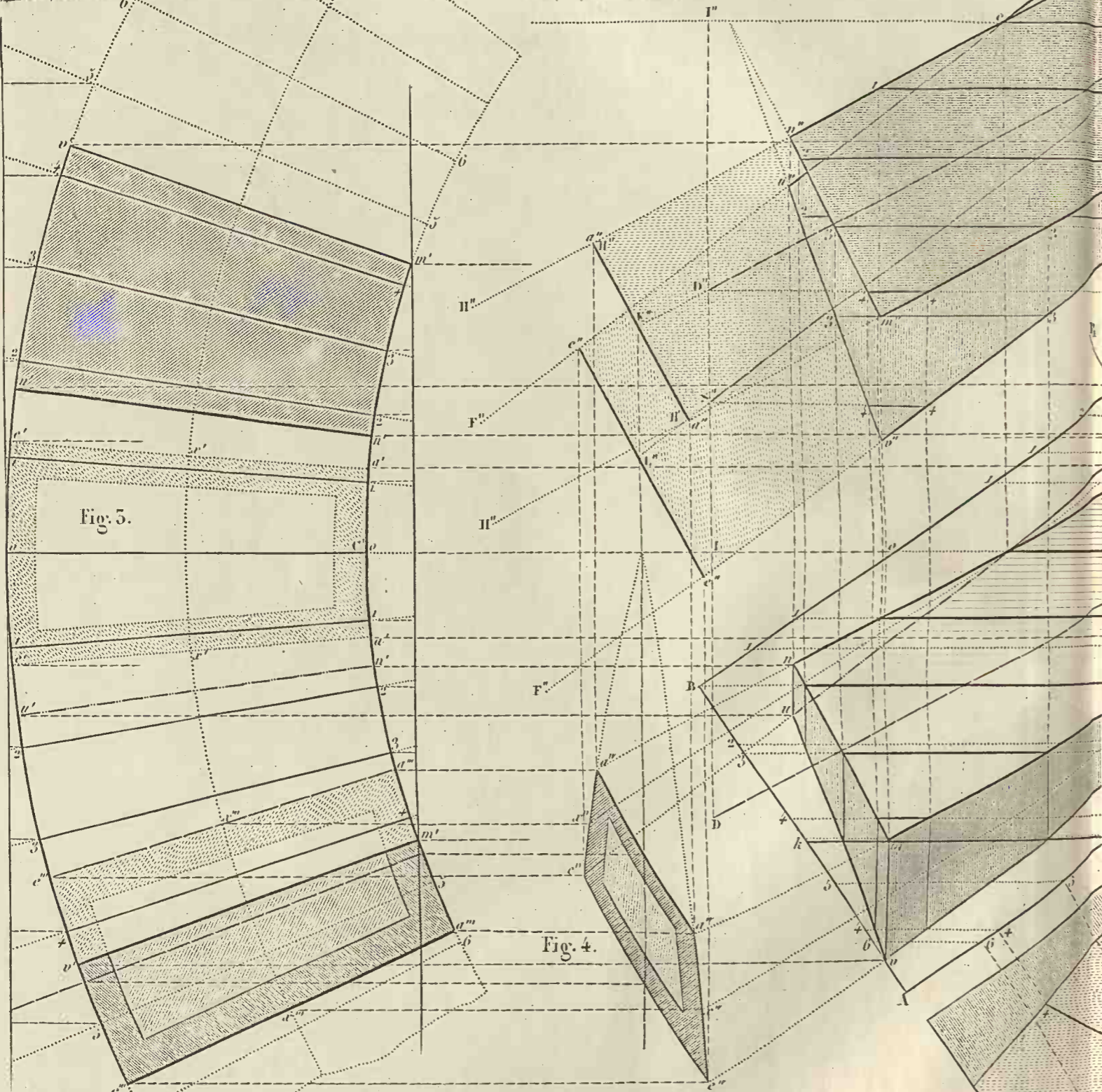

Fig. 5.

Fig. 4.

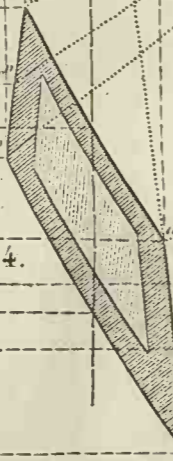

Fig. 2.



Fig. 11.

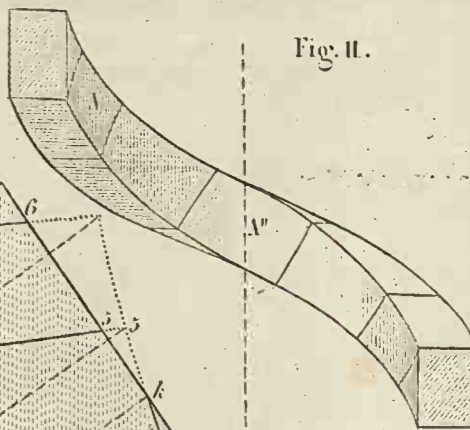

Fig. 10.

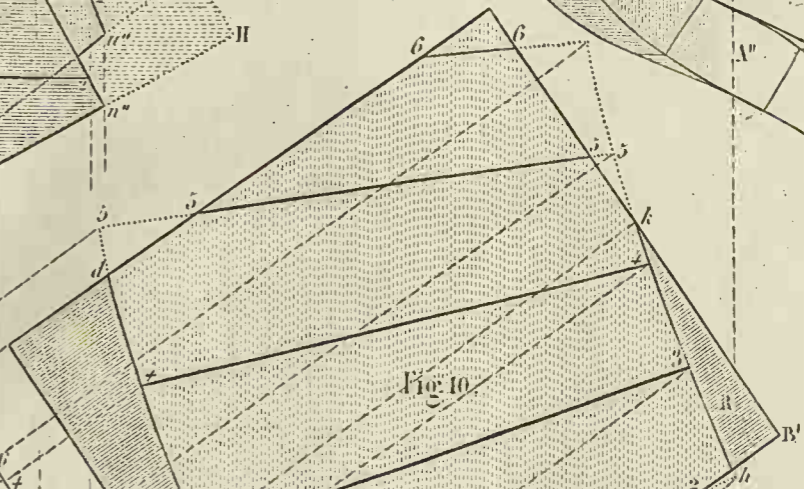

Fig. 6.

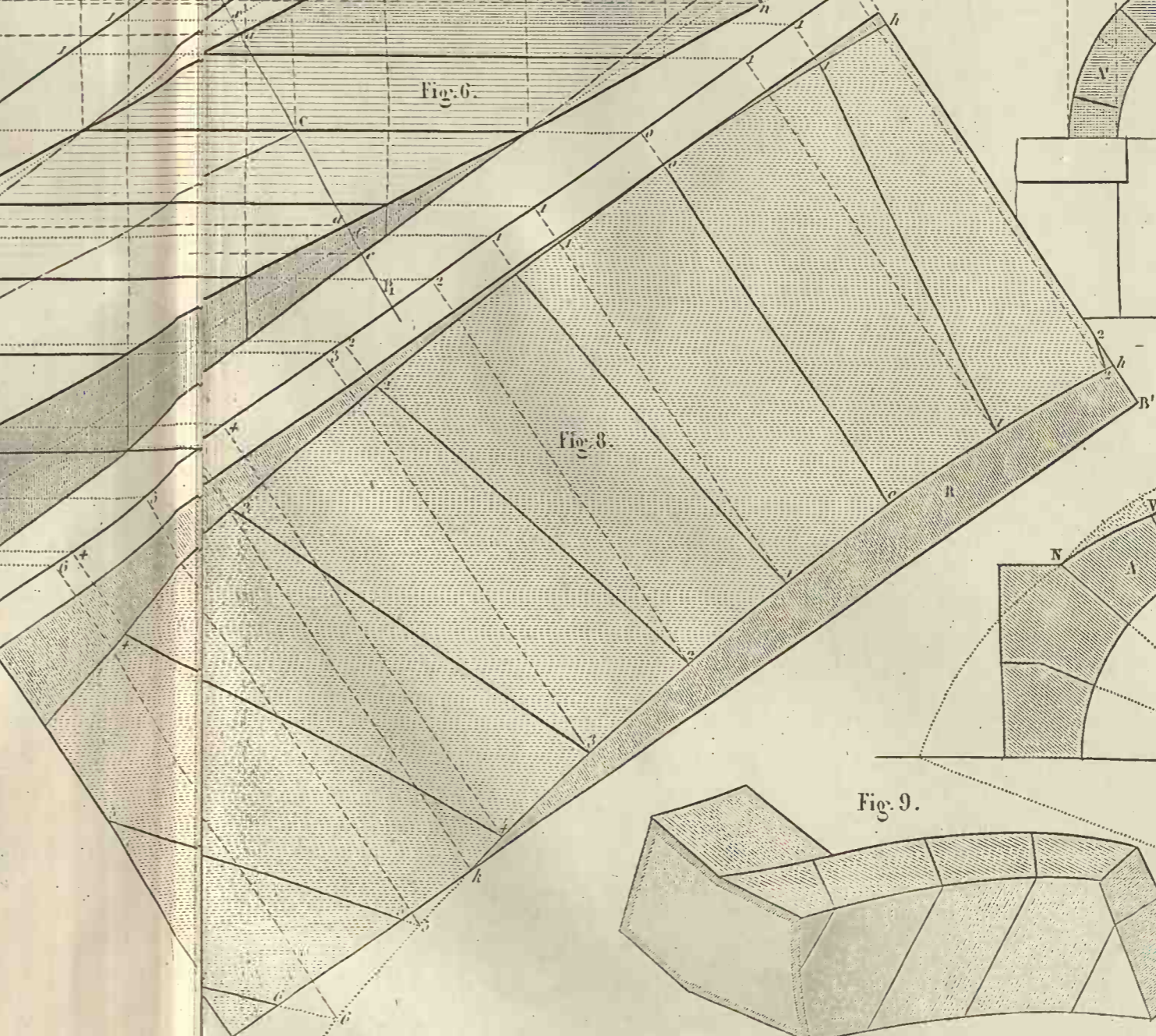

Fig. 8.

Fig. 12.

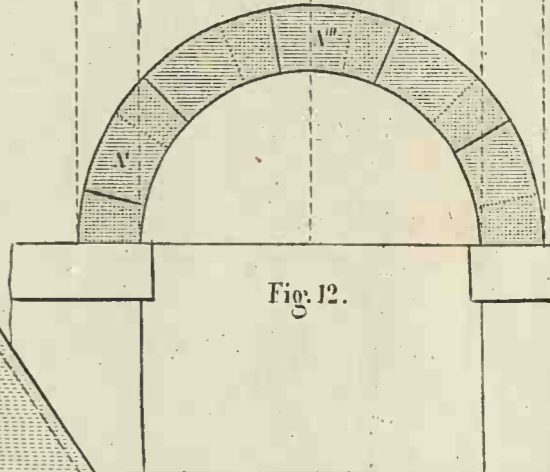

Fig. 15.

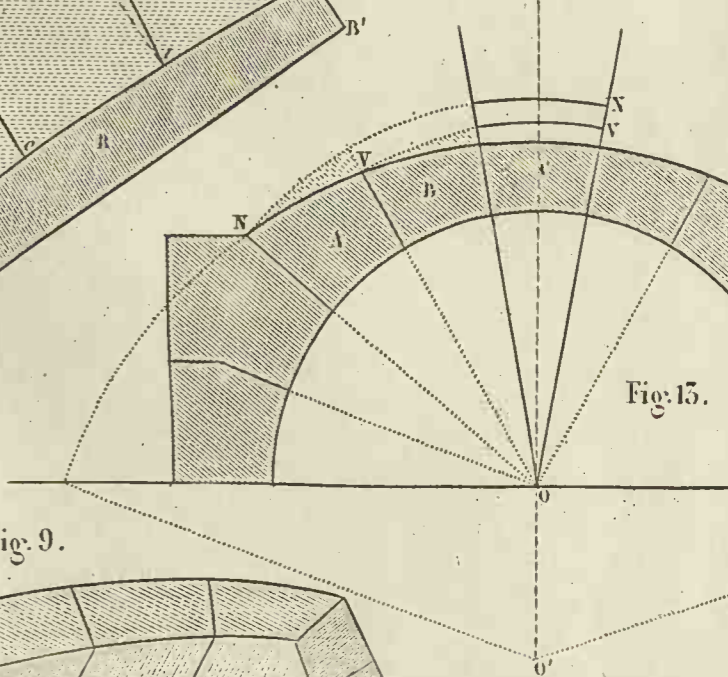
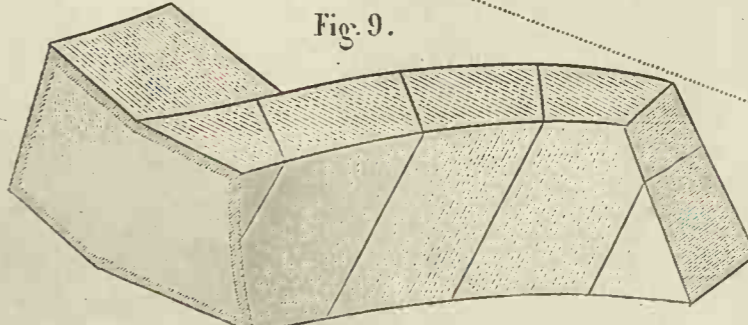
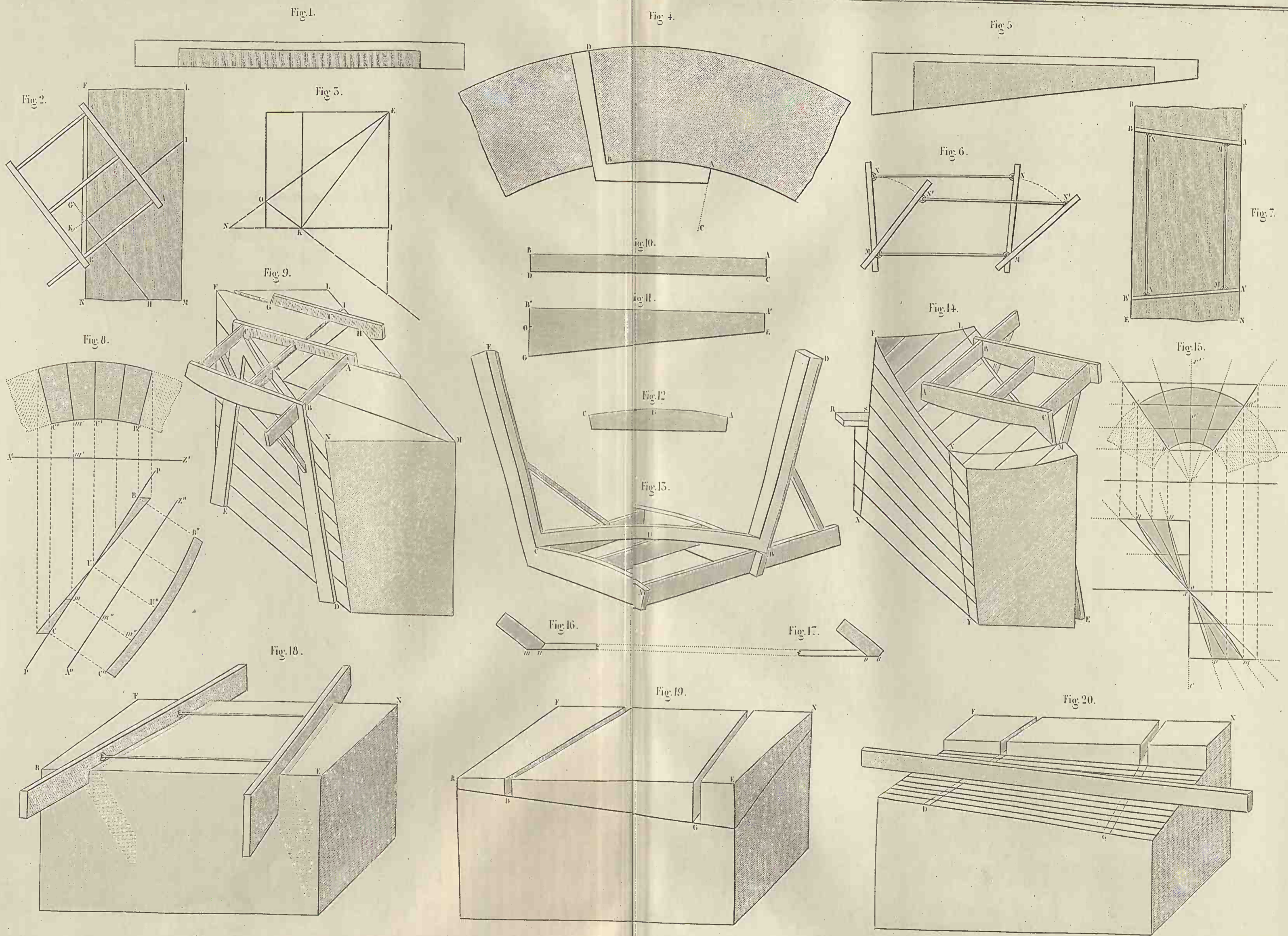

Fig. 9.









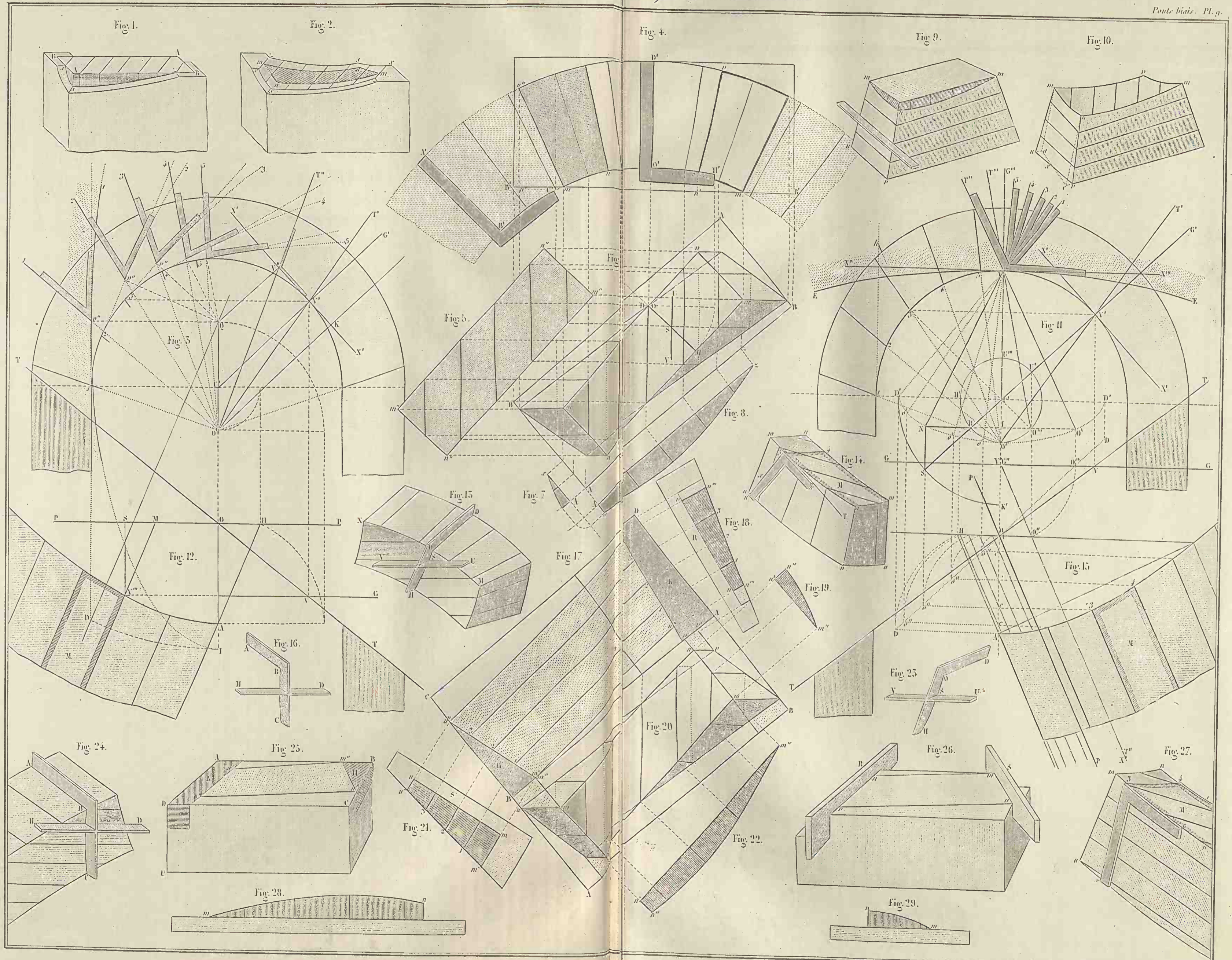



Ponts biais - Berceau circulaire - Joints normaux

Coupe des pierres. Pl. 77.

Ponts biais. Pl. 10.

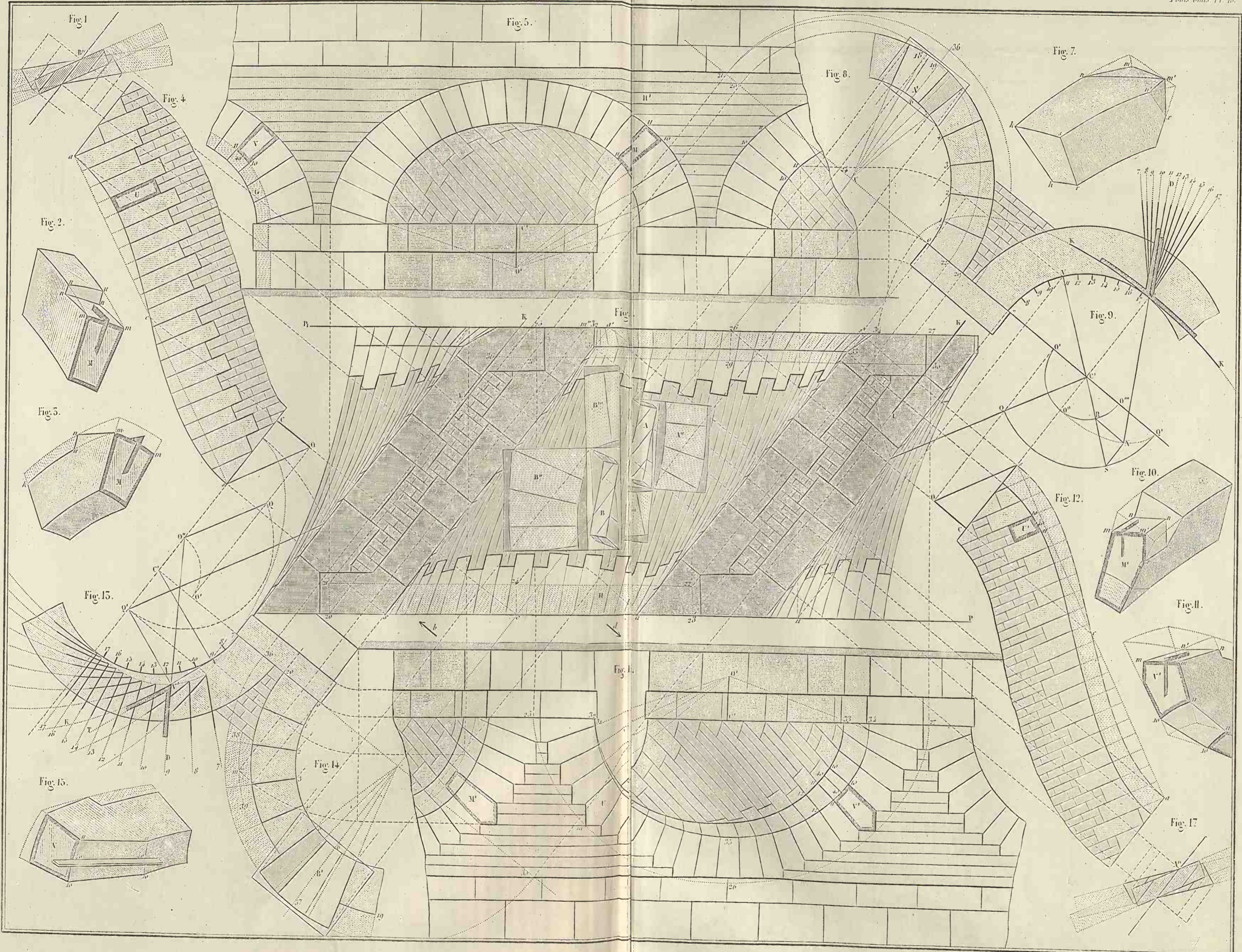

Adrien Del.



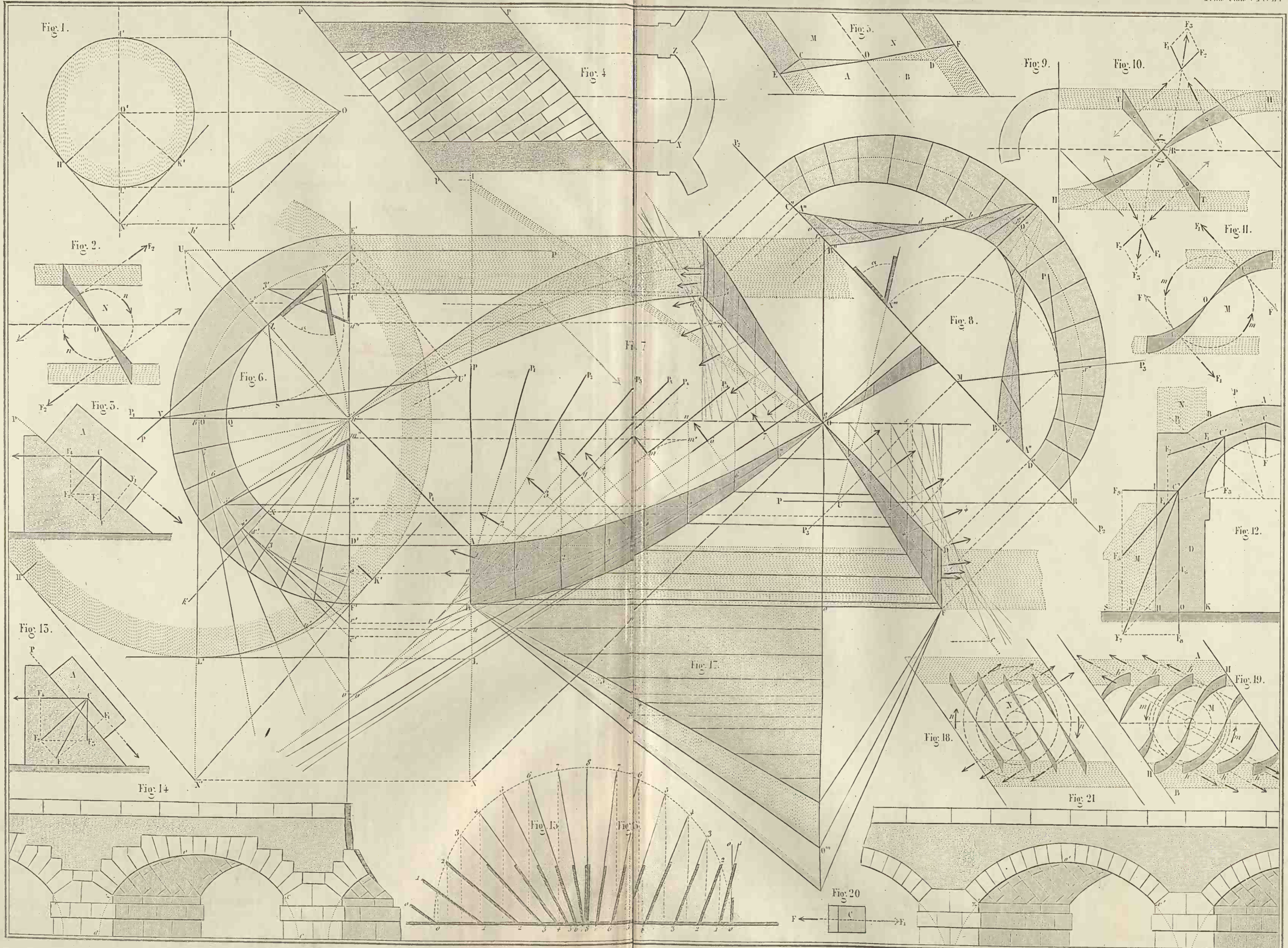



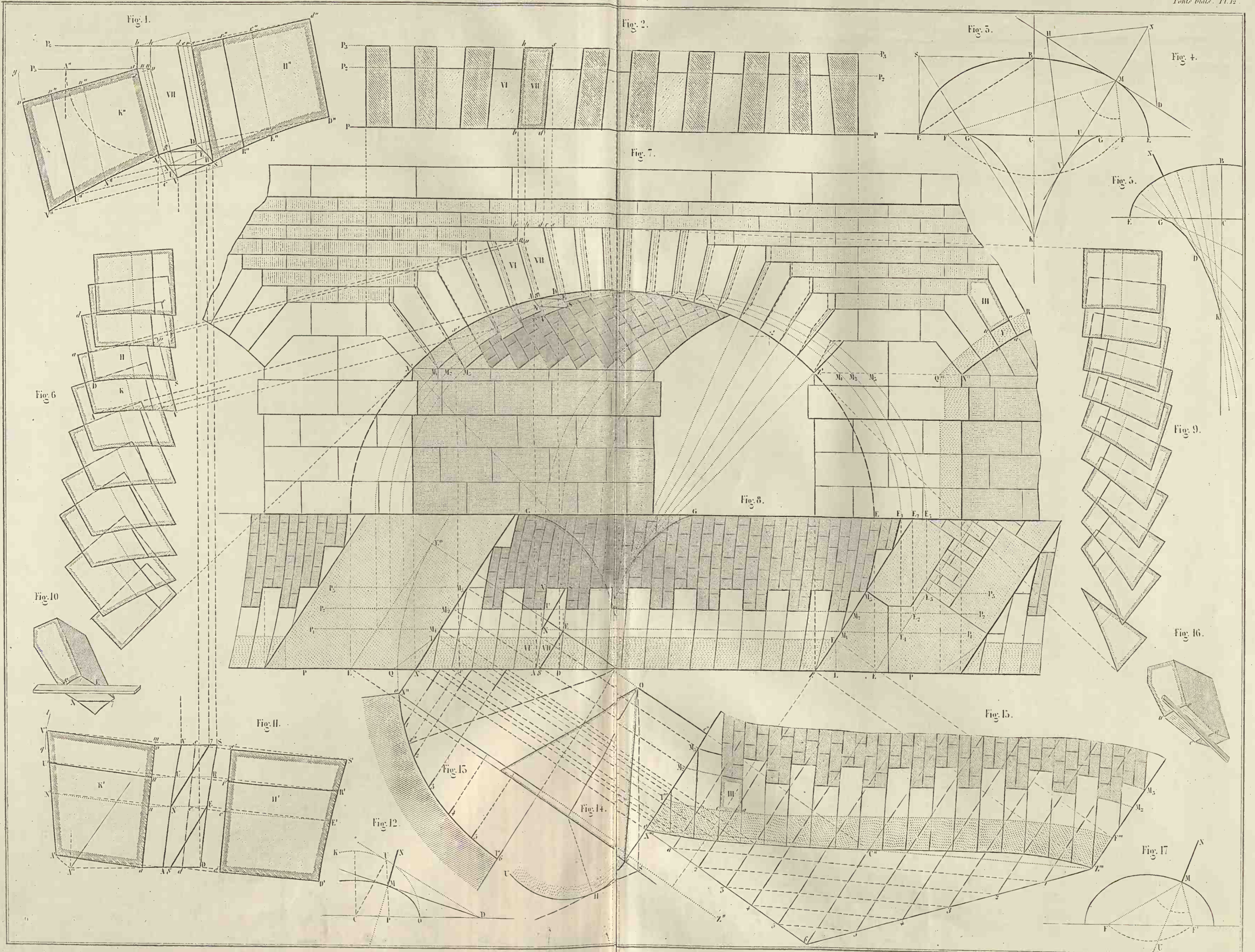



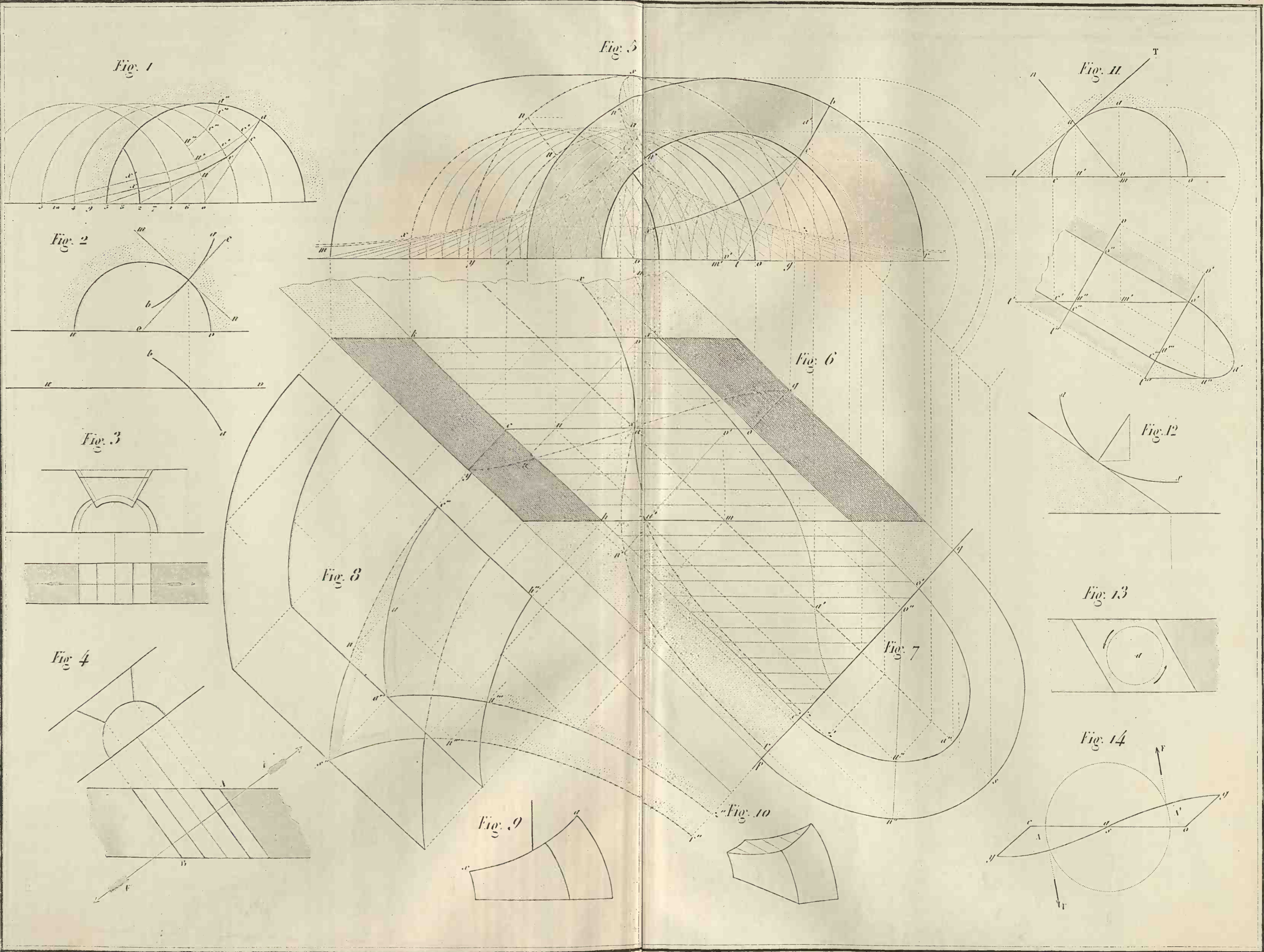



Ponts biais - appareil orthogonal - Joints Plans

Coupe des pierres. Pl. 82.

Ponts biais. Pl. 15.

Fig. 1

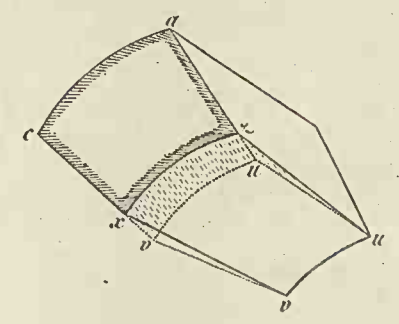

Fig. 2

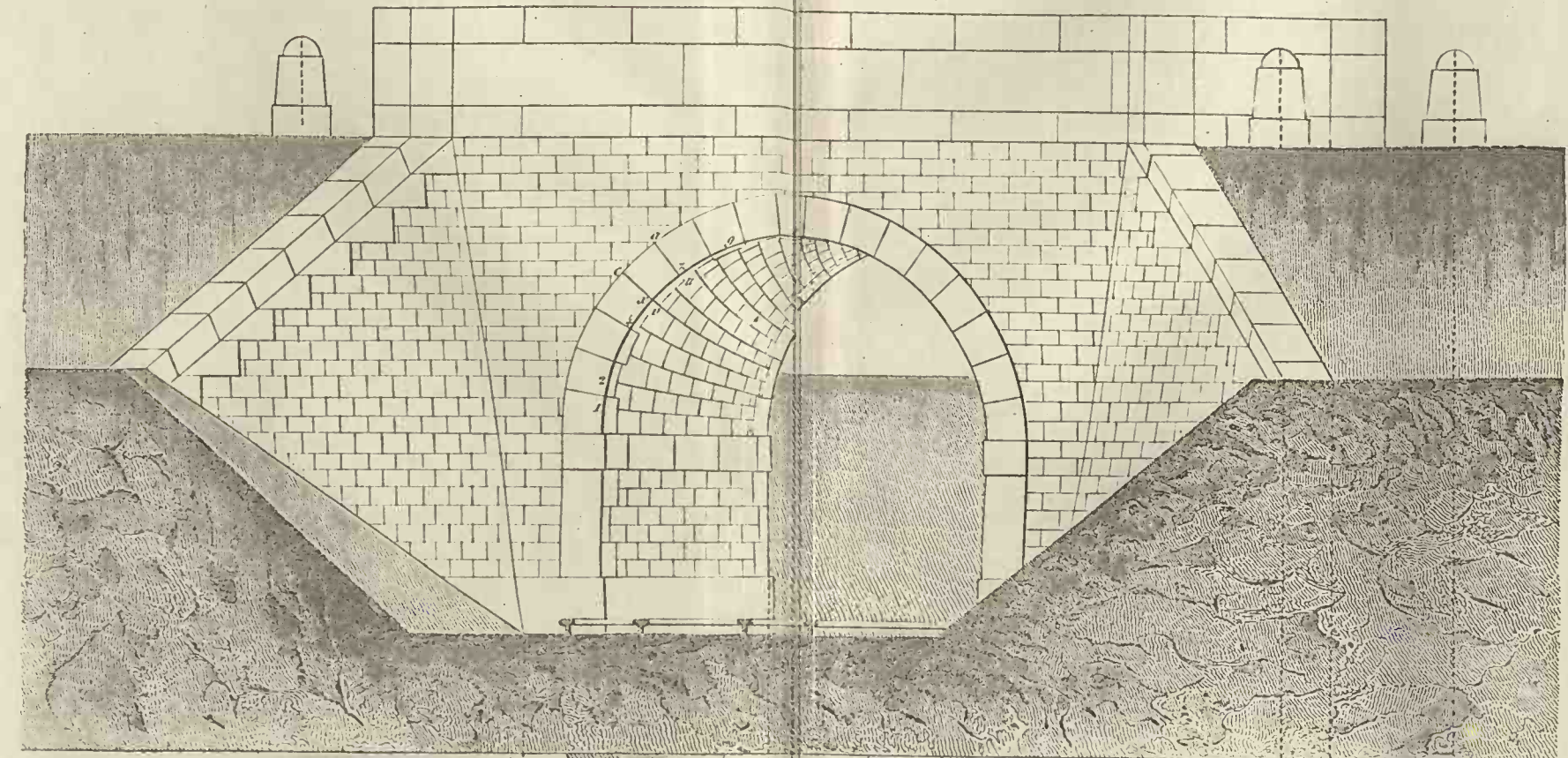

Fig. 3

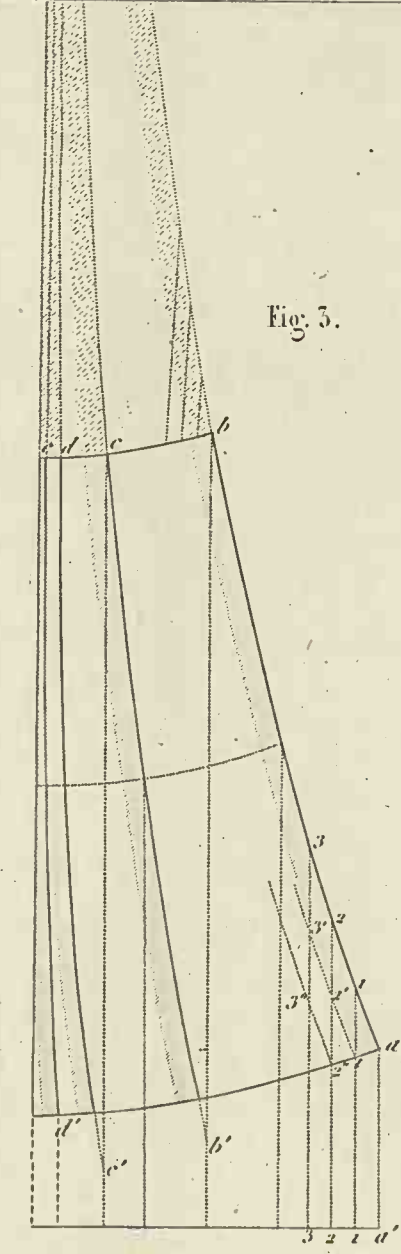

Fig. 4

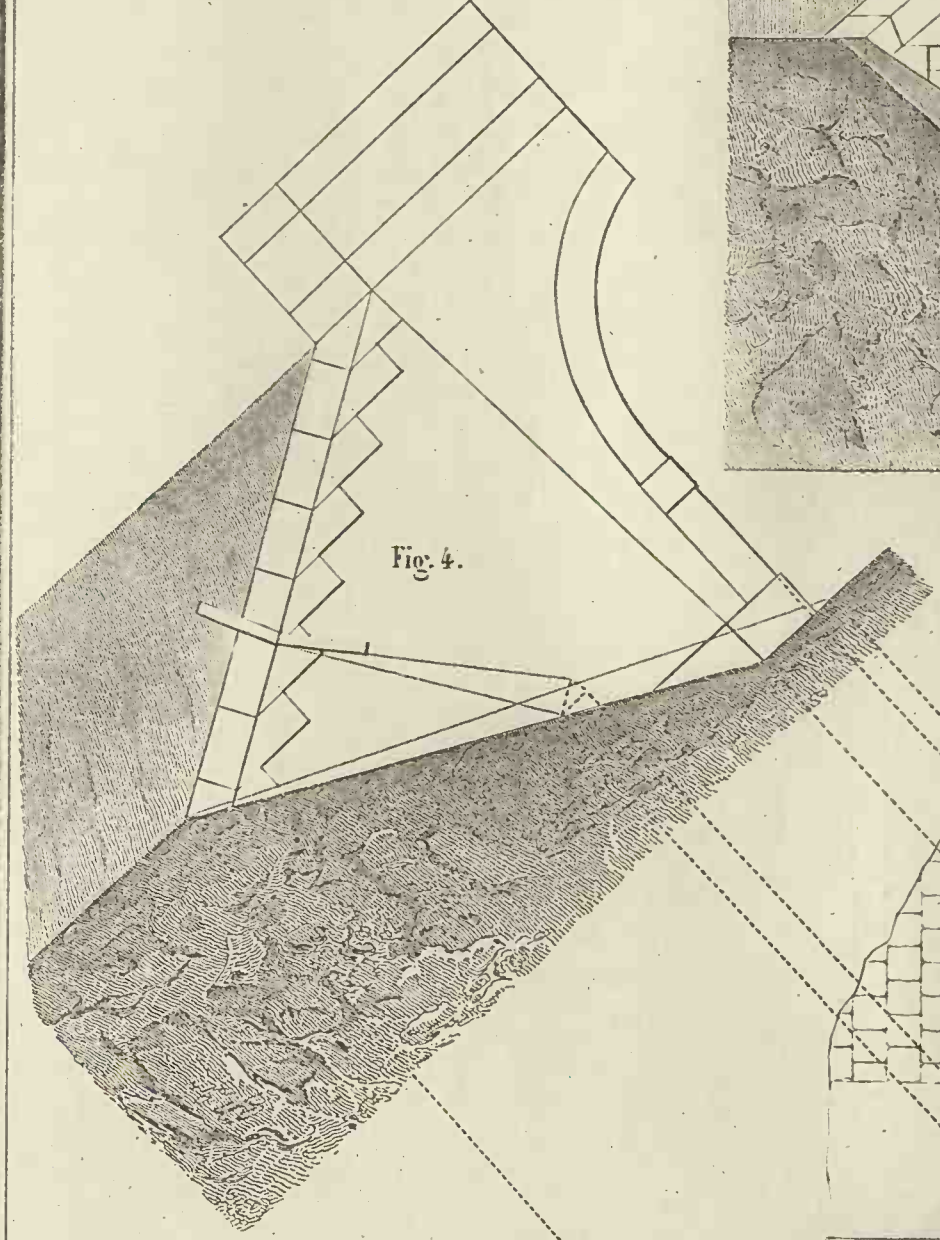

Fig. 6

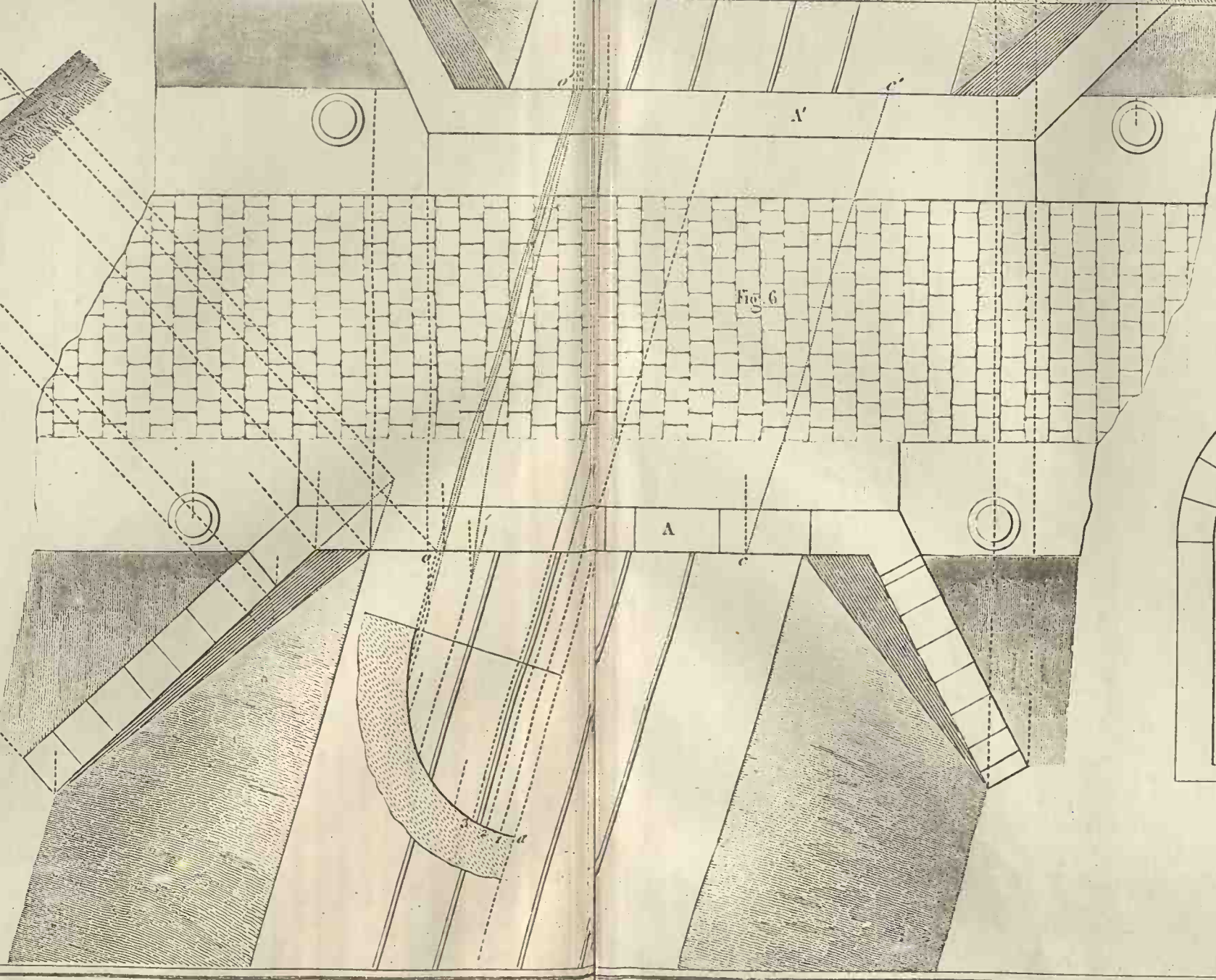

Fig. 7

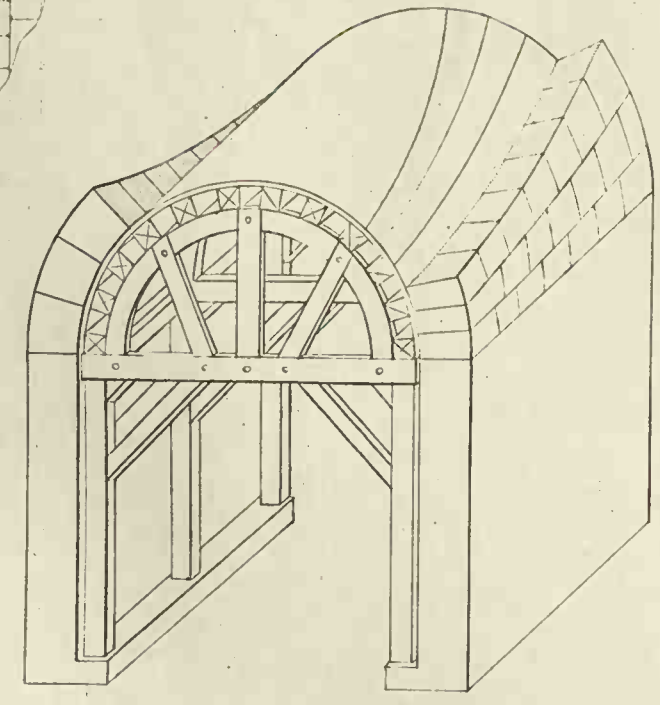
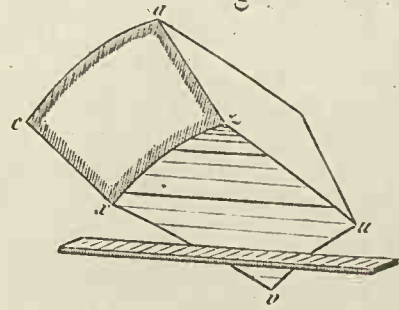
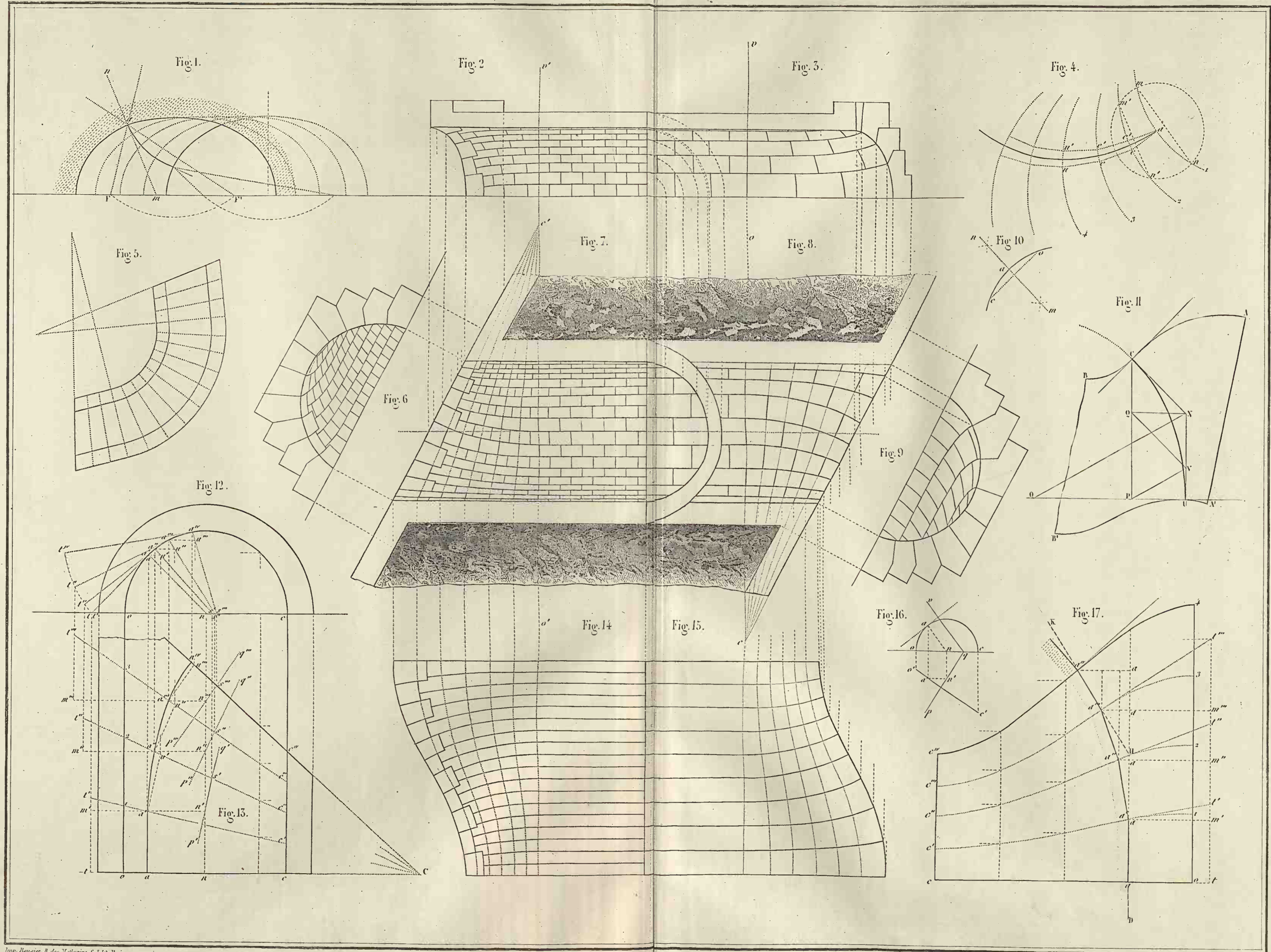

Fig. 5



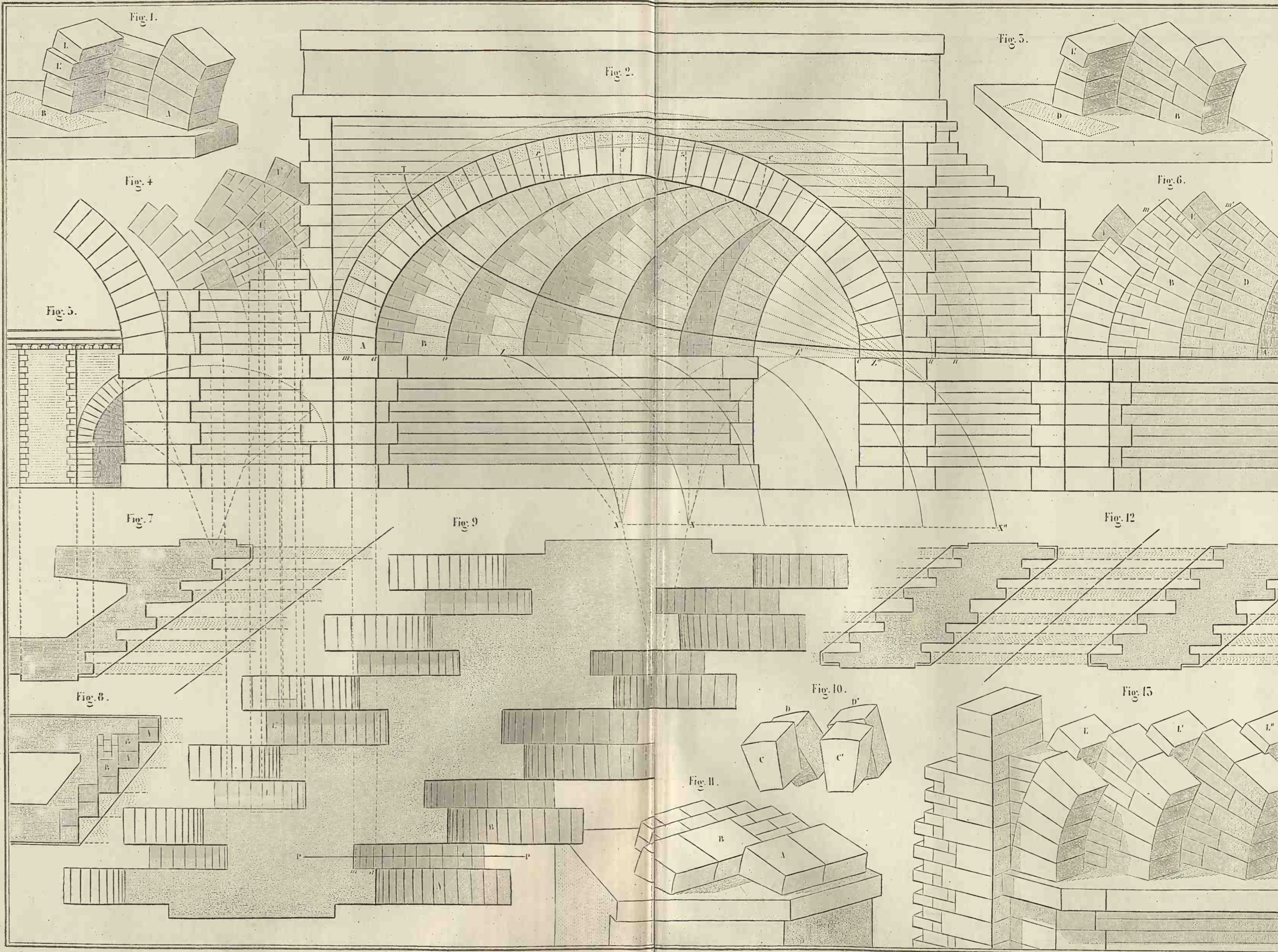



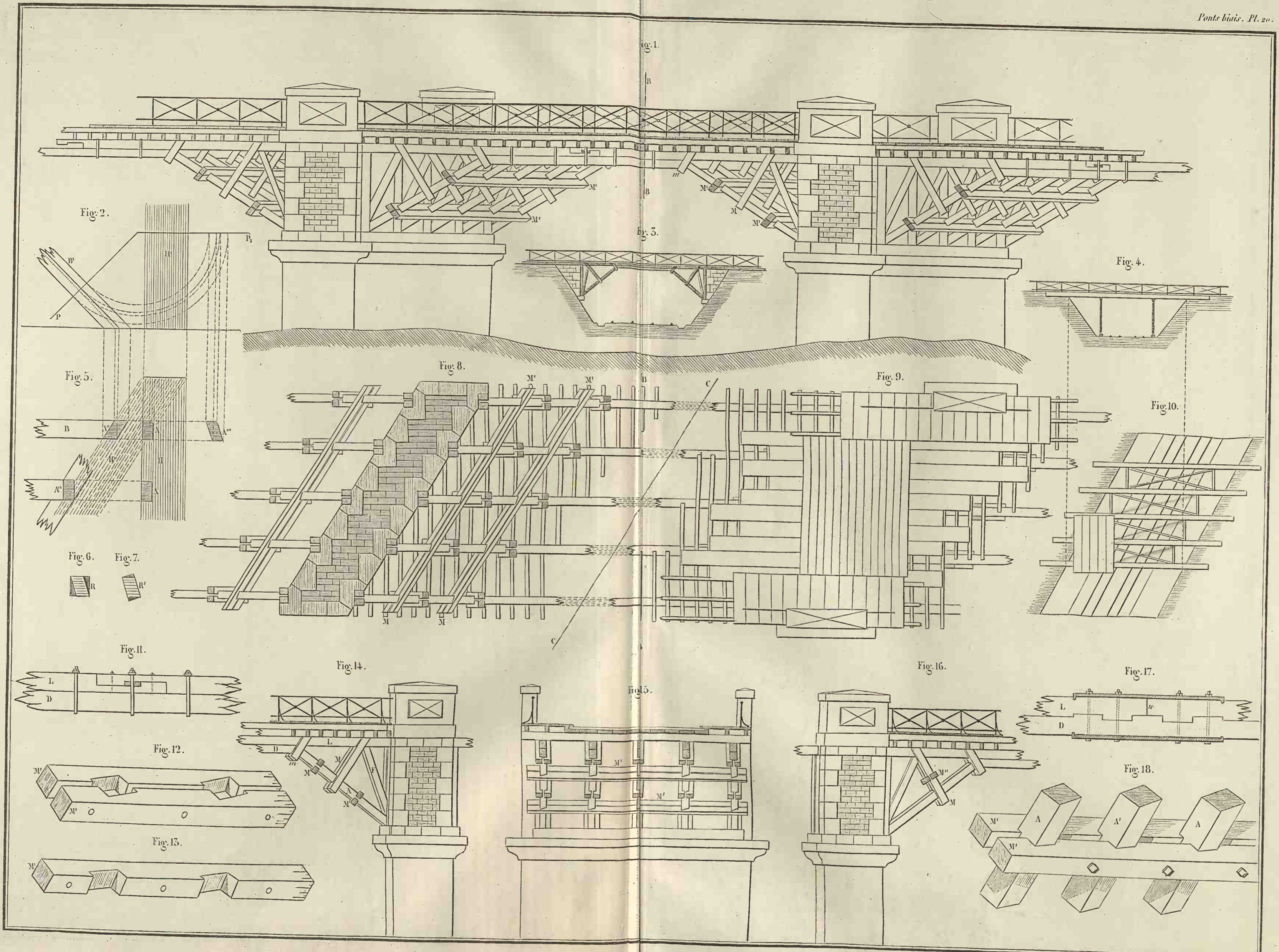



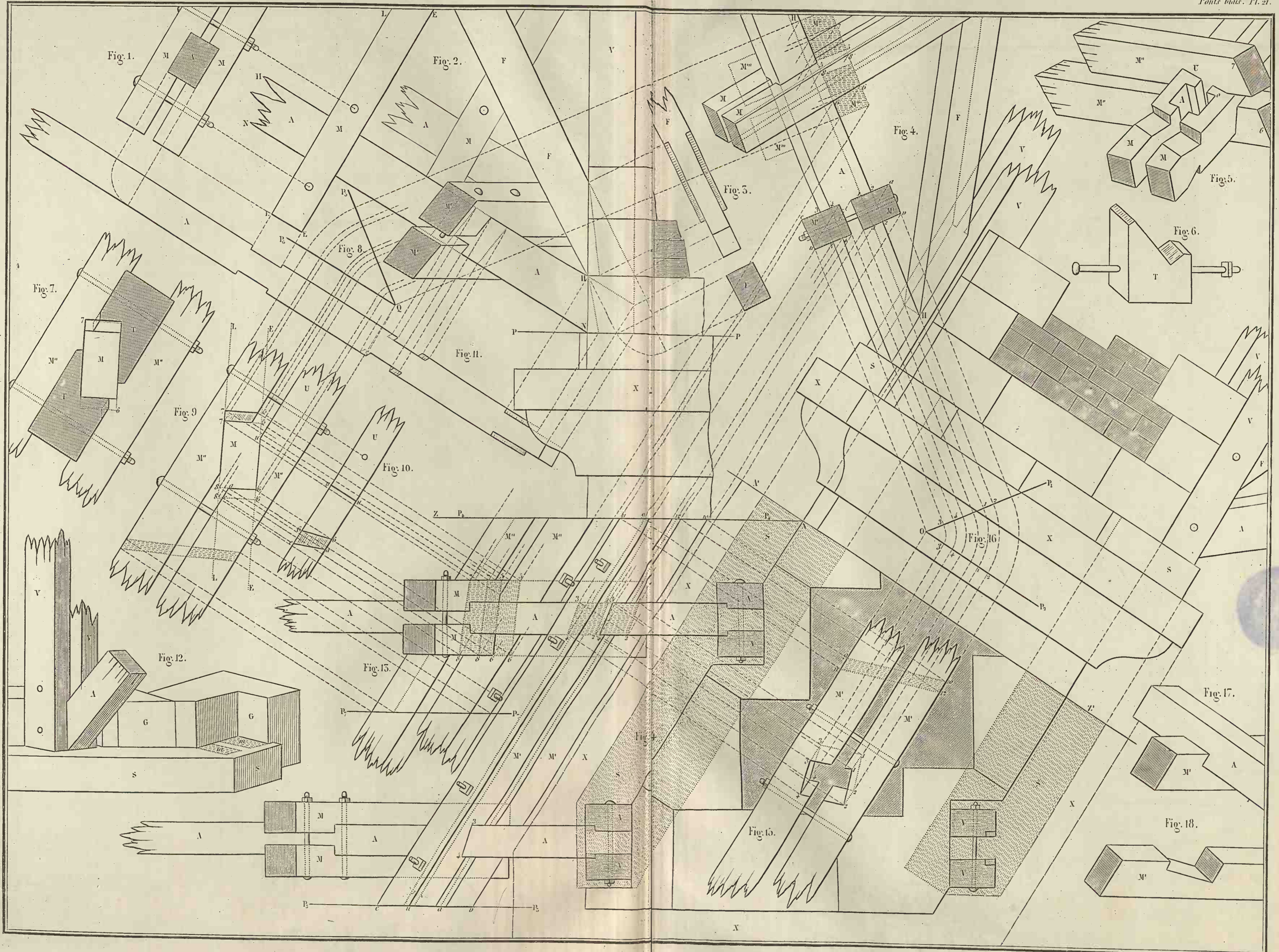













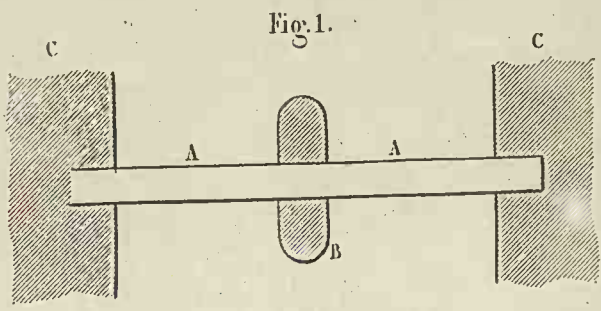

Fig. 1.

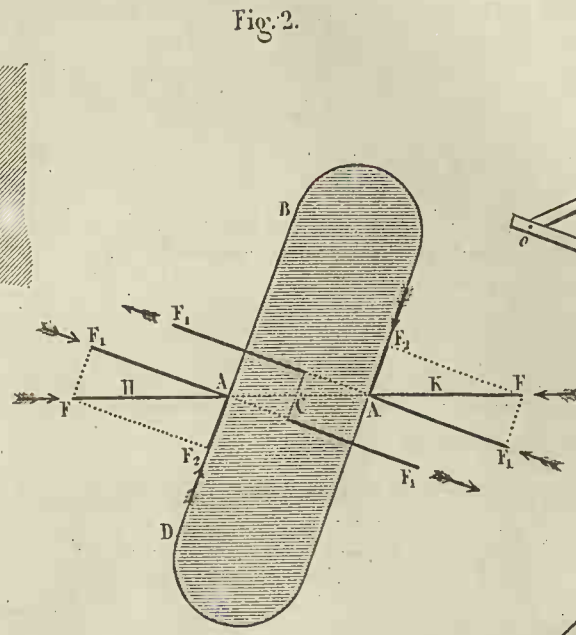

Fig. 2.

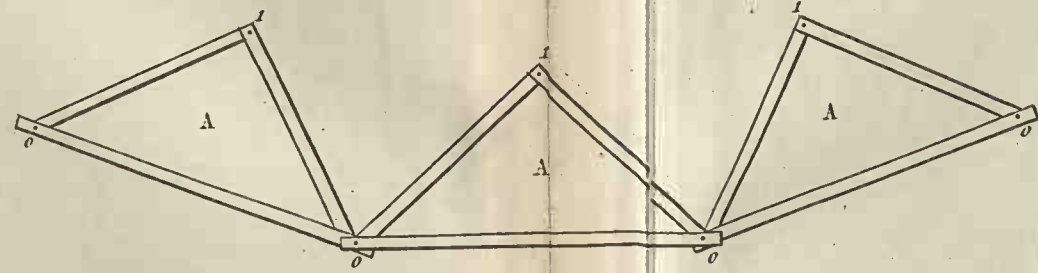

Fig. 3.

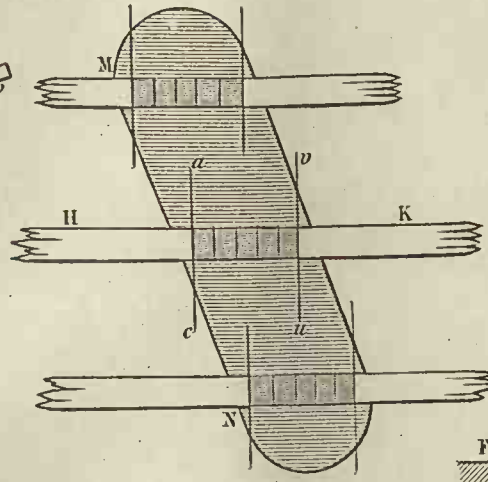

Fig. 4.

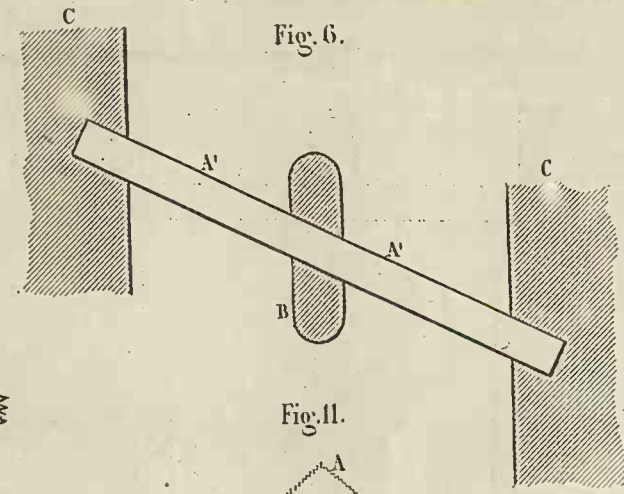

Fig. 5.

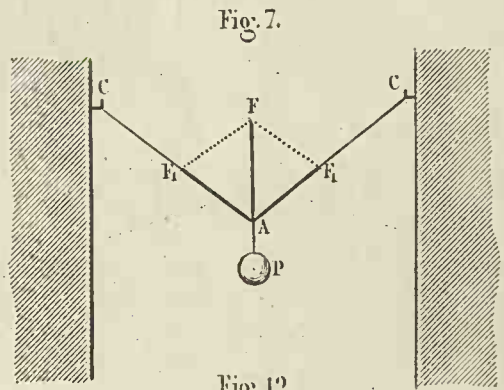

Fig. 6.

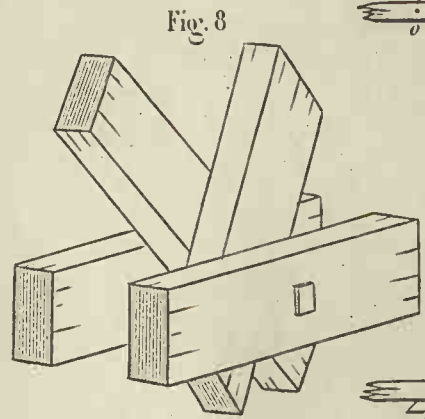

Fig. 7.

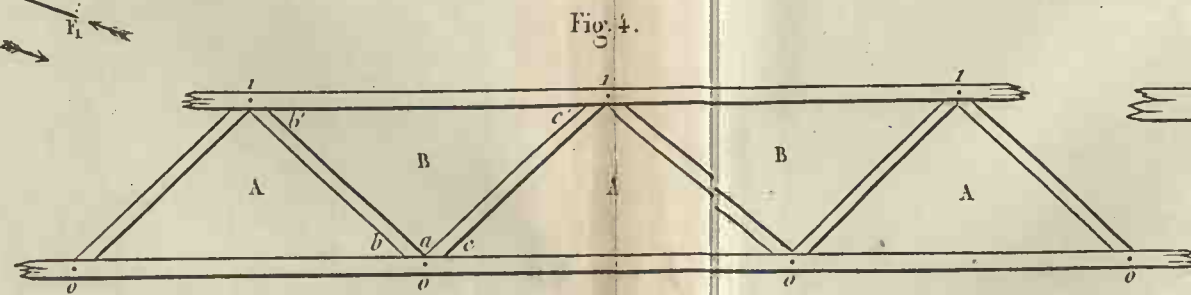

Fig. 8.

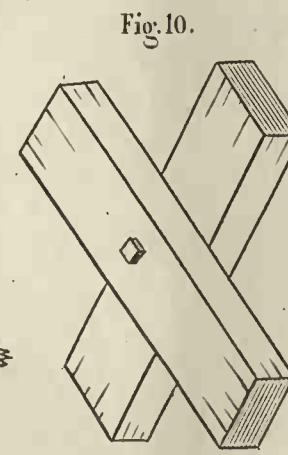

Fig. 9.

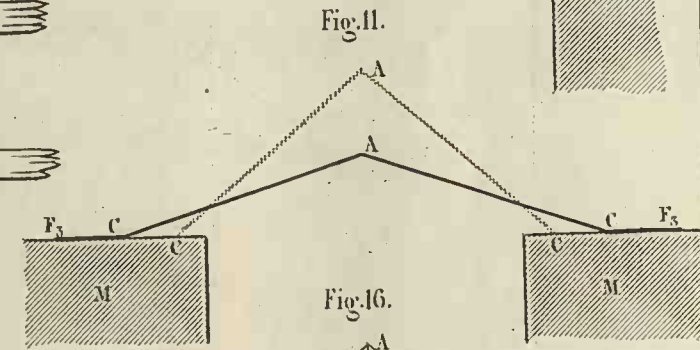

Fig. 10.

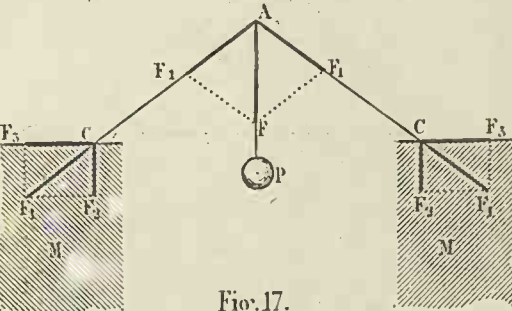

Fig. 11.

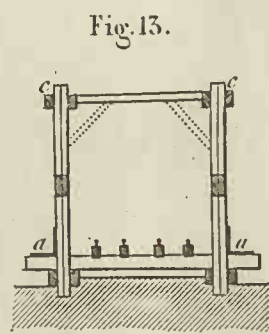

Fig. 12.

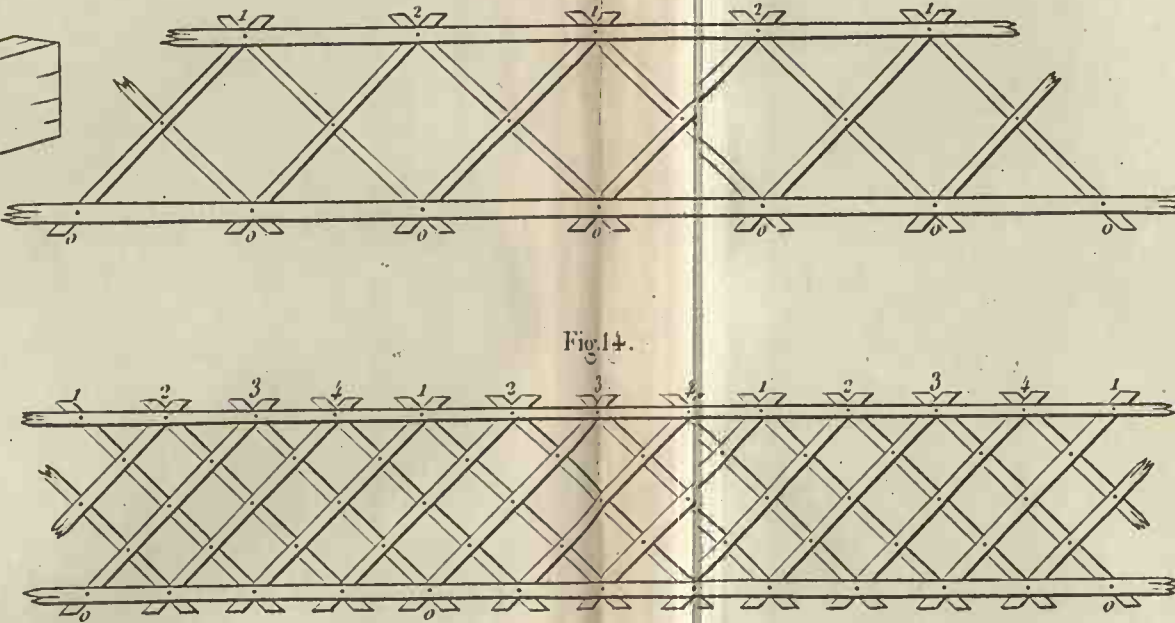

Fig. 13.

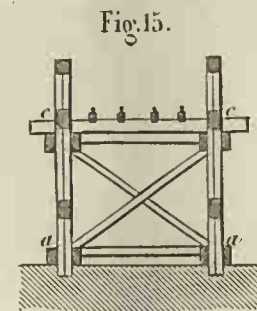

Fig. 14.

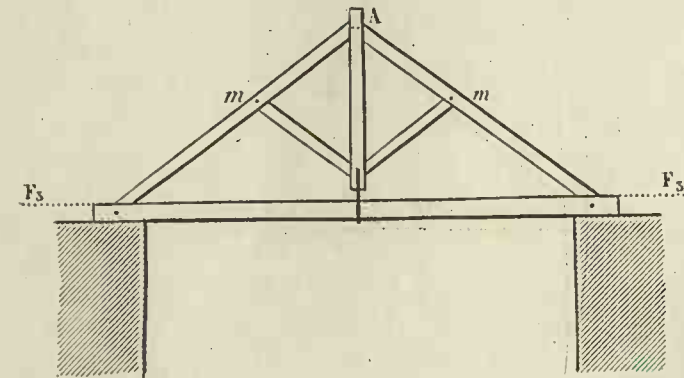

Fig. 15.

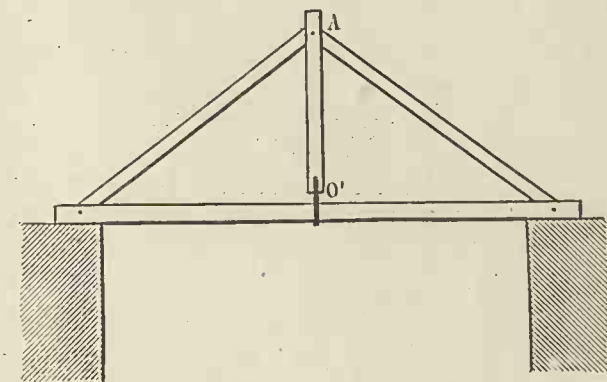

Fig. 16.

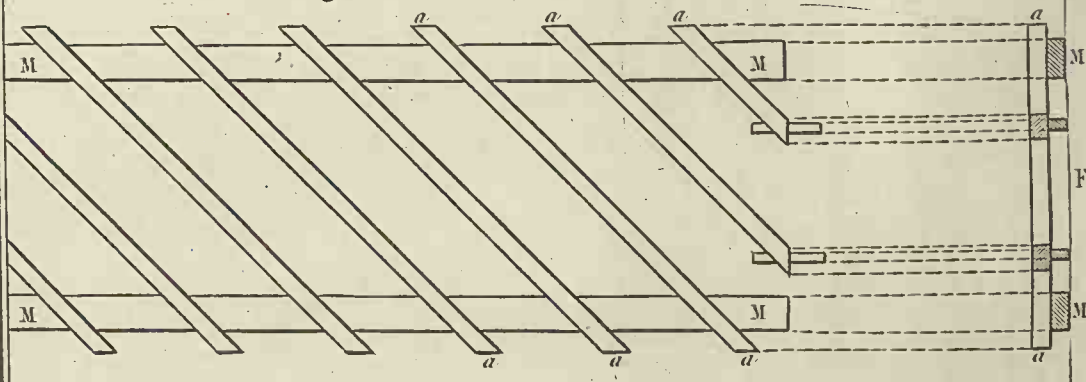

Fig. 17.

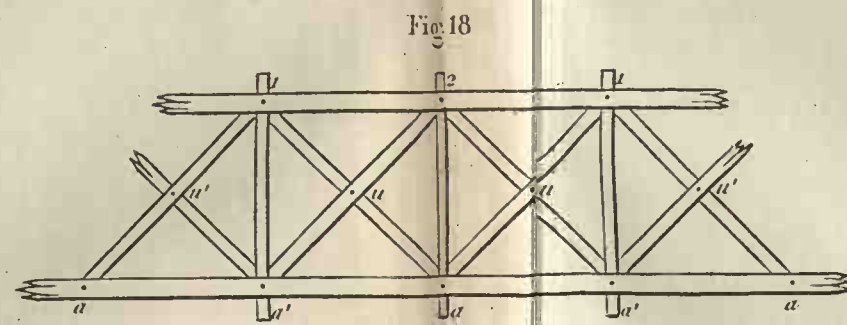

Fig. 18.

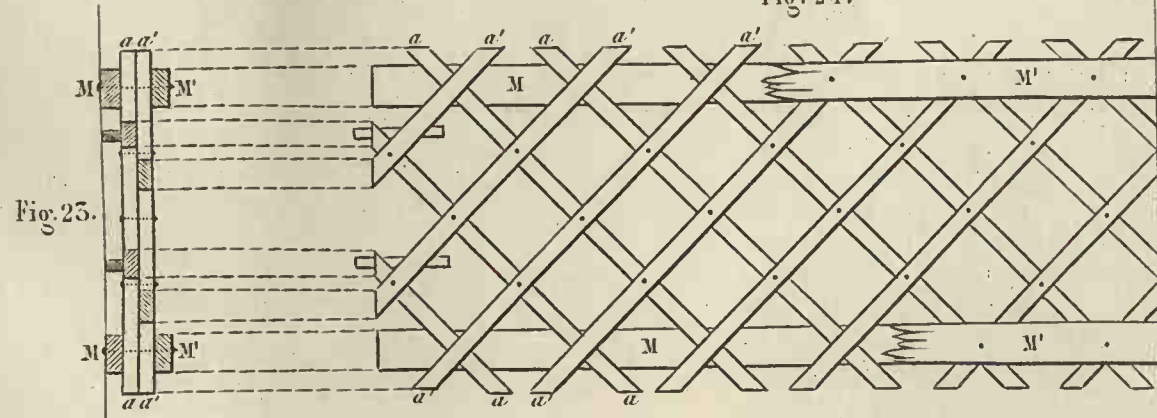

Fig. 19.

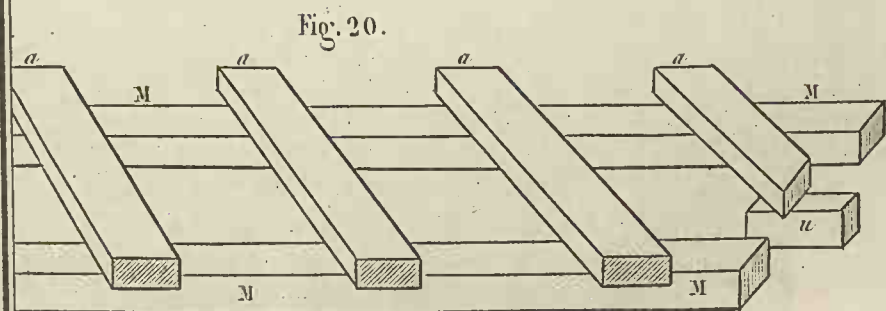

Fig. 20.

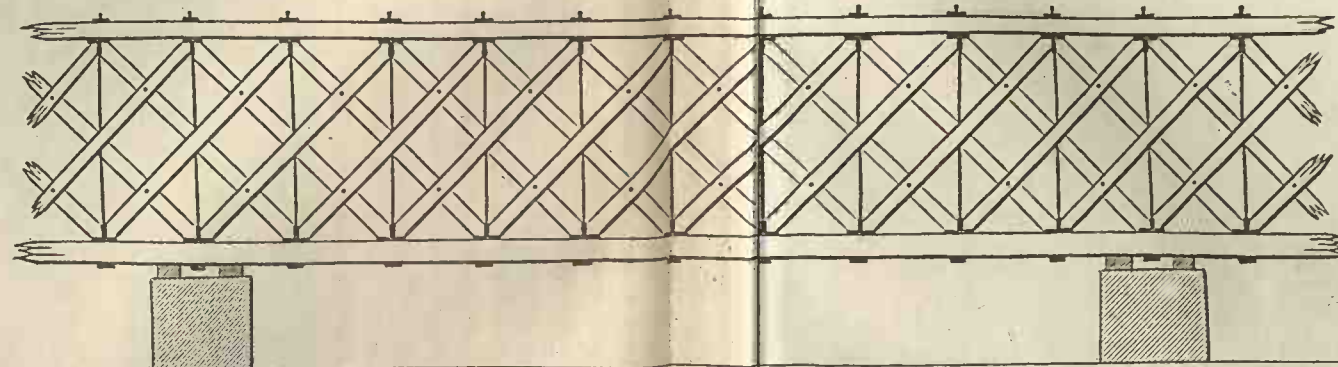

Fig. 21.

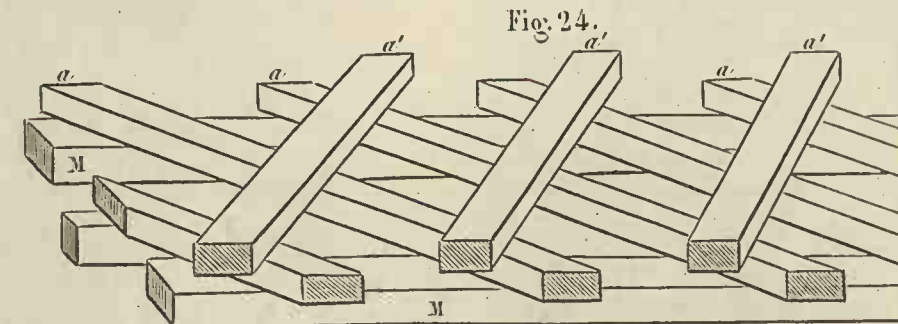
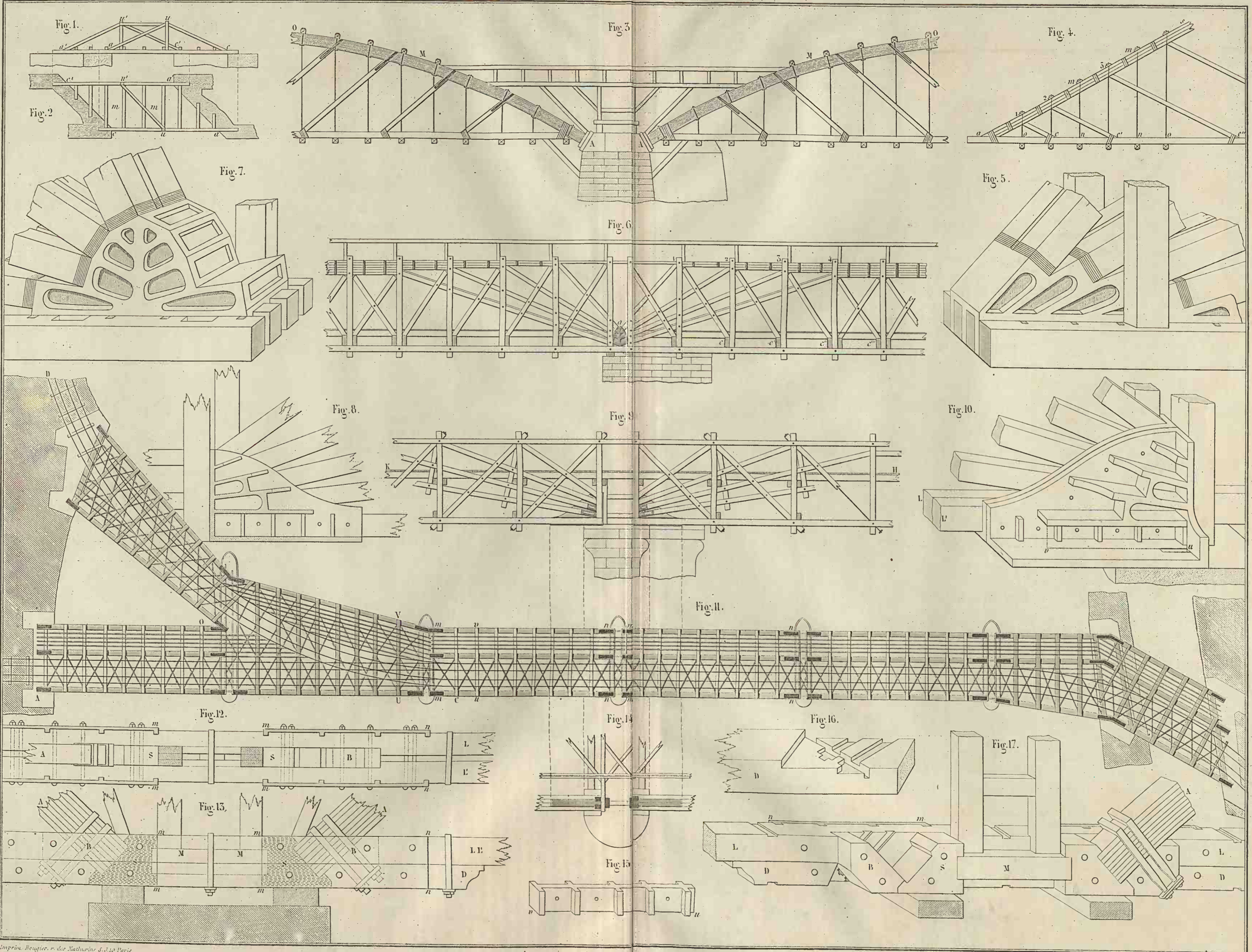
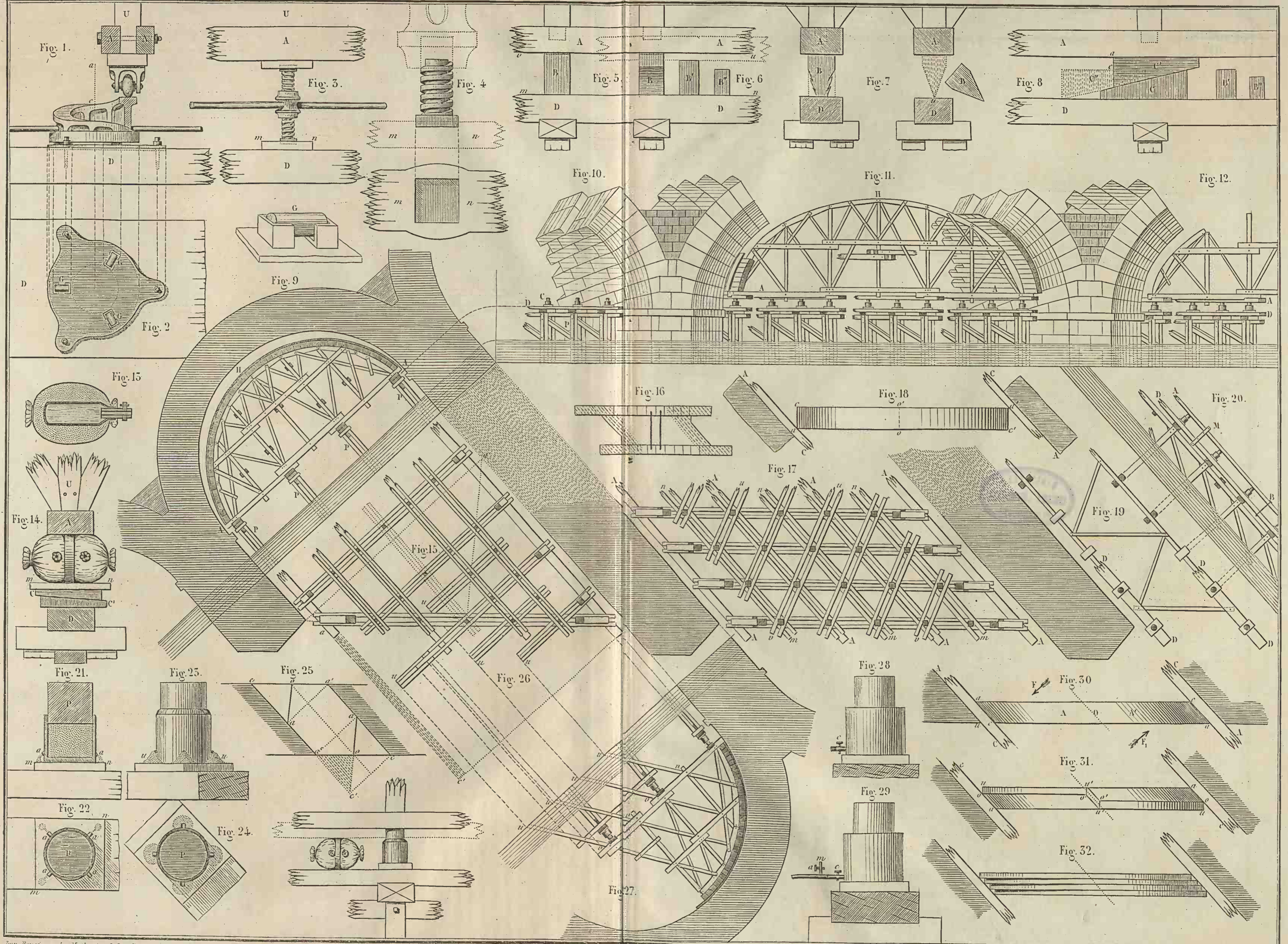

Fig. 22.











VERIFICAT  
2017

VERIFICAT  
1987

BIBLIOTECA  
CENTRALĂ UNIVERSITARĂ  
BUCUREȘTI

VERIFICAT  
2007

40959

