

COURS

DE

MATHÉMATIQUES

A L'USAGE

DES ARCHITECTES, INGÉNIEURS CIVILS, ETC.

PAR J. ADHÉMAR



APPLICATIONS DE GÉOMÉTRIE DESCRIPTIVE

OMBRES

328/183

[Tom 5]

Quatrième Édition

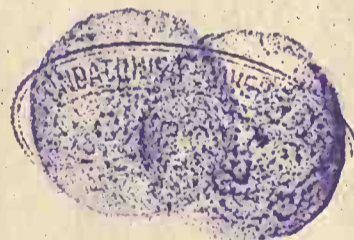

PARIS

ARMAND COLIN & C^{ie}, ÉDITEURS

16, RUE DE CONDÉ, 16

1874

33

1961

L

18651
24559

1956

MA THEMATIC

20115/06



B.C.U. Bucuresti
C24559



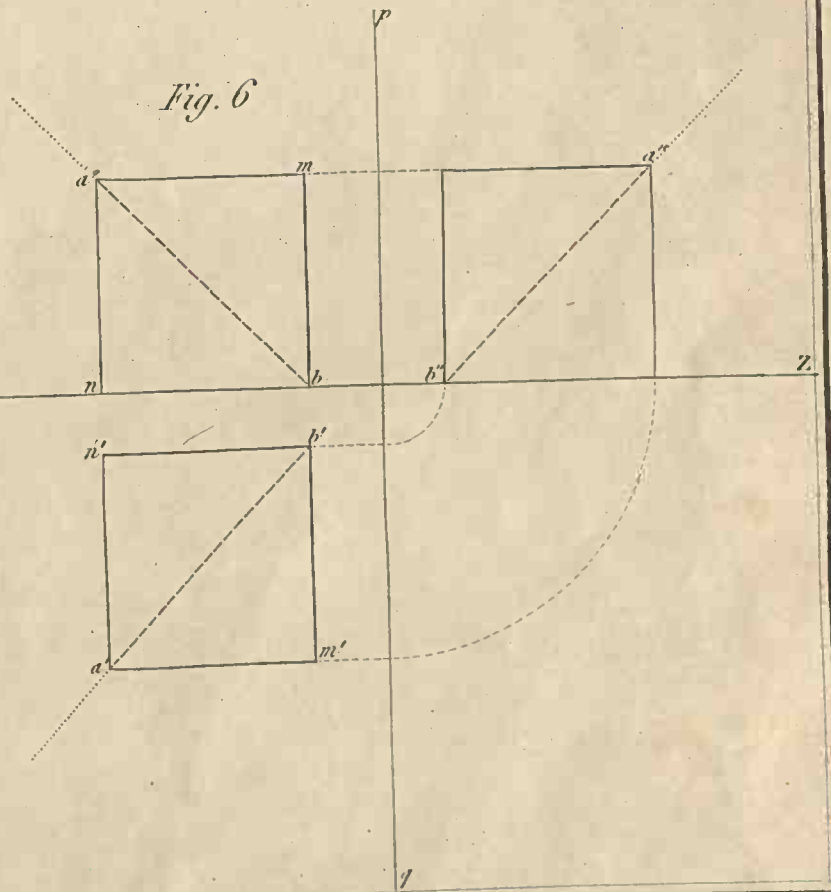
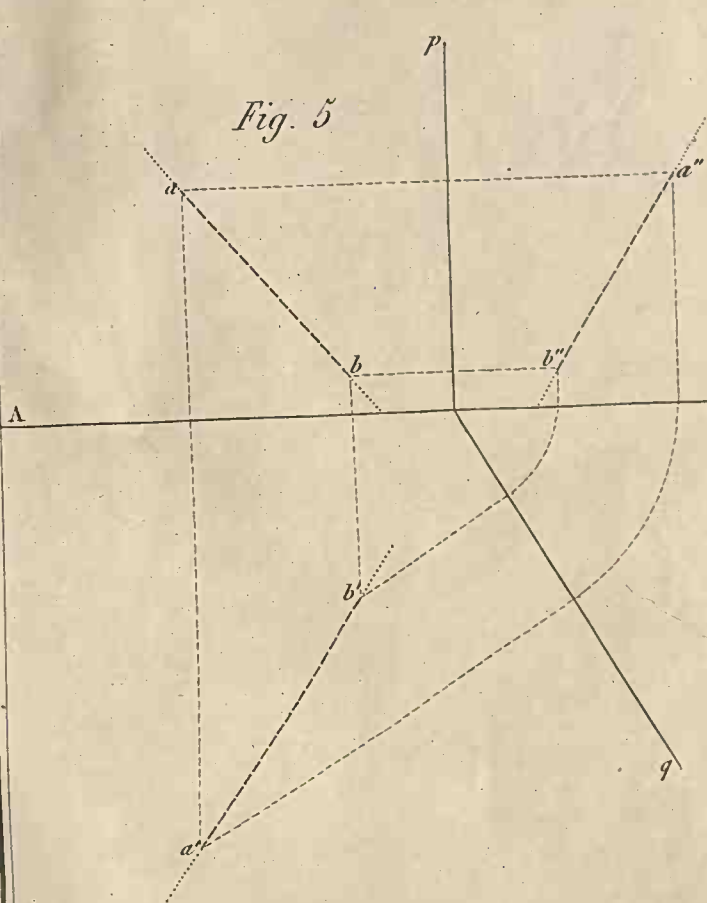
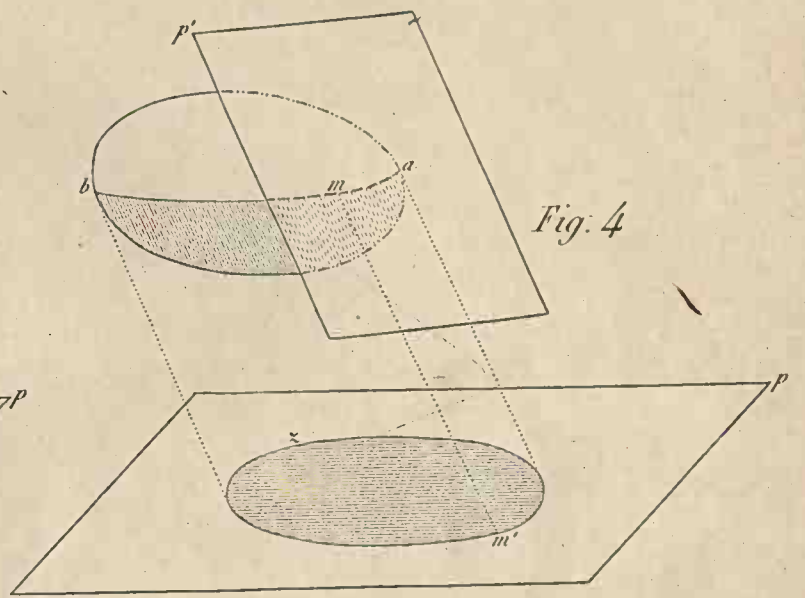
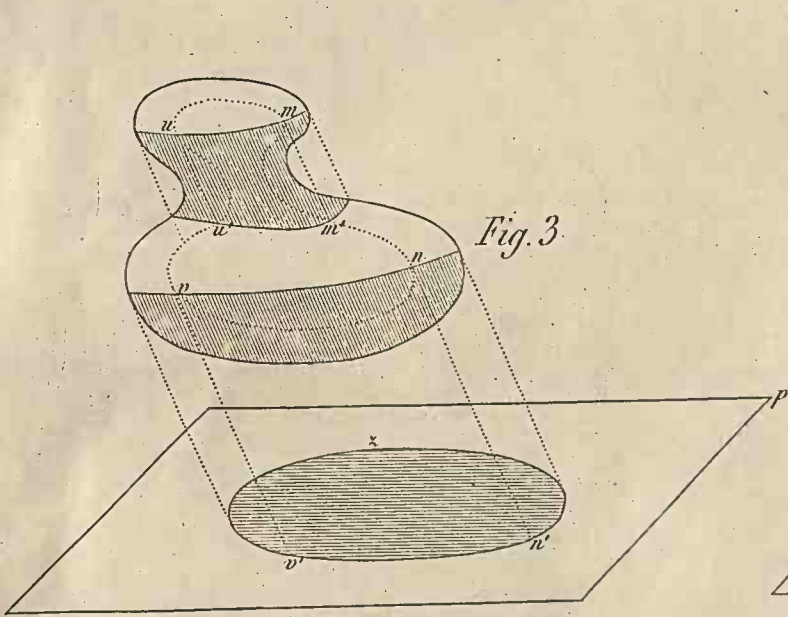
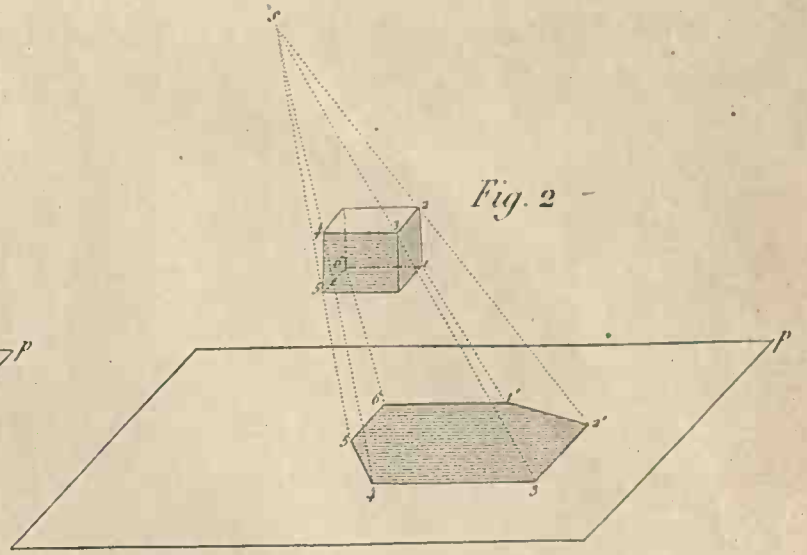
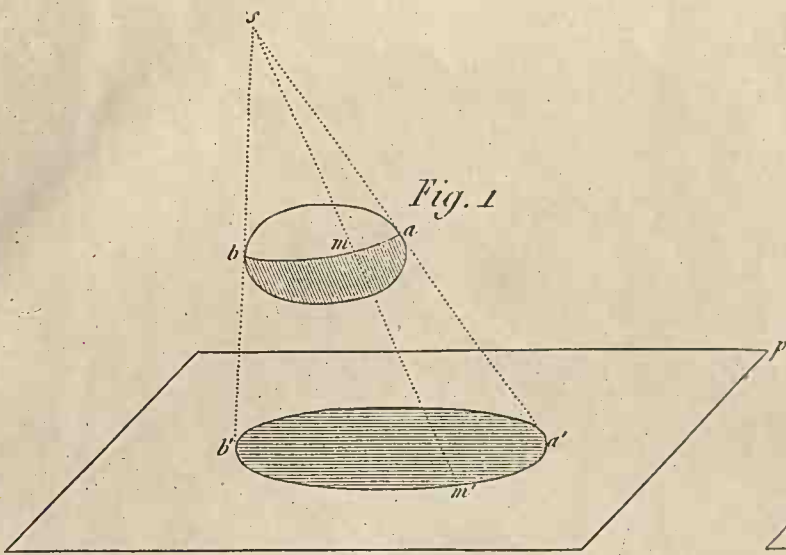

Fig. 7

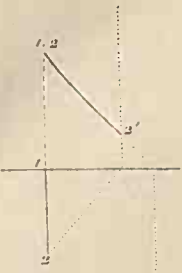

Fig. 8

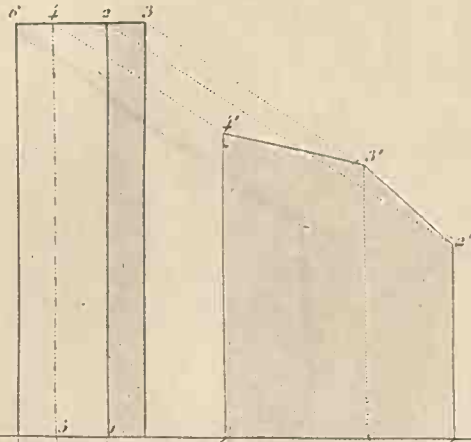

Fig. 9

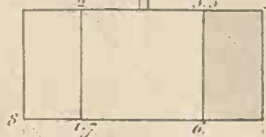
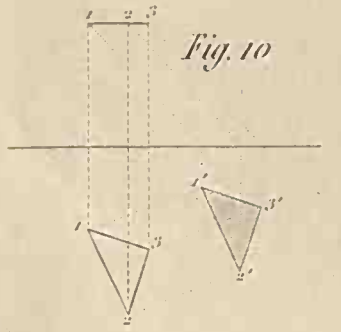
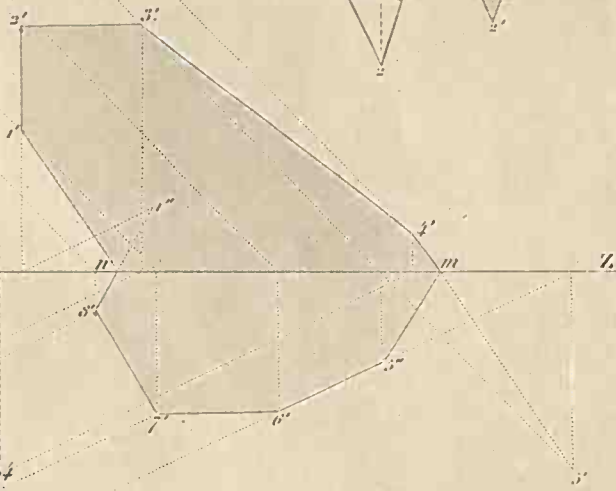
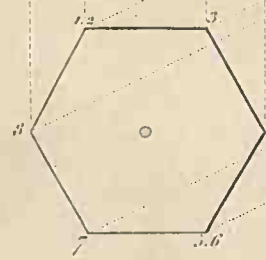
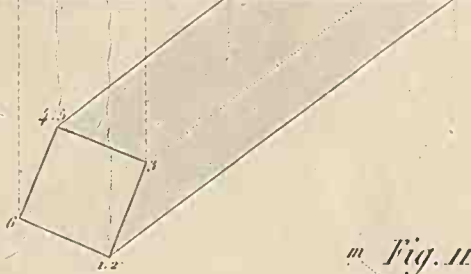

Fig. 10



A

Z



m Fig. 11

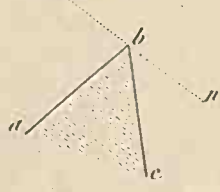

m Fig. 12



F

Fig. 13

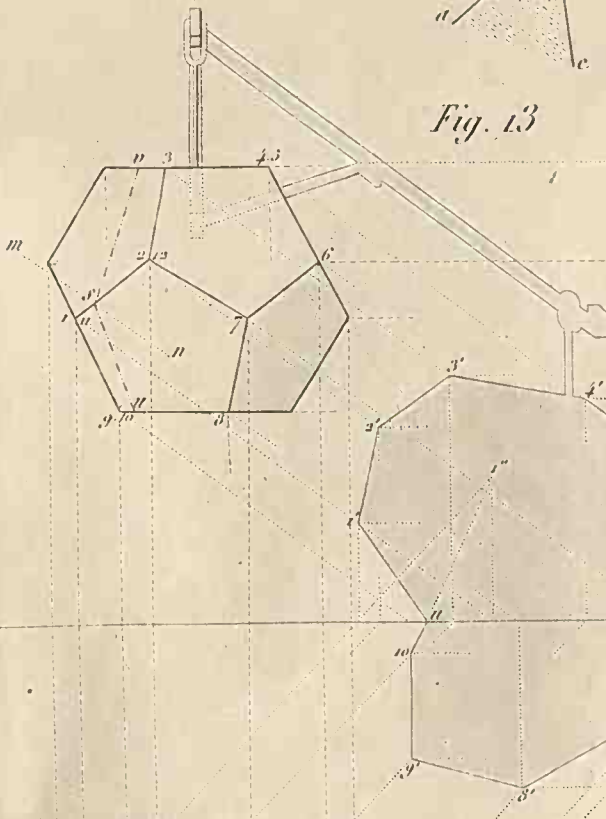

Fig. 14

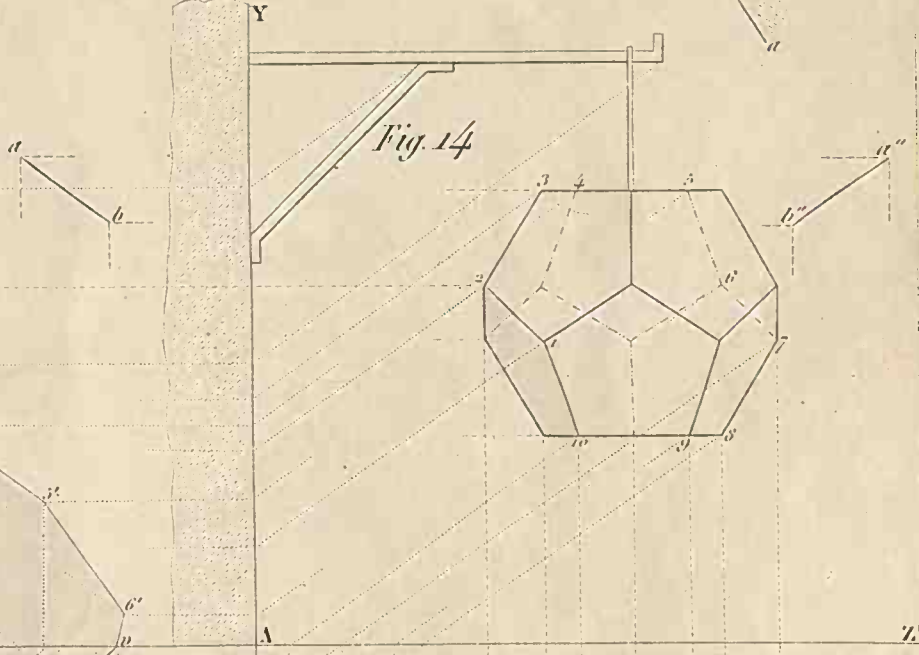
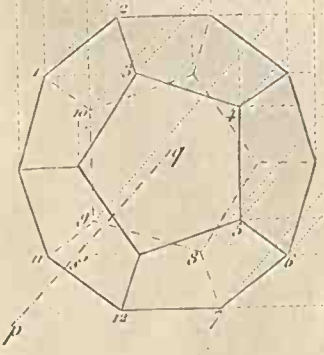
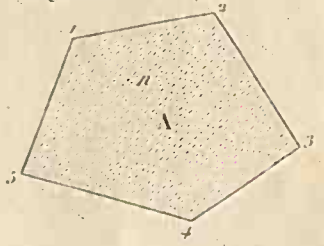

Fig. 15



m Fig. 16



Z

Z'

Z'

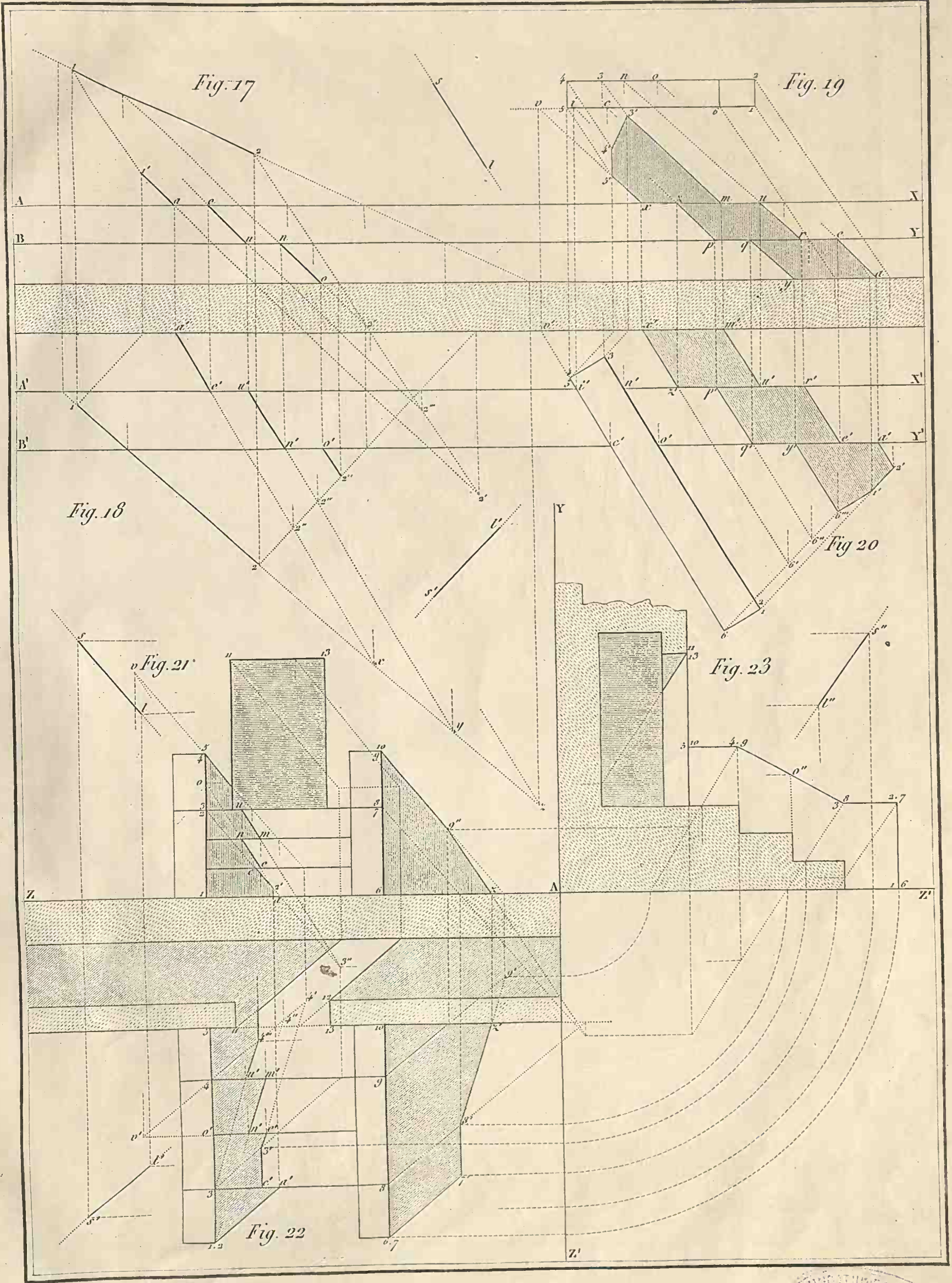

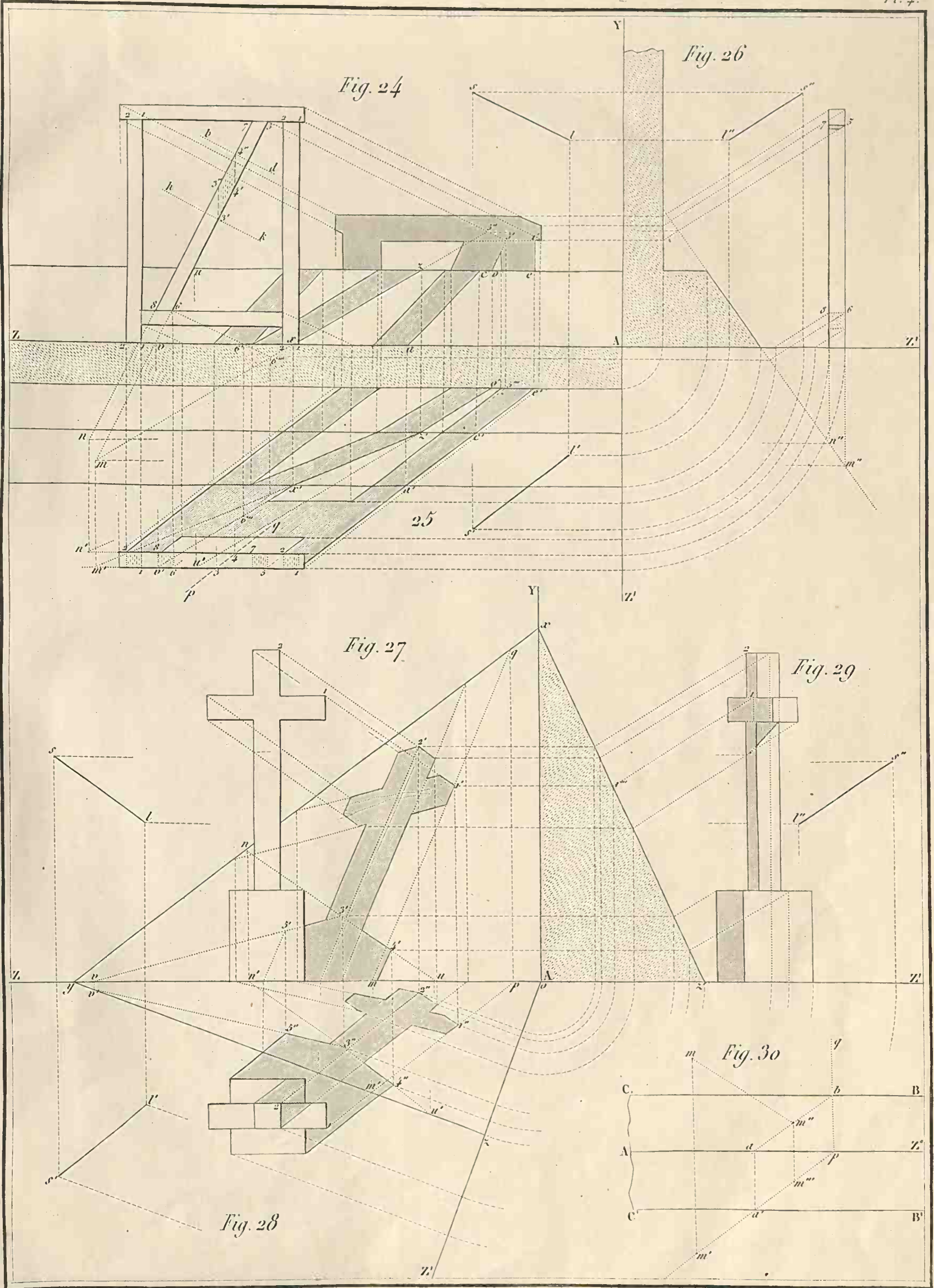

Fig. 31

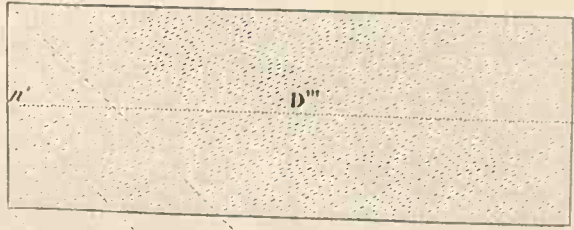

Fig. 32

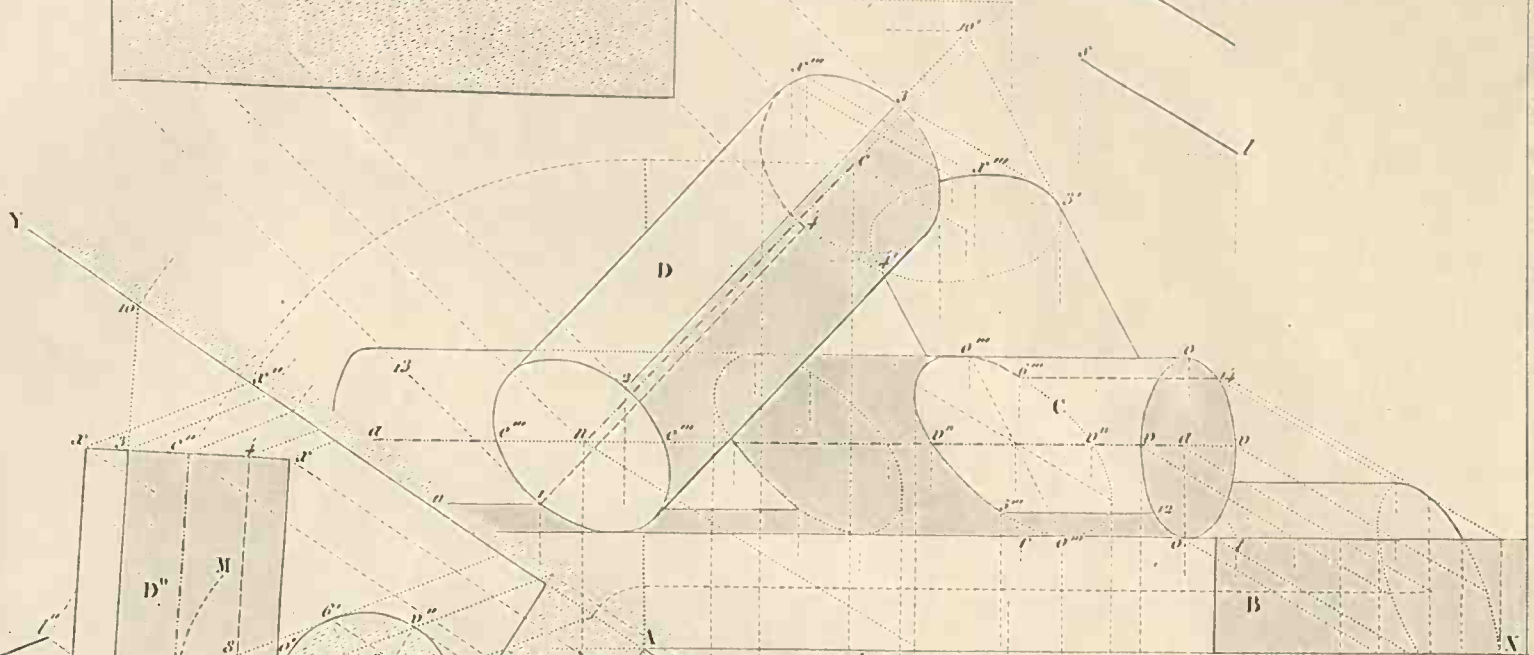

Fig. 33

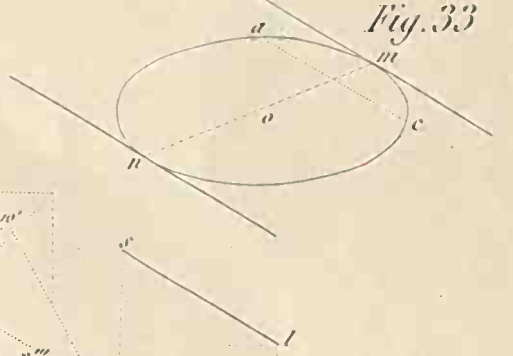

Fig. 34

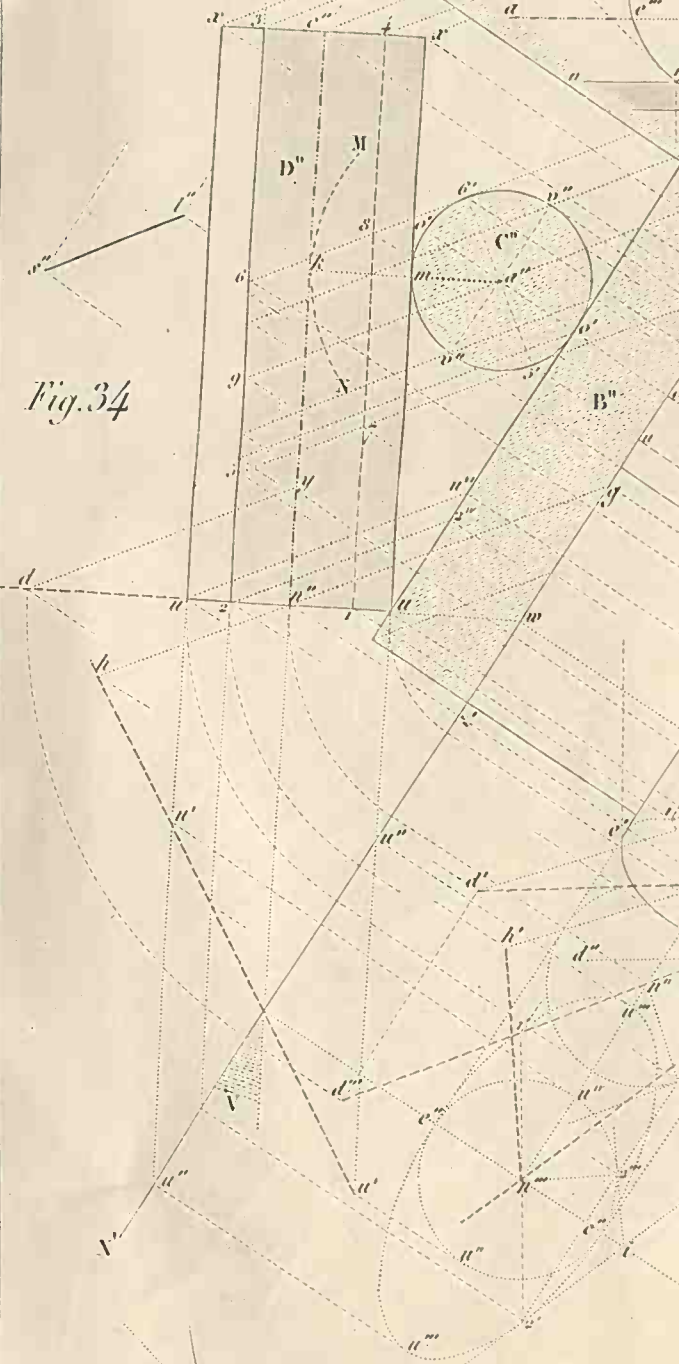

Fig. 35

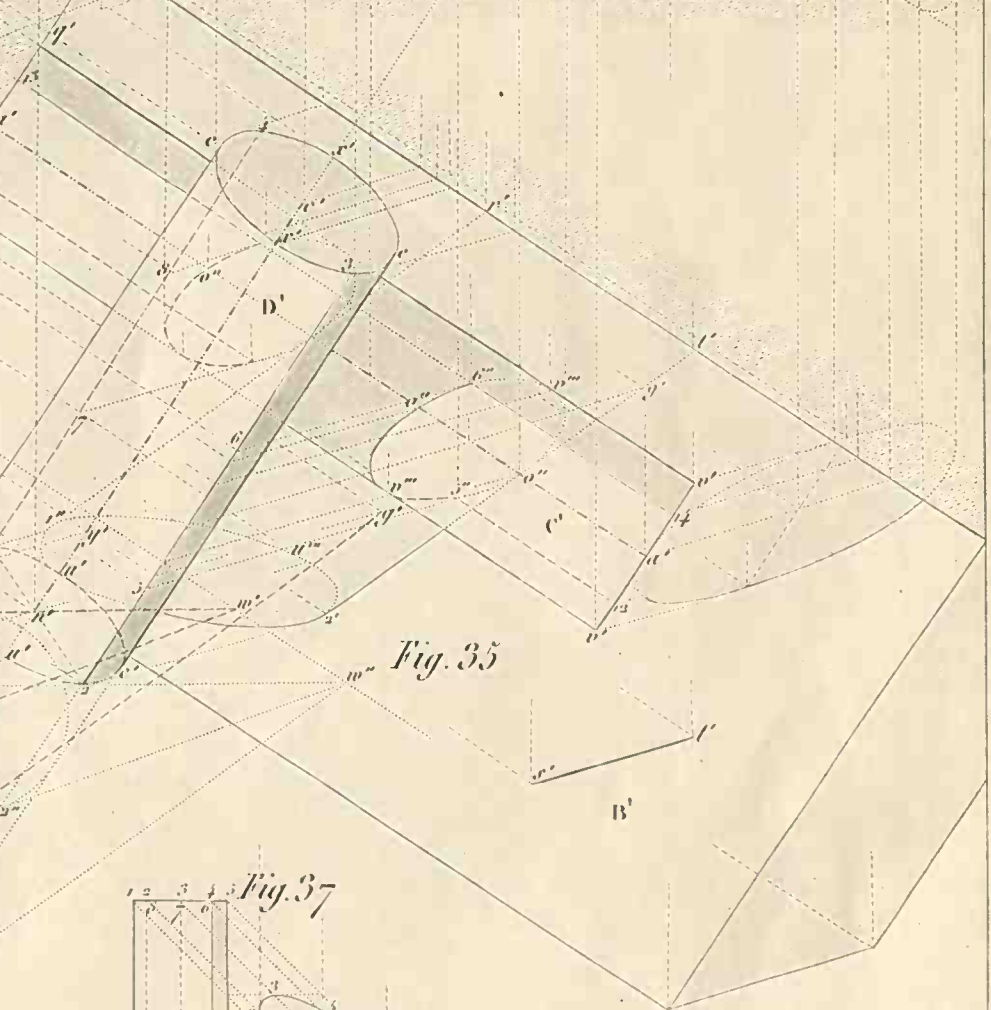

Fig. 36



Fig. 37

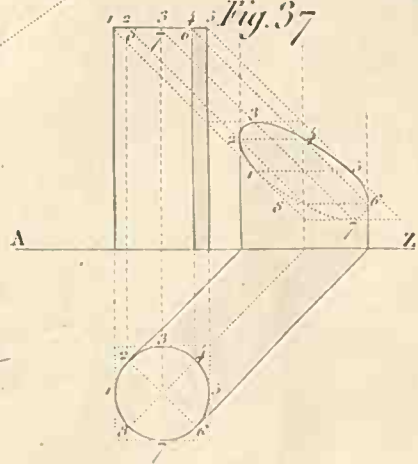
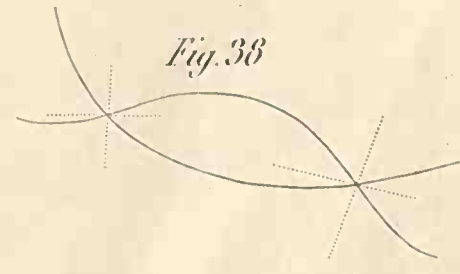
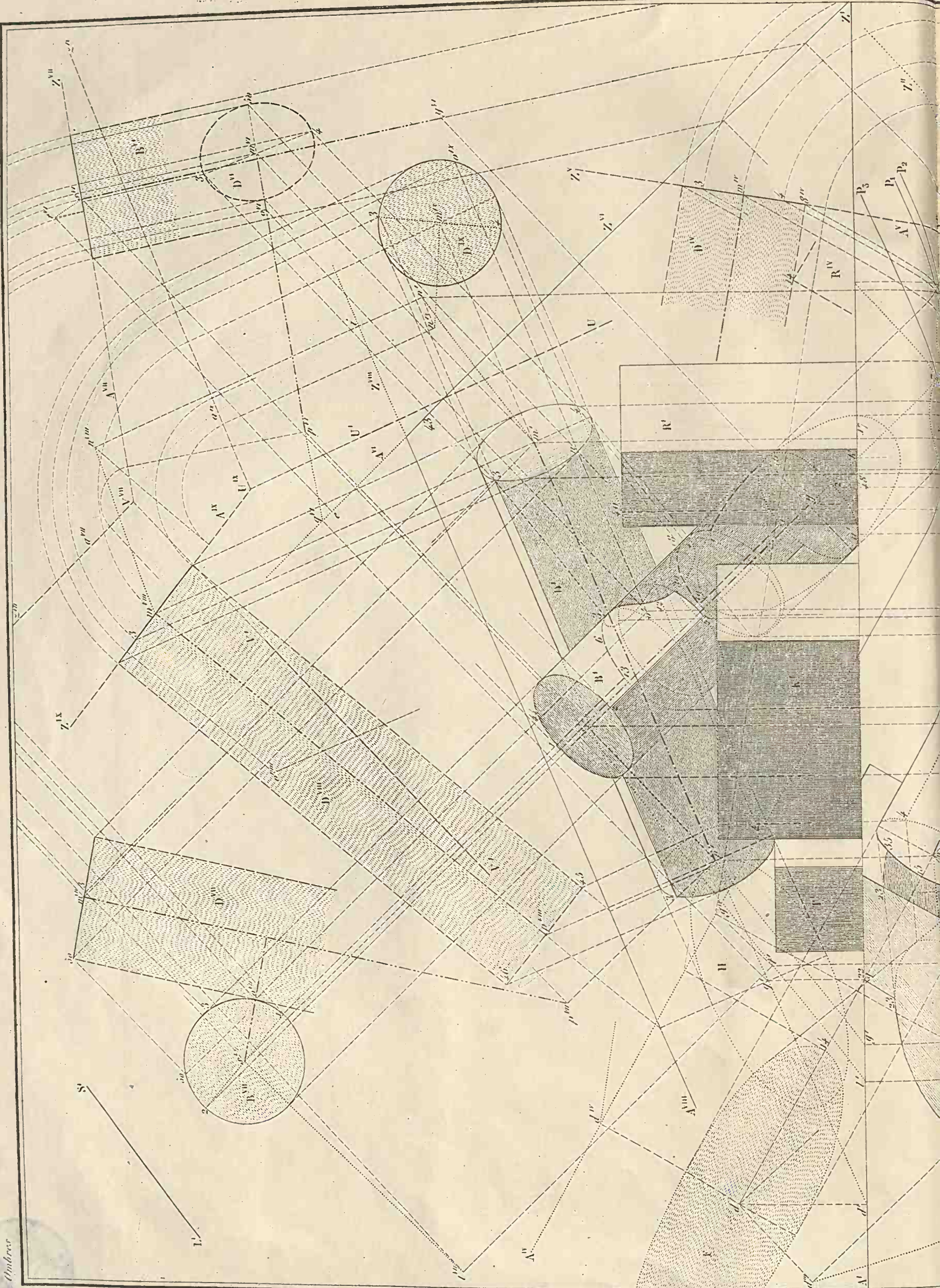
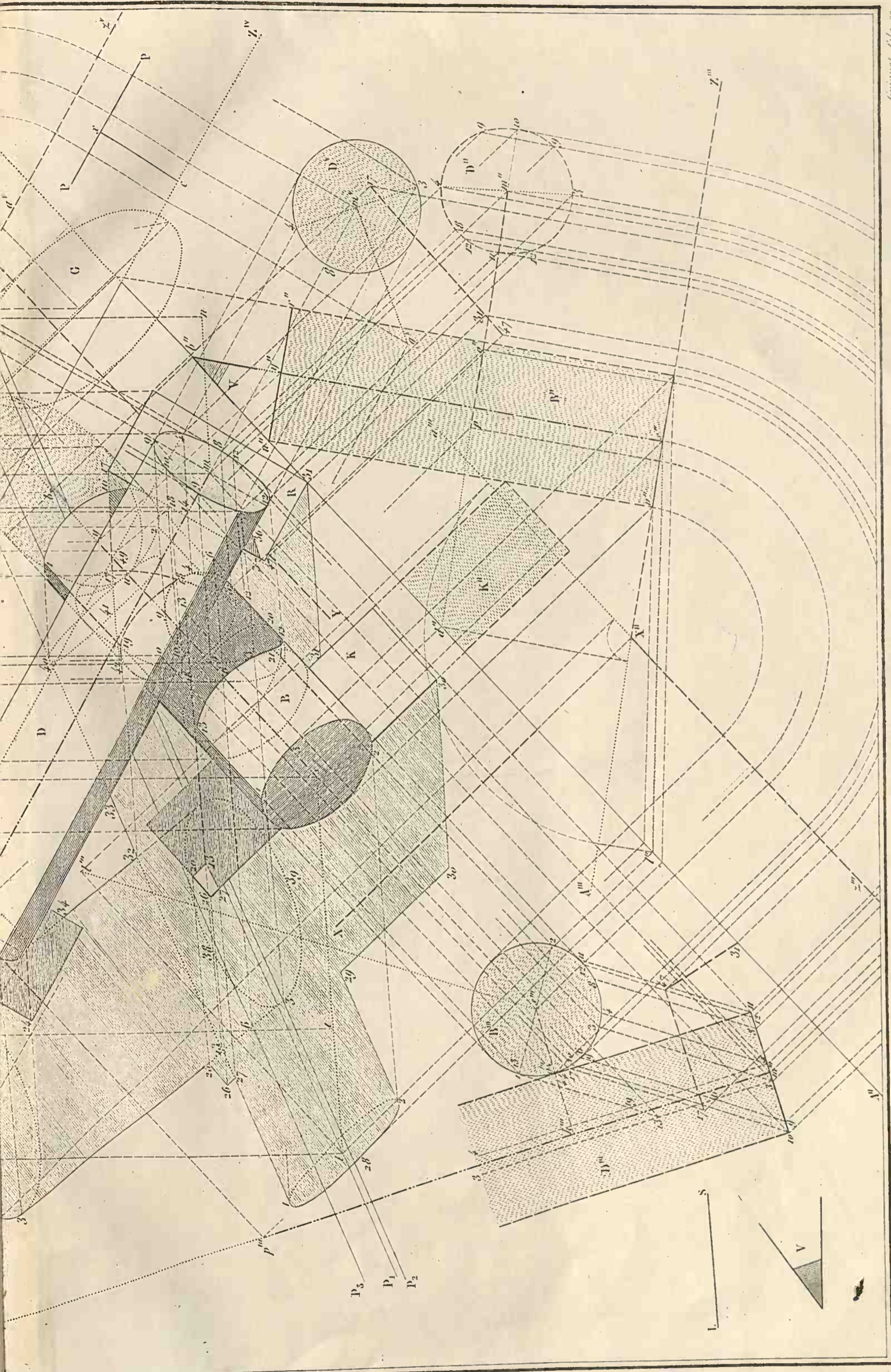

Fig. 38





ombres



Guignot, fils, sc.

Adhémar del.

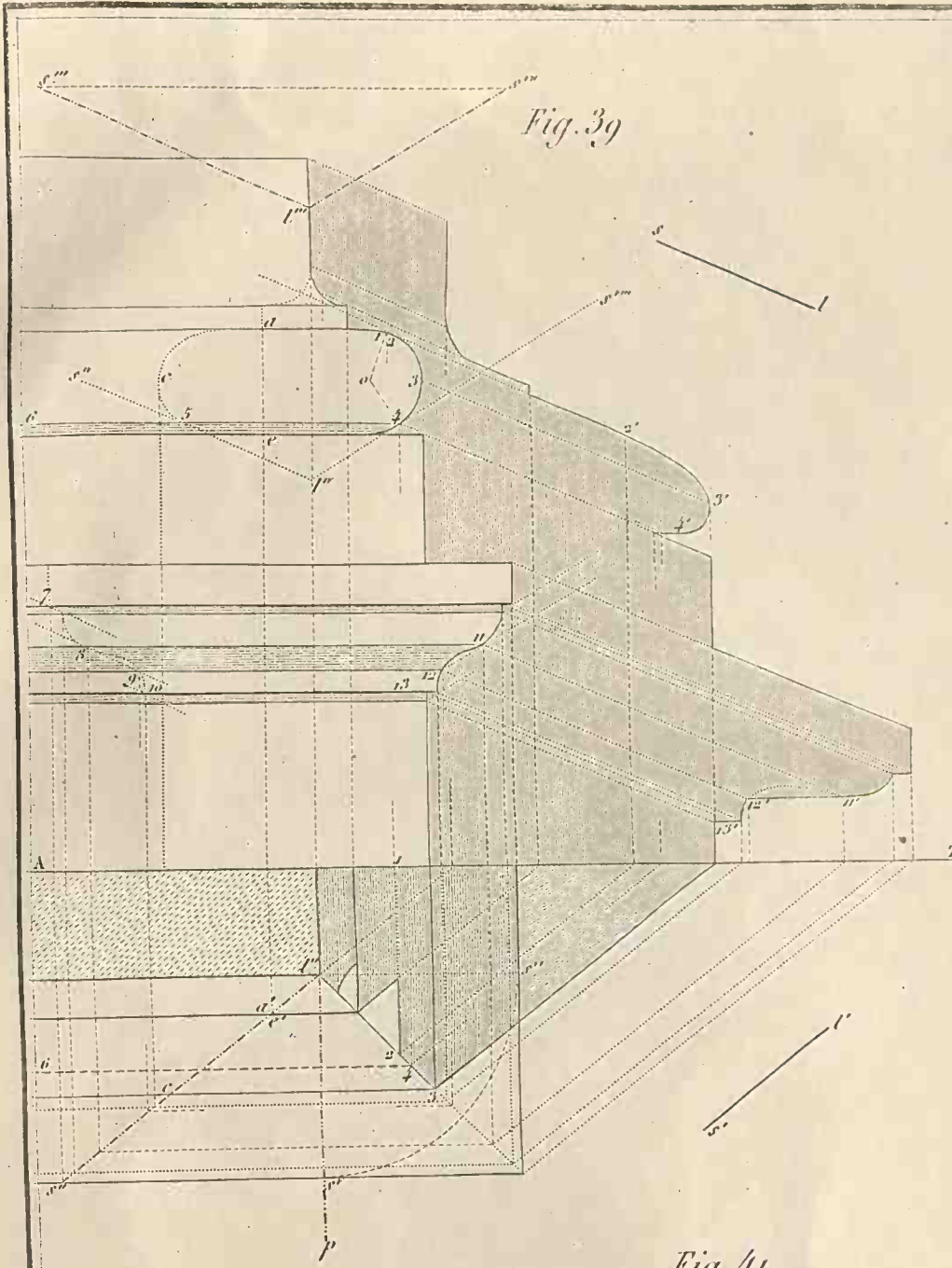

Fig. 39

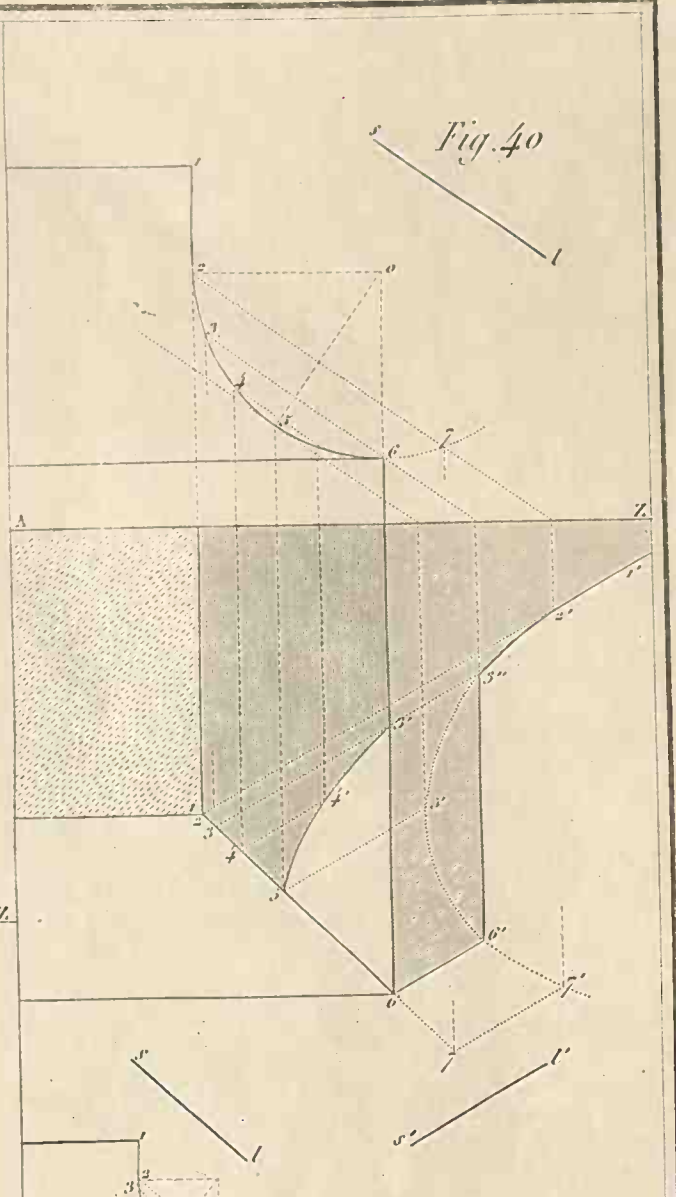

Fig. 40

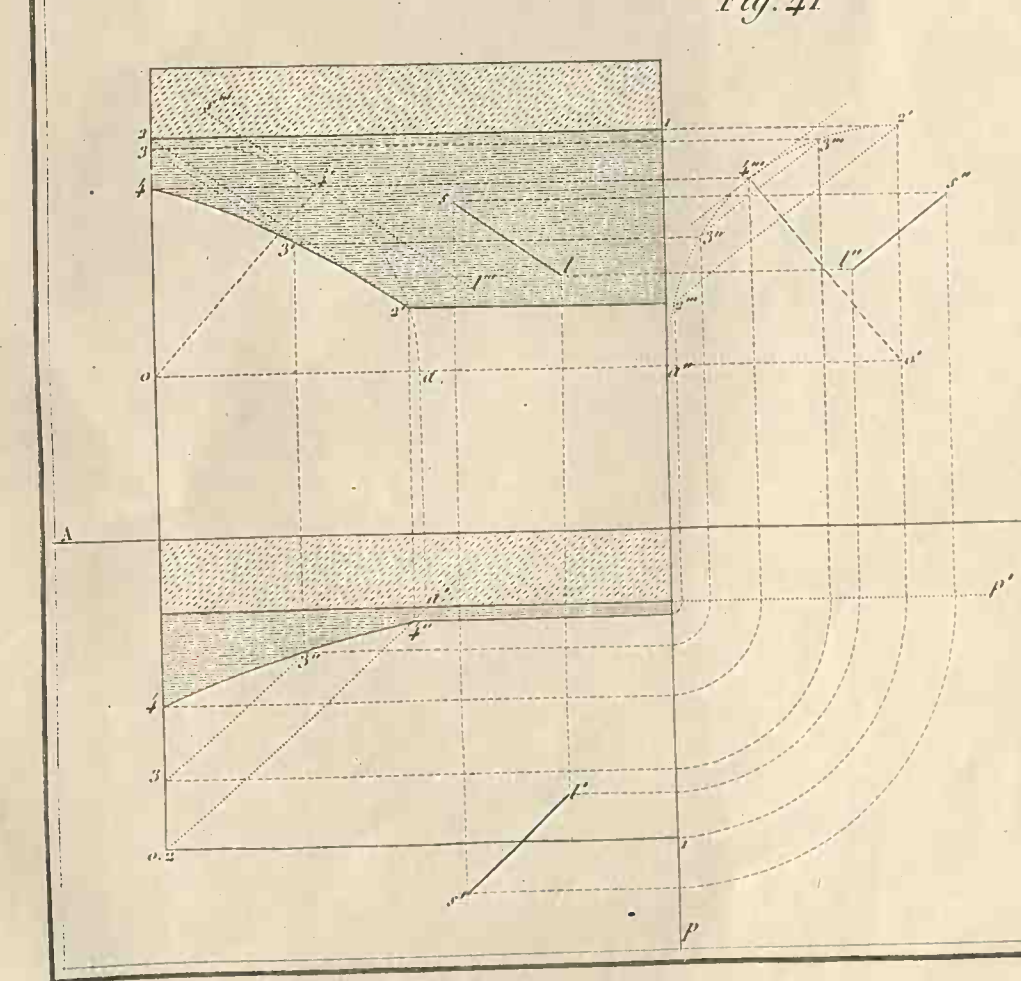

Fig. 41

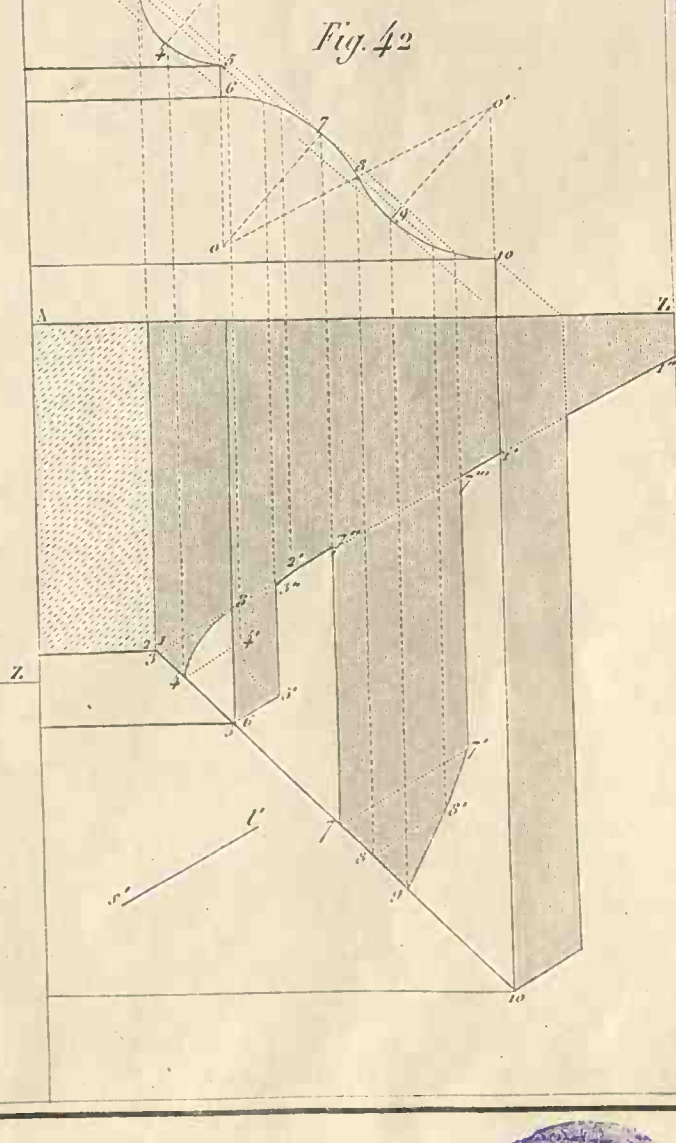

Fig. 42



Fig. 43

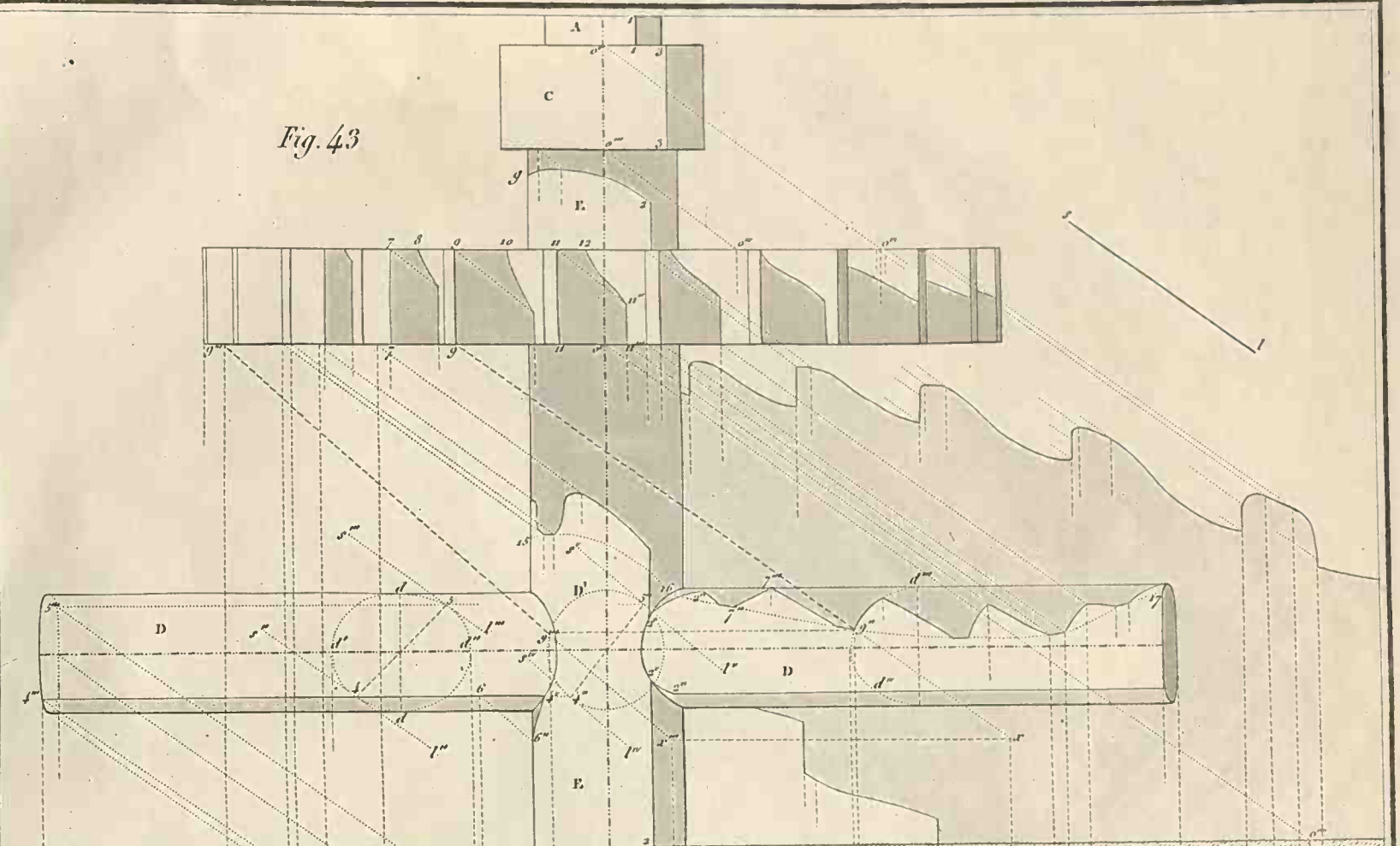
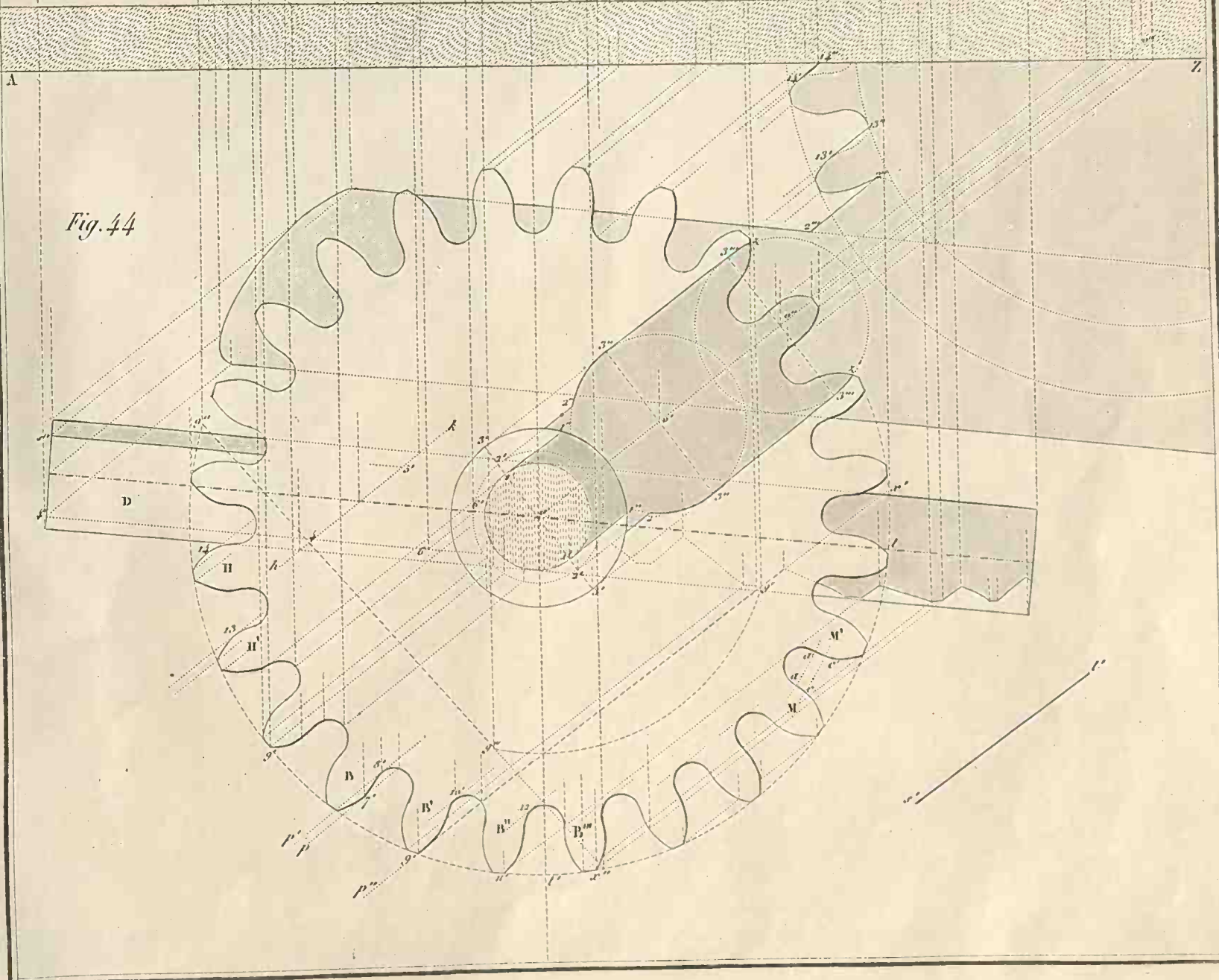
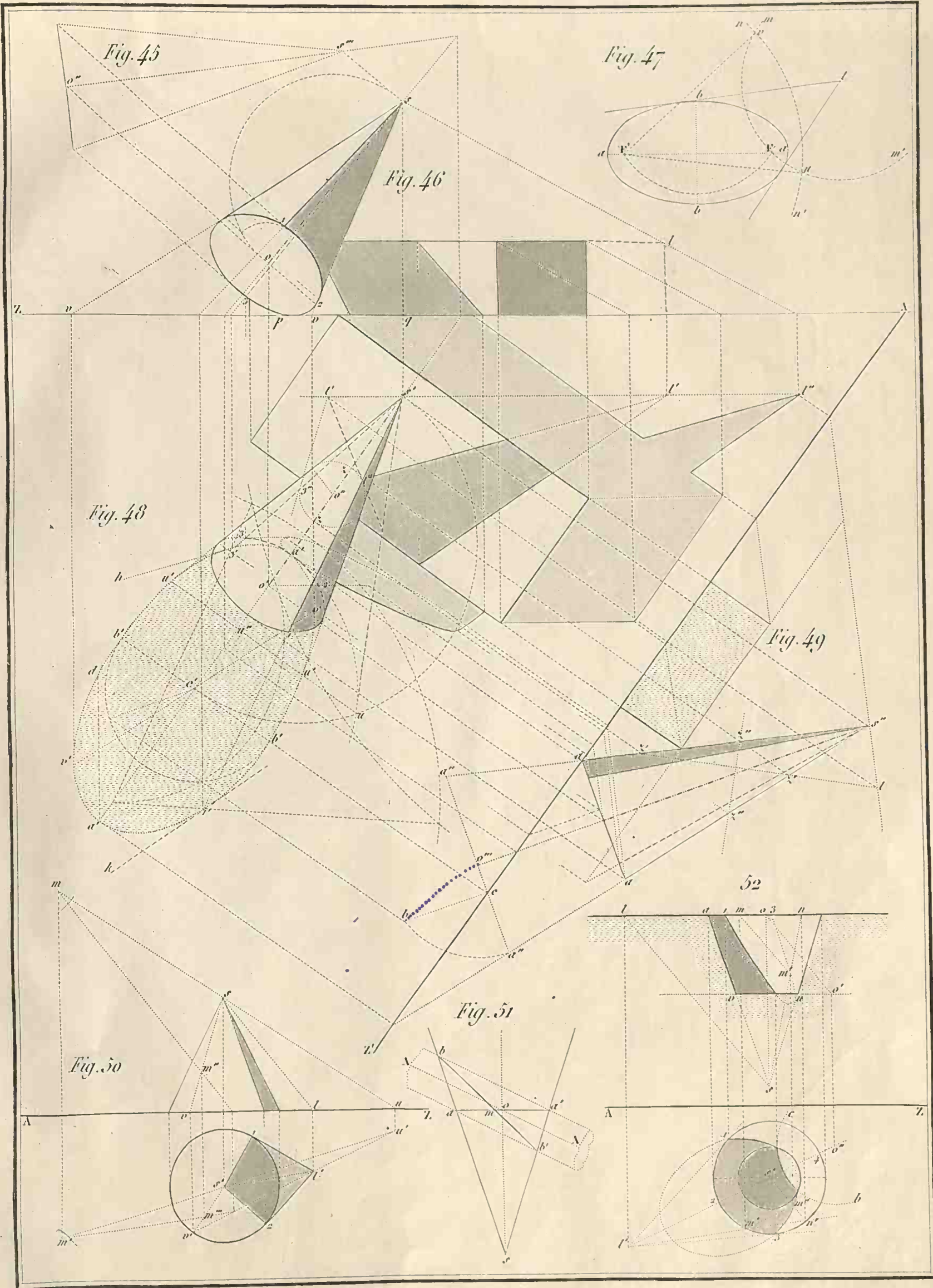

Fig. 44





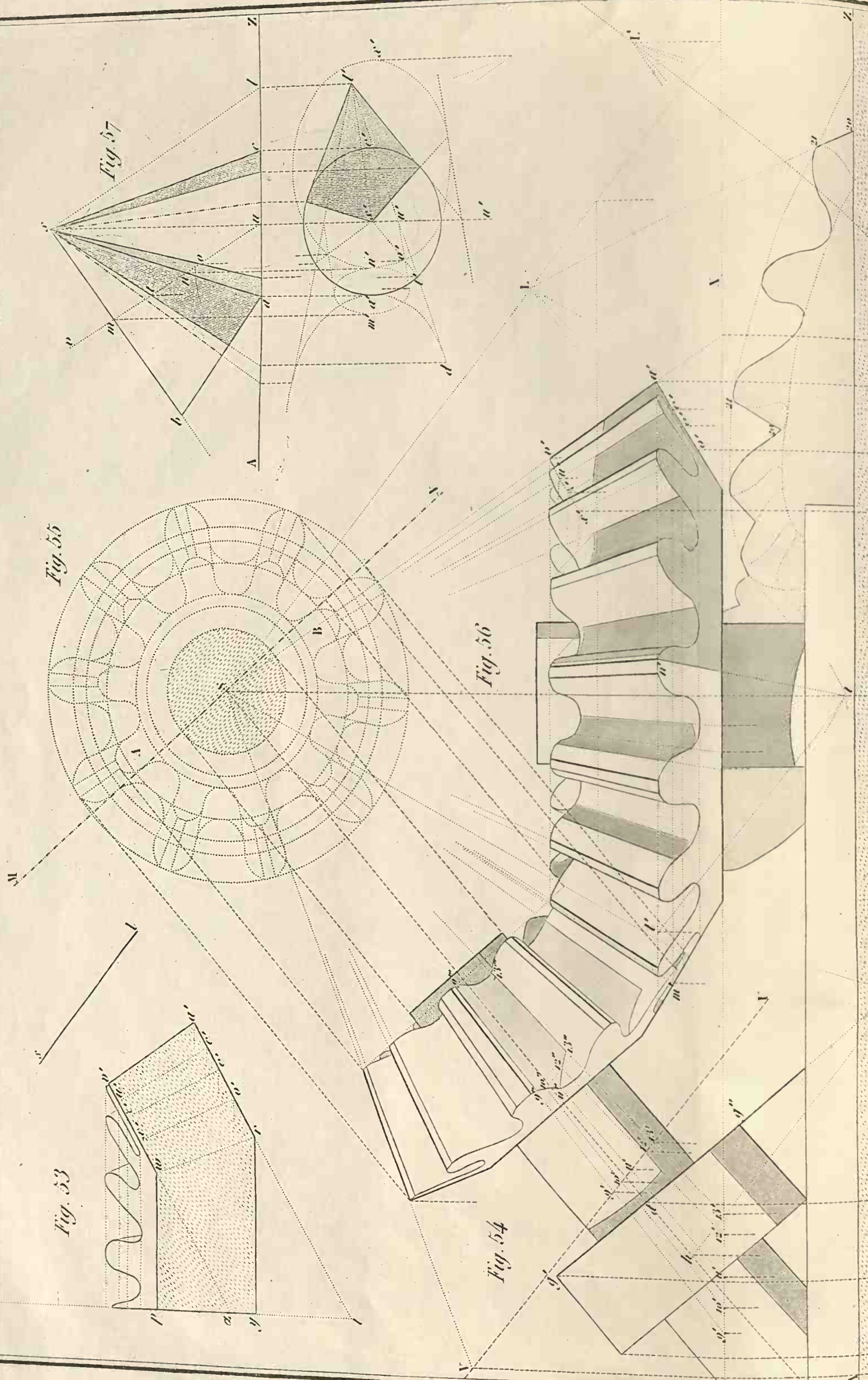

Fig. 53

Fig. 55

Fig. 54

Fig. 56

Fig. 57

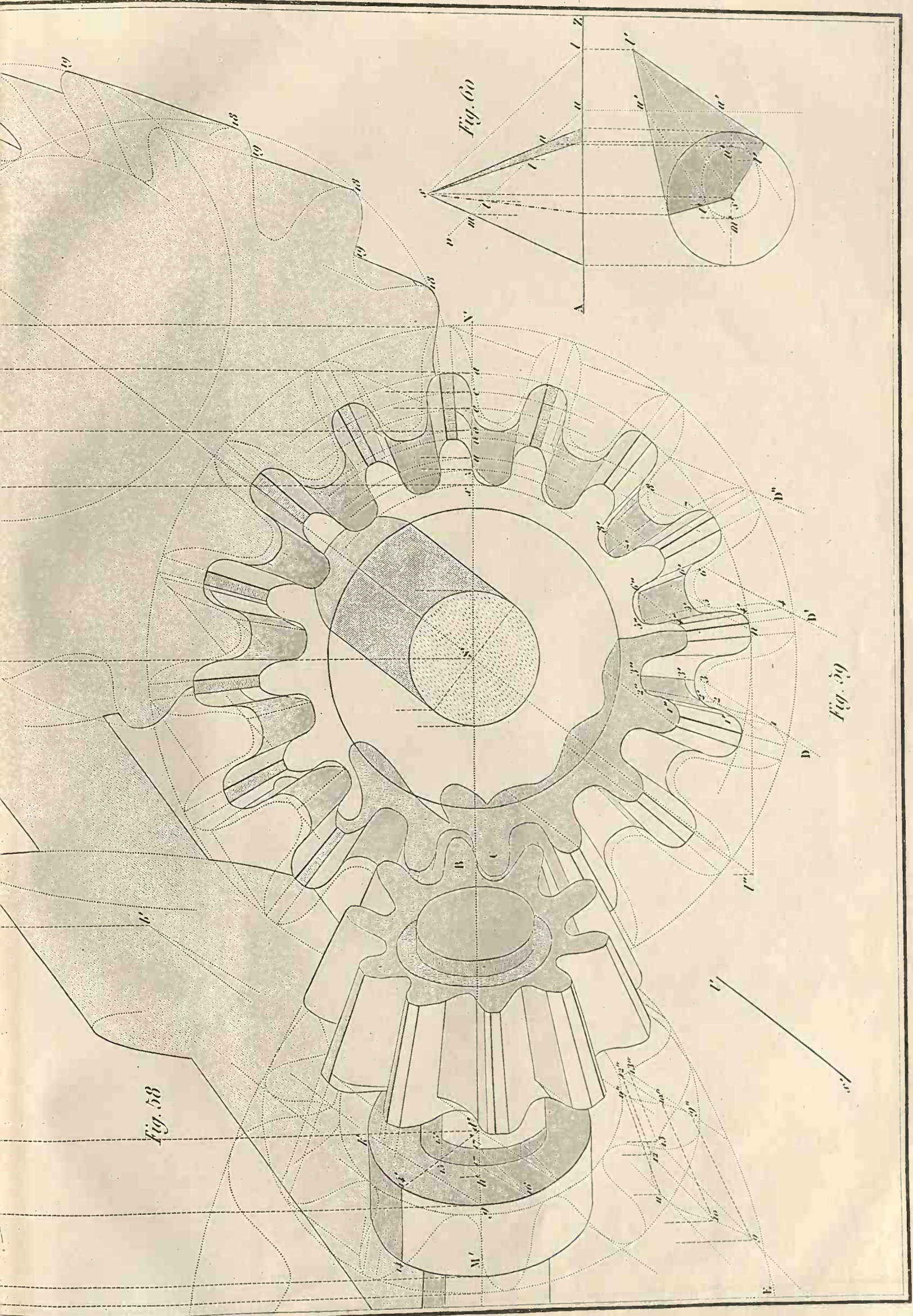

Fig. 58

Fig. 60

Fig. 59

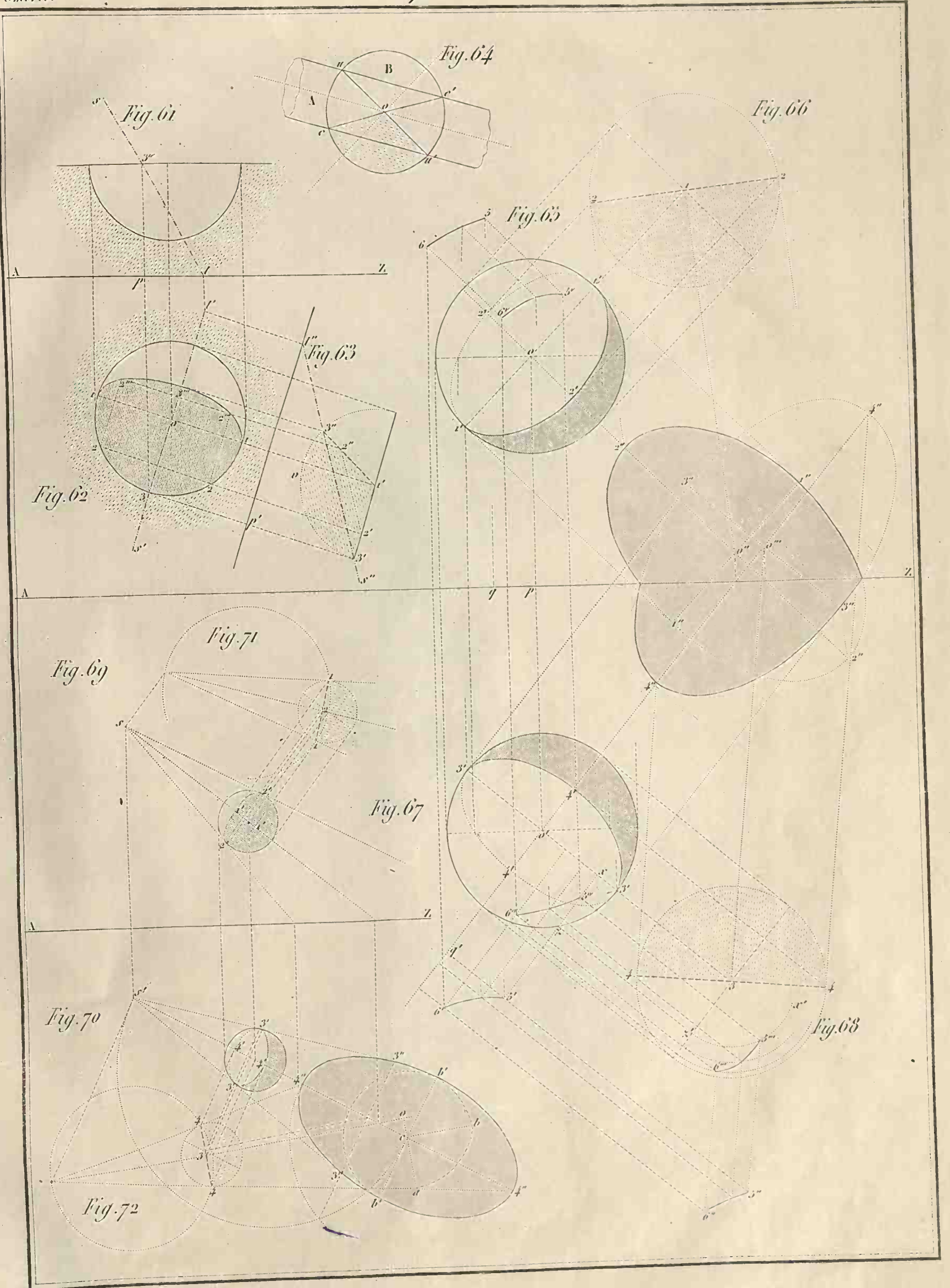

Fig. 73

Fig. 75

Fig. 74

Fig. 76

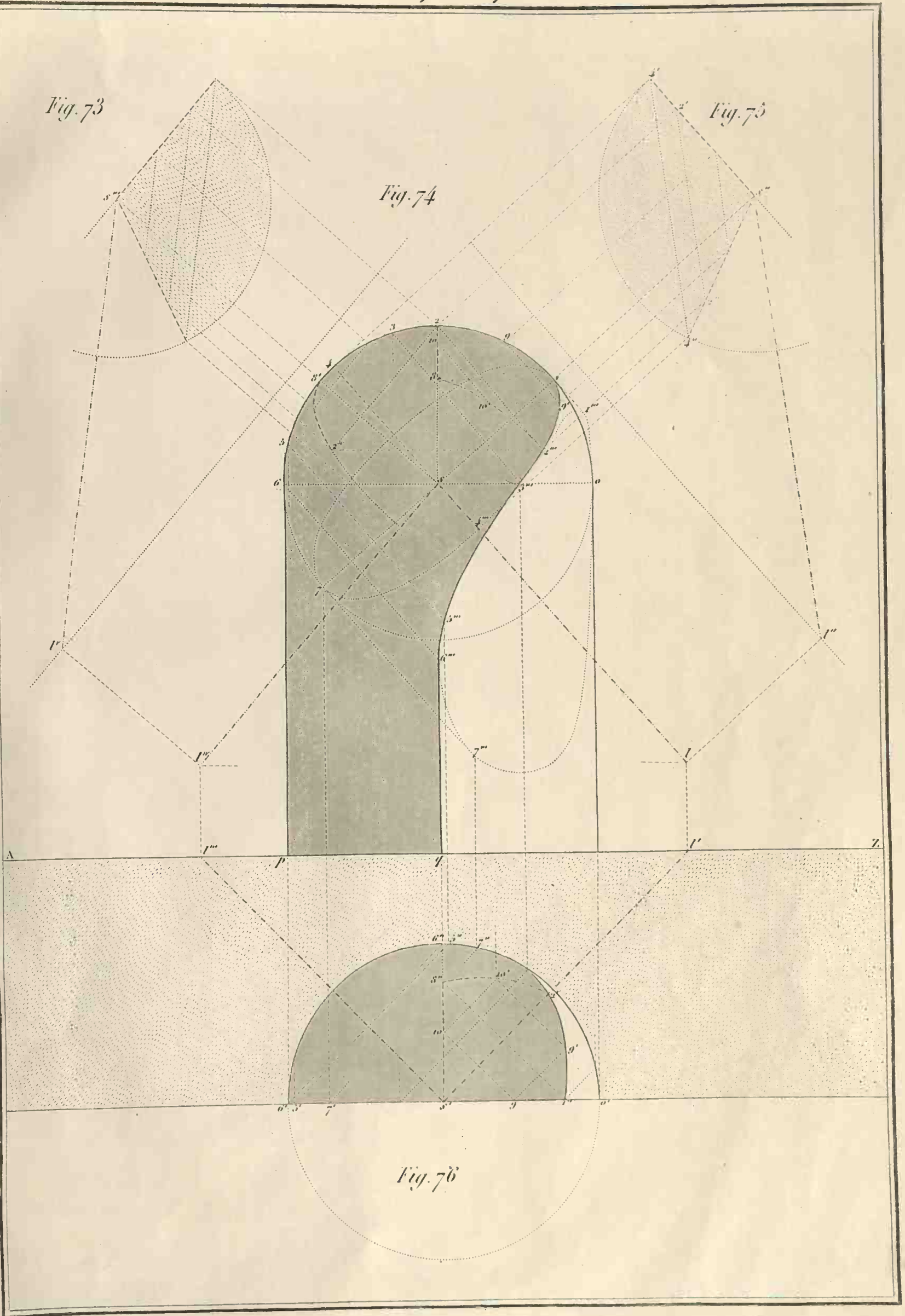

Fig. 12.

Fig. 1.

Fig. 13.

Fig. 14.

Fig. 15.

Fig. 2.

Fig. 3.

Fig. 5.

Fig. 6.

Fig. n.

Fig. 4.

Fig. 7.

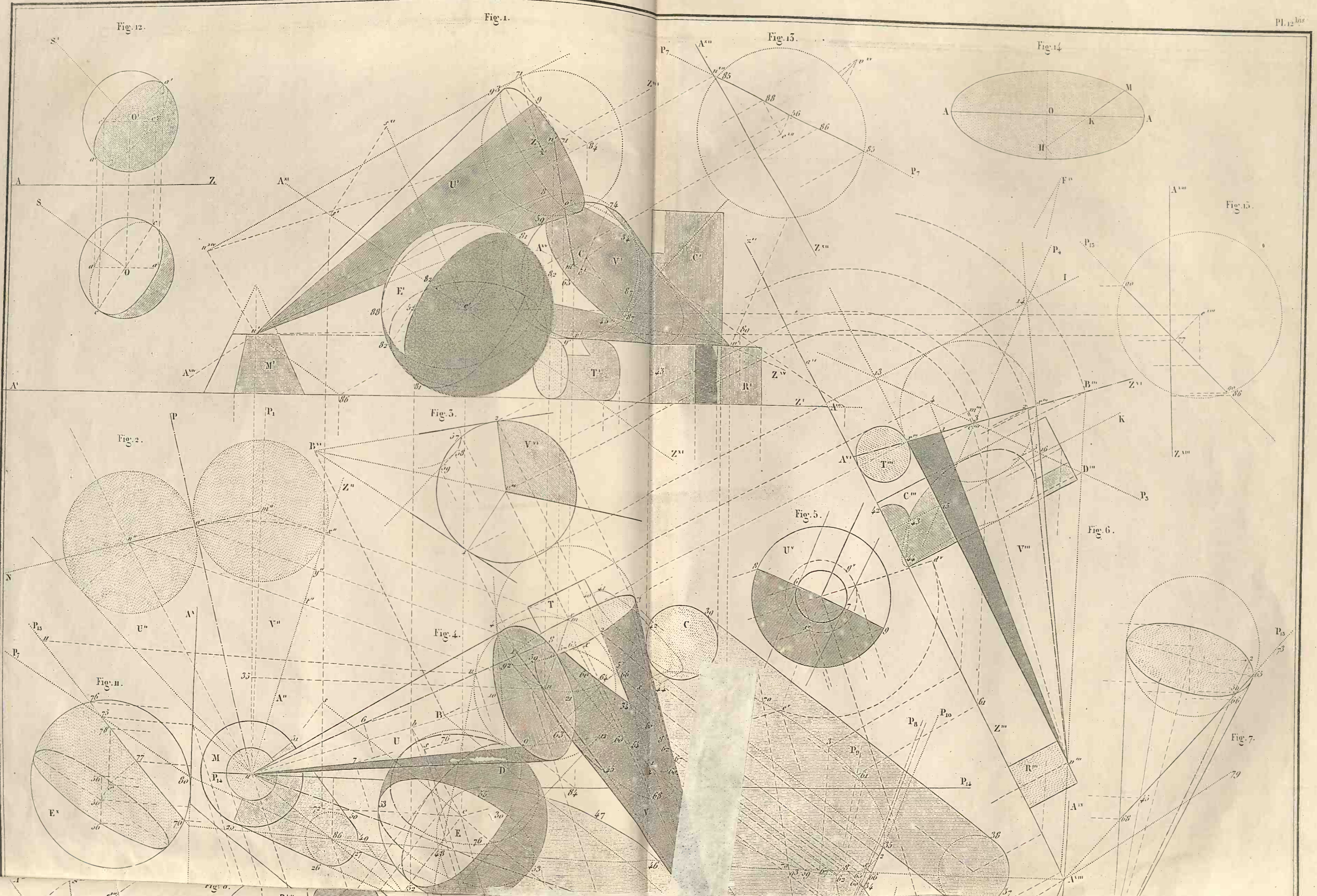

Fig. 6

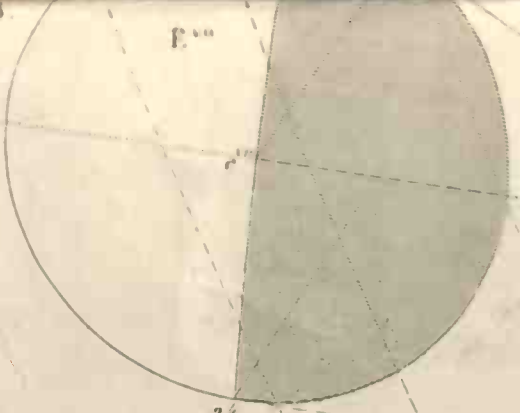

Fig. 16

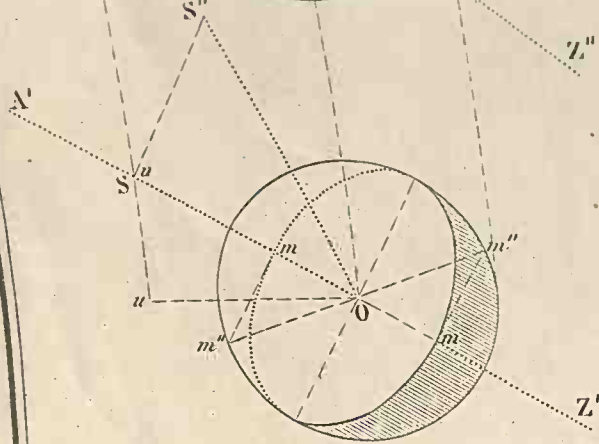

Fig. 17

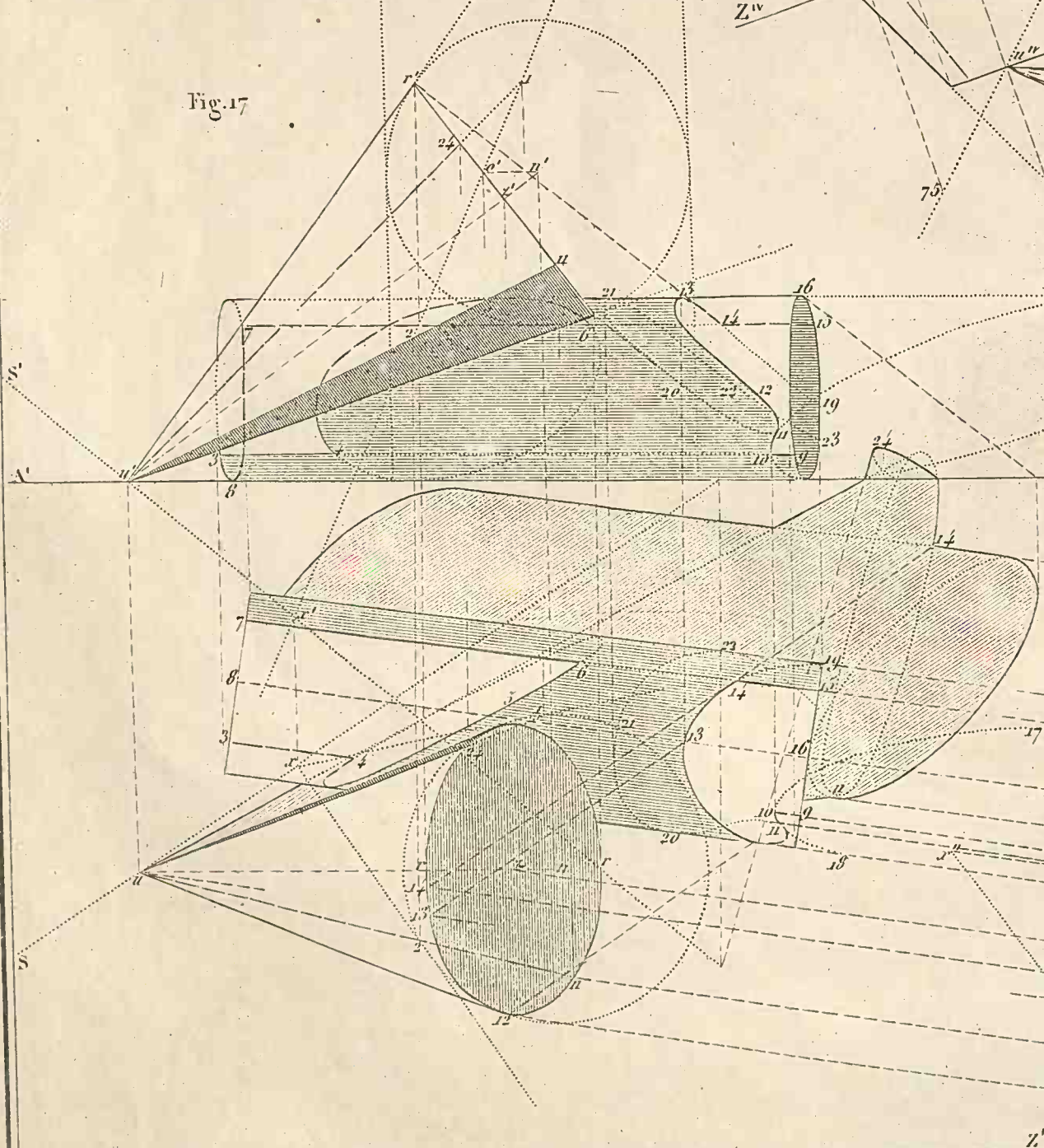

Fig. 10

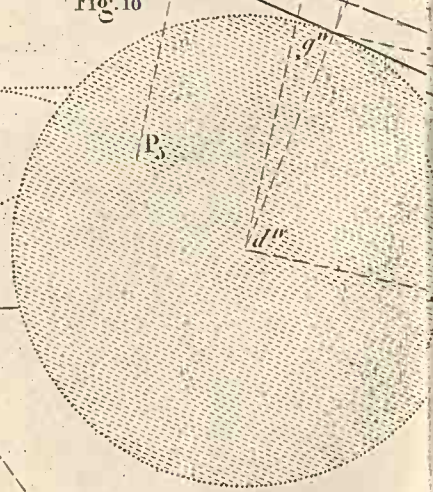

Fig. 18

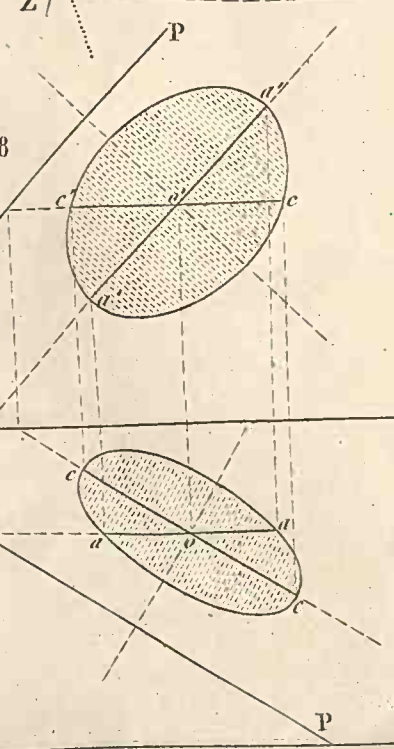

Fig. 20

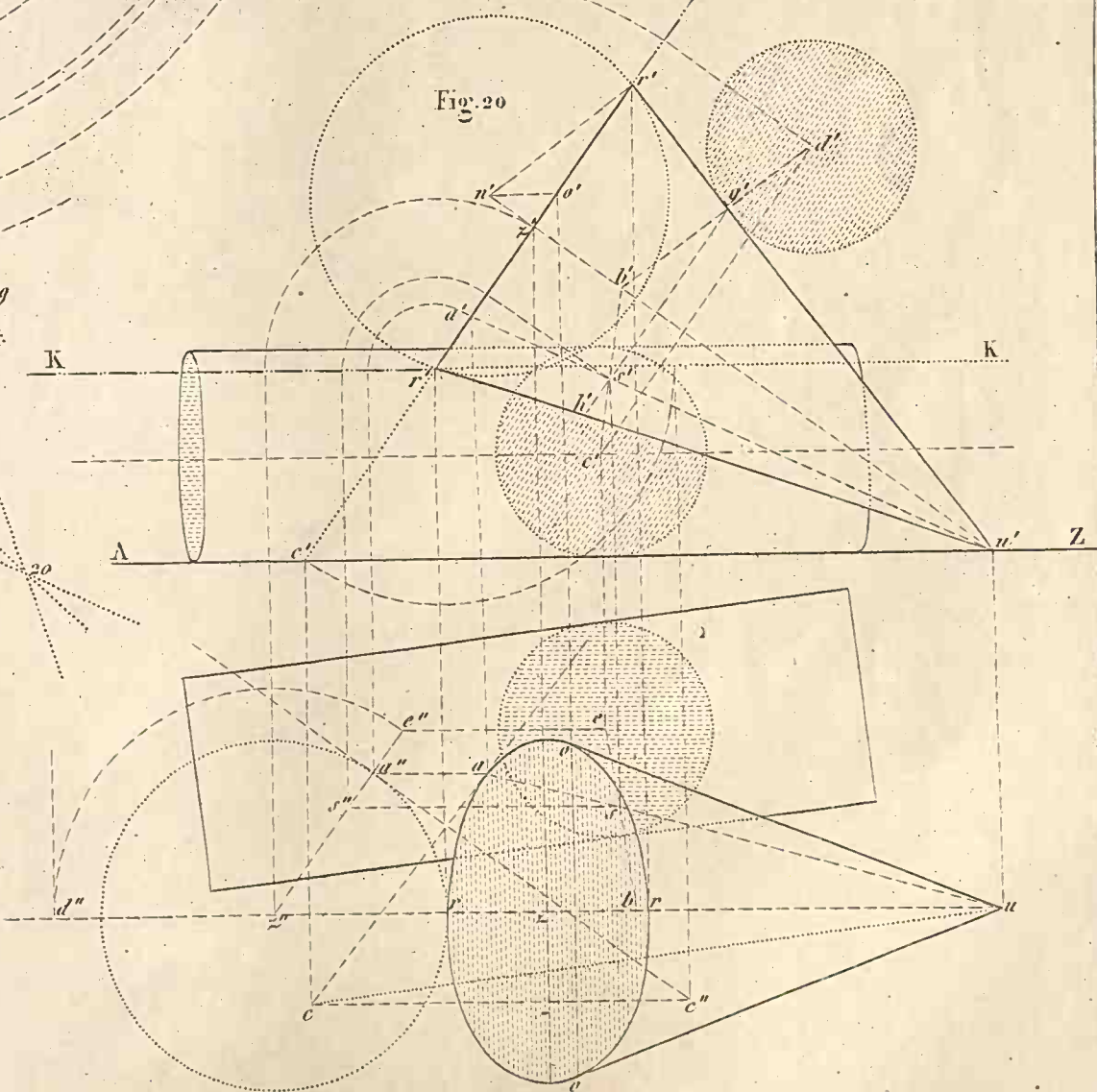

Fig. 19

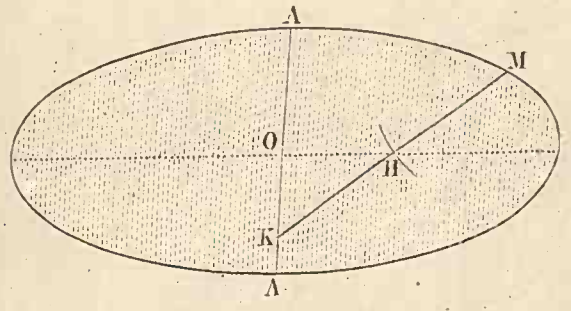

Fig. 77.

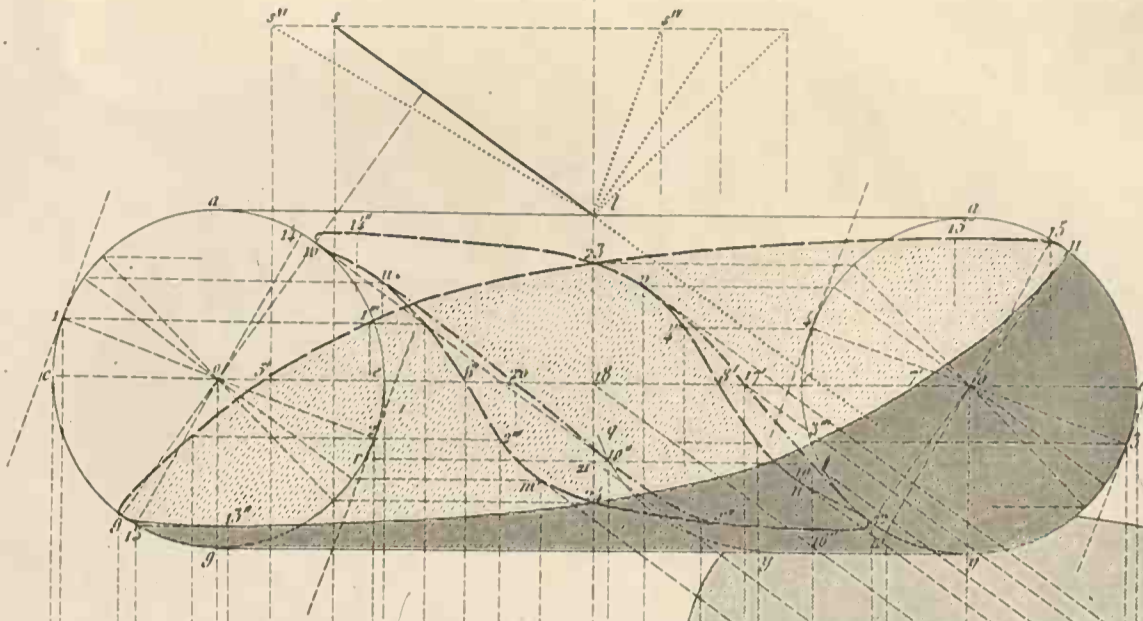
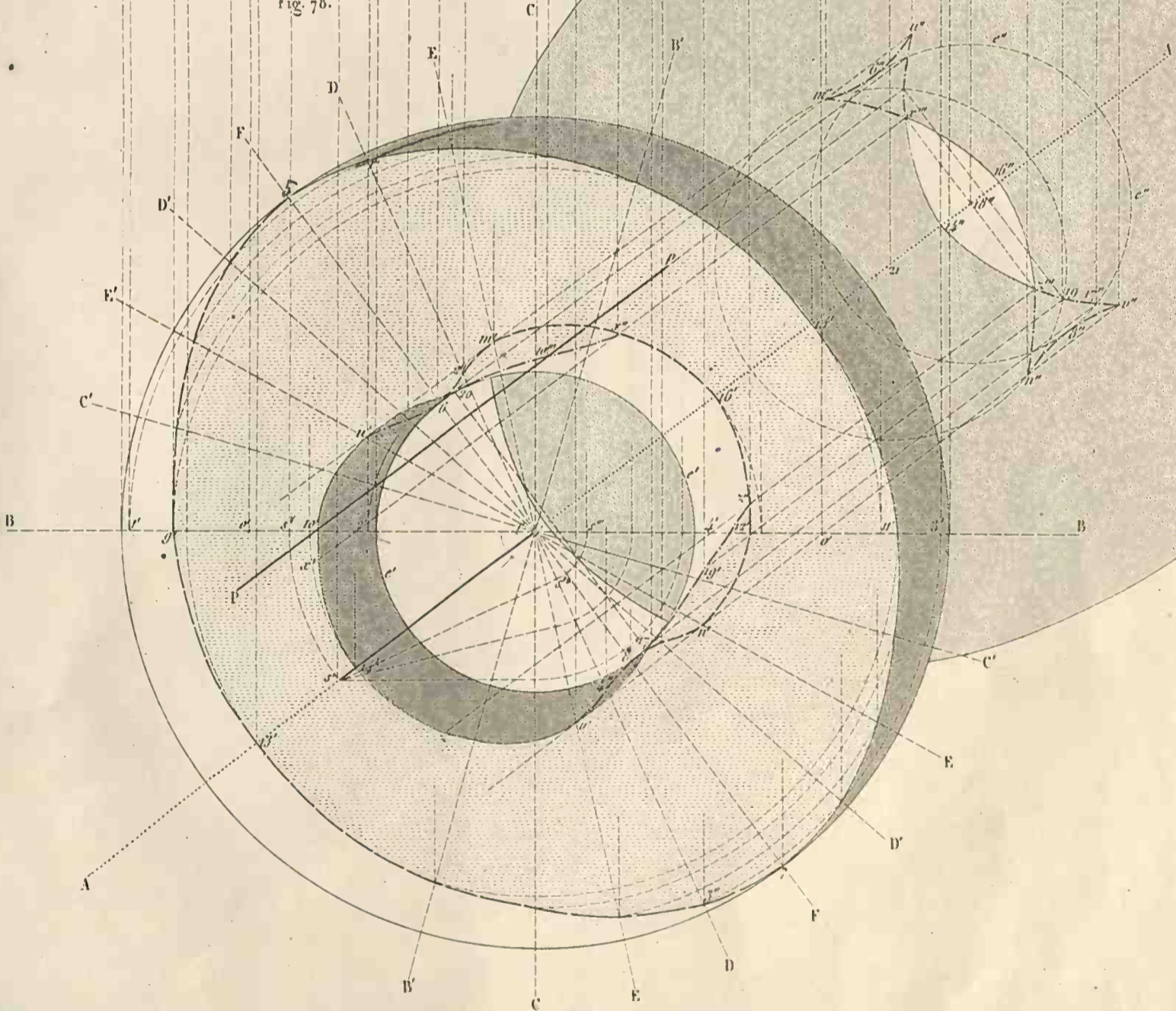
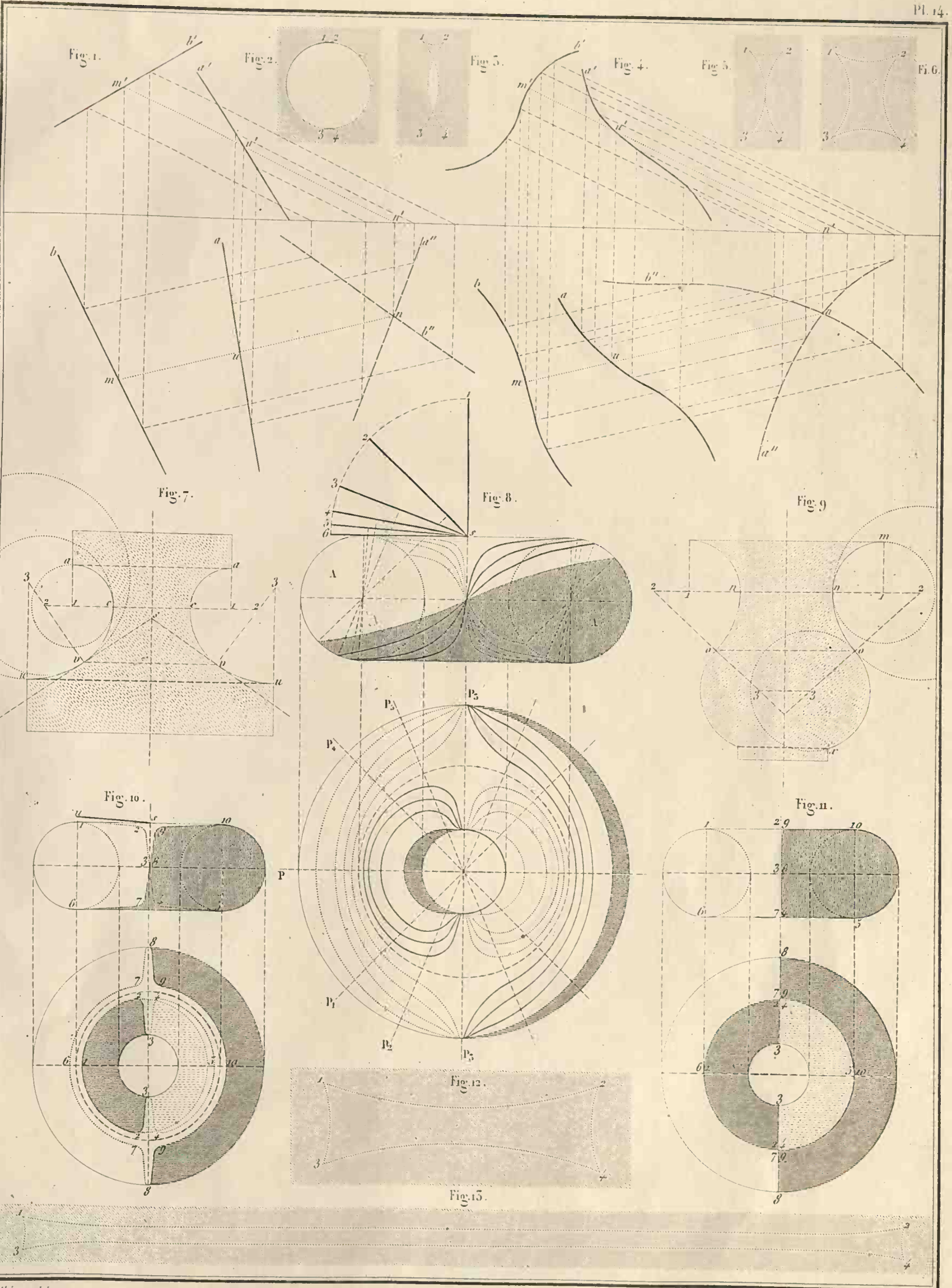

Fig. 78.





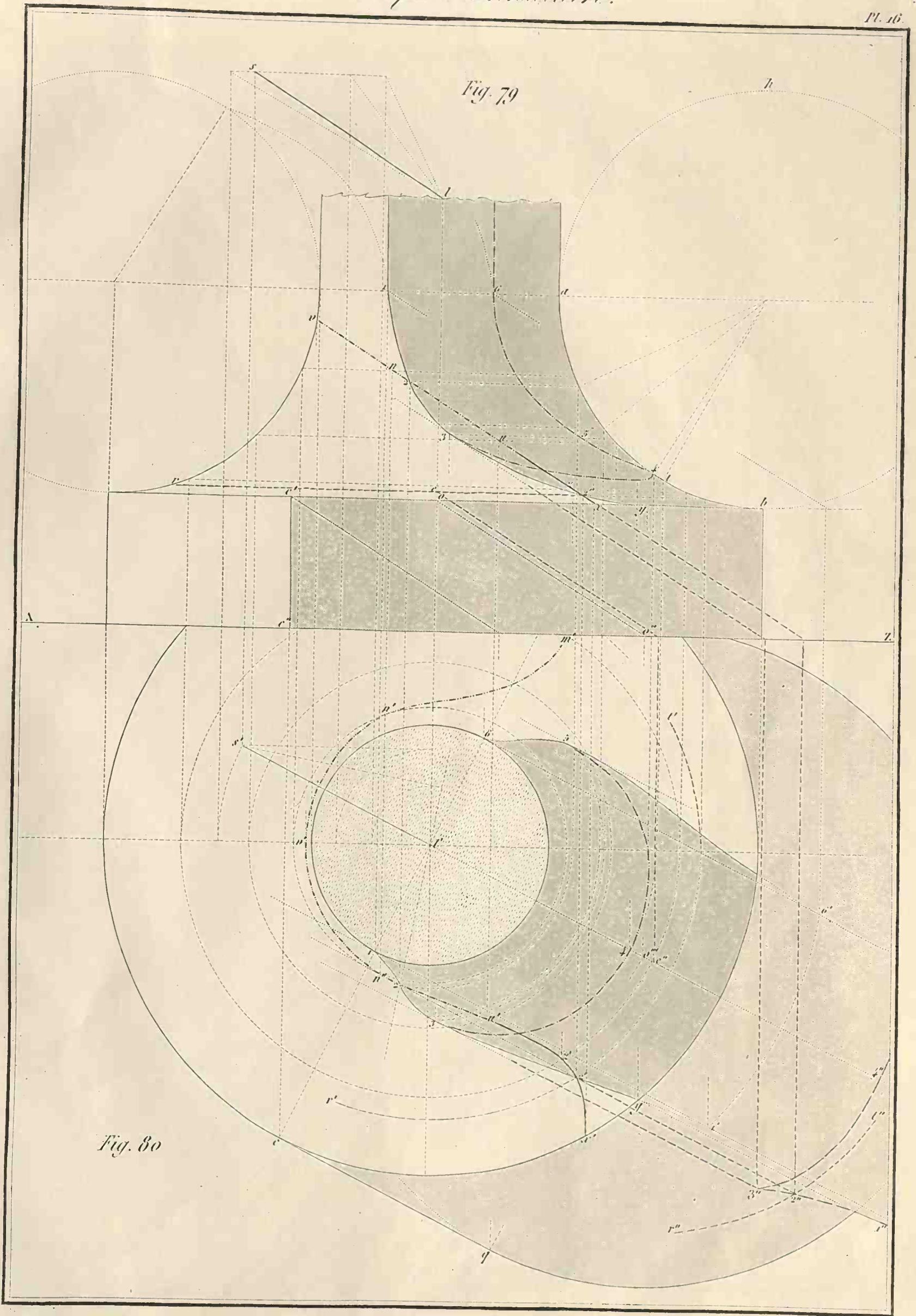

Fig. 81

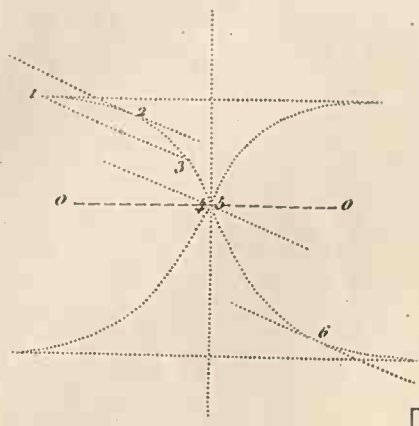

Fig. 82

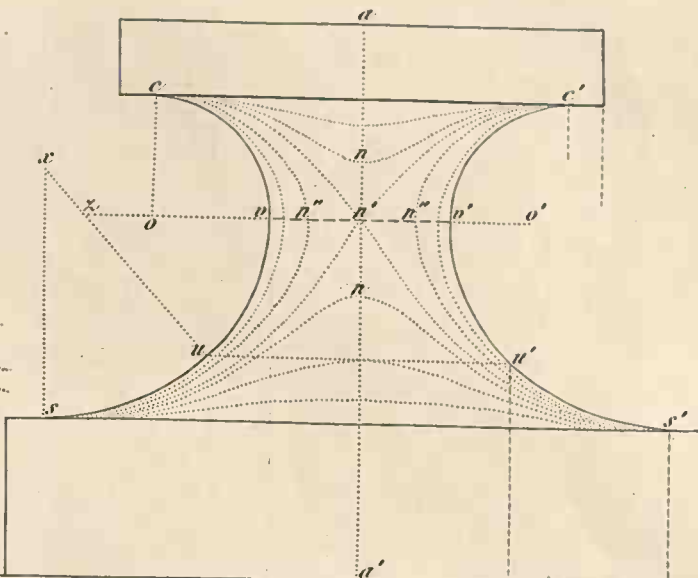

Fig. 83

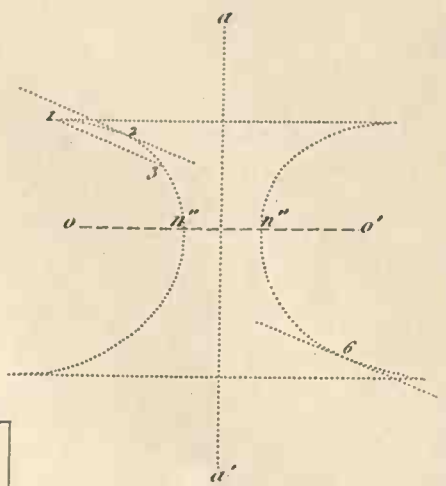

Fig. 84

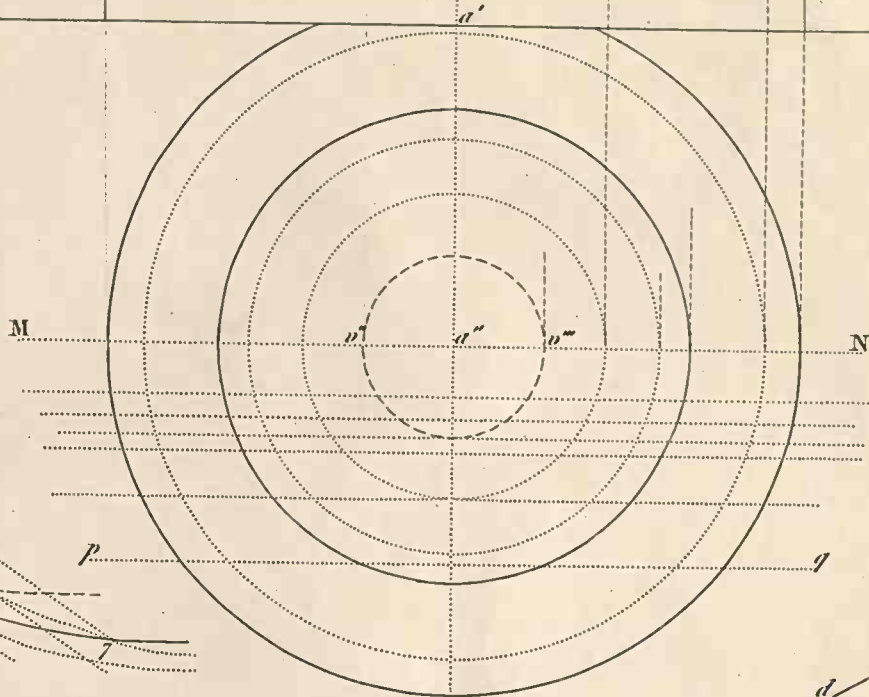
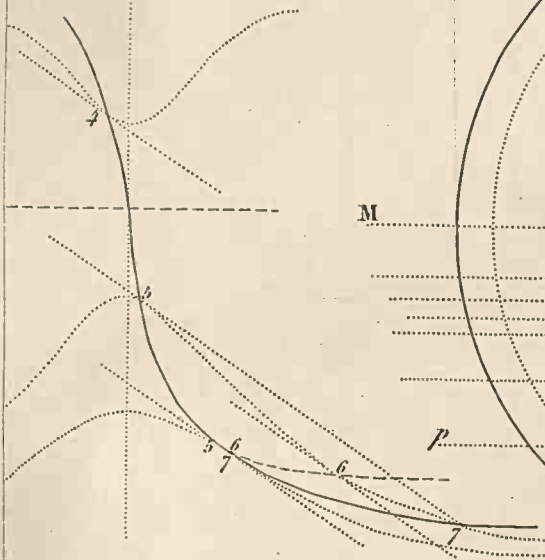

Fig. 85

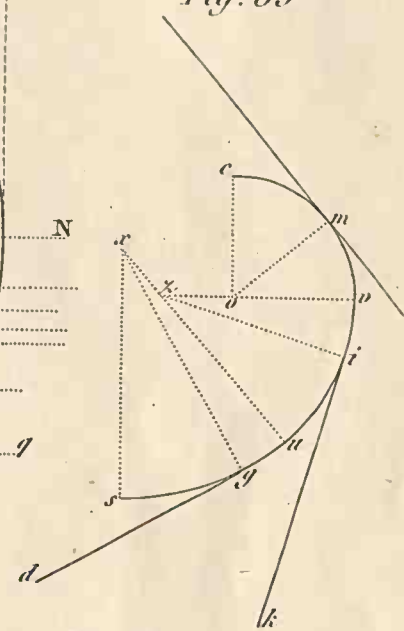

Fig. 86

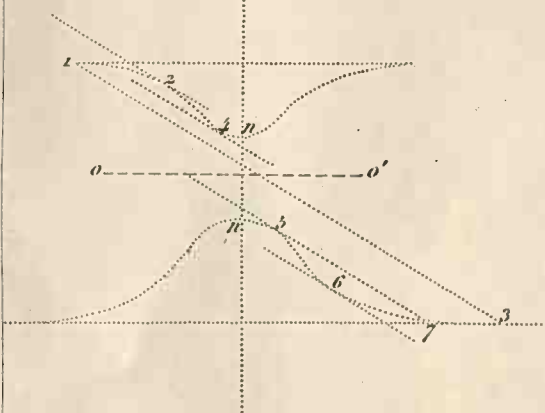

Fig. 87

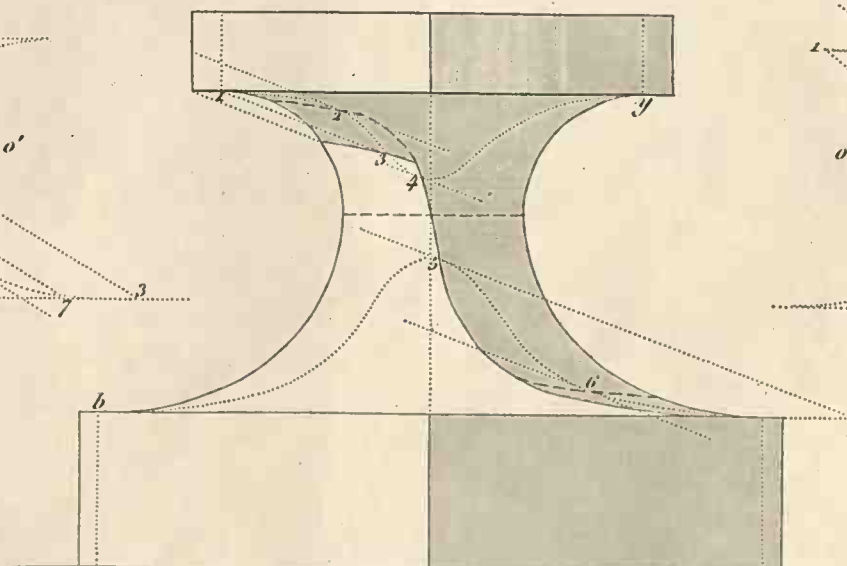

Fig. 88

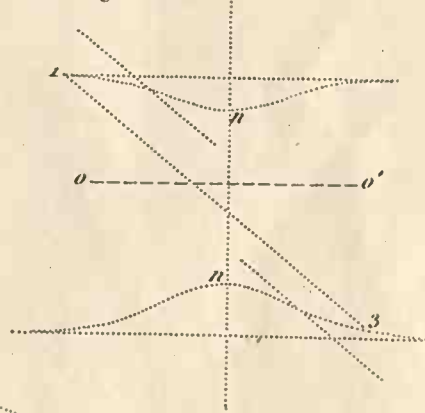

Fig. 89

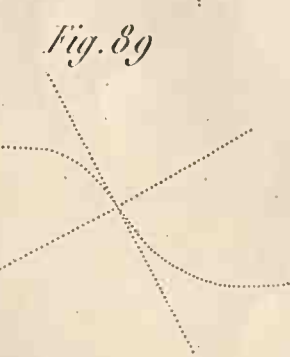
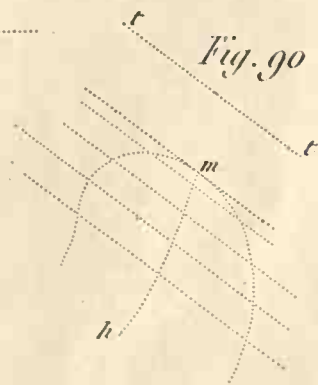
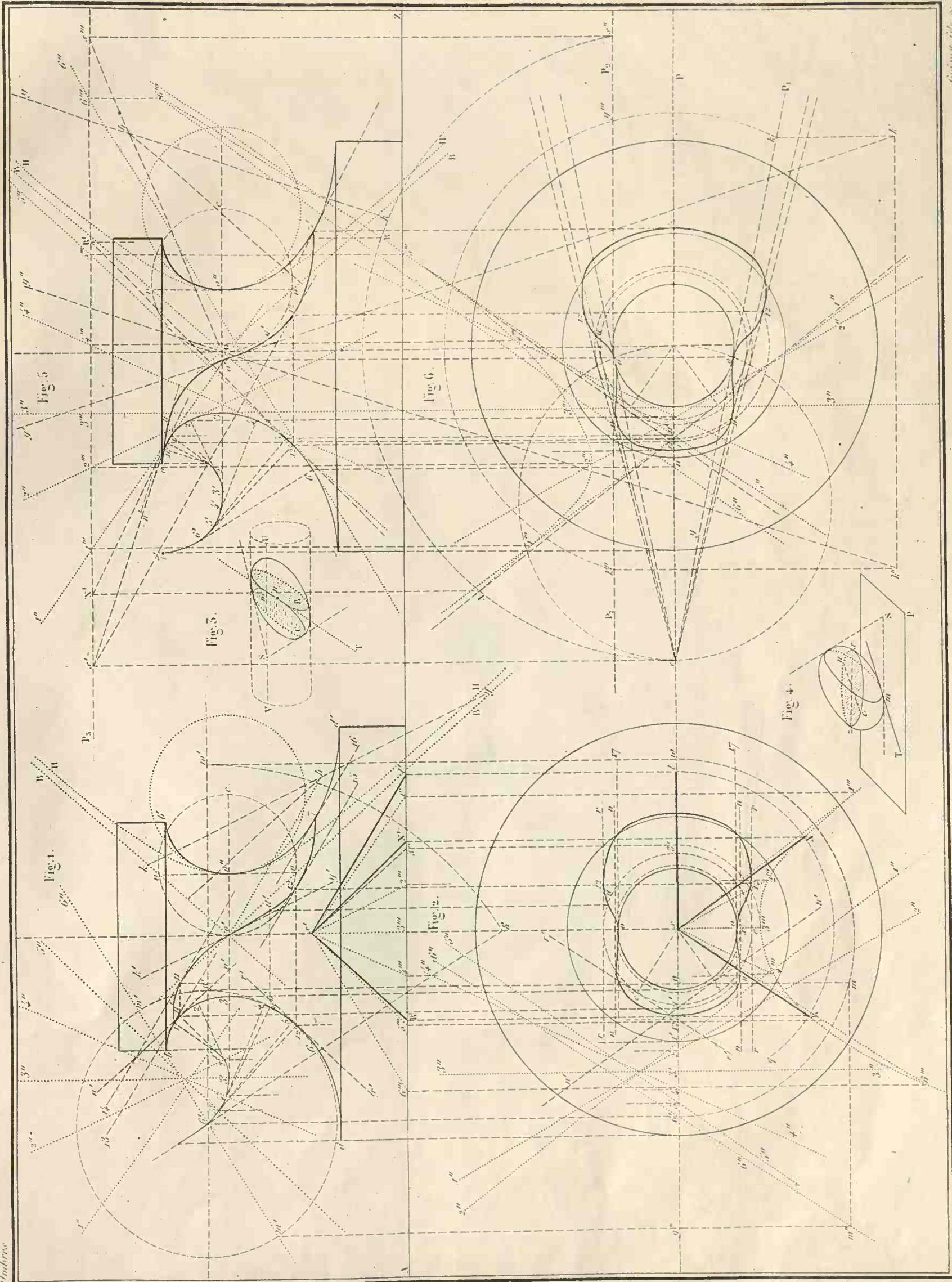

Fig. 90



24559.

SCOTTIE



Umbrae

Alchimar del

Quadrat. Tab. 18.

Fig. 91

Fig. 93

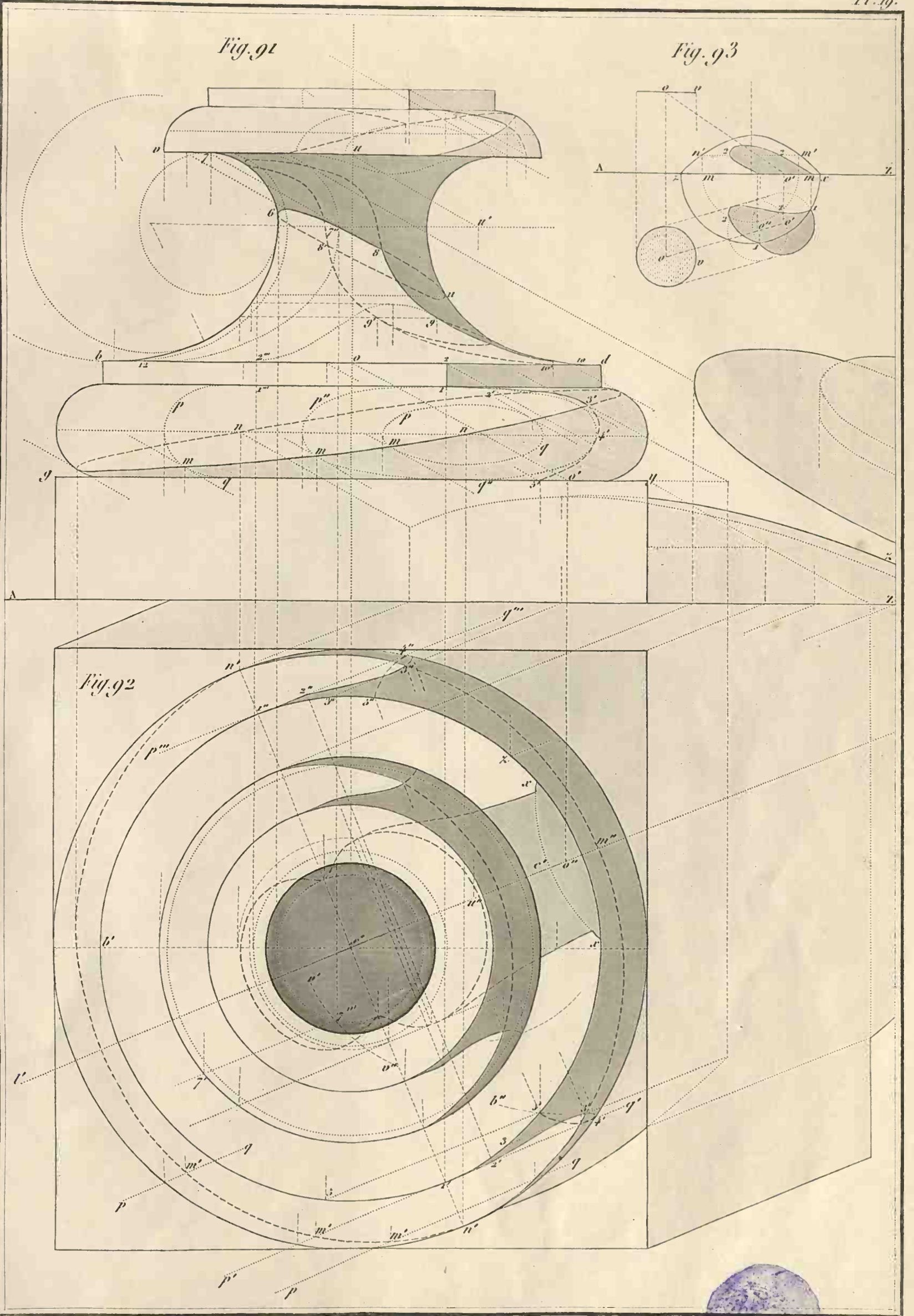

Fig. 94

Fig. 96

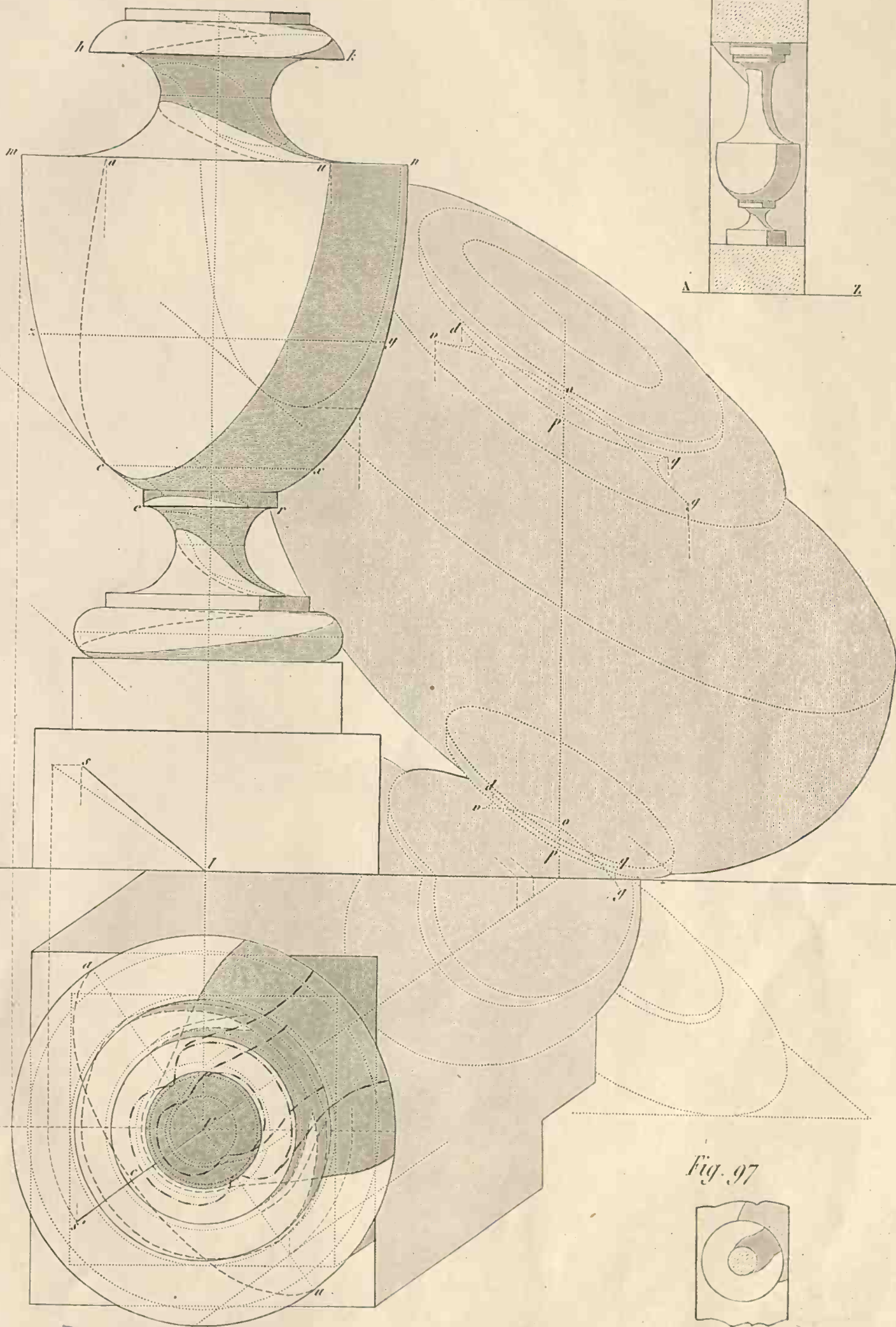

Fig. 95

Fig. 97

Fig. 98

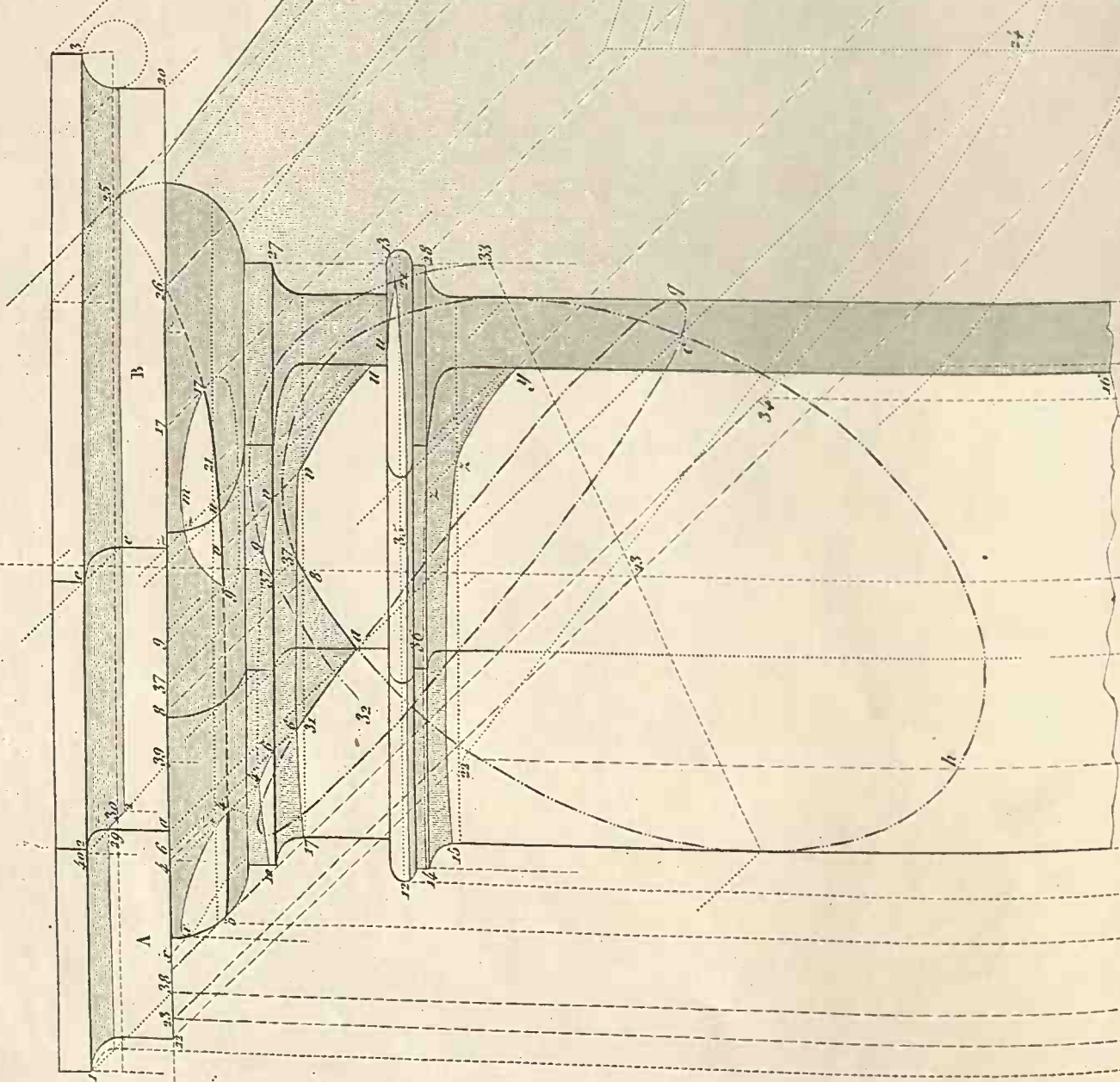

Fig. 100

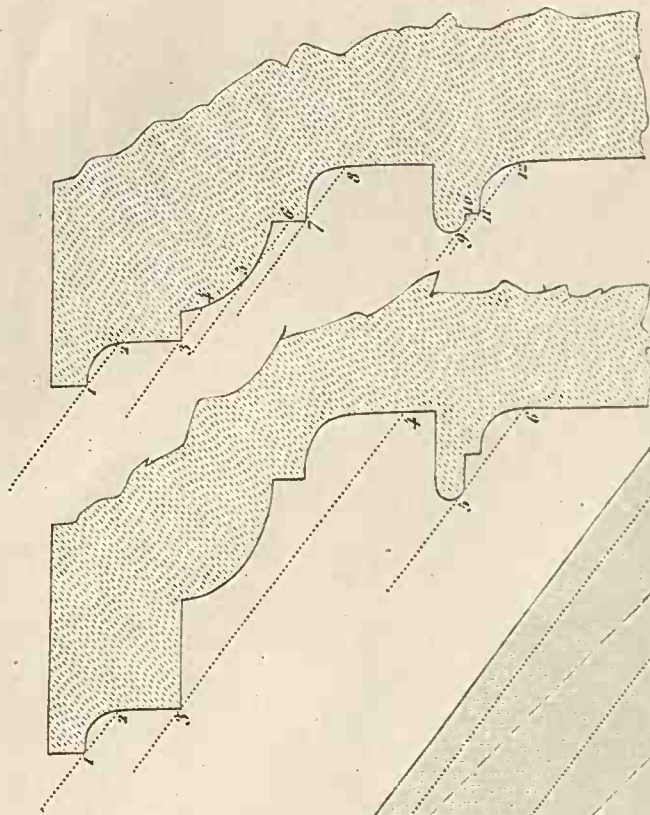

Fig. 101

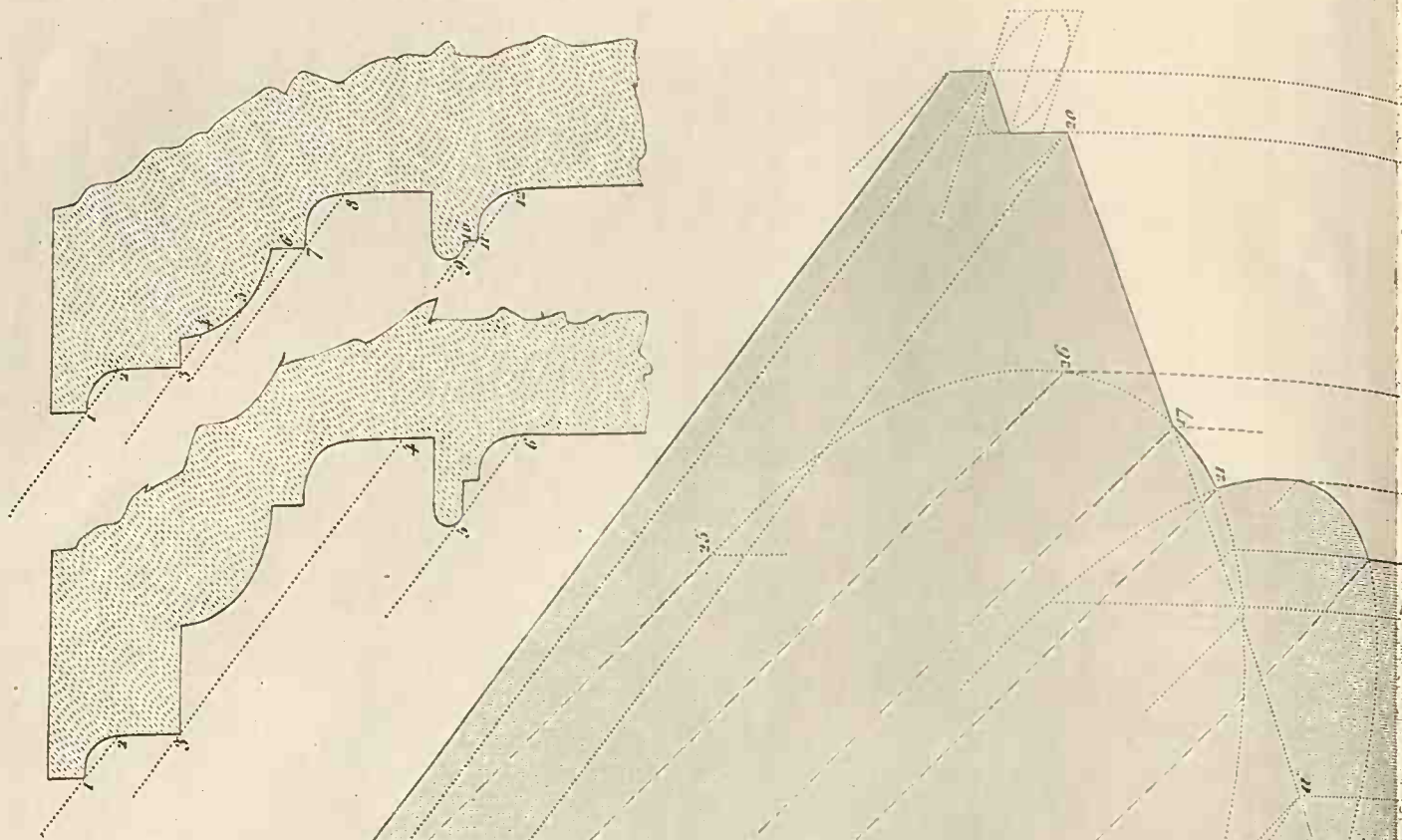

Fig. 102

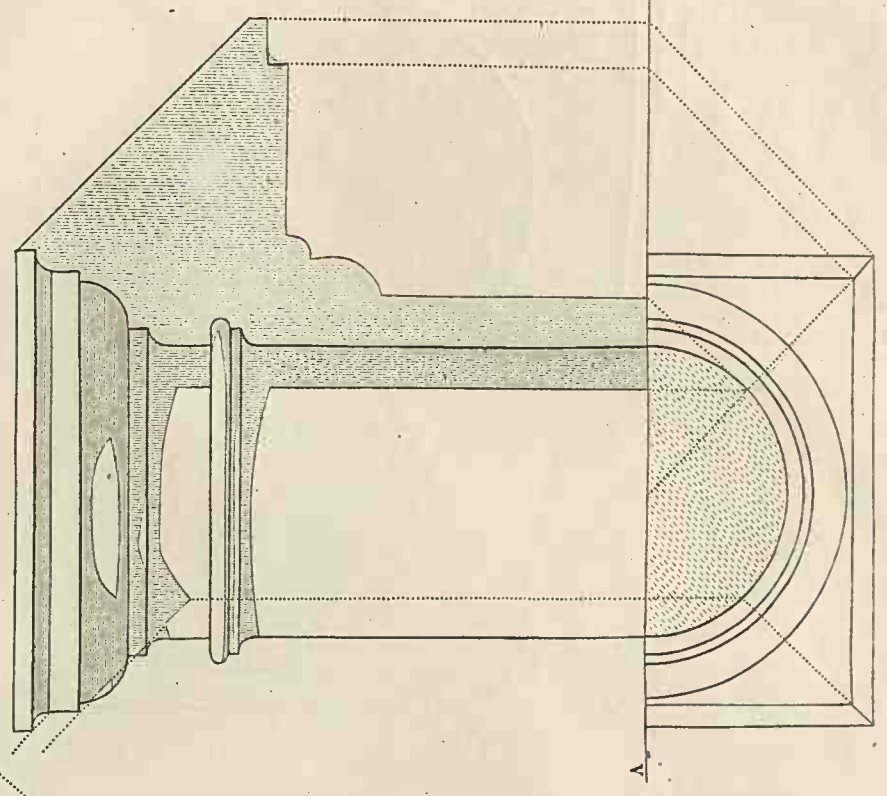
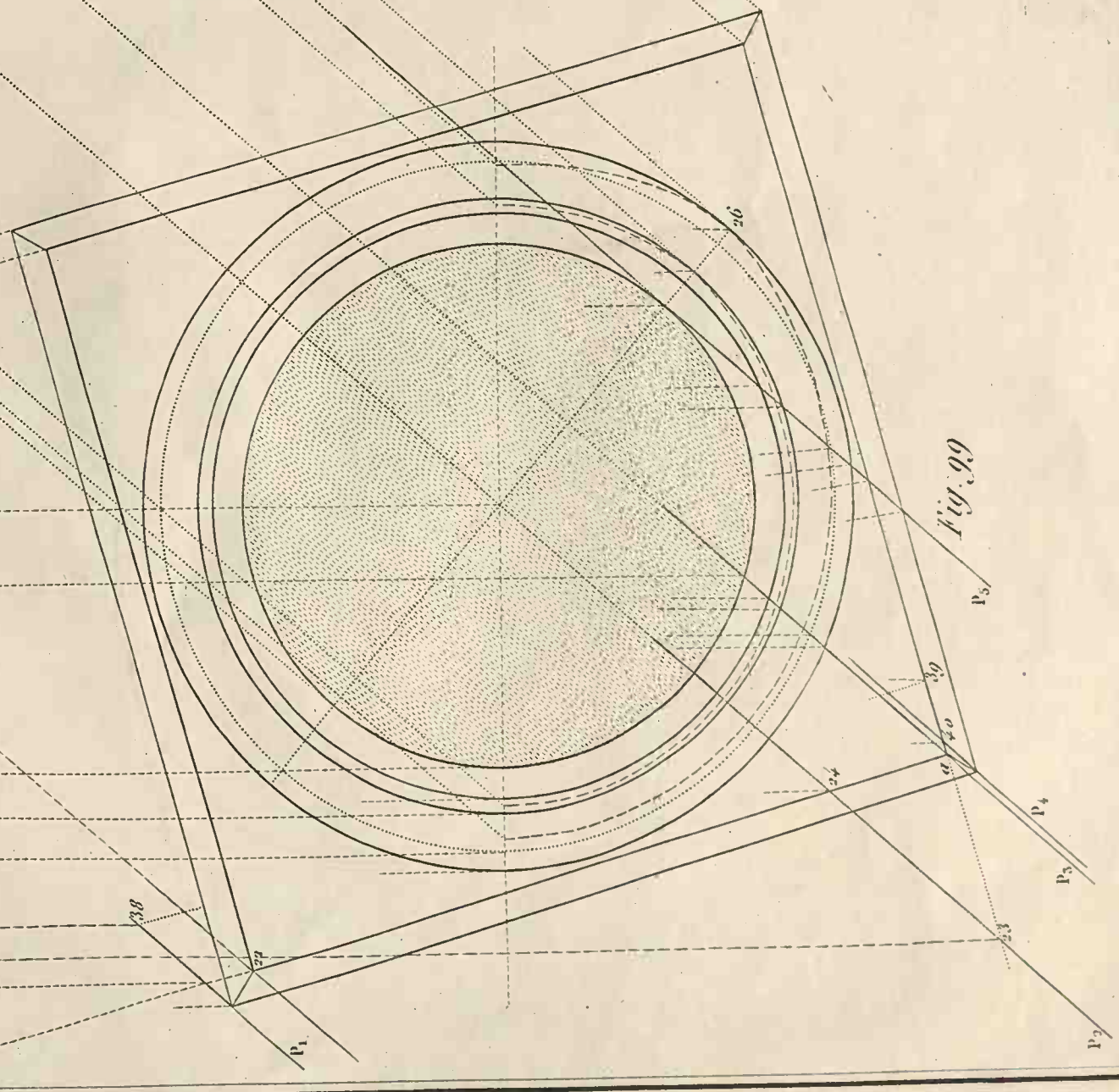
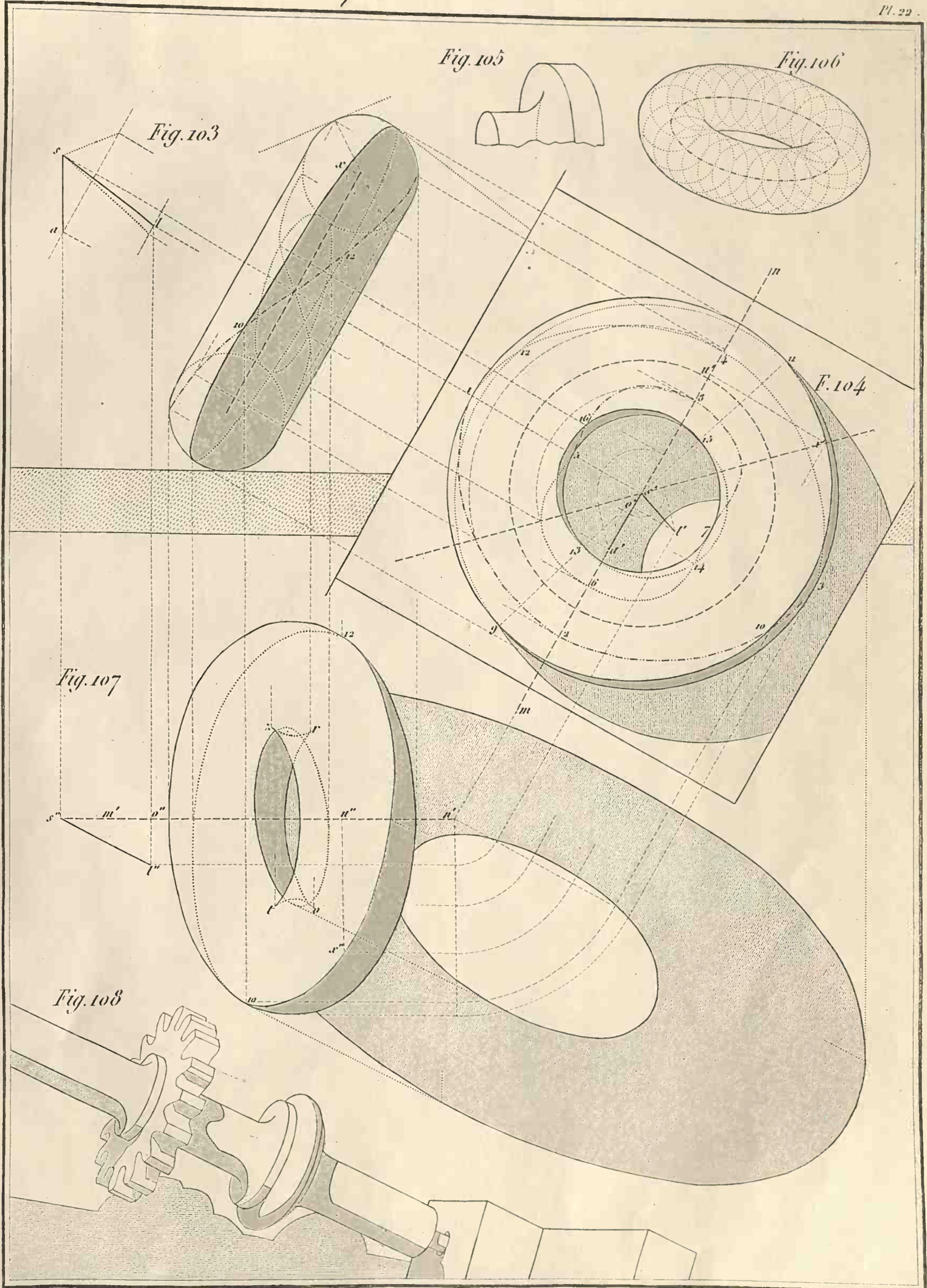

Fig. 99





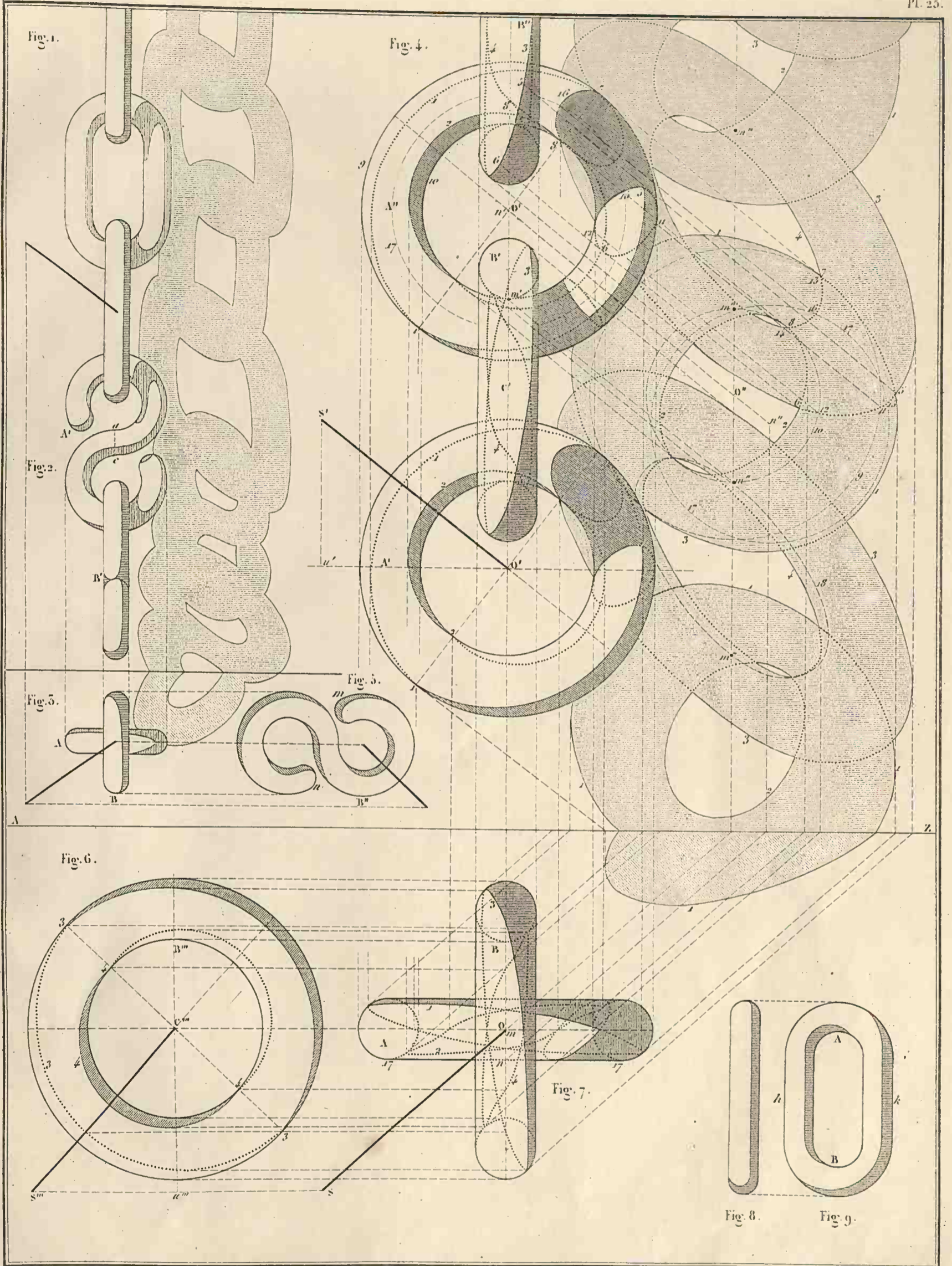

Fig. 1

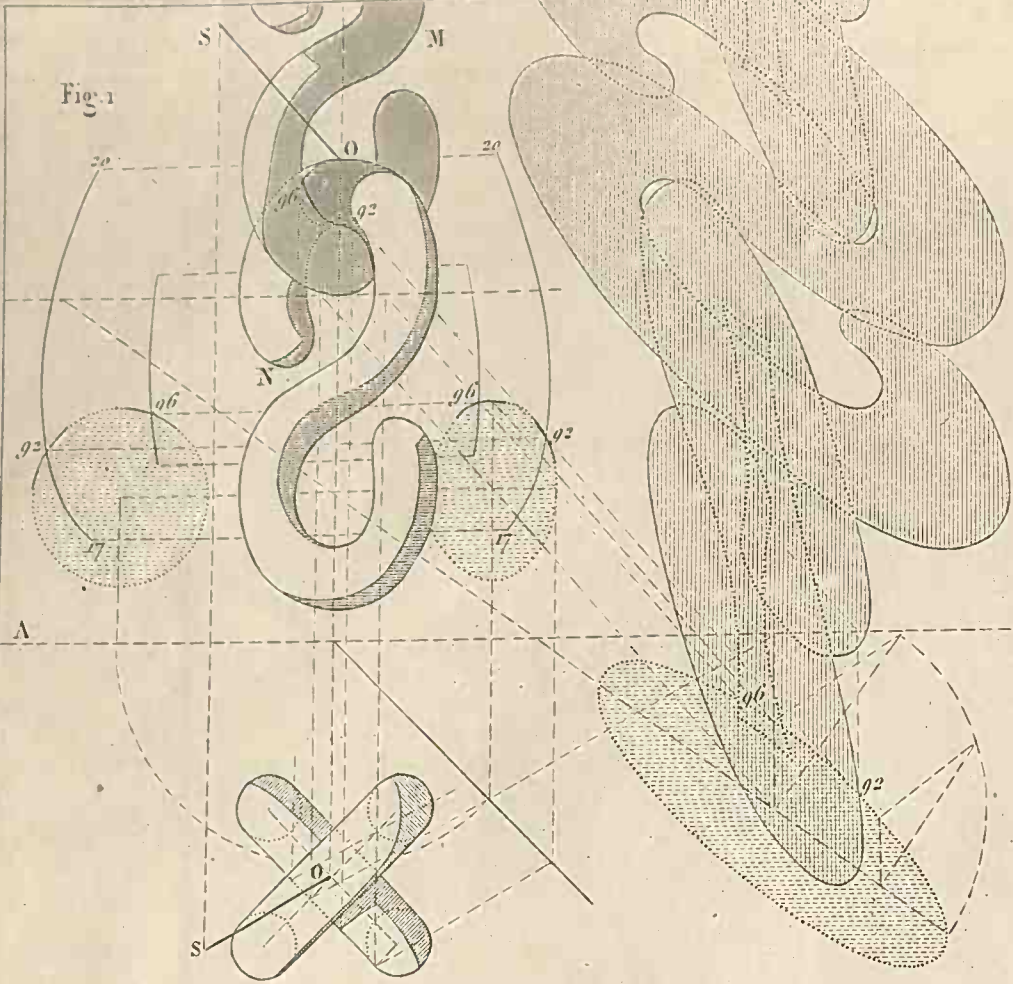

Fig. 11

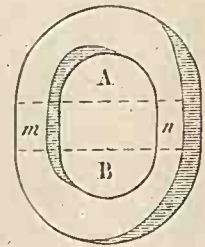

Fig. 3

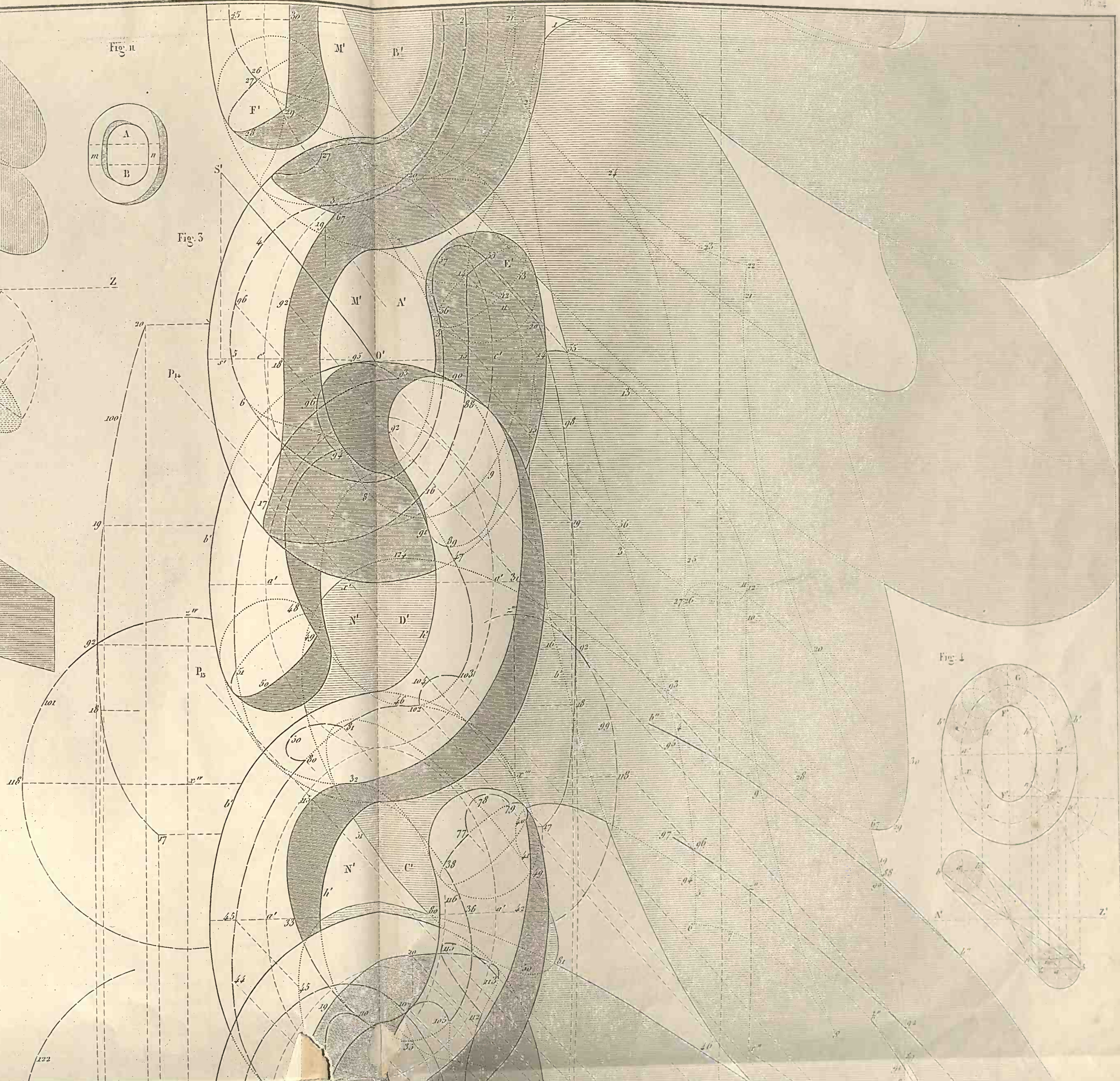

Fig. 2

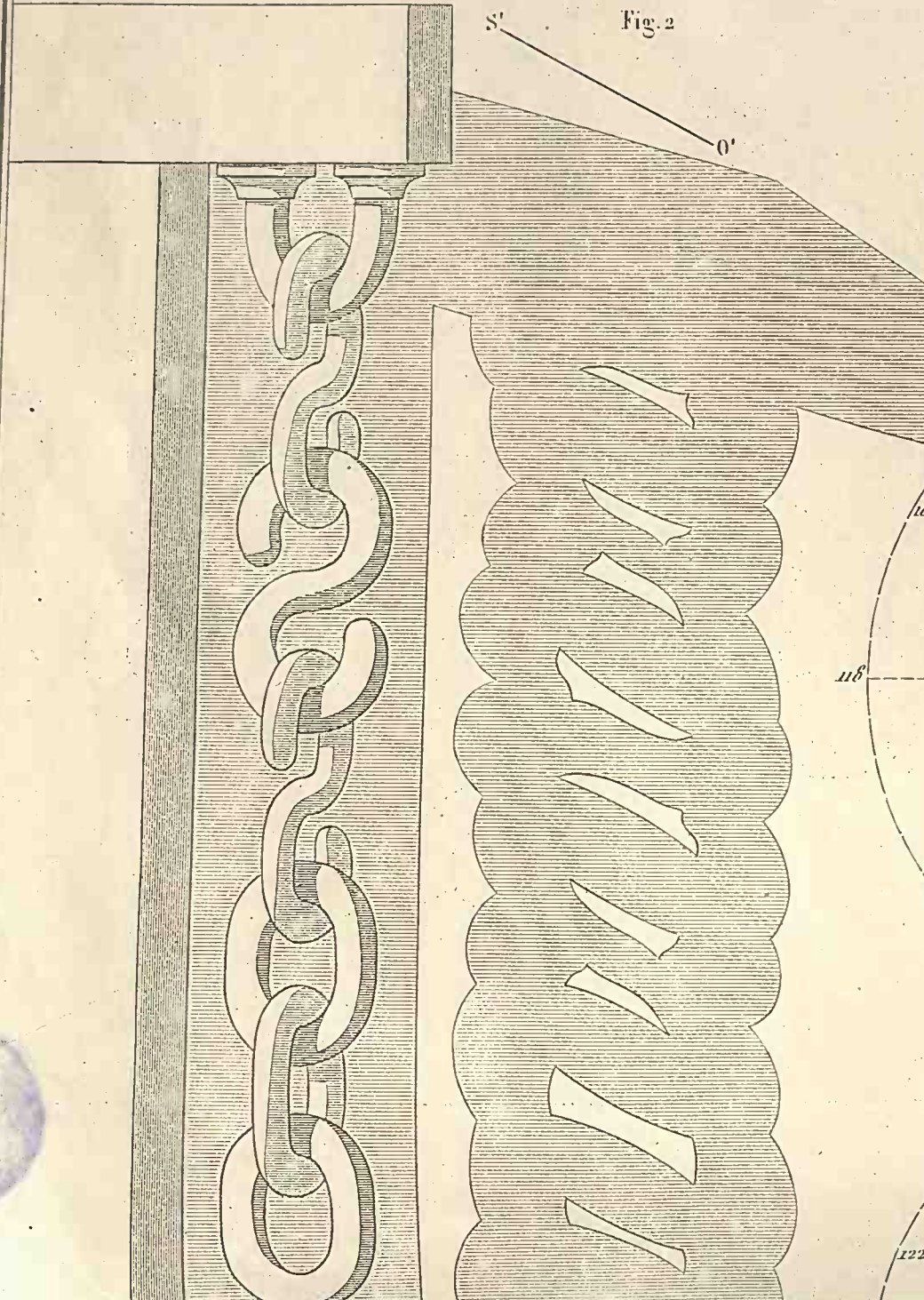
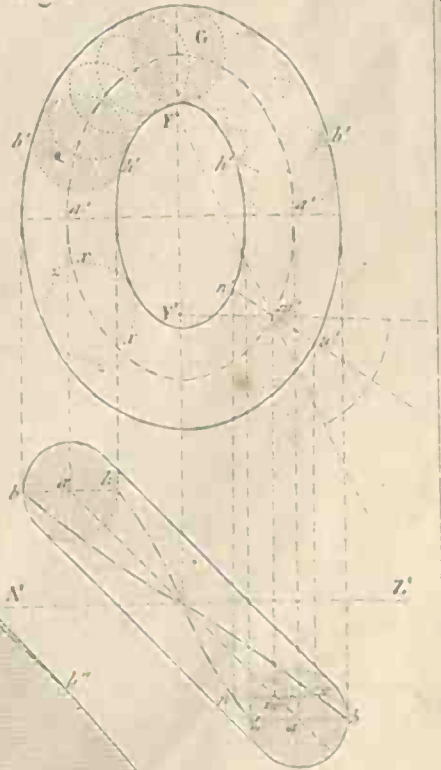

Fig. 4



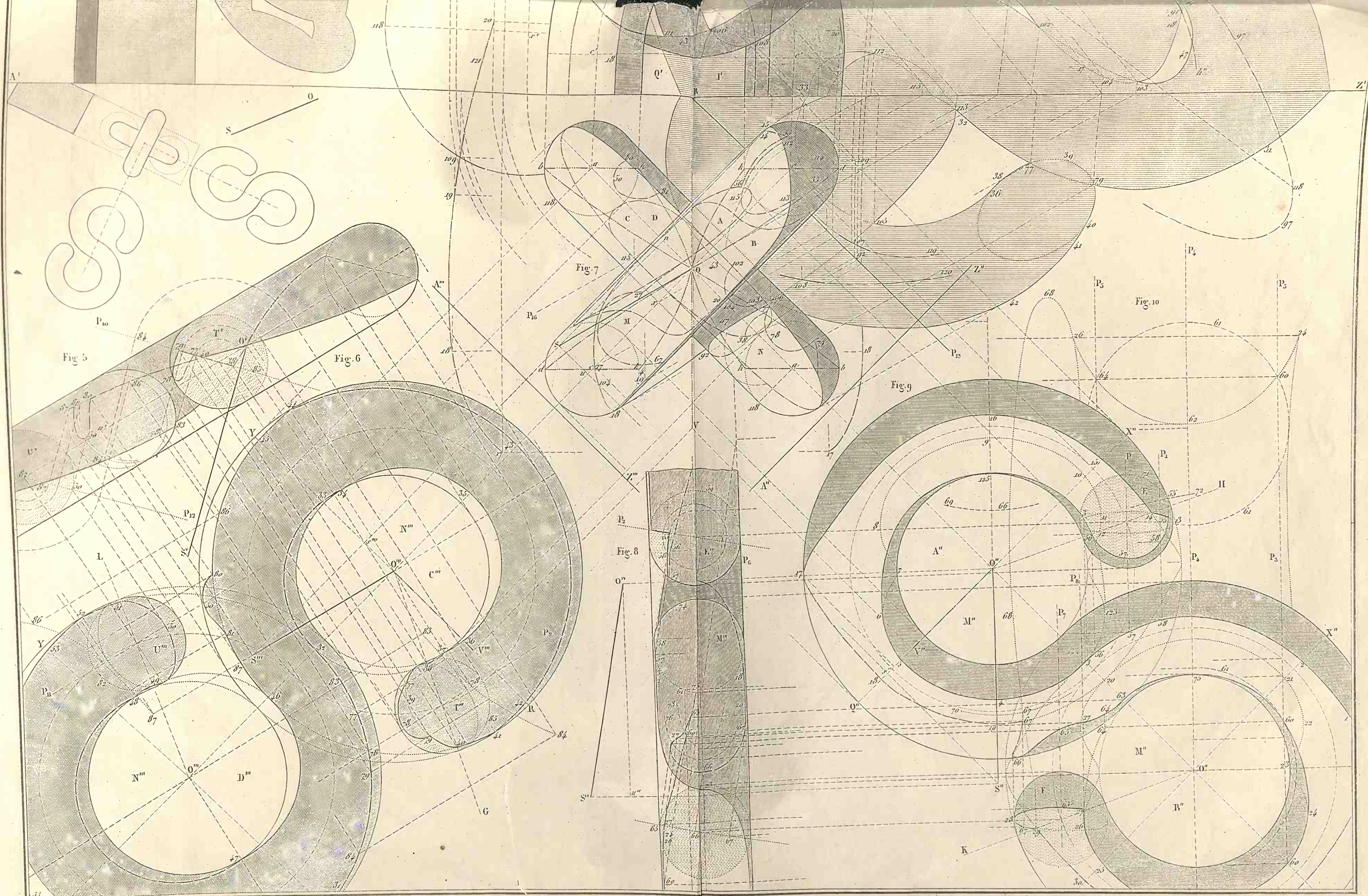

Fig. 5

Fig. 6

Fig. 7

Fig. 9

Fig. 10

Fig. 8

Ombres

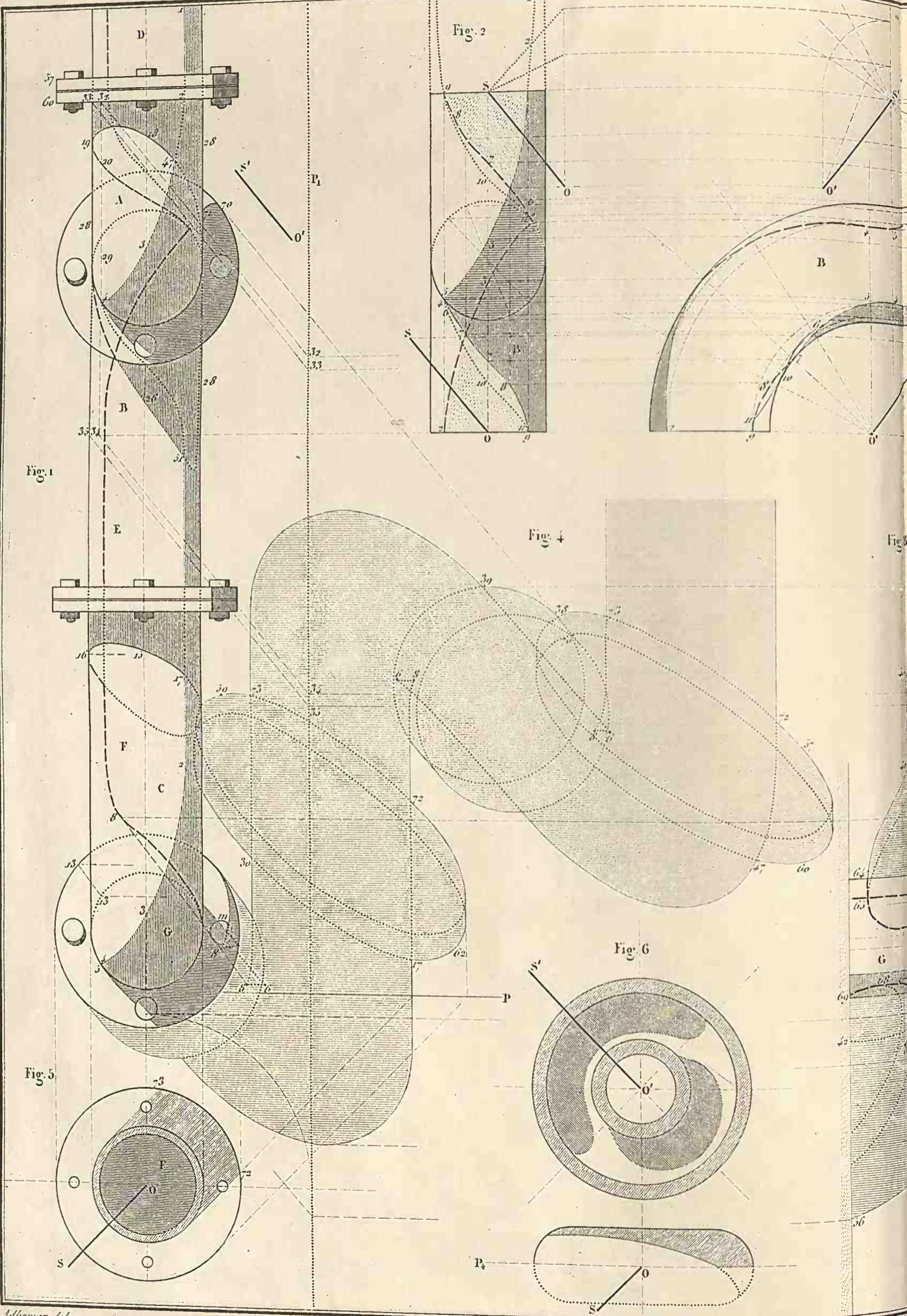

Adhemar del.

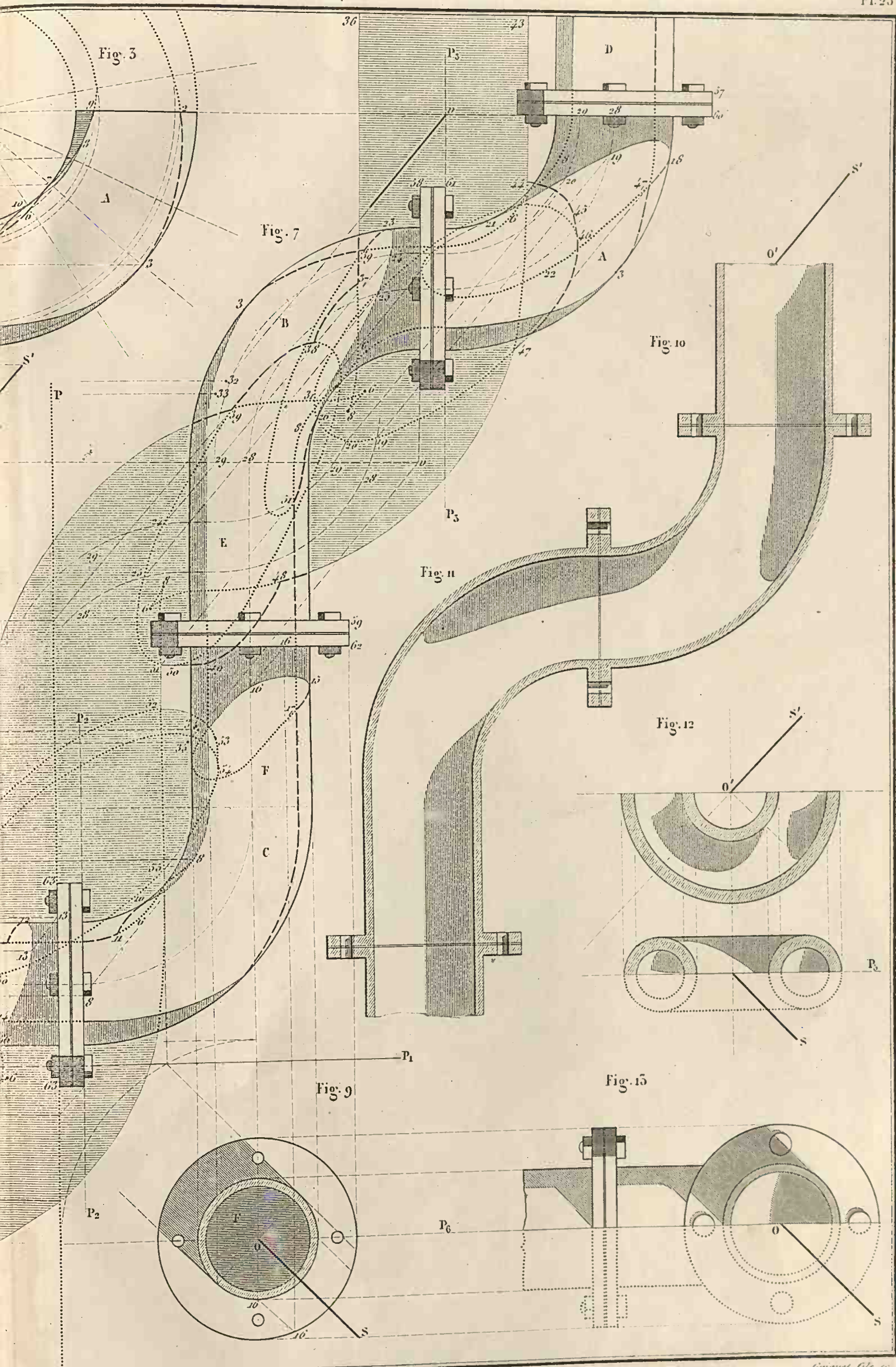

Surfaces de révolution.

Ombres.

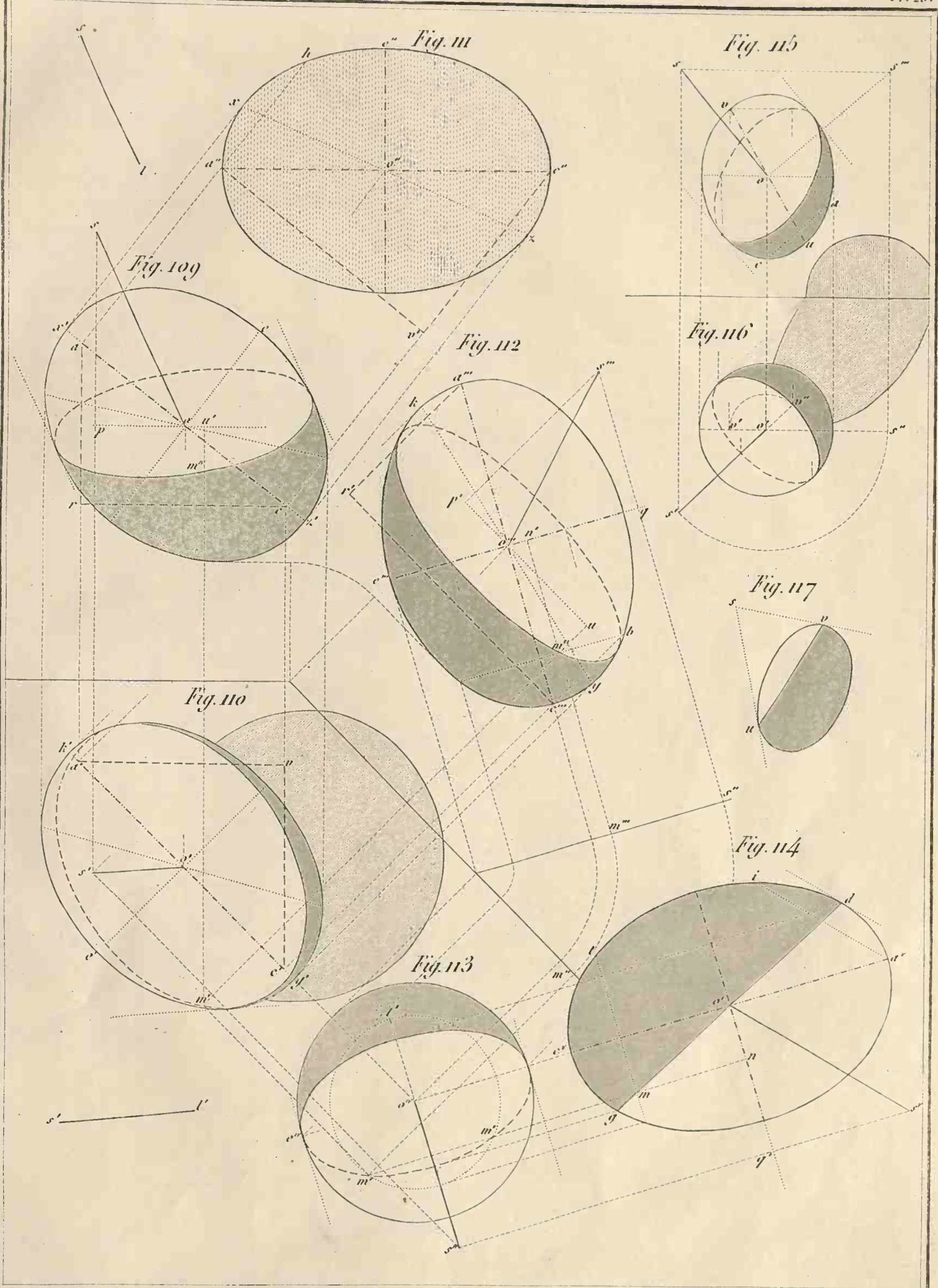

ELLIPSOÏDES

Ombres

Pl. 27.

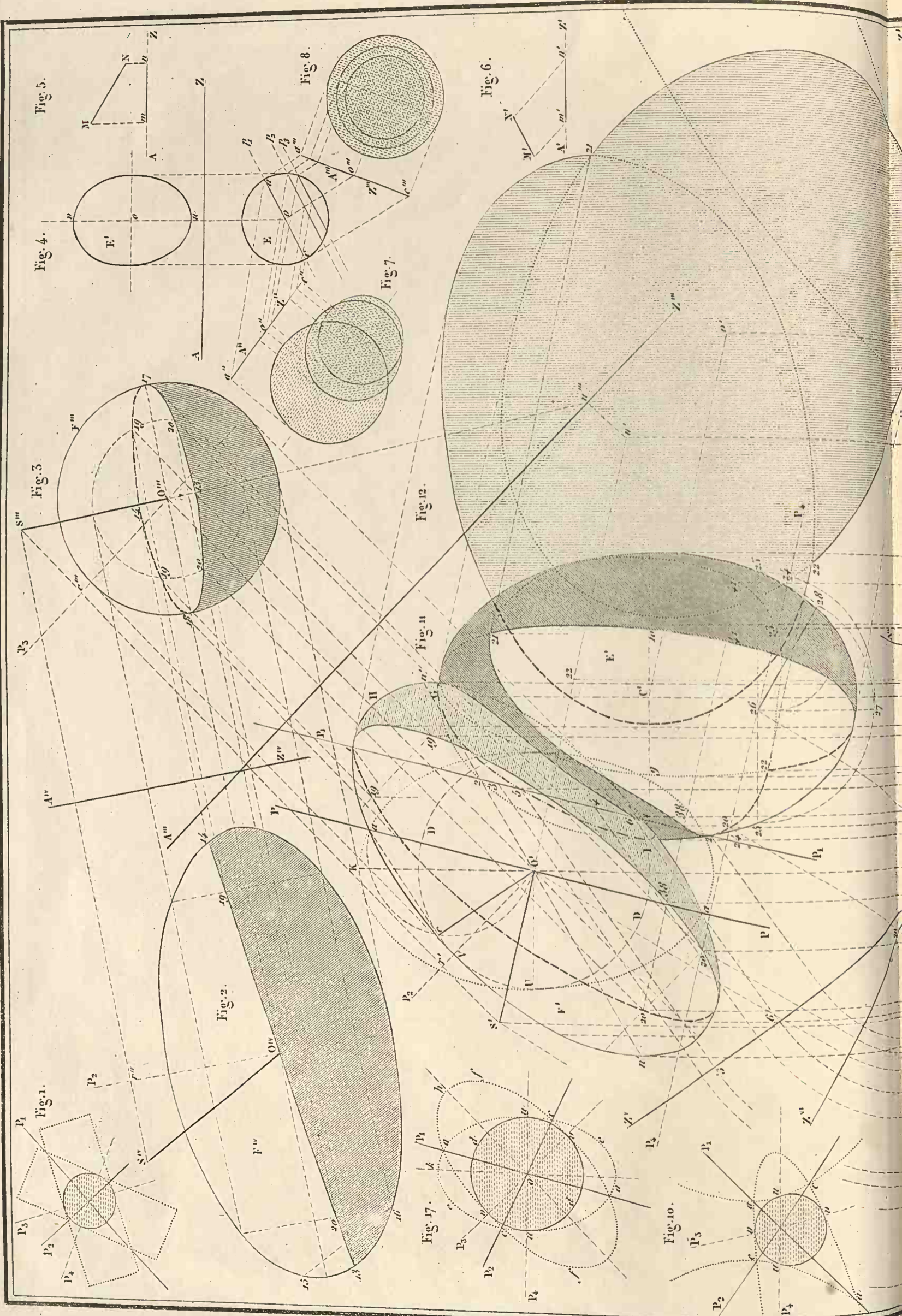

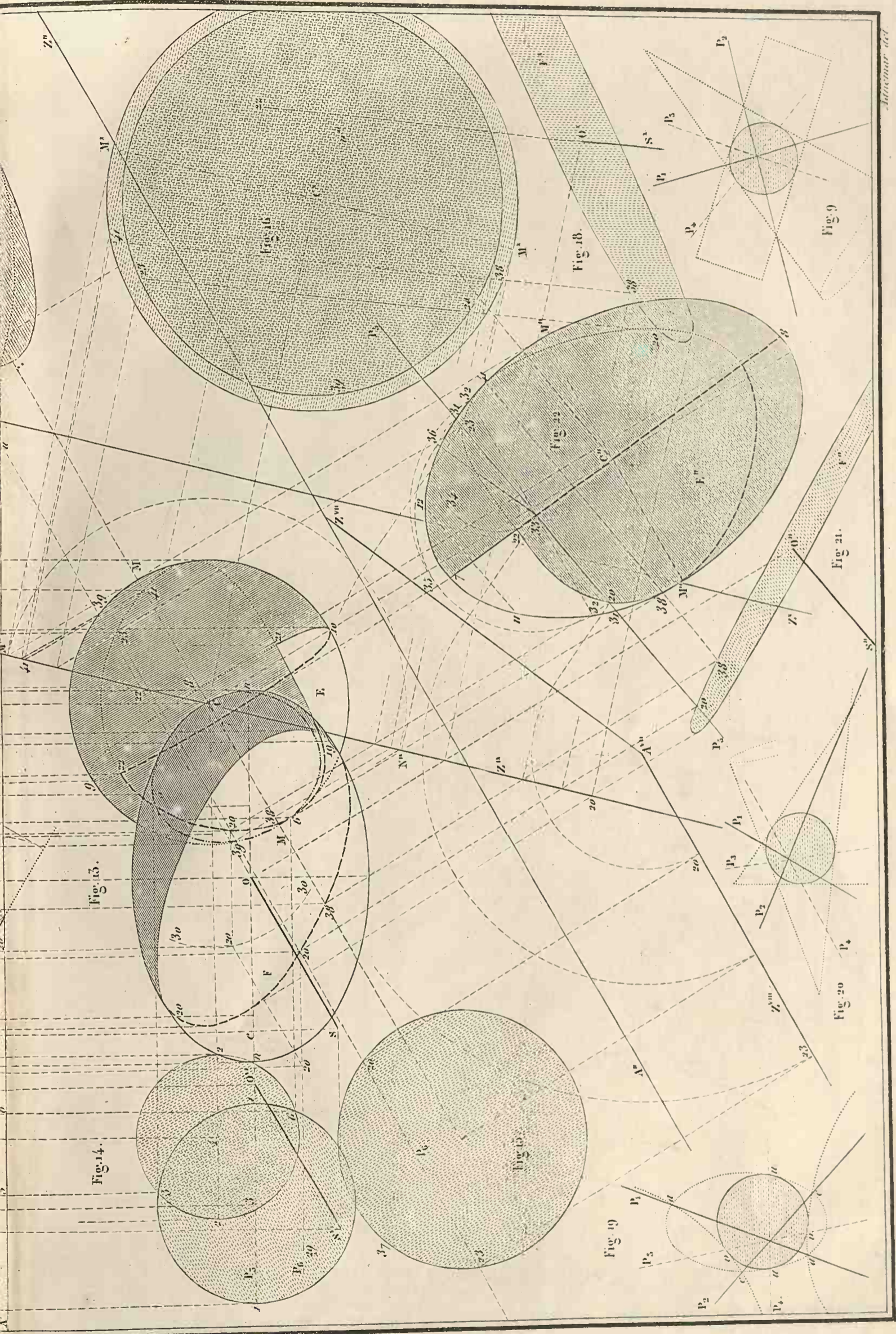

Adhemar del.

Fig. 118

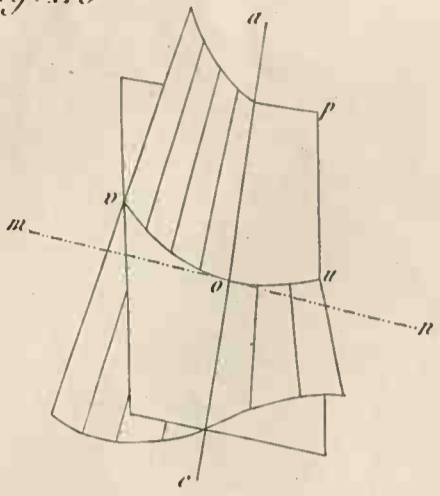

Fig. 119

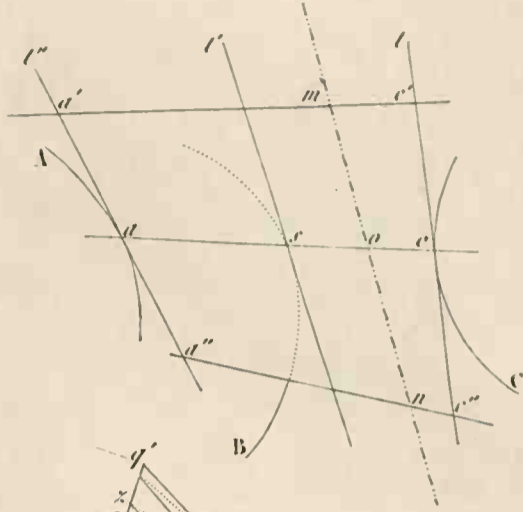

Fig. 120

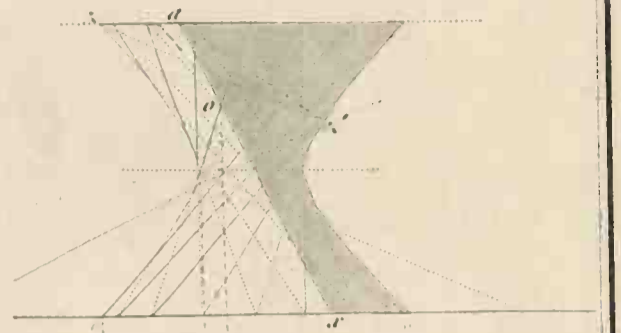

Fig. 121

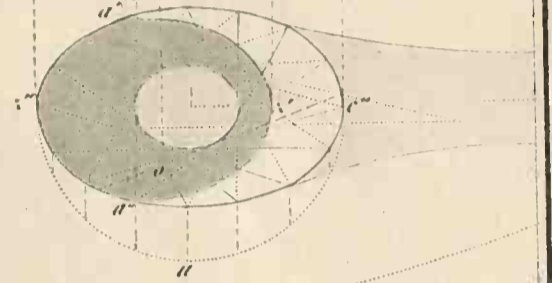

Fig. 122

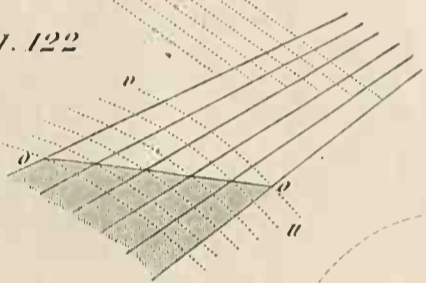

Fig. 123

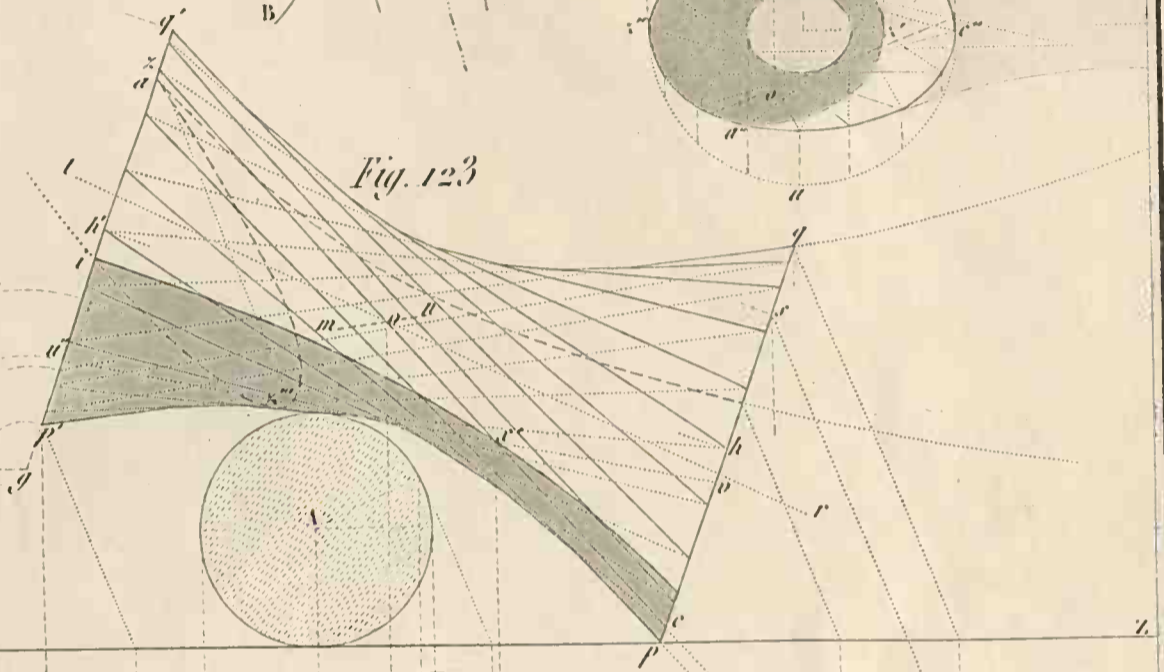

Fig. 124

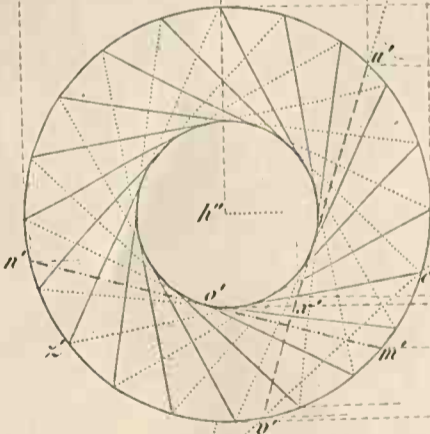
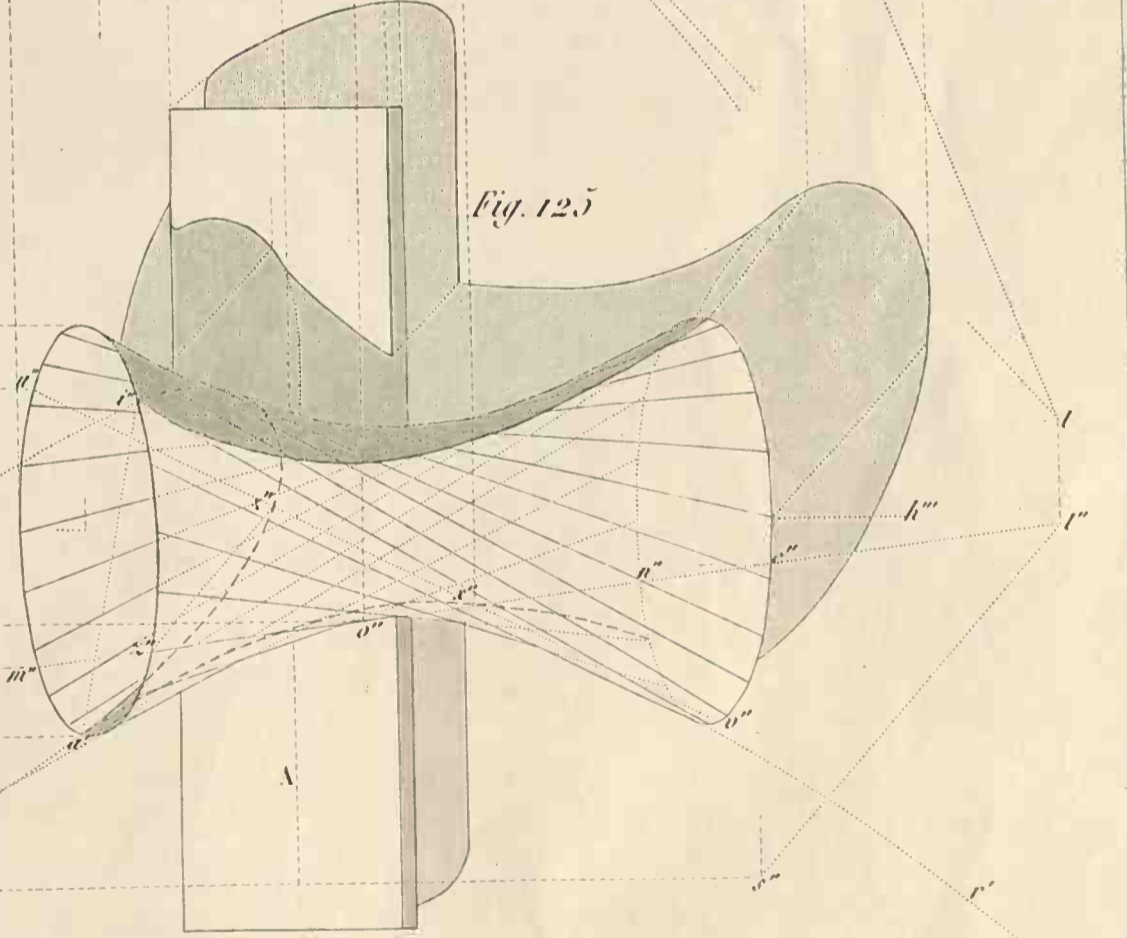
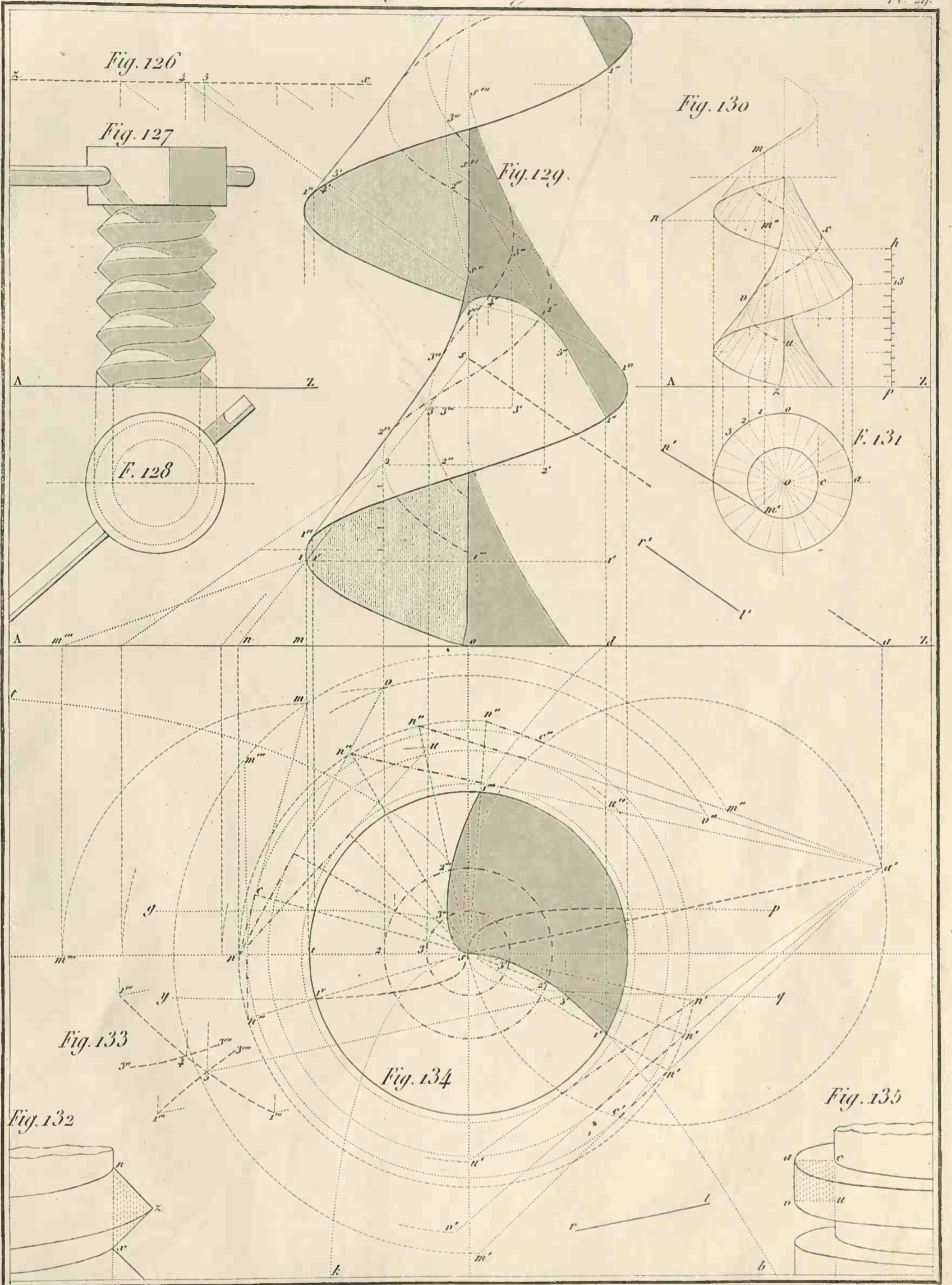

Fig. 125





Surfaces réglées.

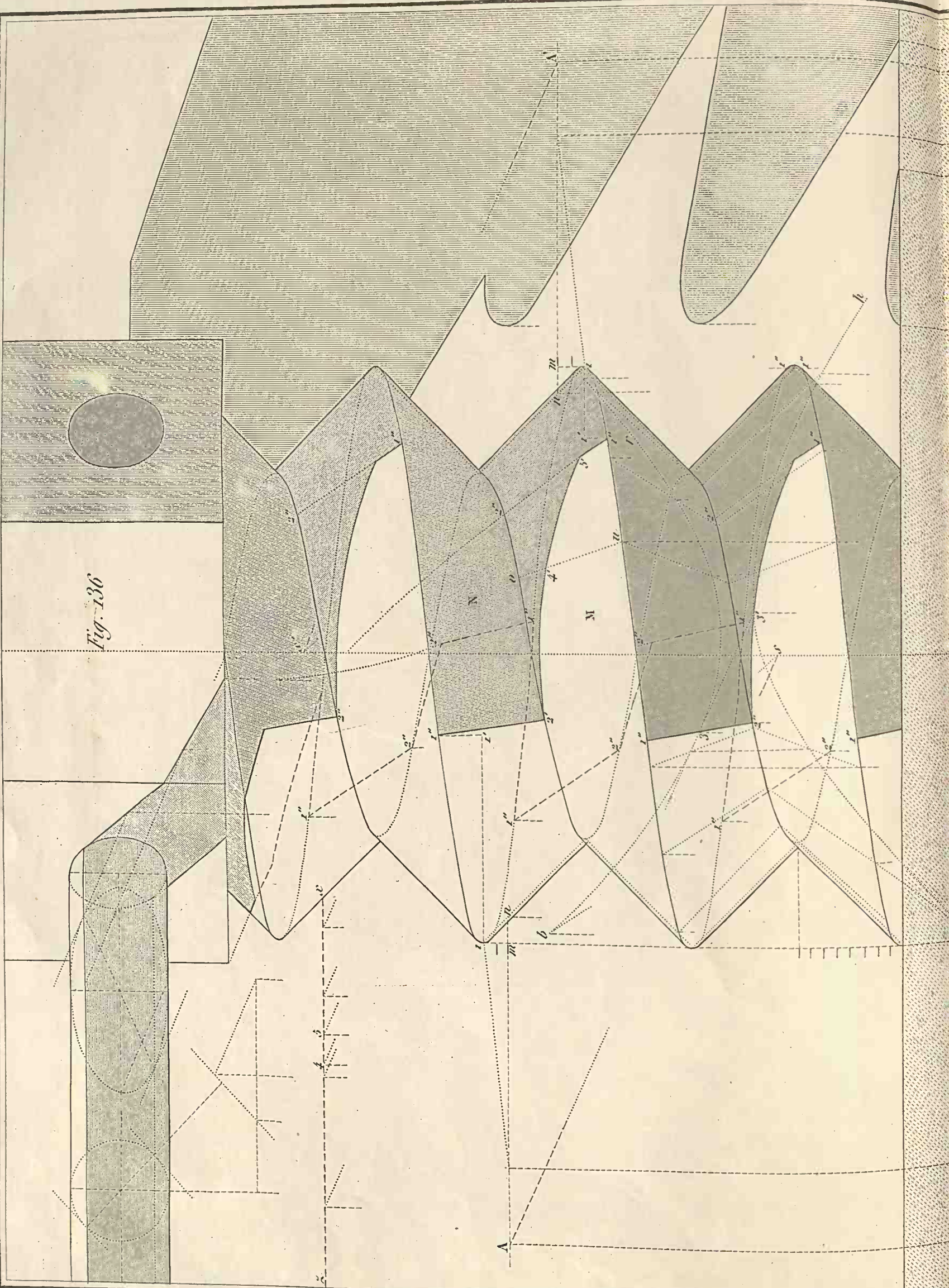

Fig. 136

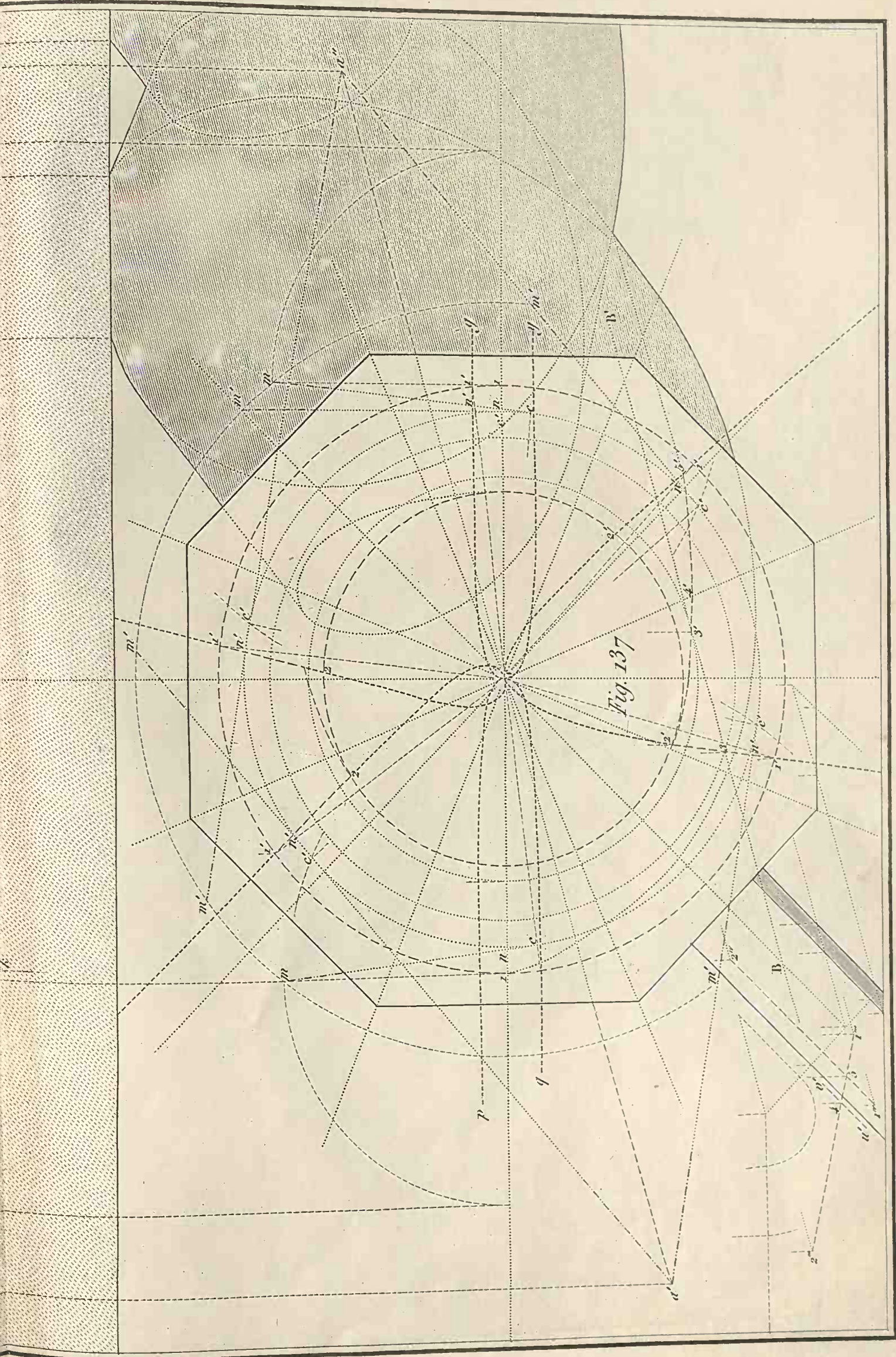

Fig. 137

Fig. 138

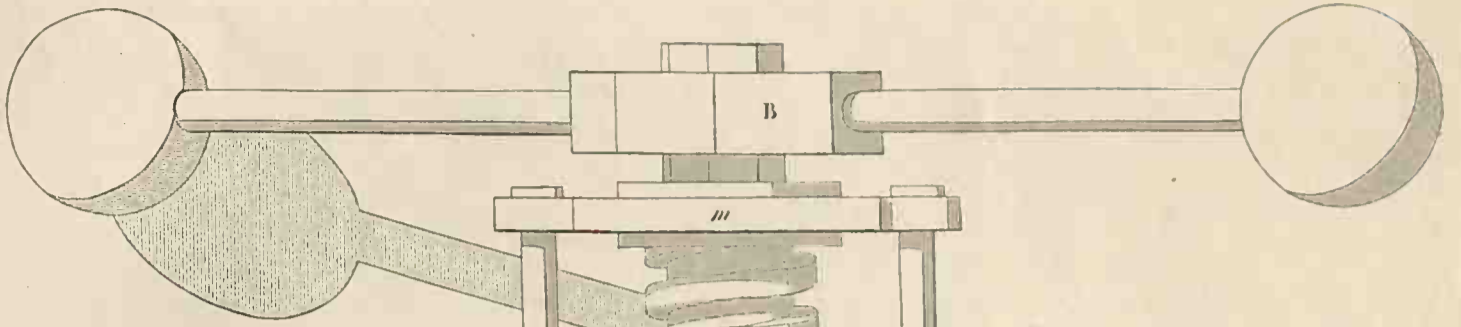

Fig. 140

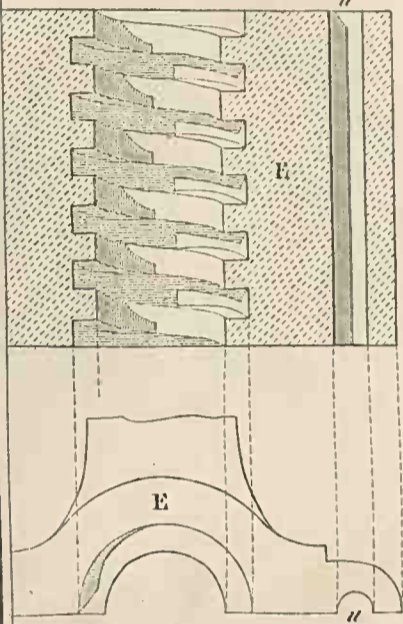
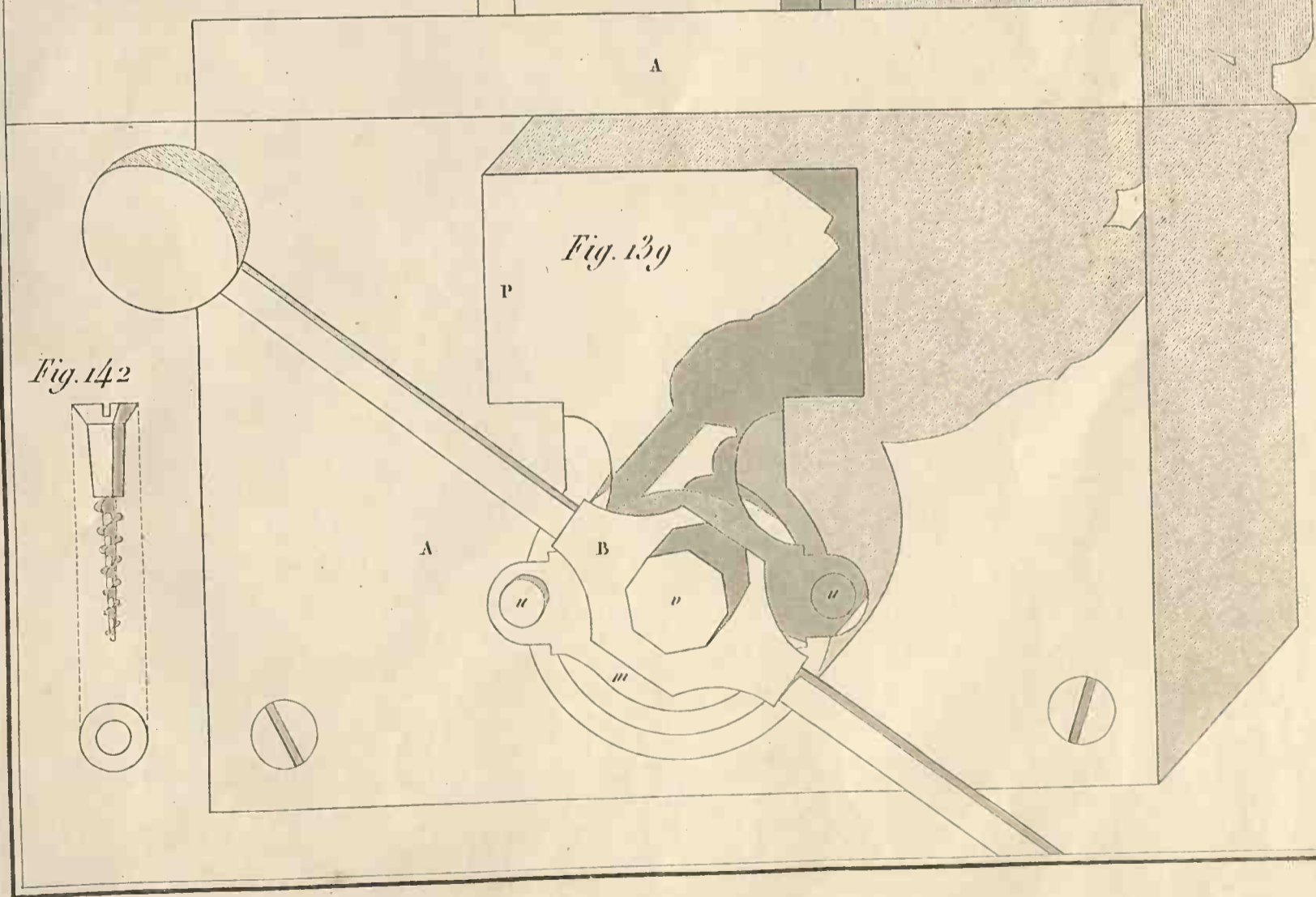
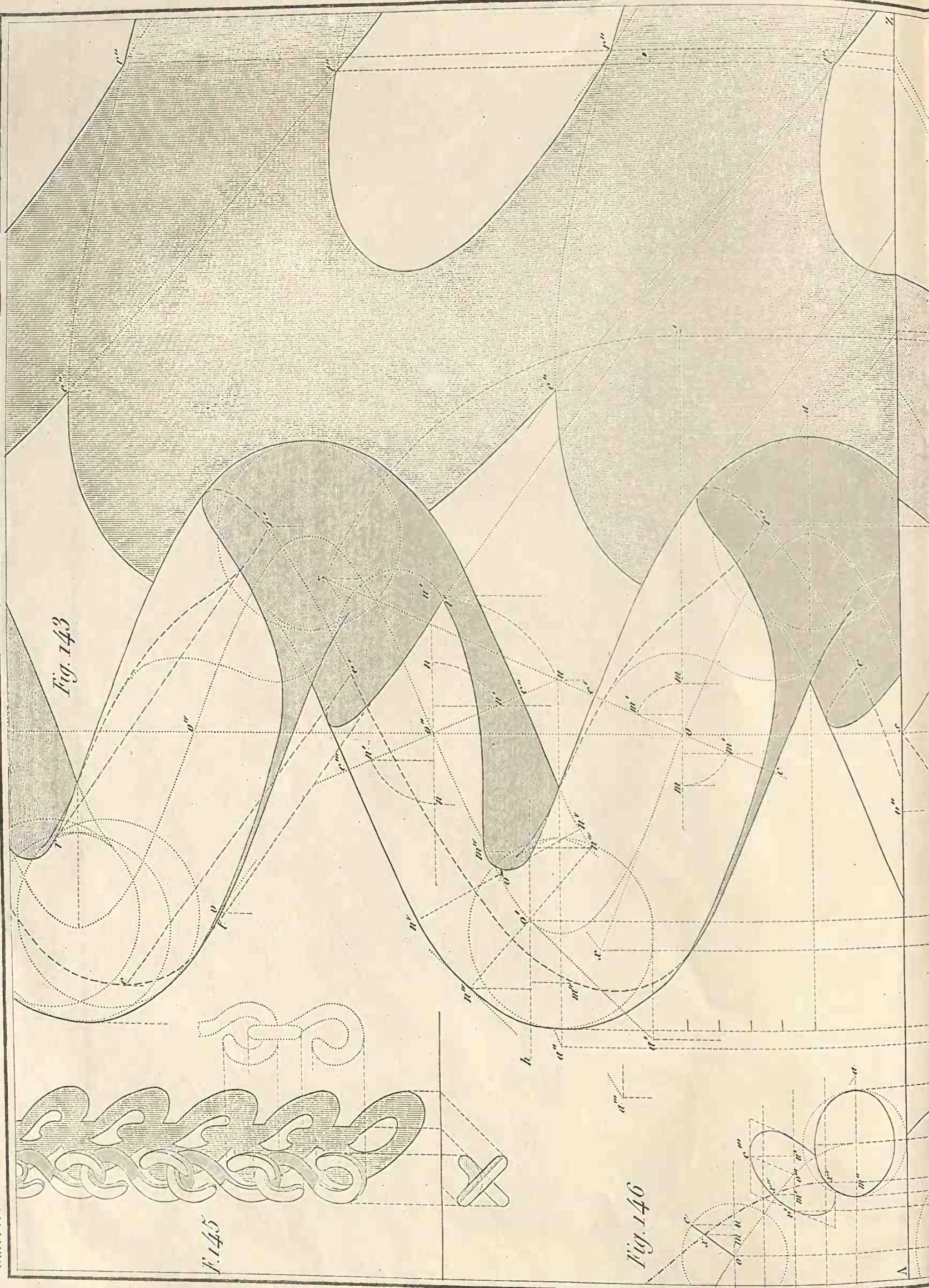

Fig. 141



Surfaces enveloppes.



Ombres.

Fig. 143

Fig. 145

Fig. 146

Fig. 148

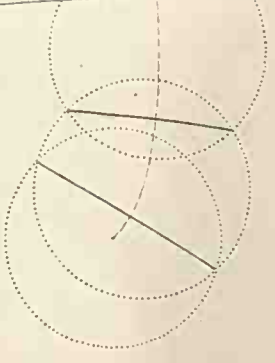

Fig. 149

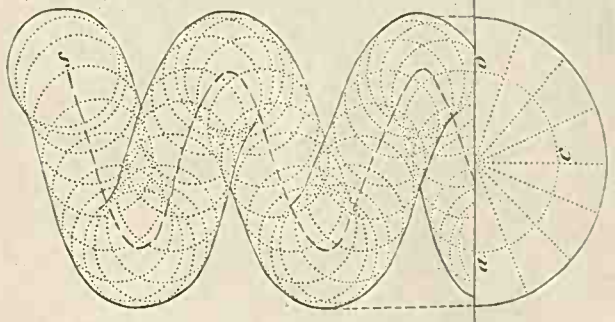

Fig. 150

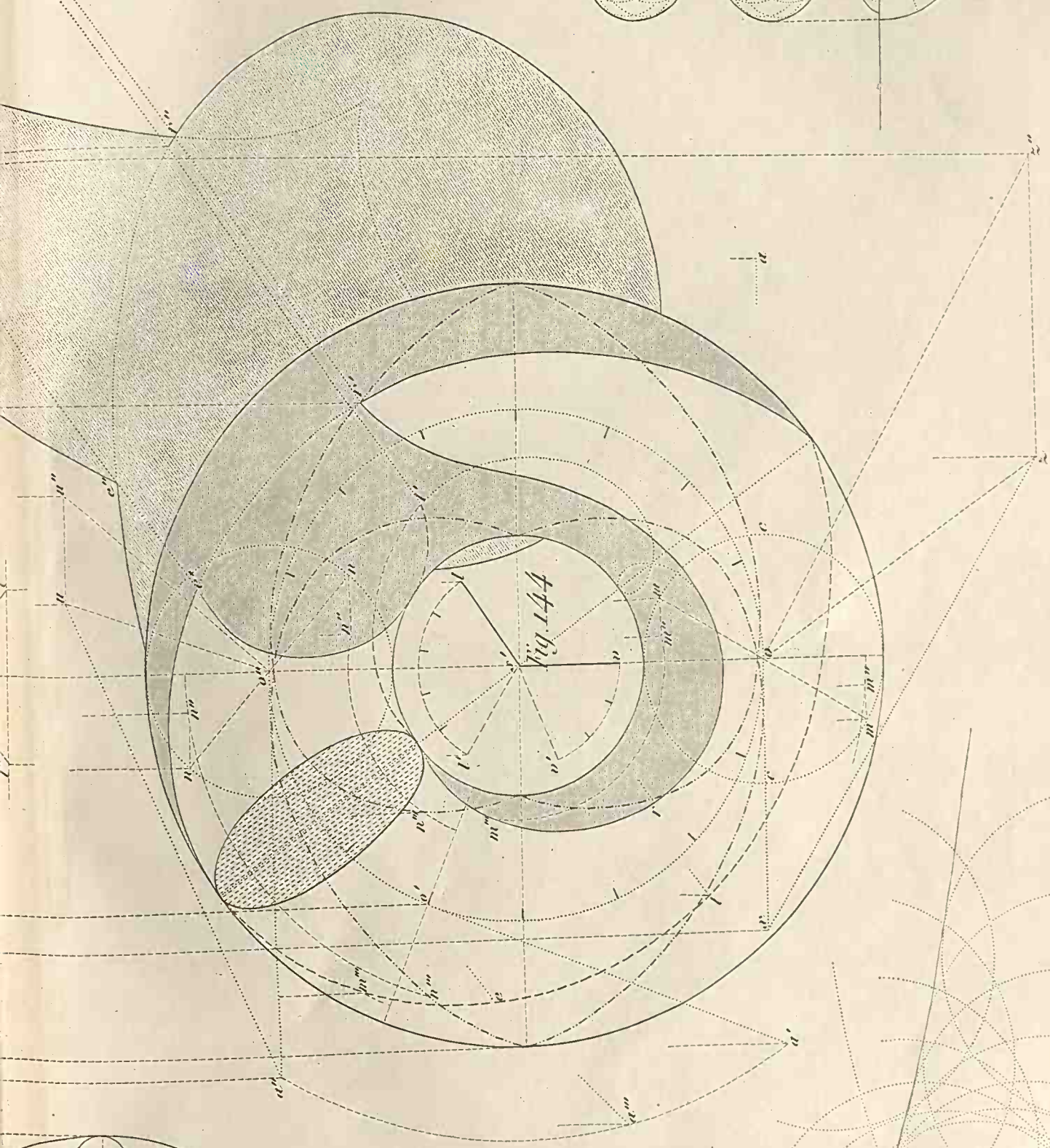

Fig. 147

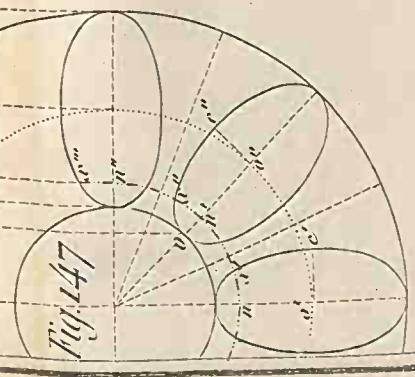
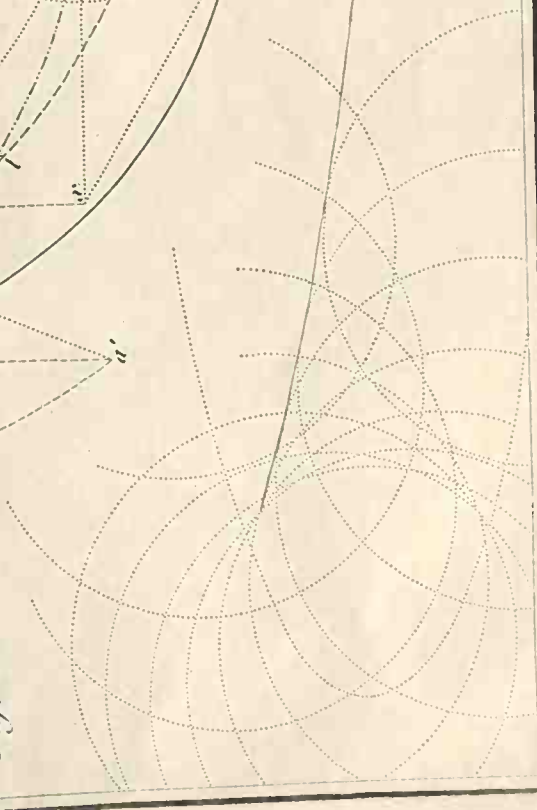

Fig. 151



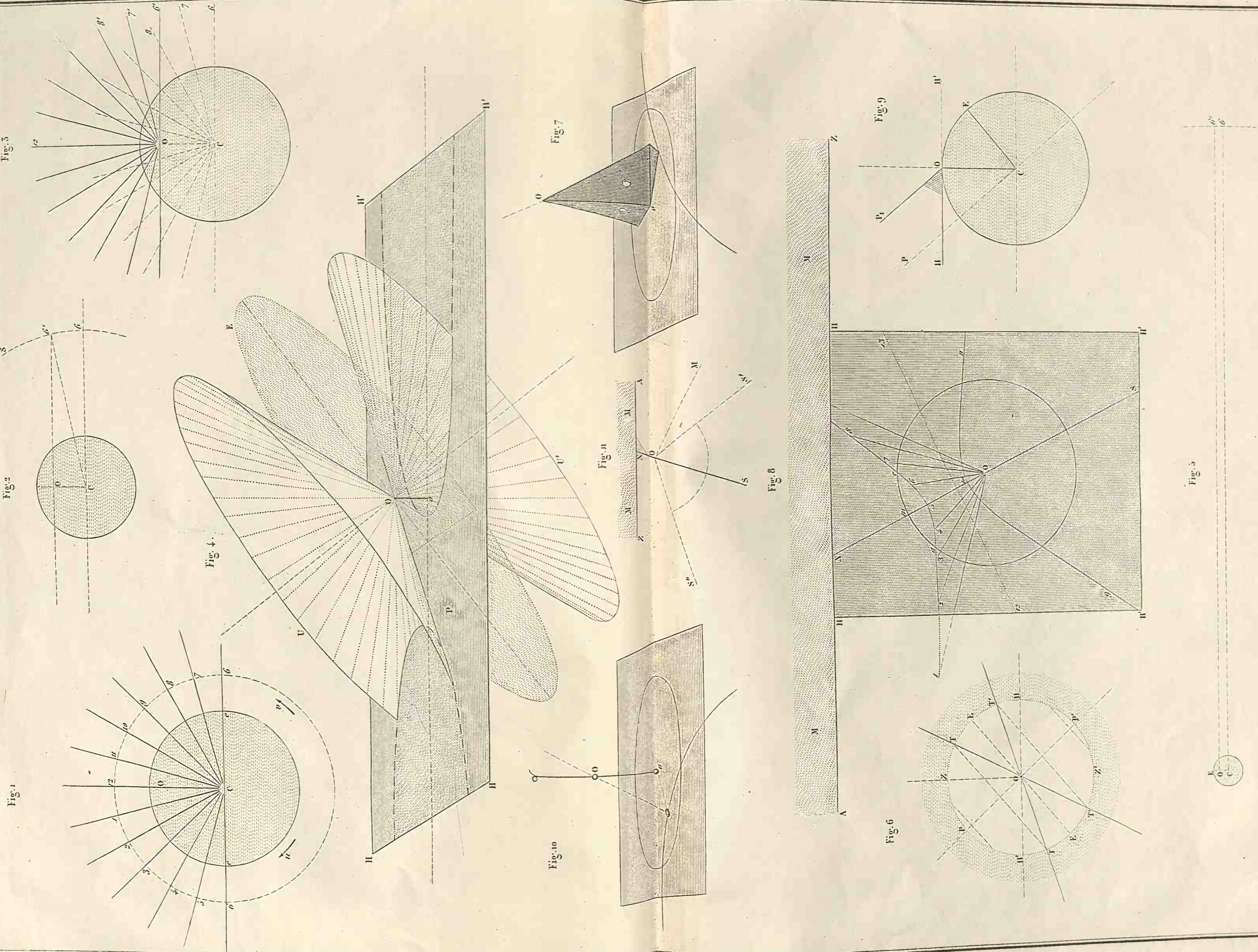

Fig. 1

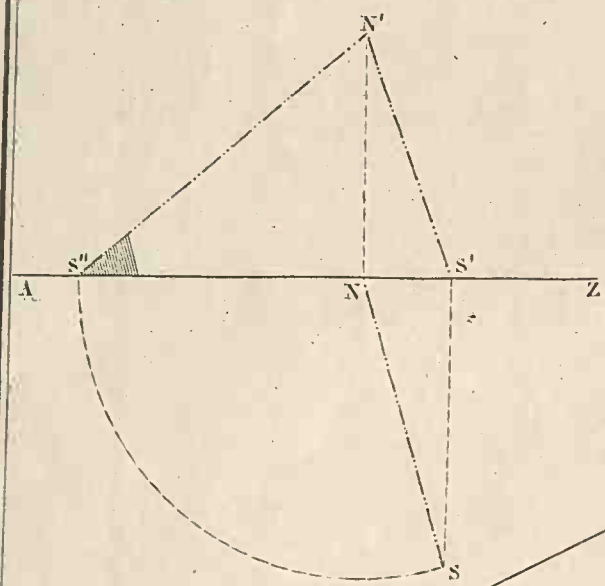

Fig. 2

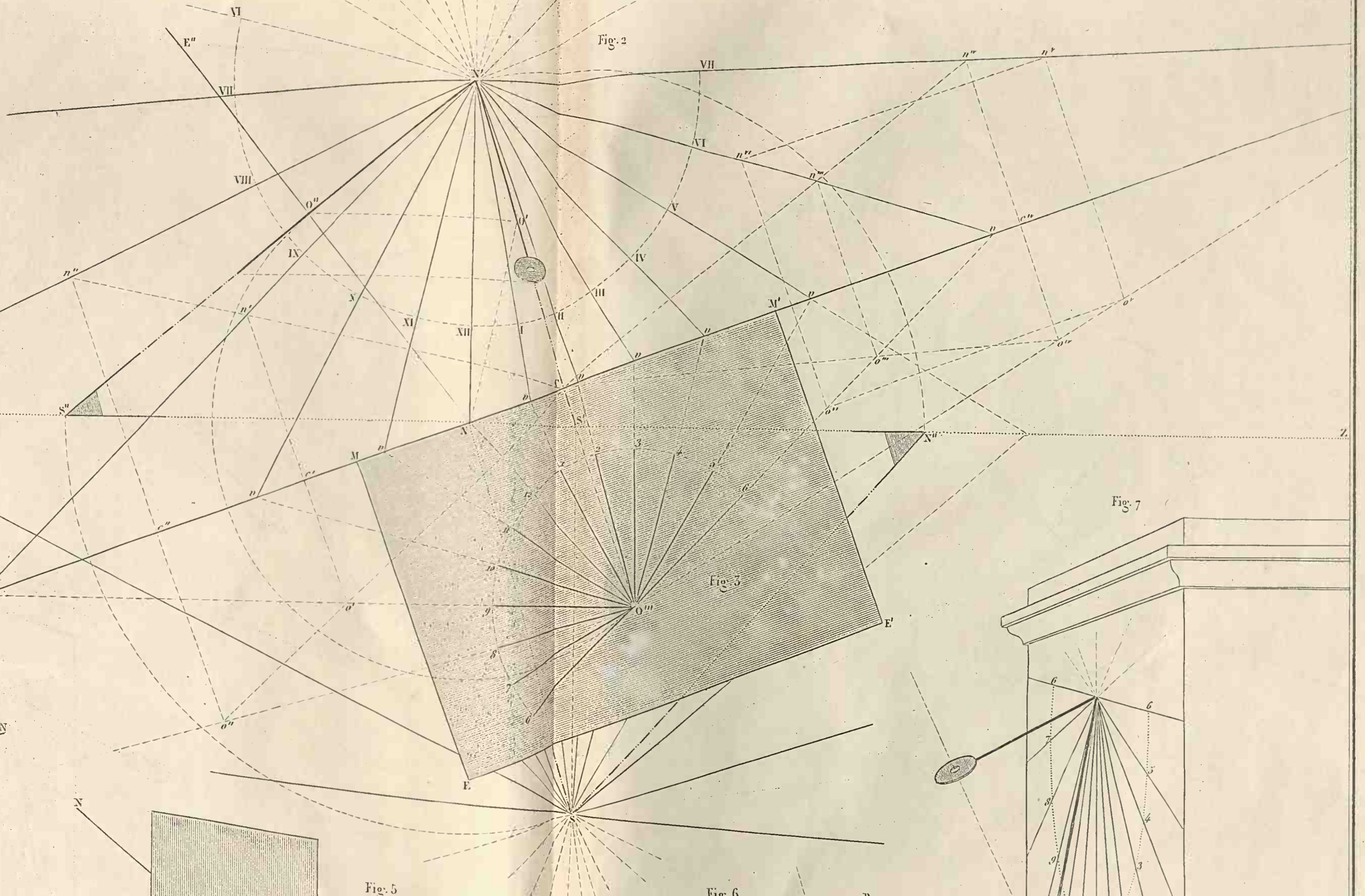

Fig. 7

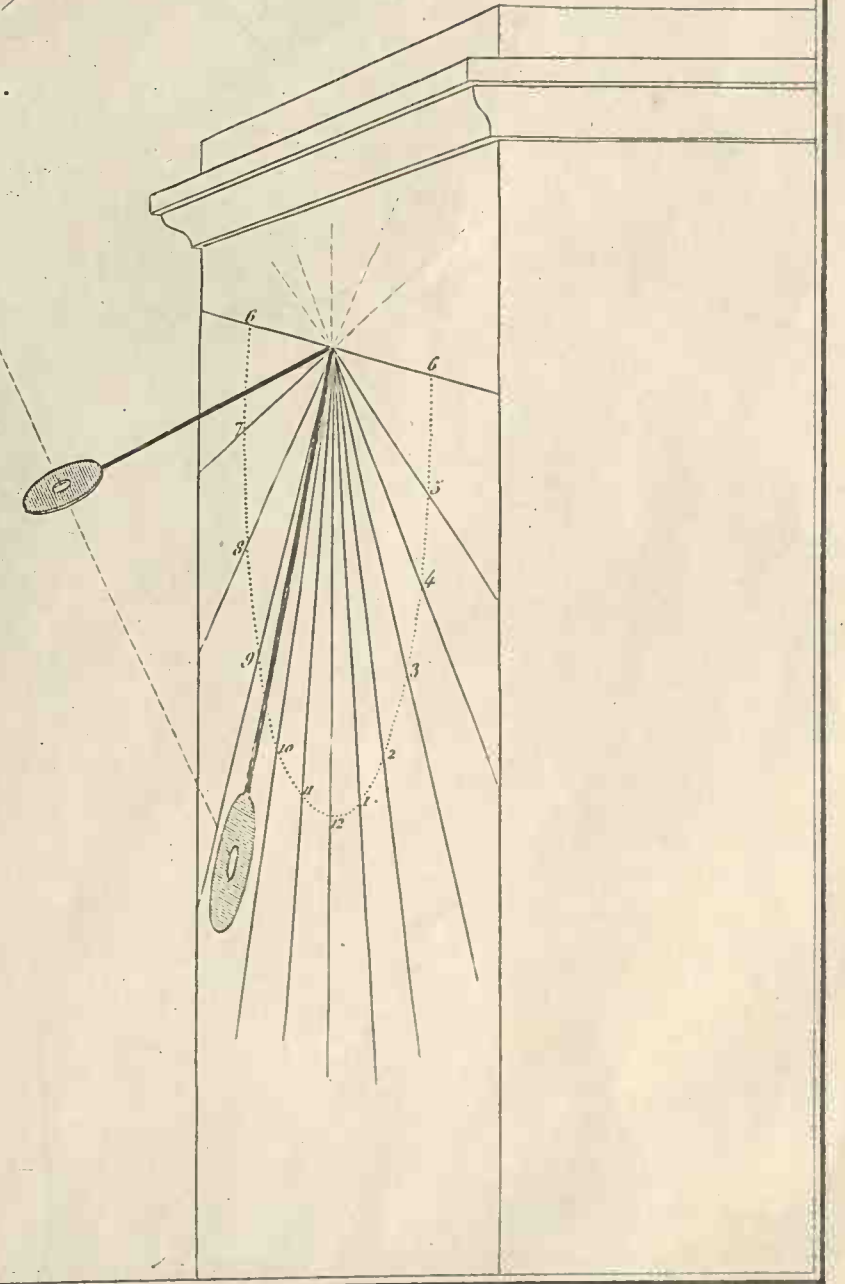

Fig. 4

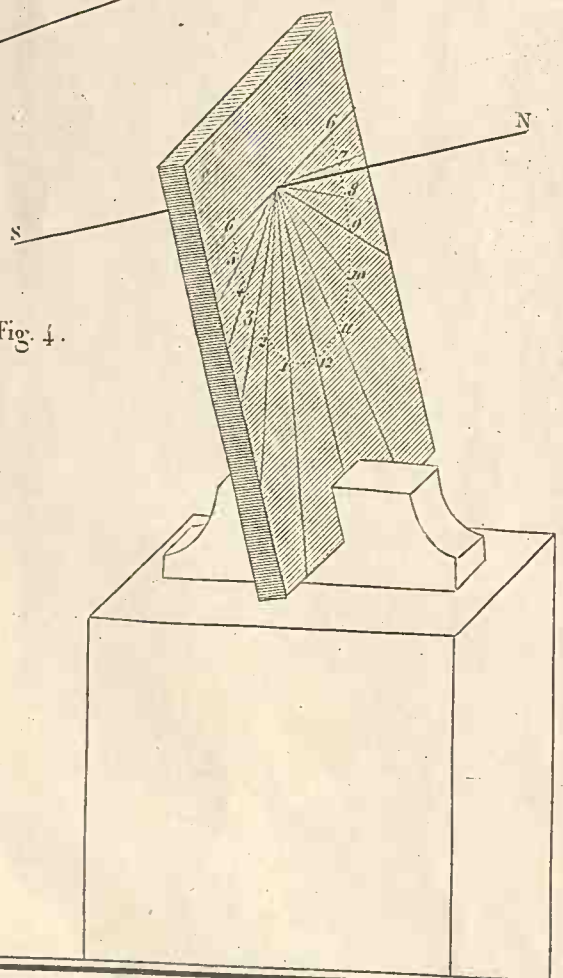

Fig. 5

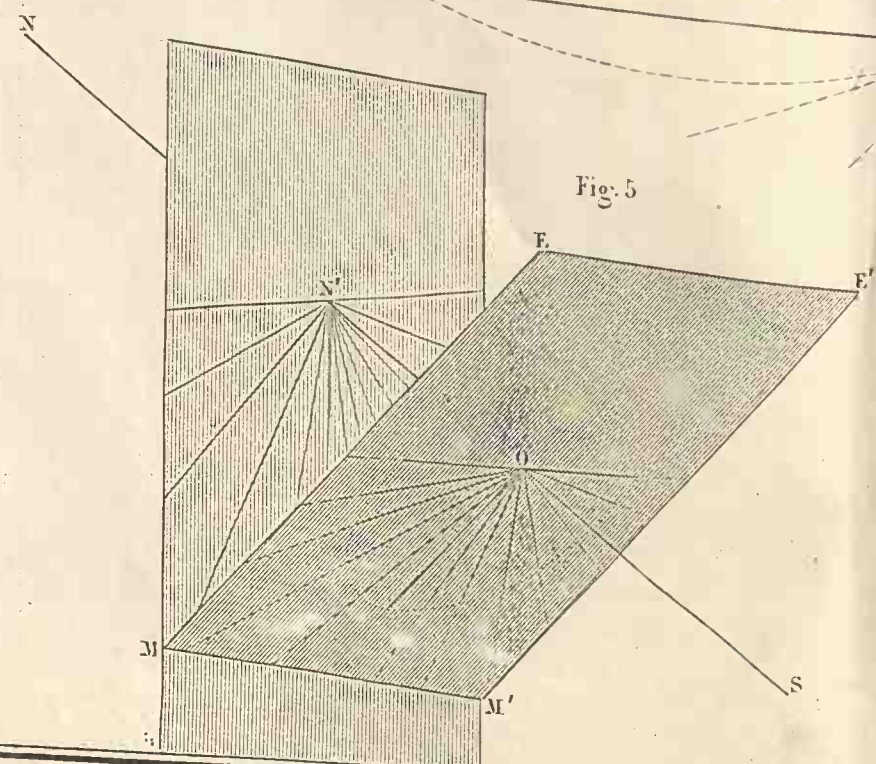

Fig. 6

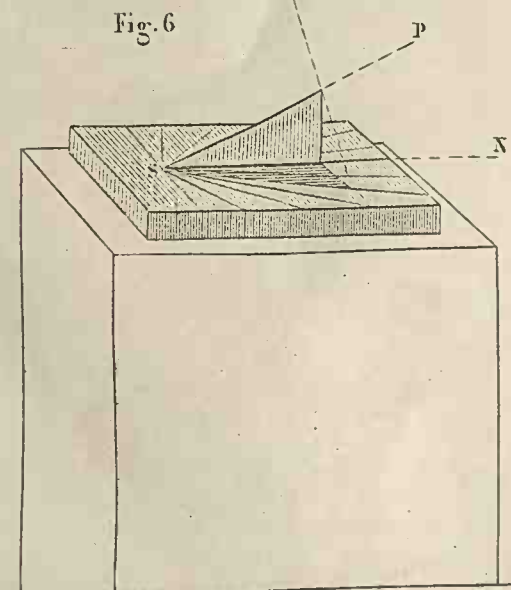

Fig. 152

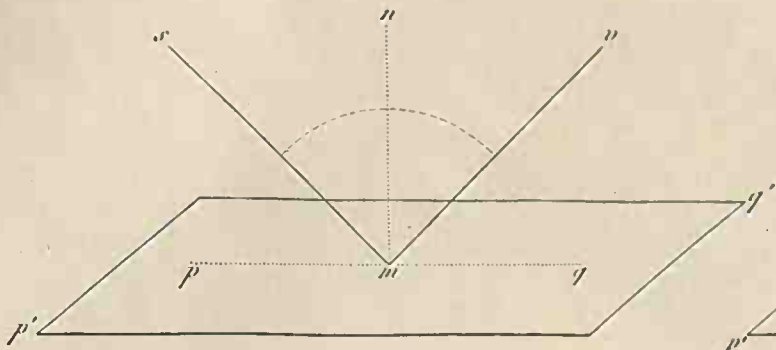

Fig. 153

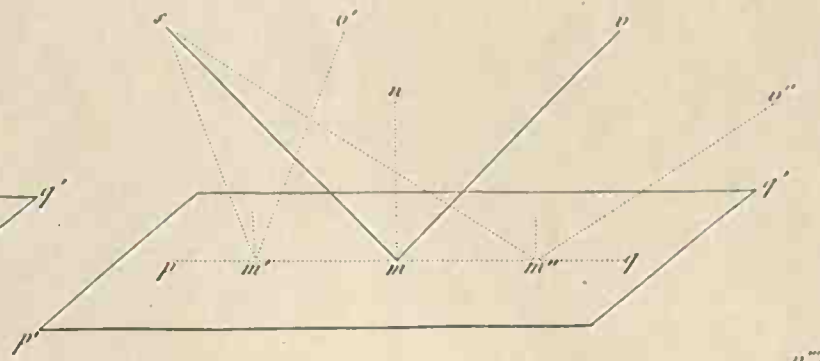

Fig. 154

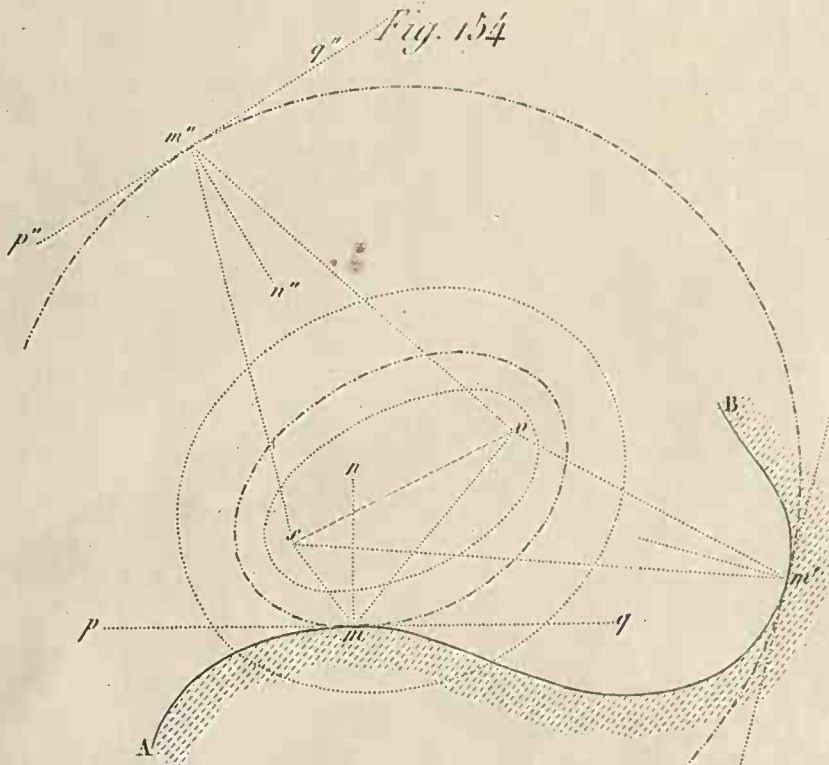

Fig. 155

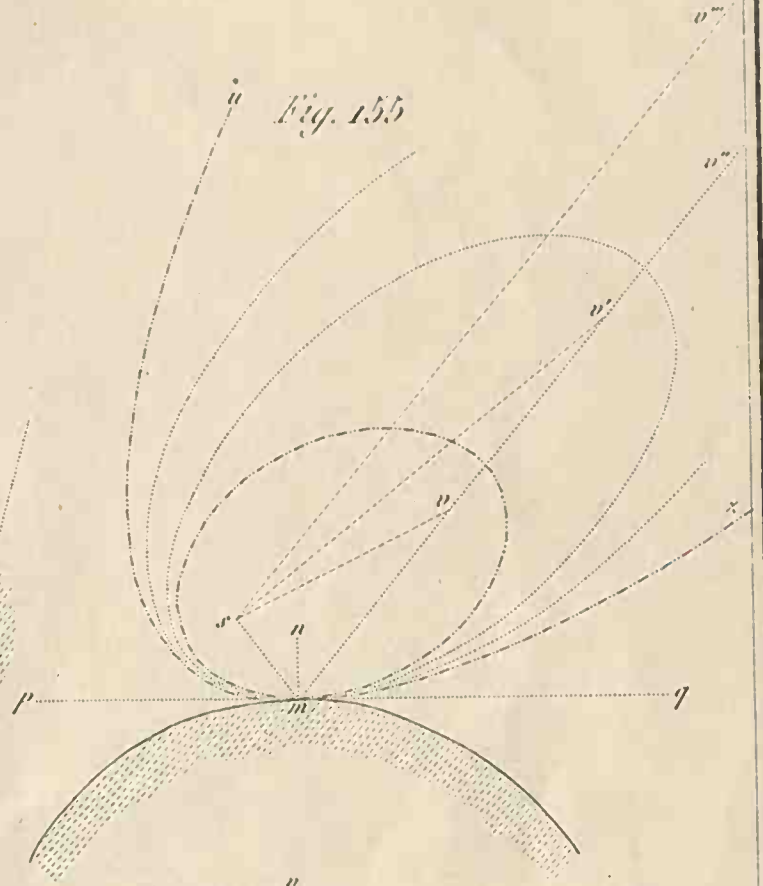

Fig. 156

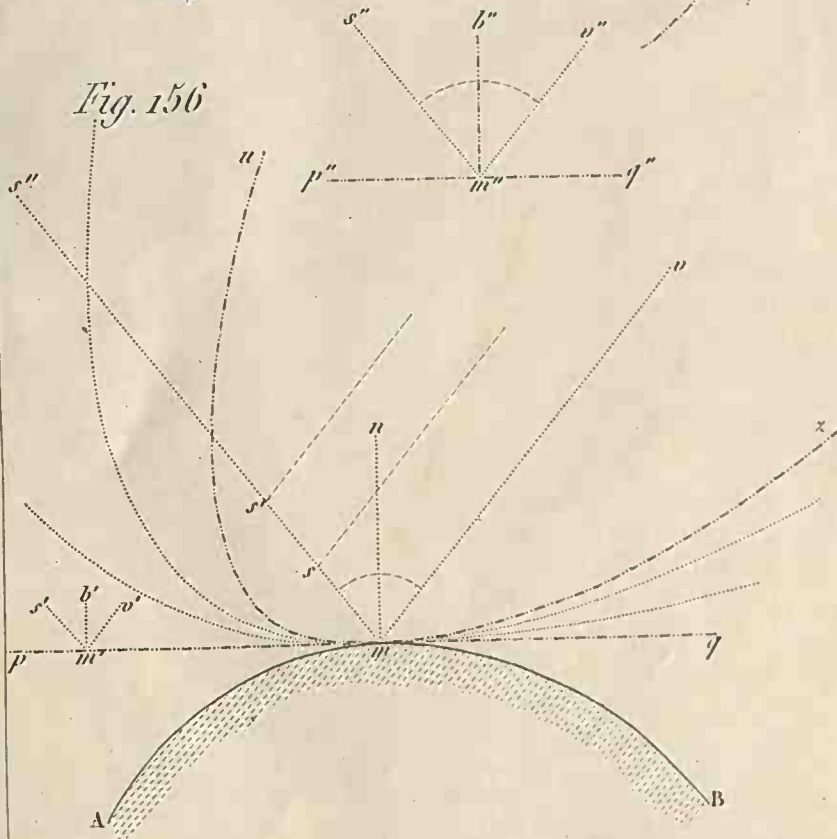

Fig. 157

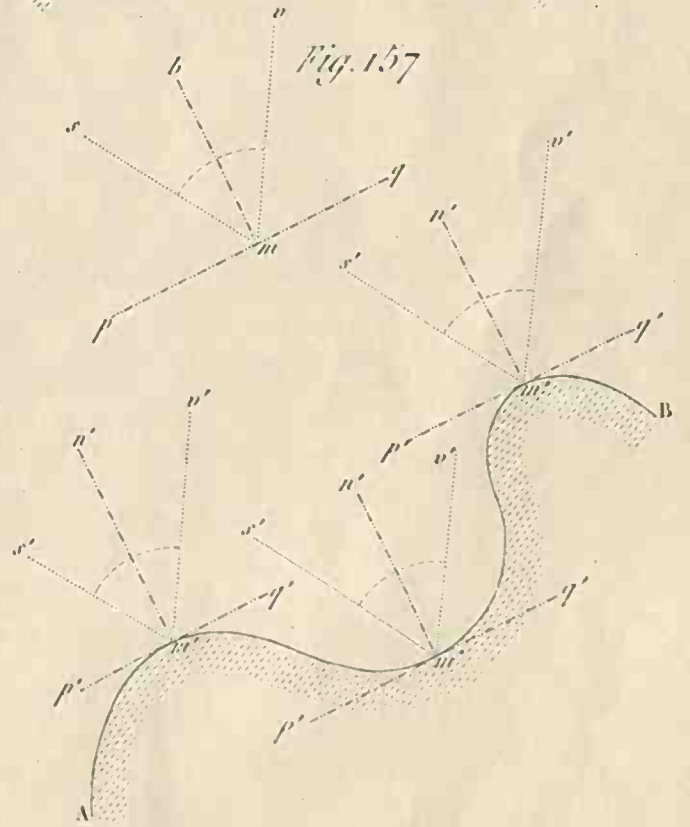

Fig. 158

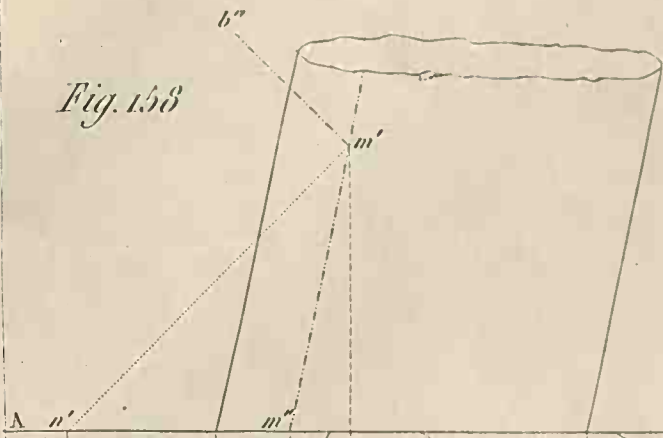

Fig. 160

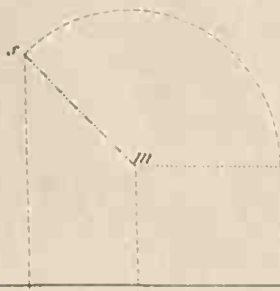

Fig. 162

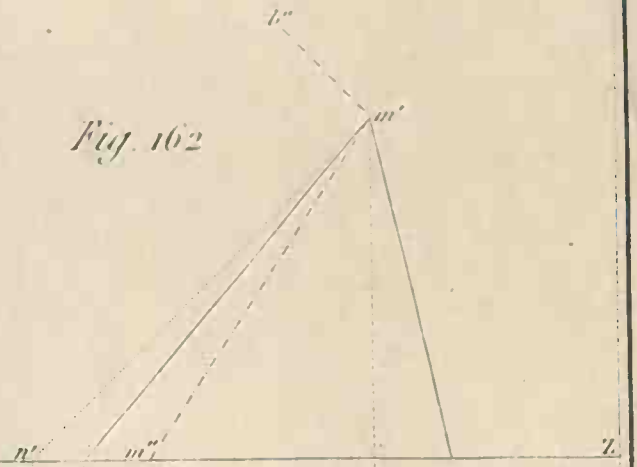

Fig. 159

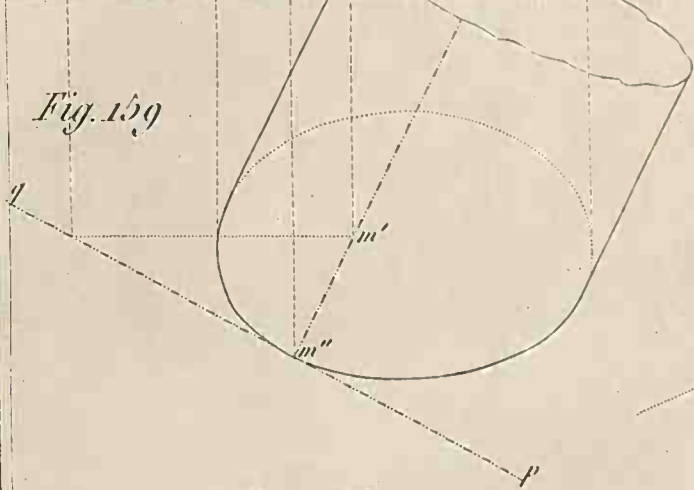

Fig. 161

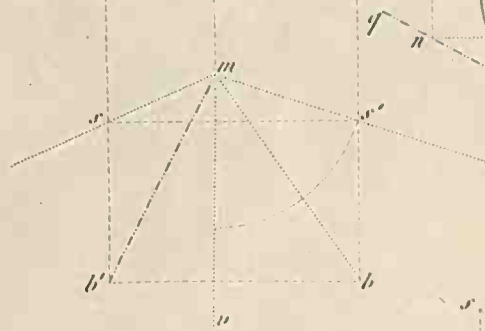

Fig. 163

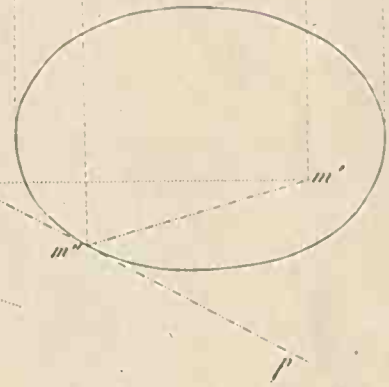

Fig. 164

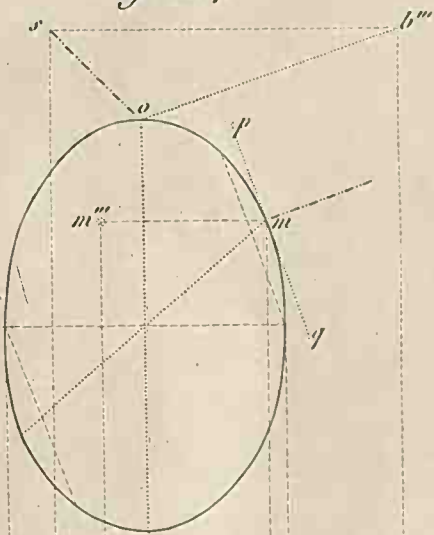

Fig. 166

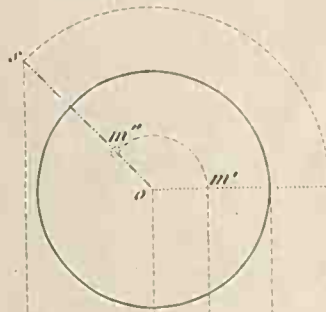

Fig. 168

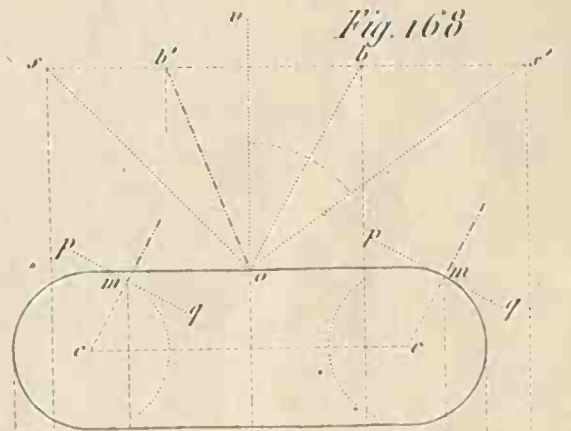

Fig. 165

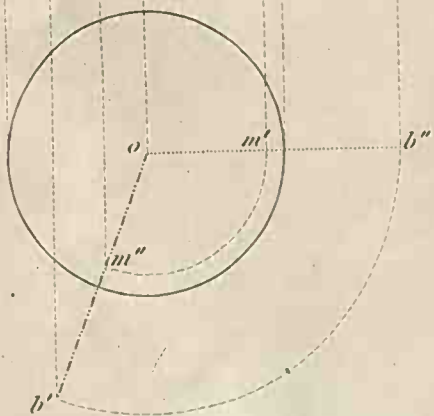
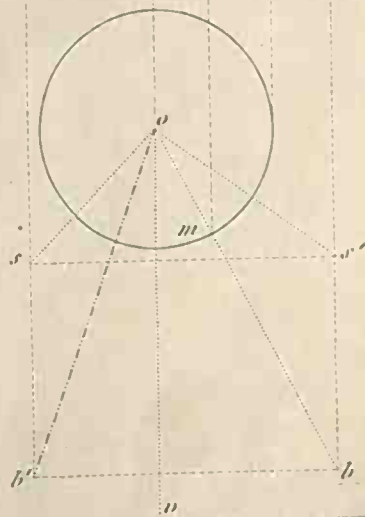

Fig. 167



F. 169

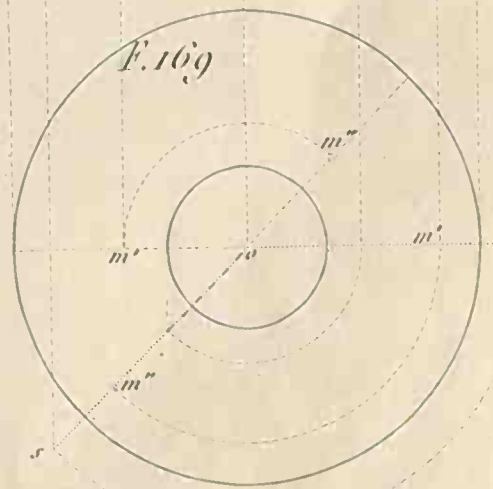

Fig. 179

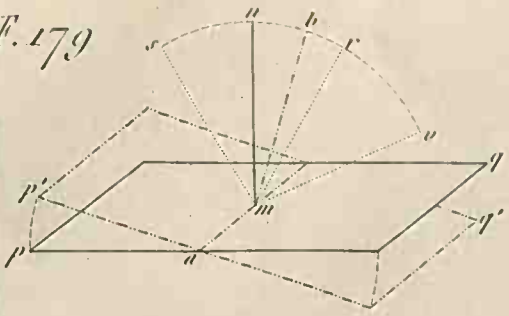

Fig. 180

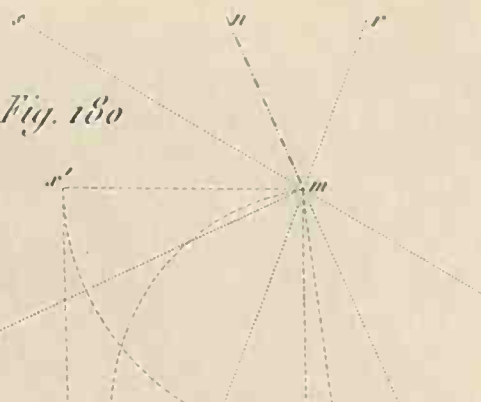

Fig. 182

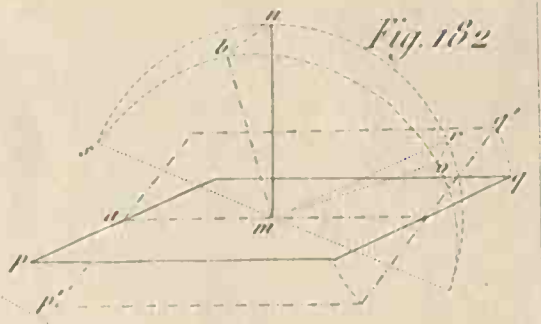

Fig. 183

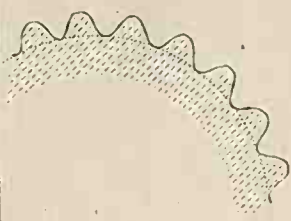

Fig. 181

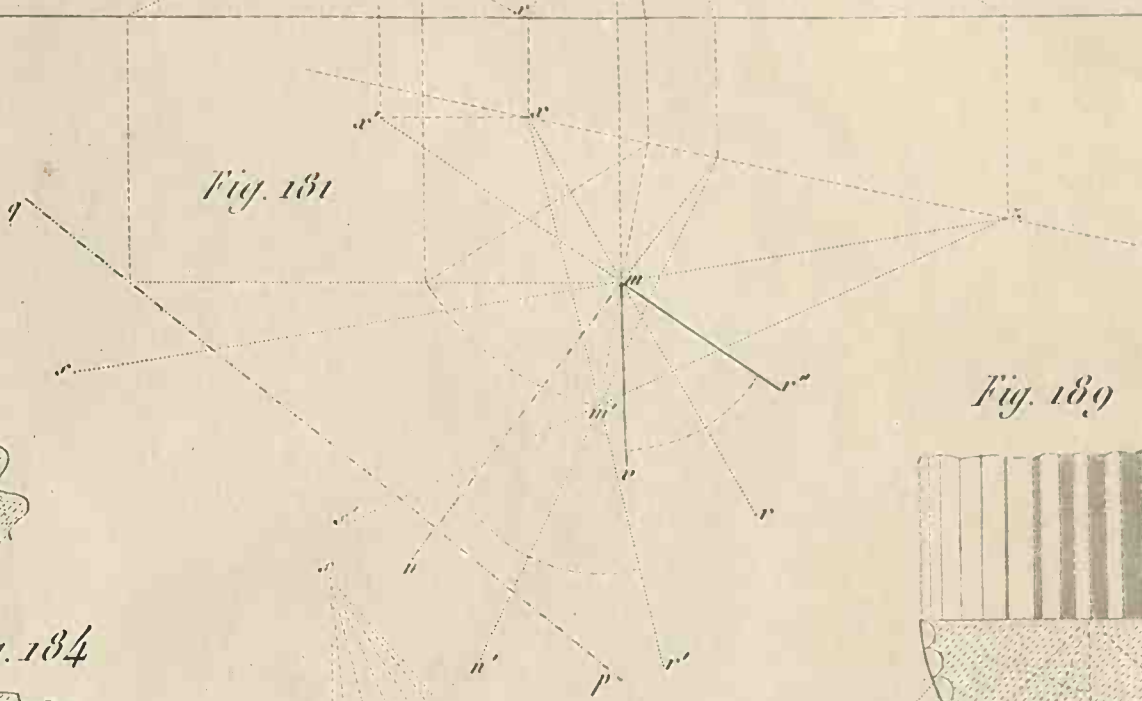

Fig. 189

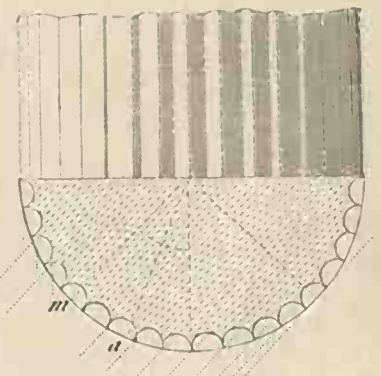

Fig. 184

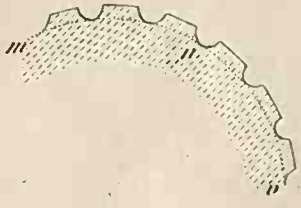

Fig. 187

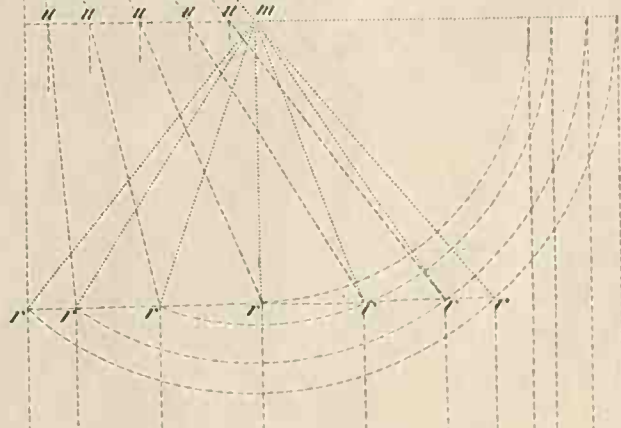

Fig. 185

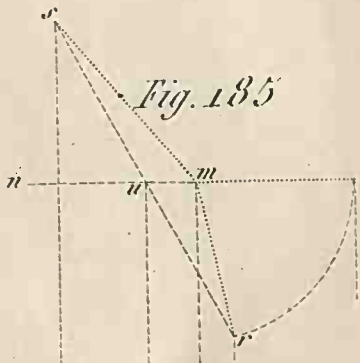

Fig. 190

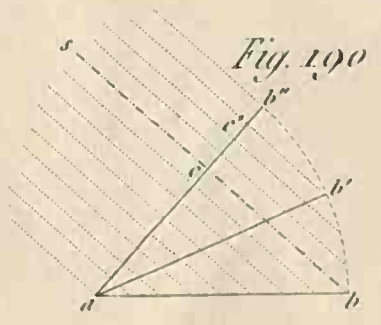

Fig. 186

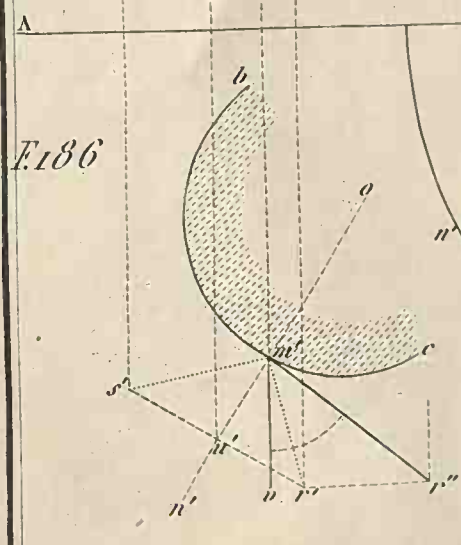

Fig. 188

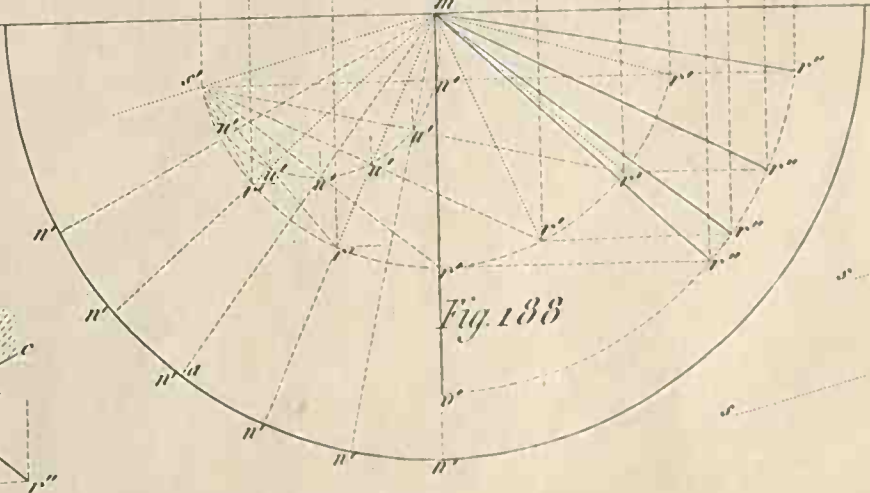
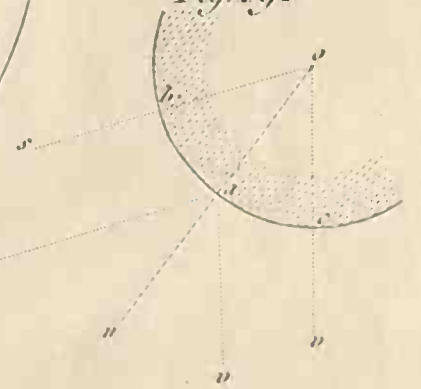

Fig. 191



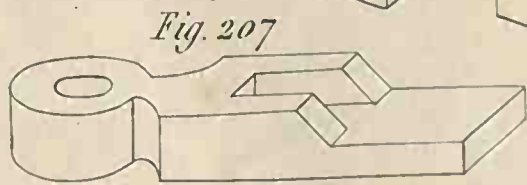
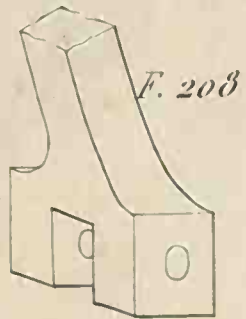
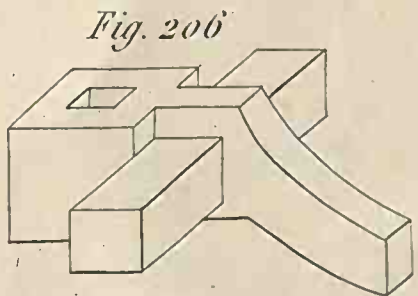
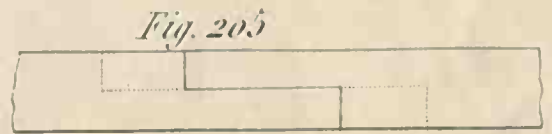
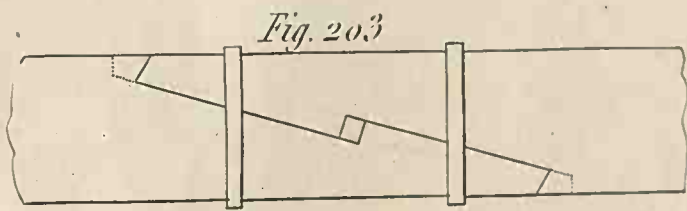
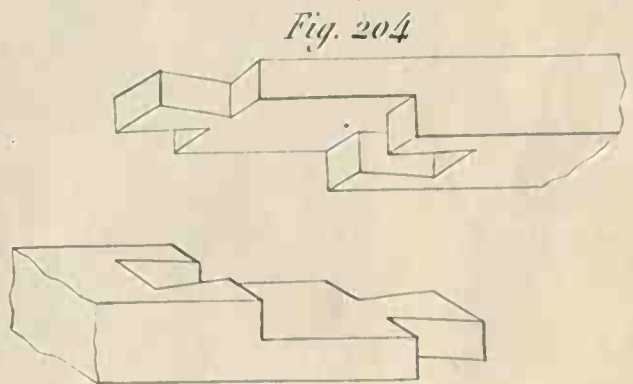
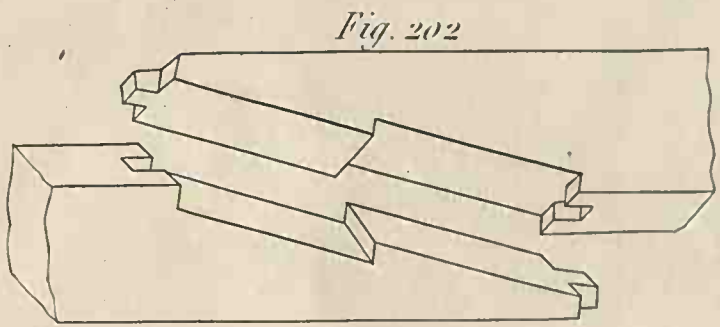
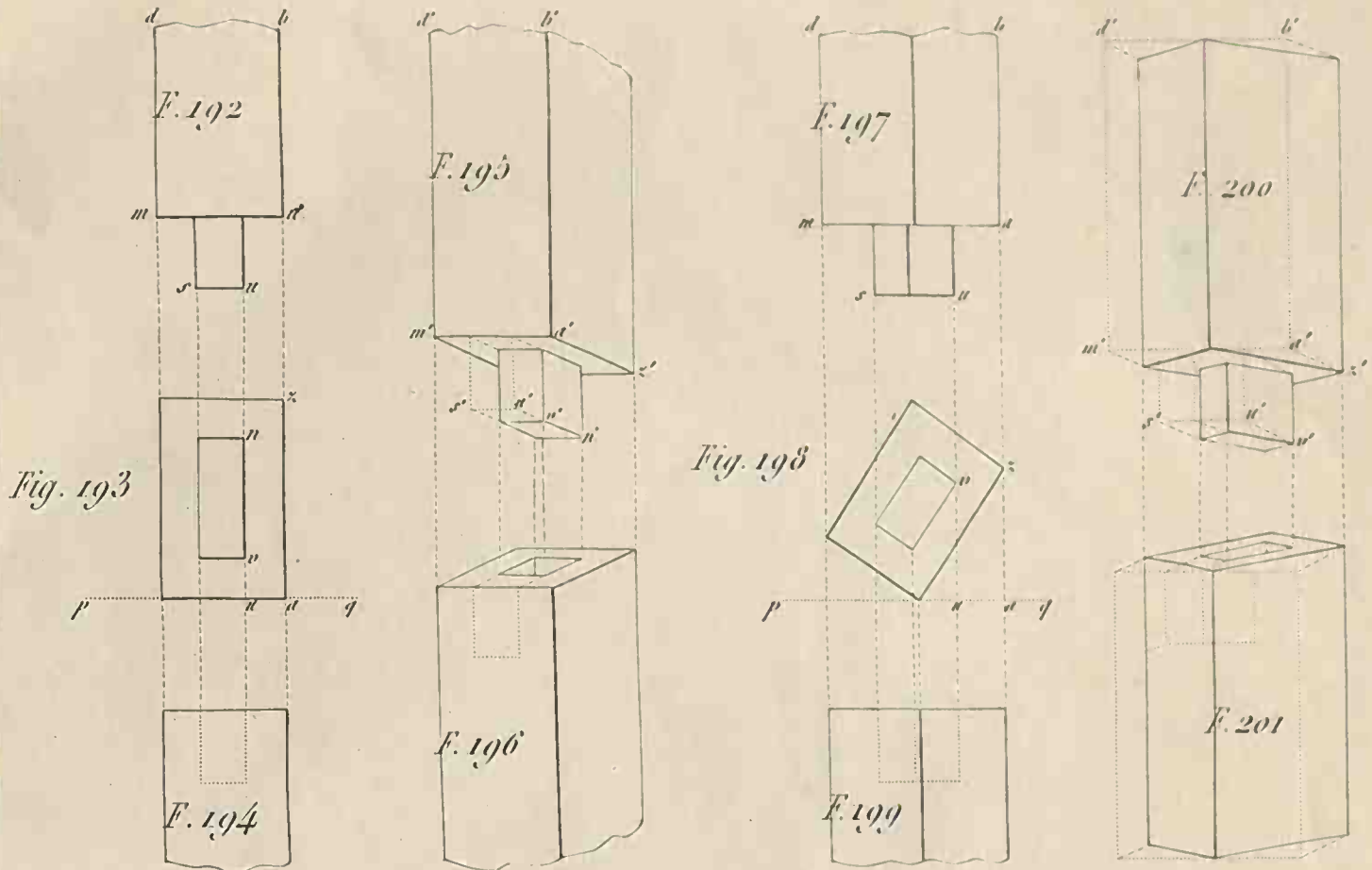

Fig. 211

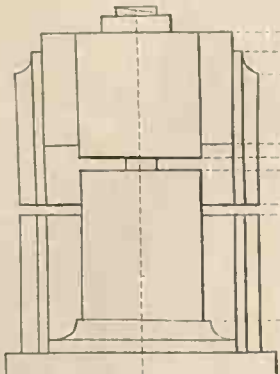

Fig. 212

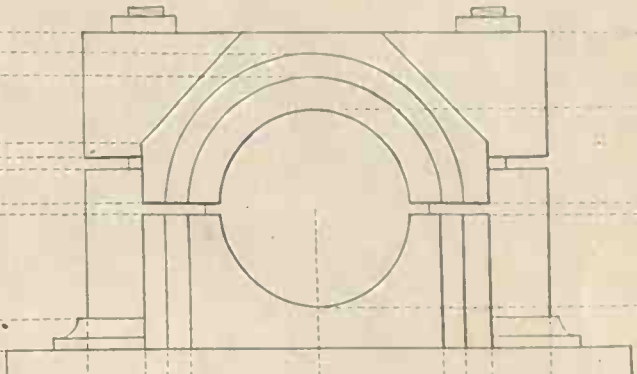

Fig. 213

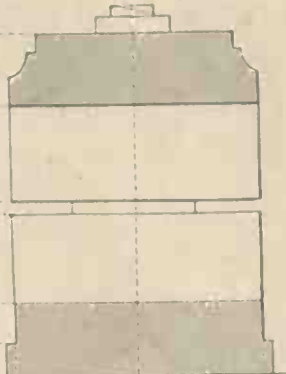

Fig. 214

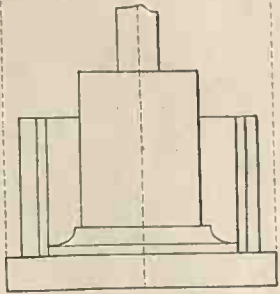

Fig. 215

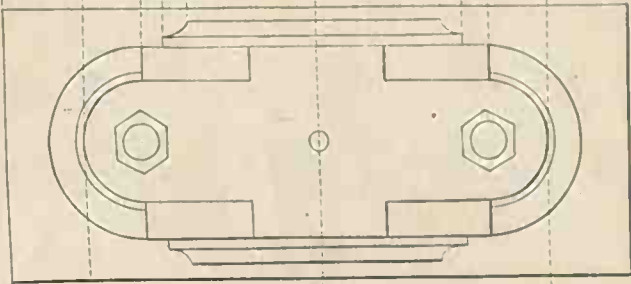

Fig. 216

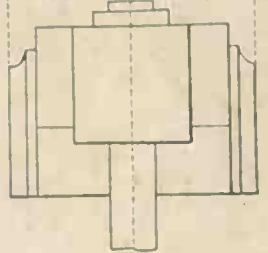

Fig. 217

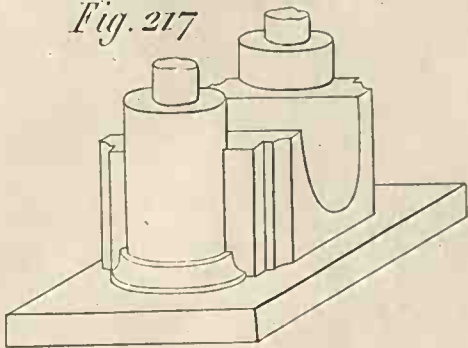

Fig. 218

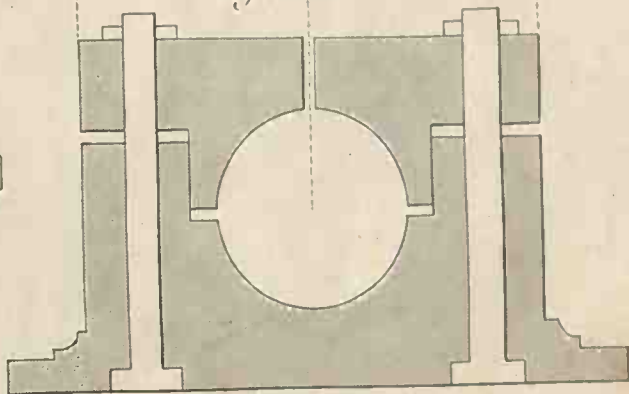

Fig. 219

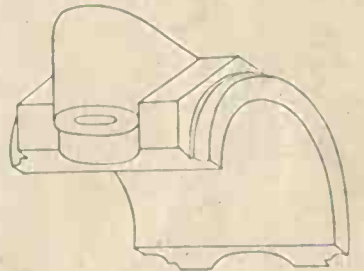

Fig. 220

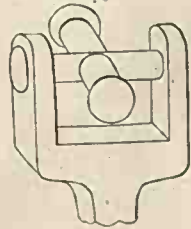

Fig. 221



Fig. 223

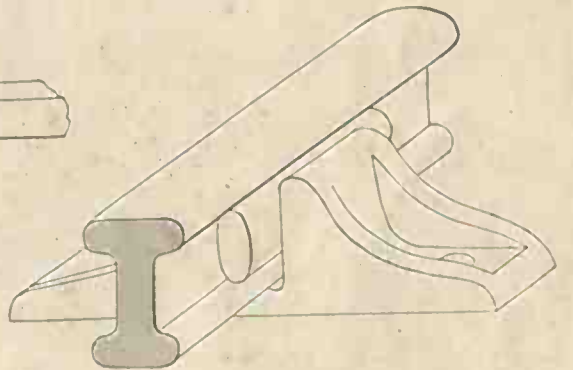

Fig. 222

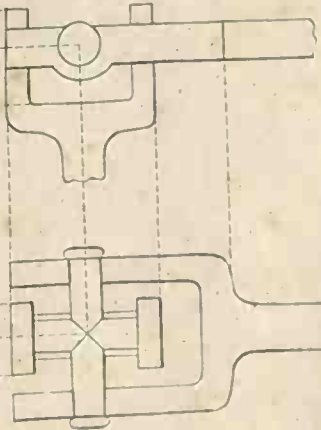
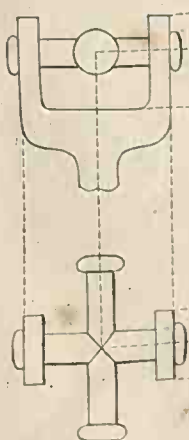
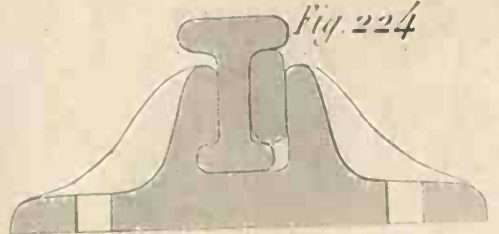

Fig. 224



Perspective cavalière

Fig. 1.

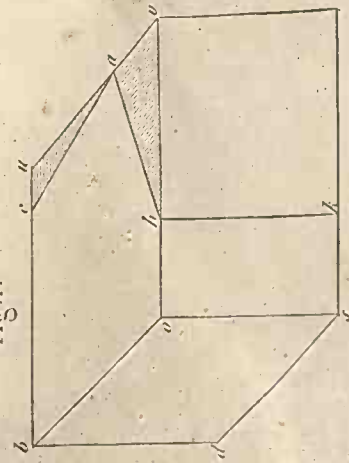

Fig. 2.

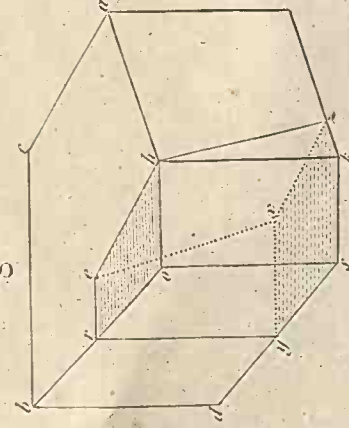

Fig. 3.

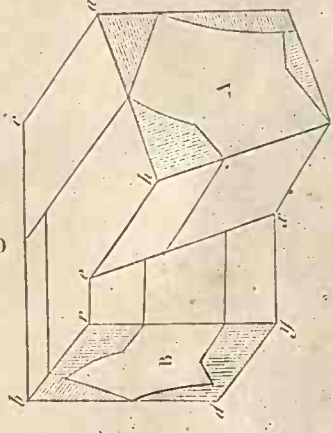

Fig. 4.

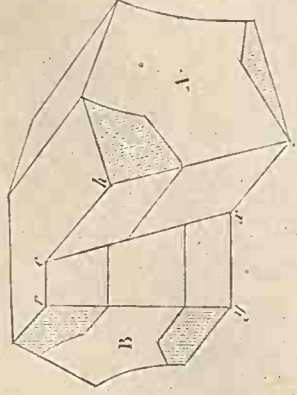

Fig. 5.

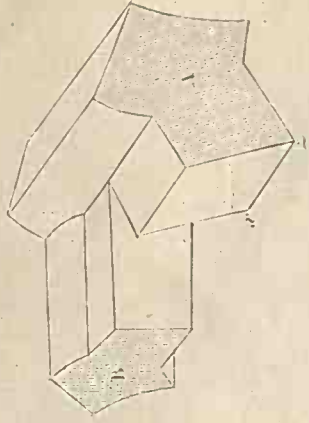

Fig. 6.



Fig. 7.

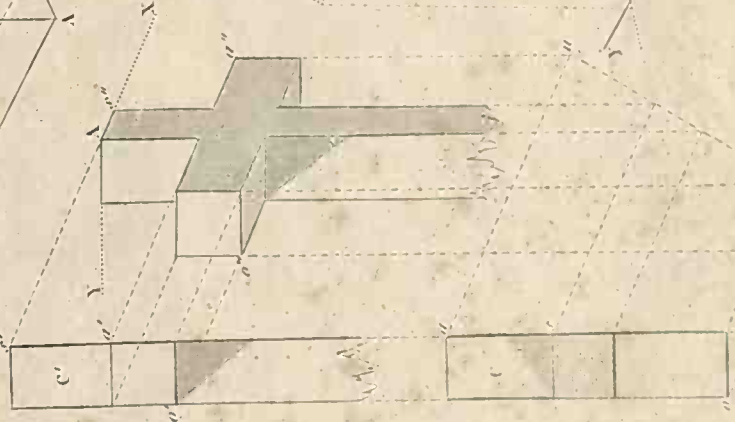

Fig. 8.

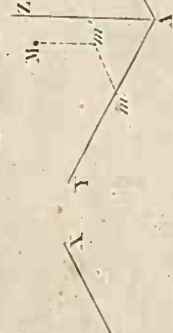

Fig. 9.

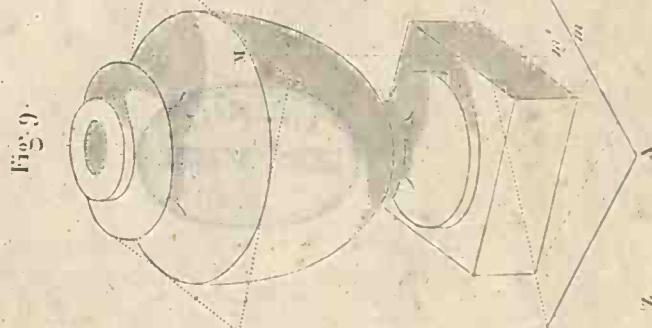

Fig. 9.

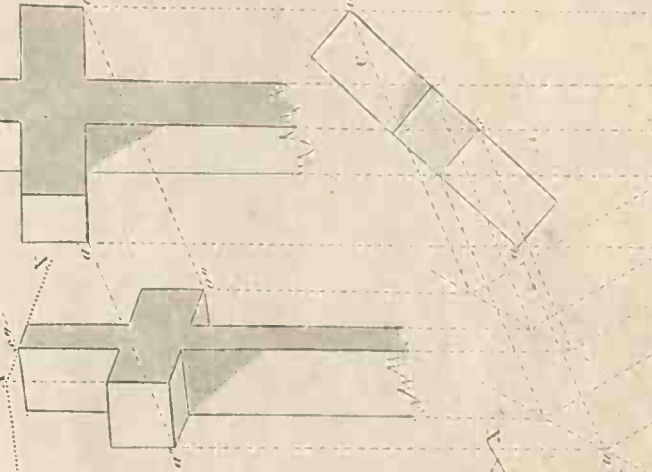

Fig. 10.

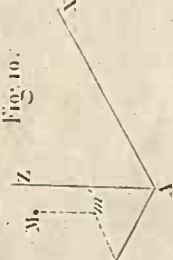

Fig. 11.

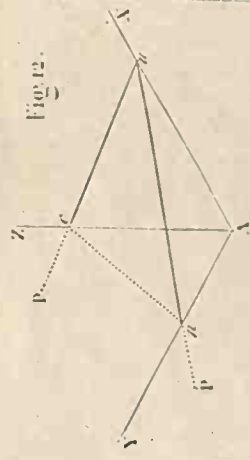

Fig. 12.

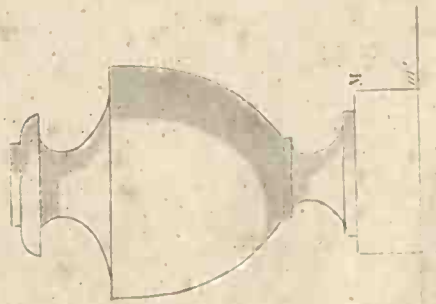

Fig. 13.

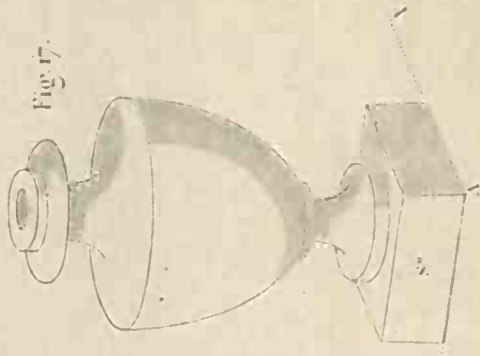

Fig. 14.



Fig. 15.

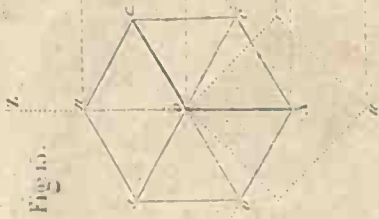

Fig. 16.

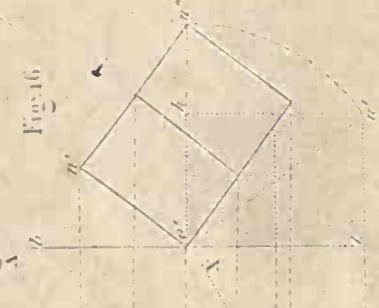
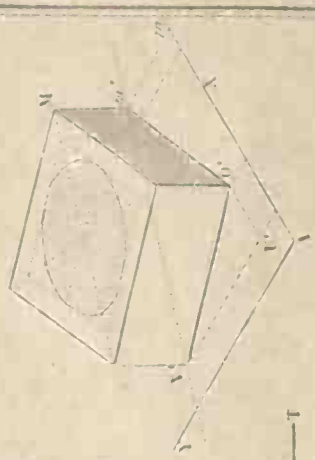

Fig. 17.



VERIFKAT 1937

