

W. 18649

COURS

DE

MATHÉMATIQUES

A L'USAGE

DES ARCHITECTES, INGÉNIEURS CIVILS, ETC.

328239

PAR J. ADHÉMAR



Tom. 4

~~~~~  
GÉOMÉTRIE DESCRIPTIVE  
~~~~~

515 (254)

24553

Cinquième édition.

PARIS

ARMAND COLIN ET C^{IE}, ÉDITEURS

16, RUE DE CONDÉ, 16

—
1875

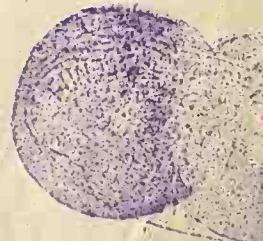

4/953

BIBLIOTECA DE LA UNIVERSITATEA
BUCURESTI
Cota.....18651
Inventar.....24553

1951

1956

L

RC 115/06

B.C.U. Bucuresti

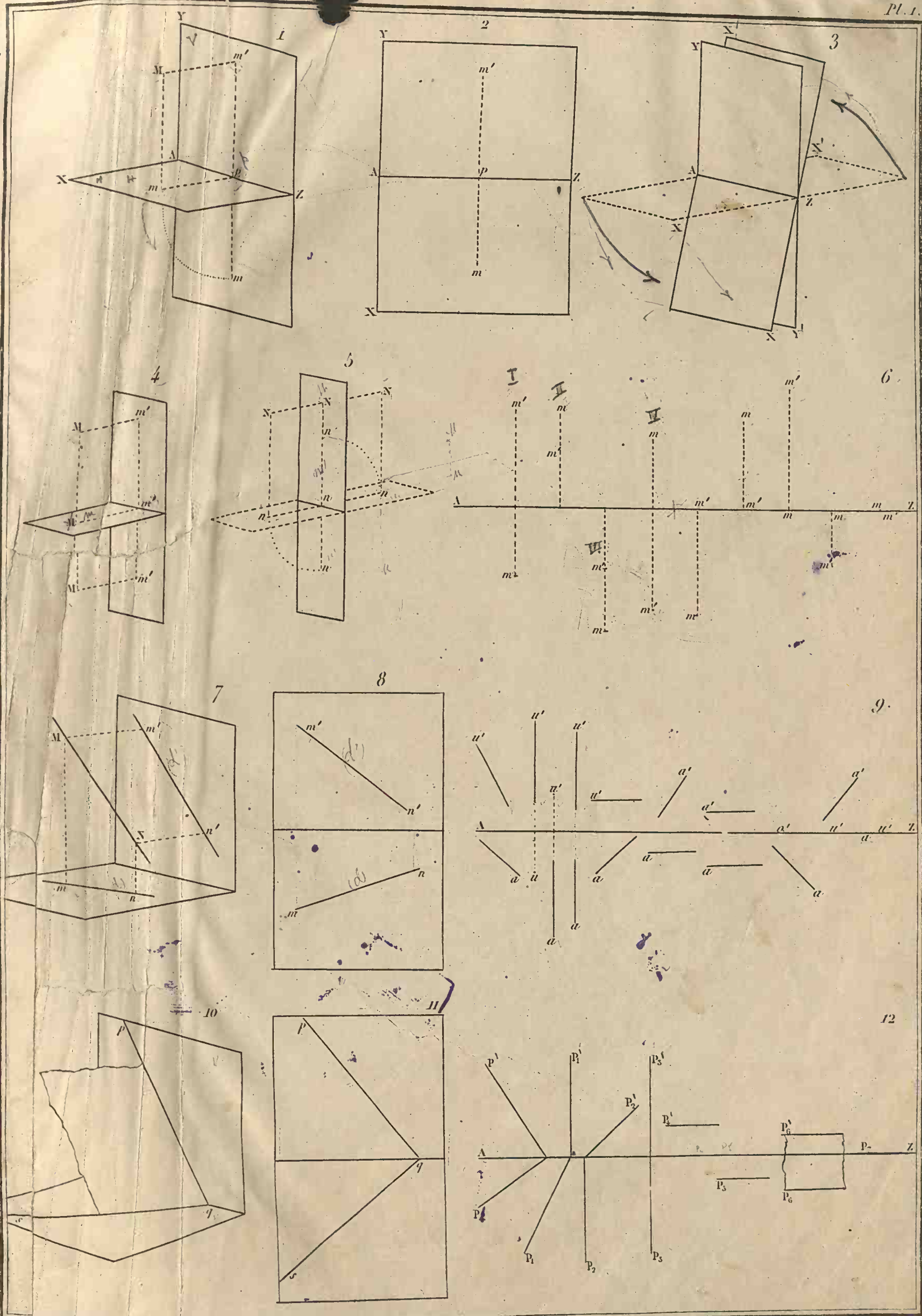
C24553

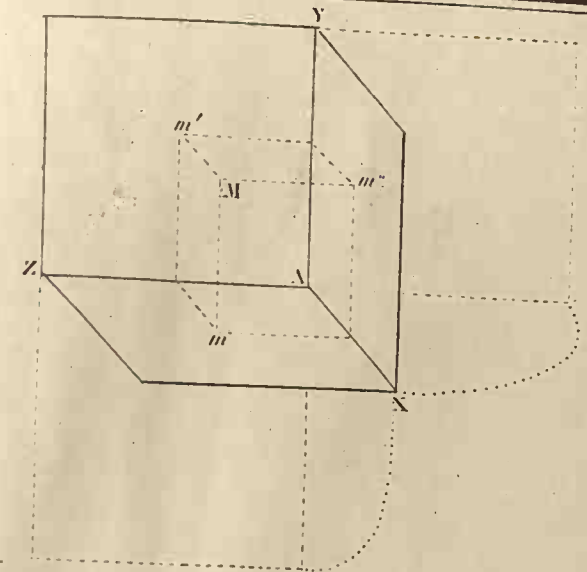

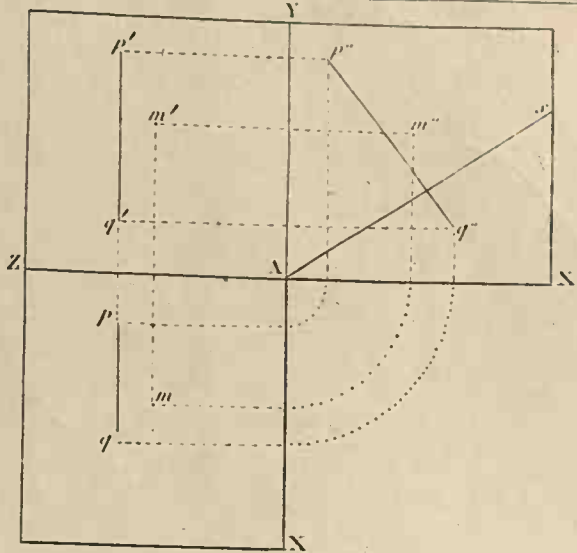

13.



14.

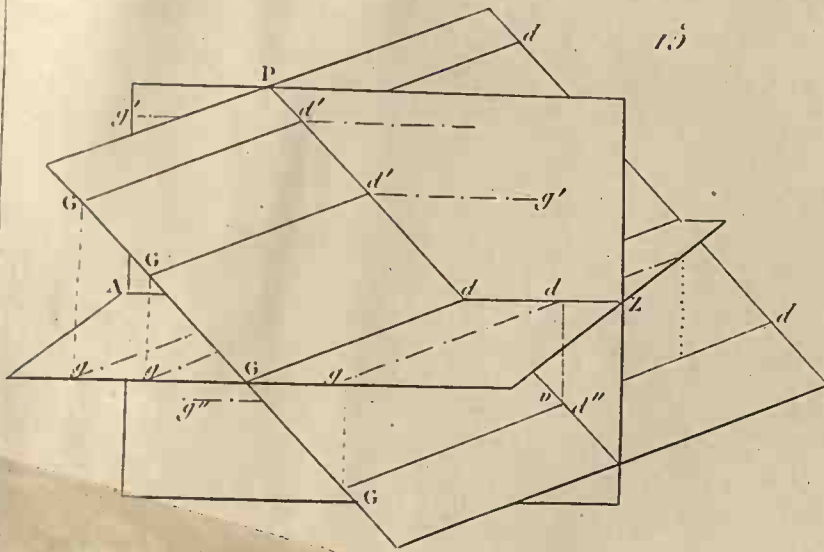

15.

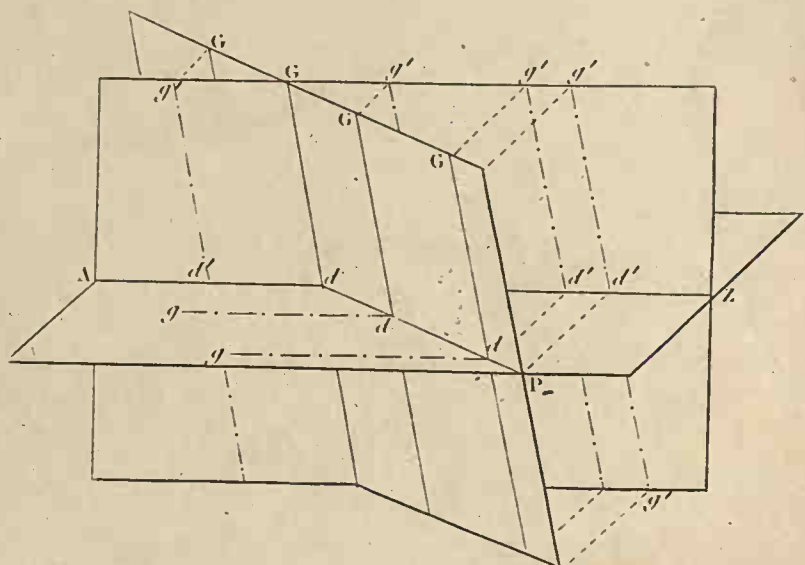

17.

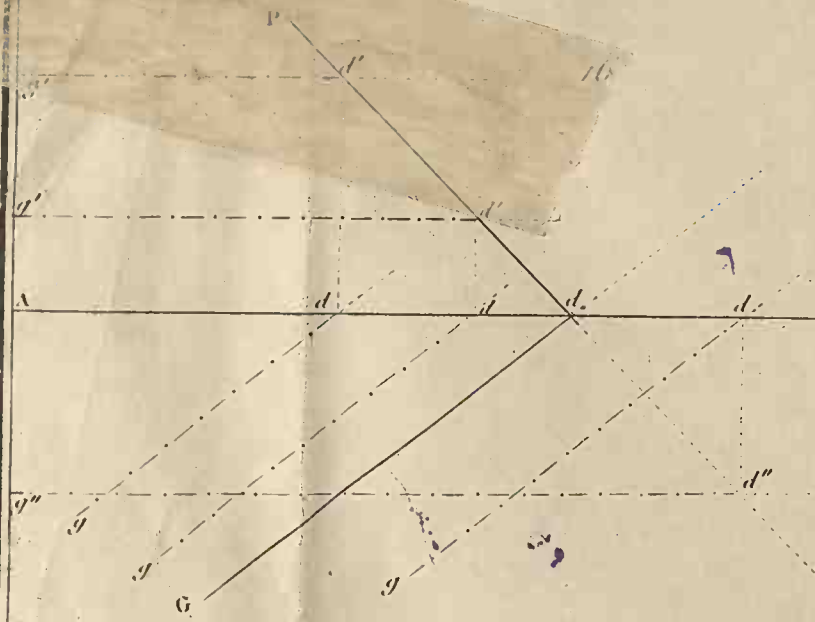

16.

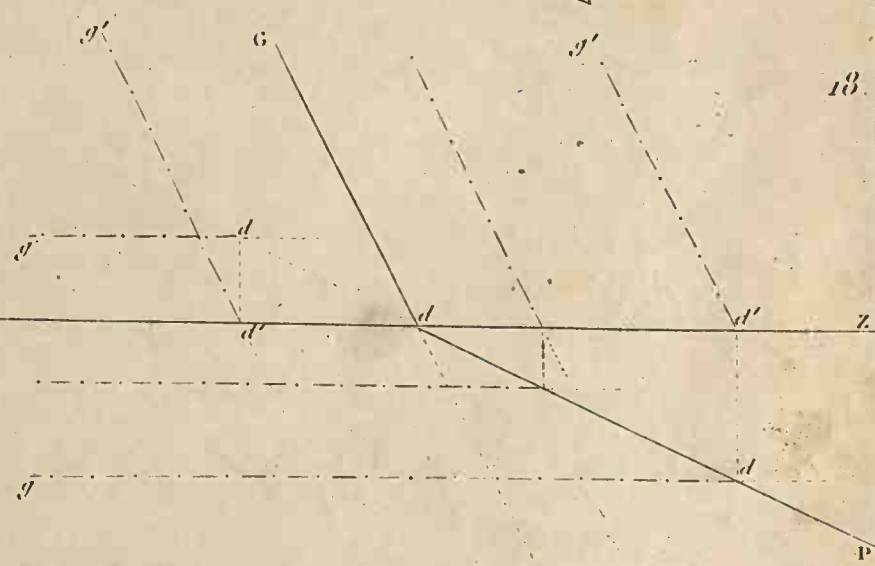

18.

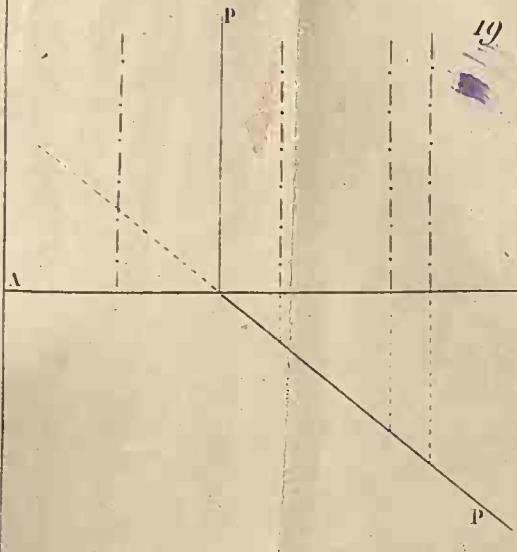

19.

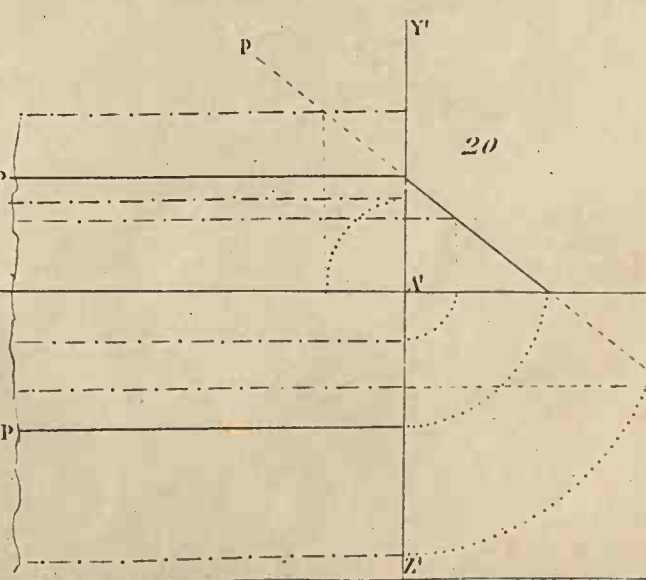

20.

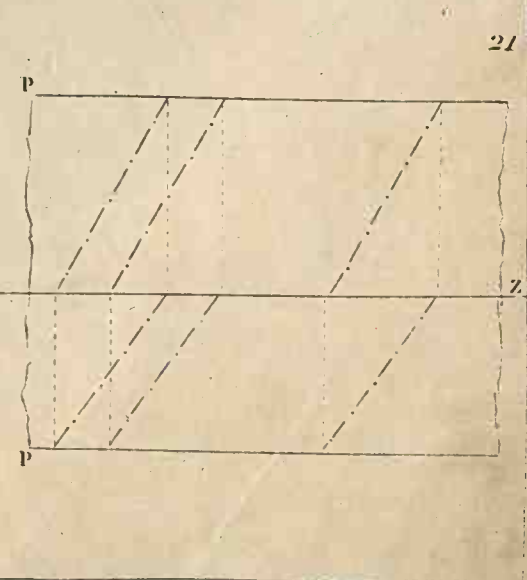

21.

22

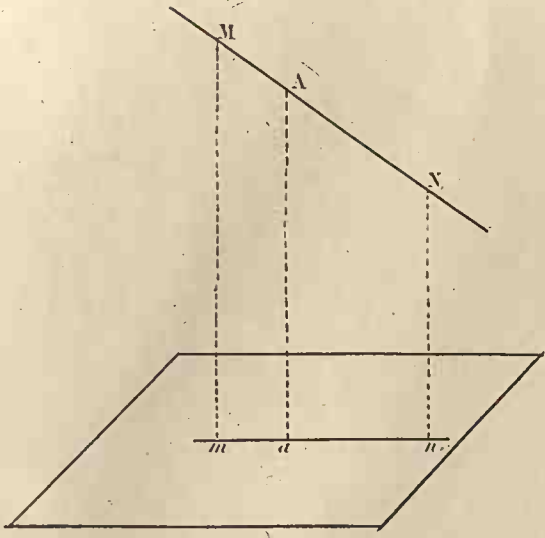

23

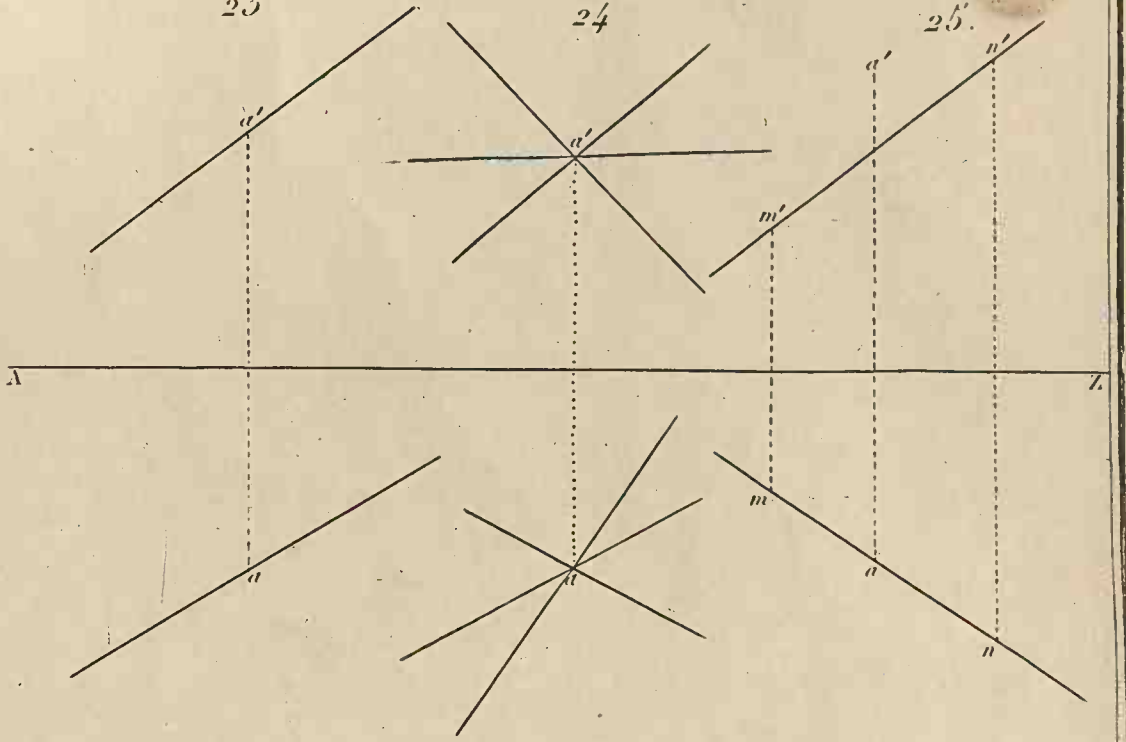

24

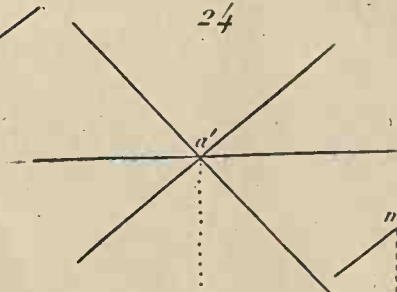

25

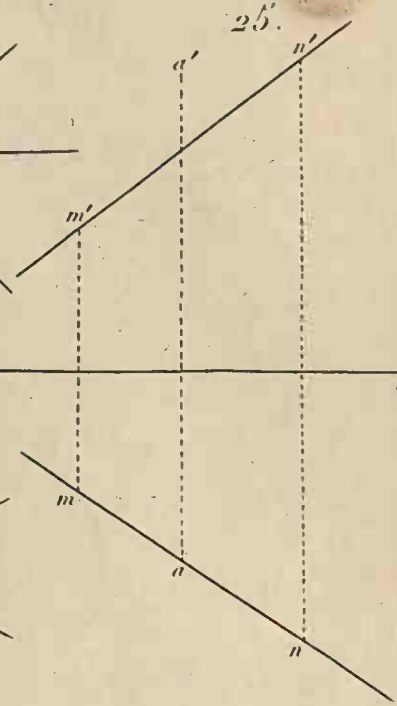

26

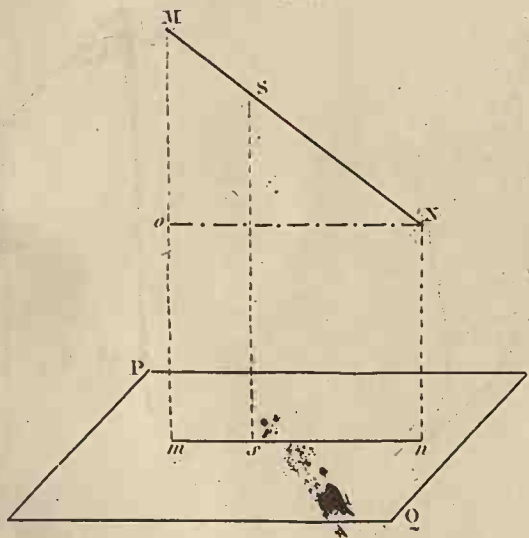

27

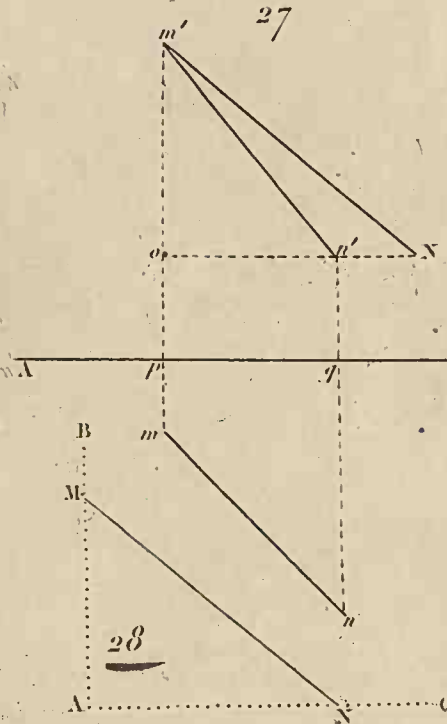

29

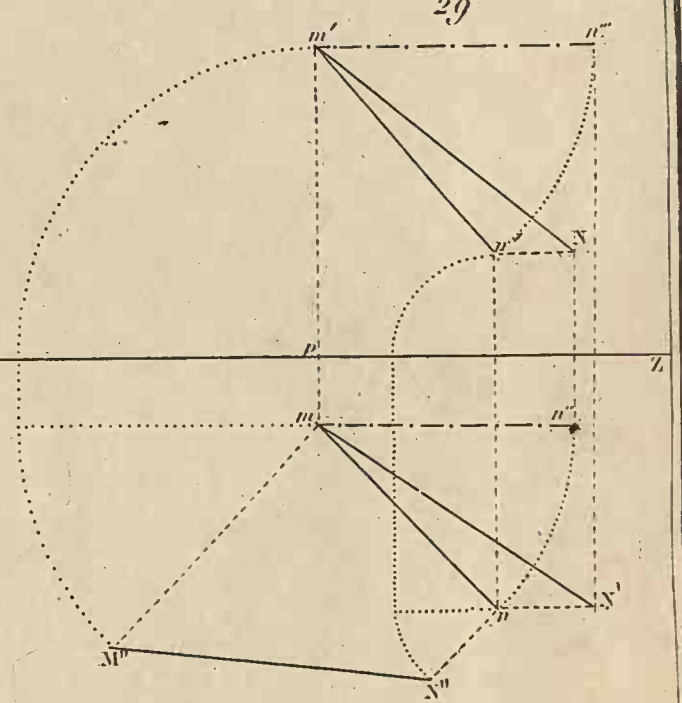

28

30

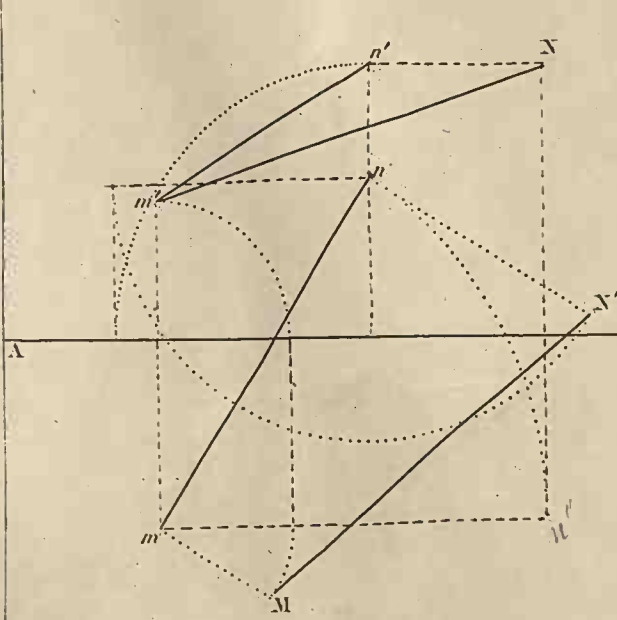

31

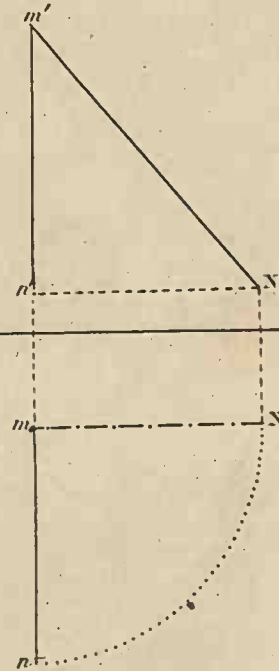

32

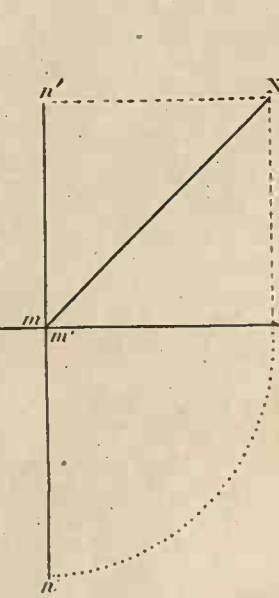

33

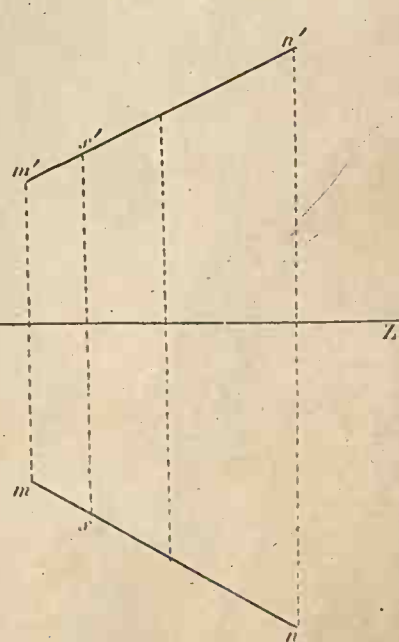

34

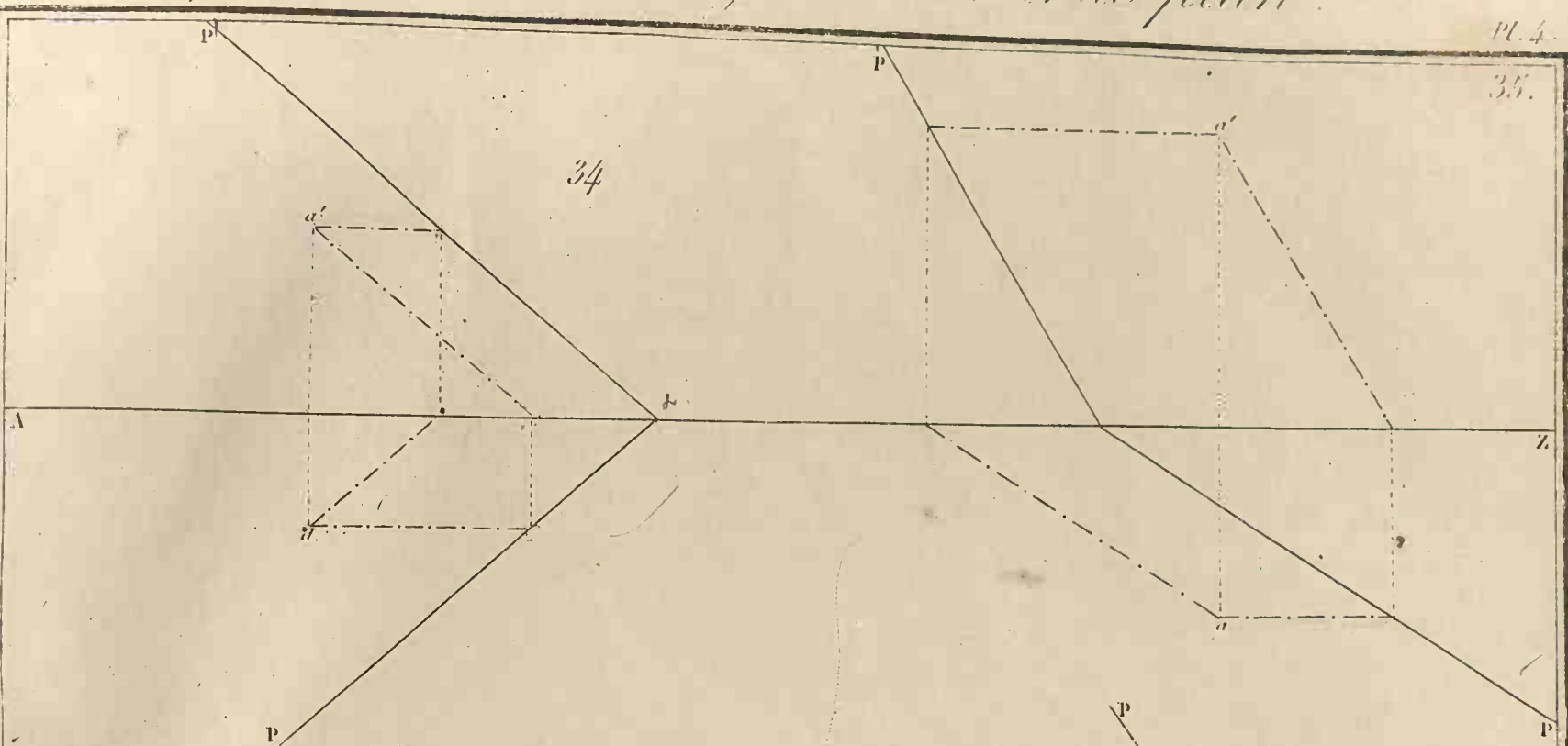

36

37

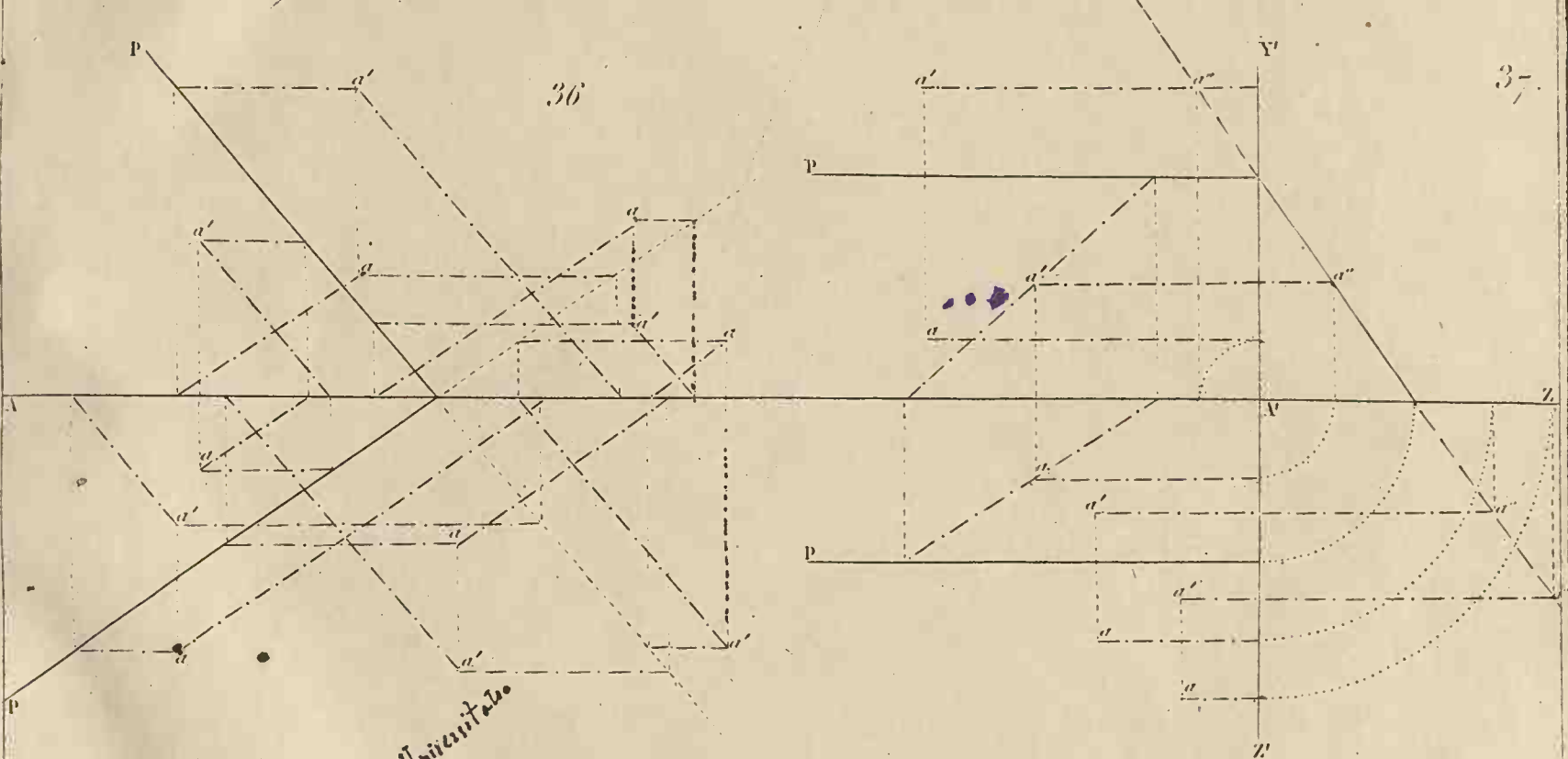

Usité

38

39

40

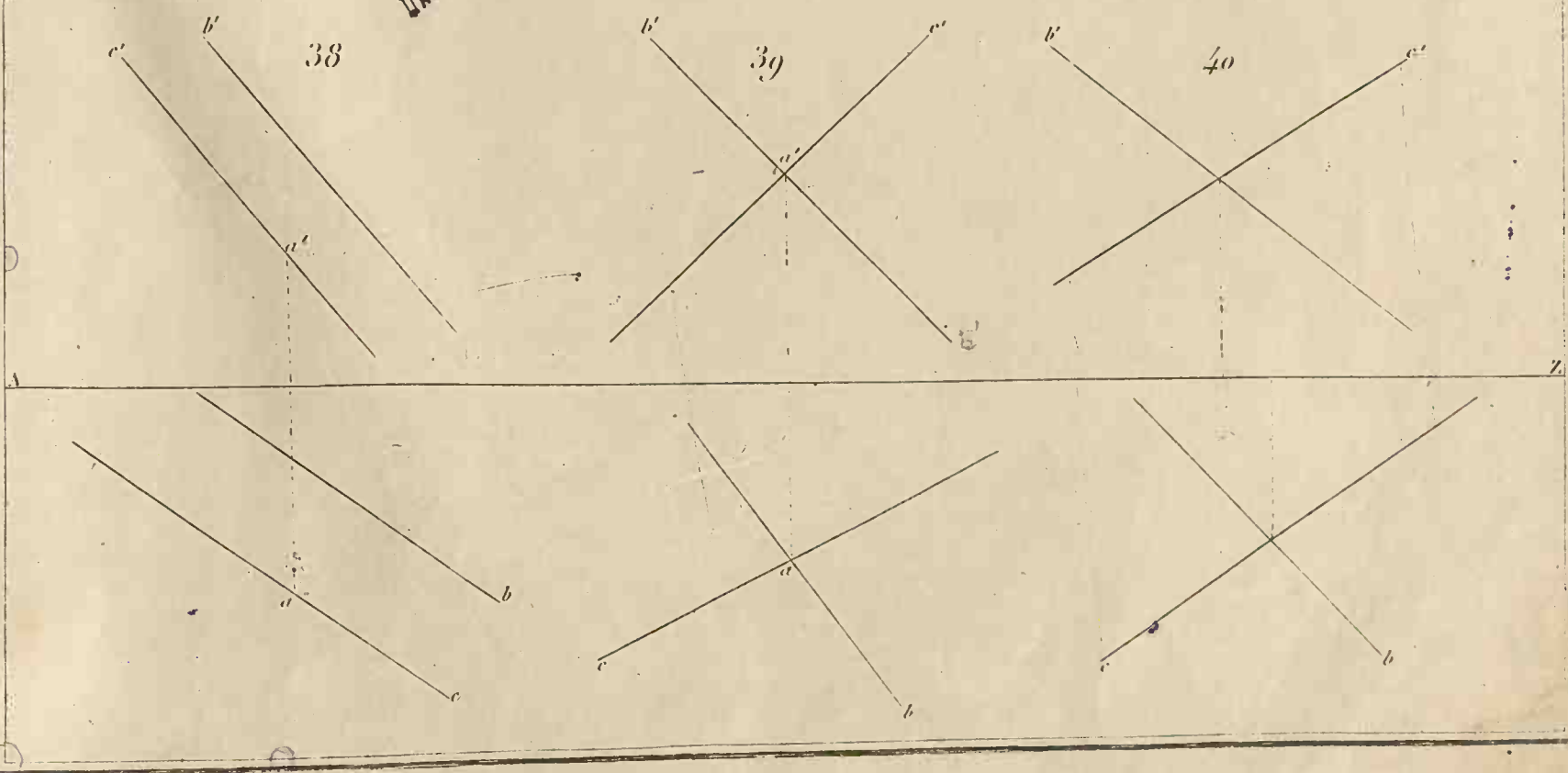

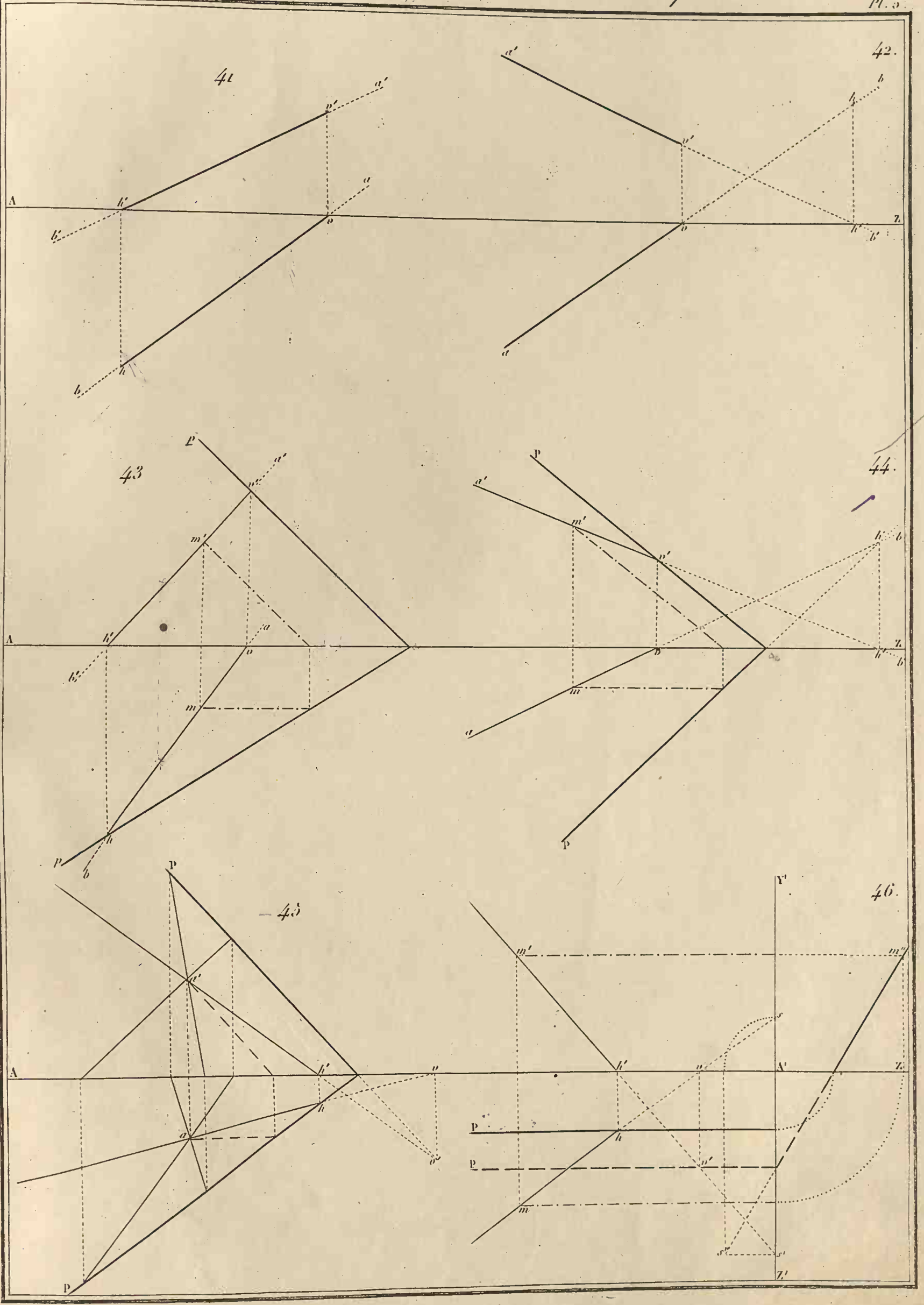

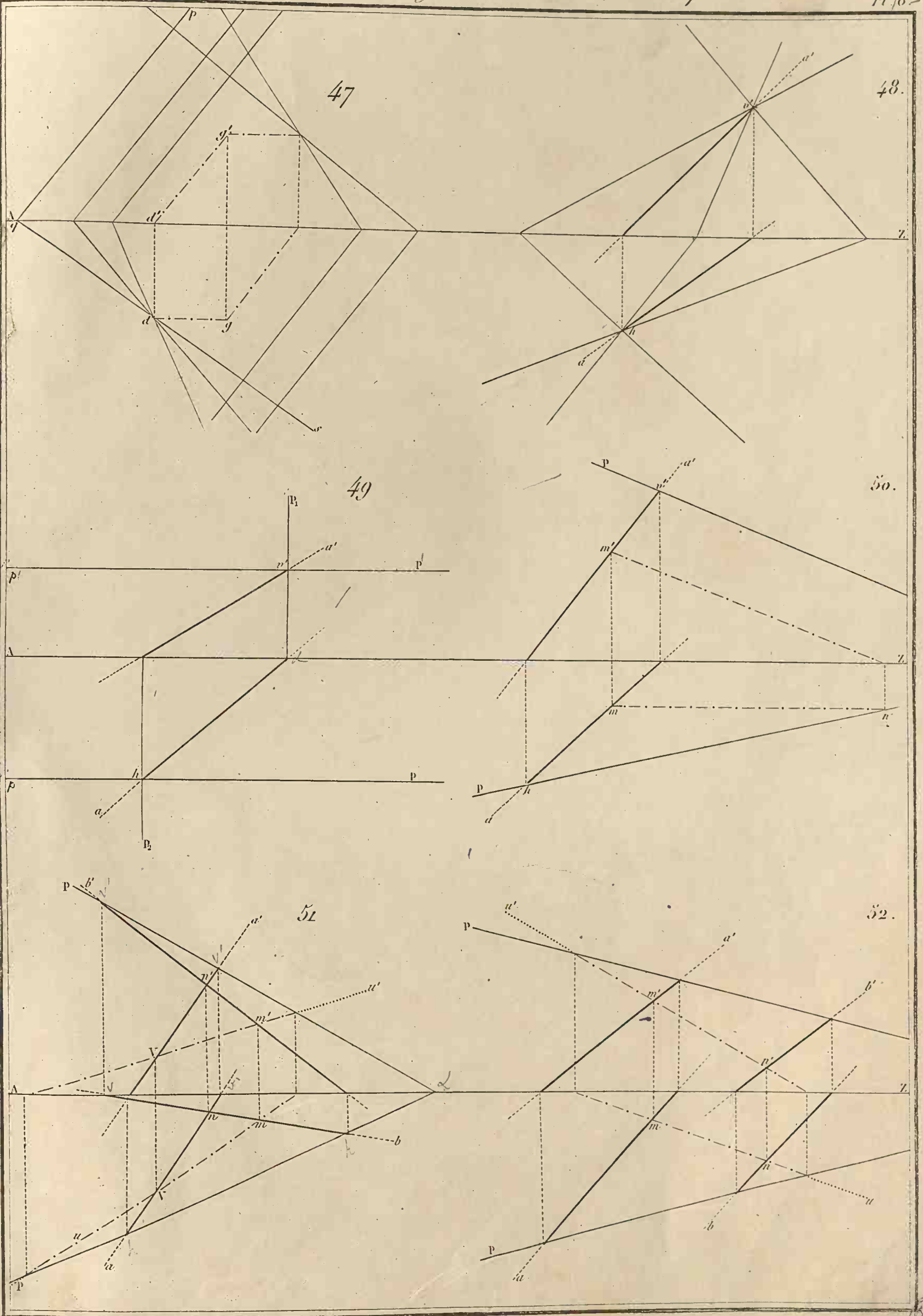

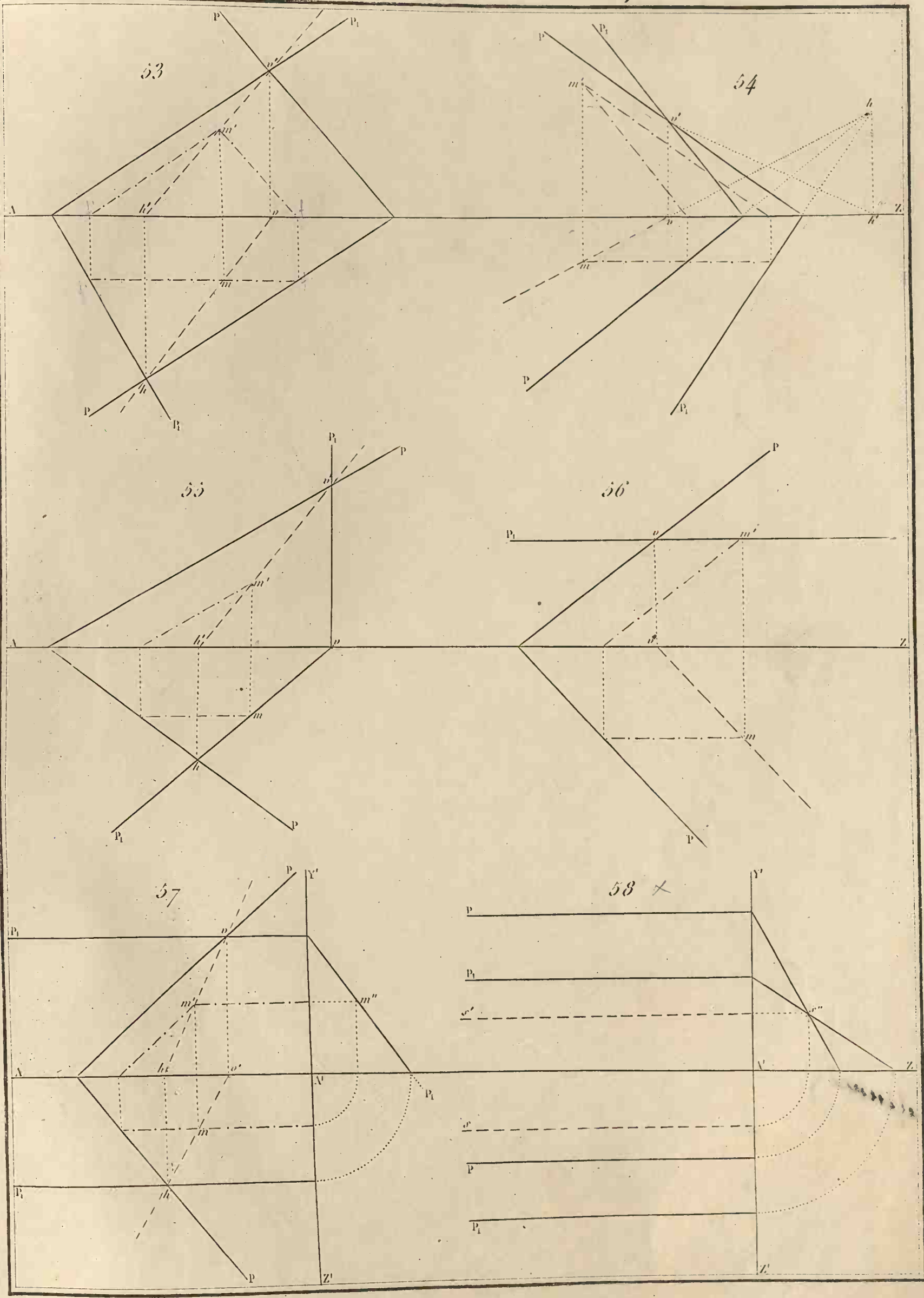

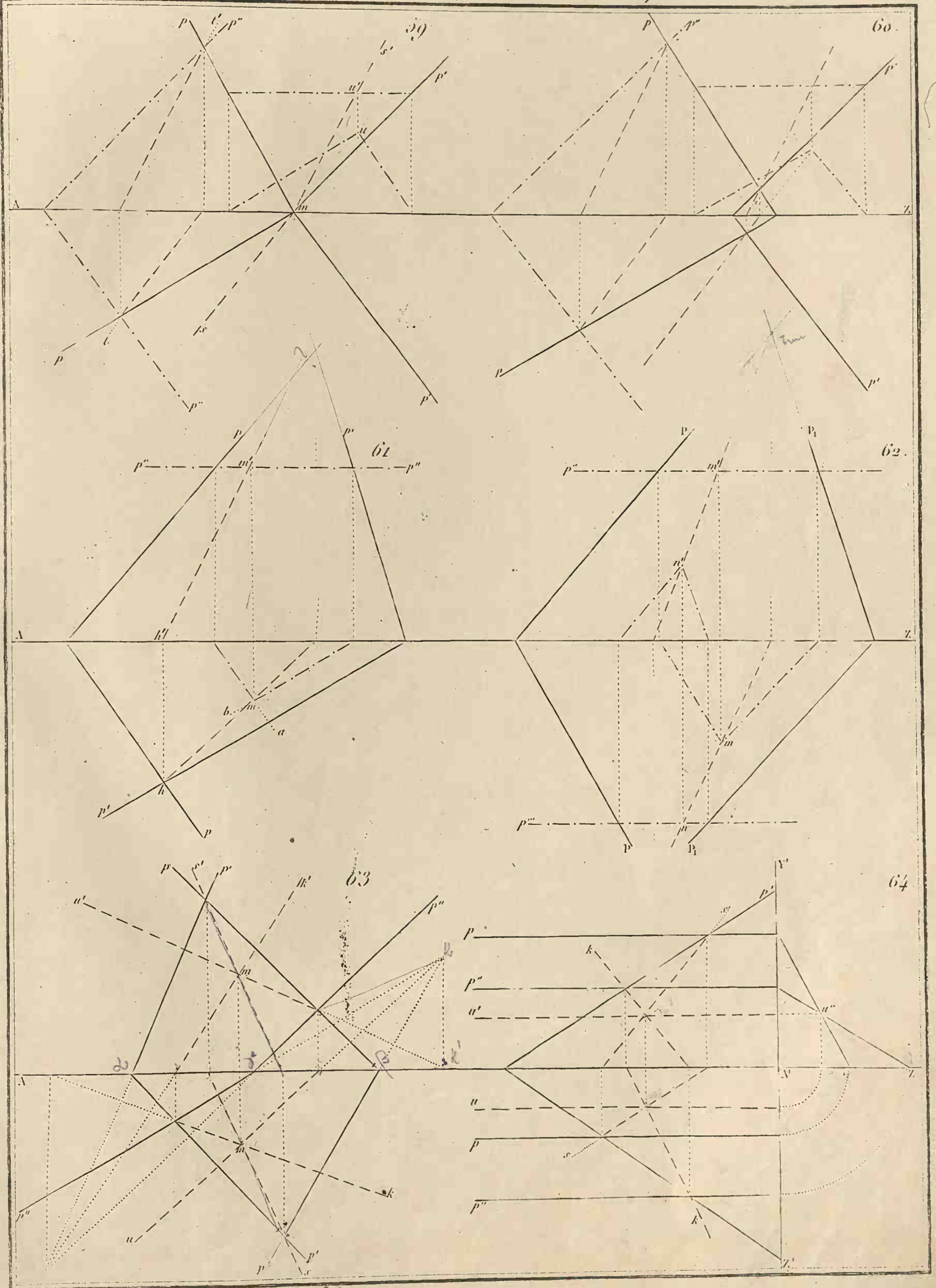

65

66

67

68

69

70

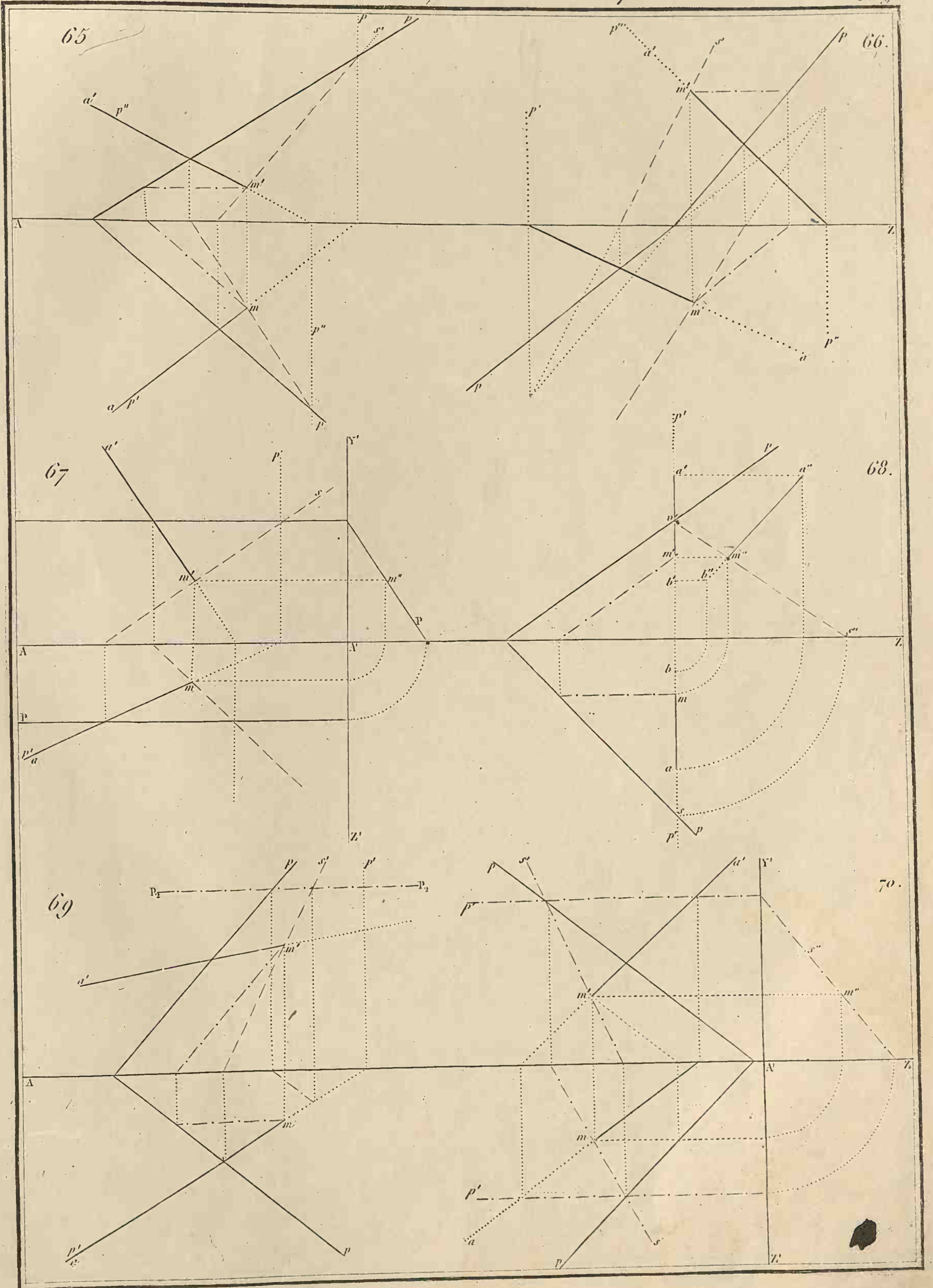

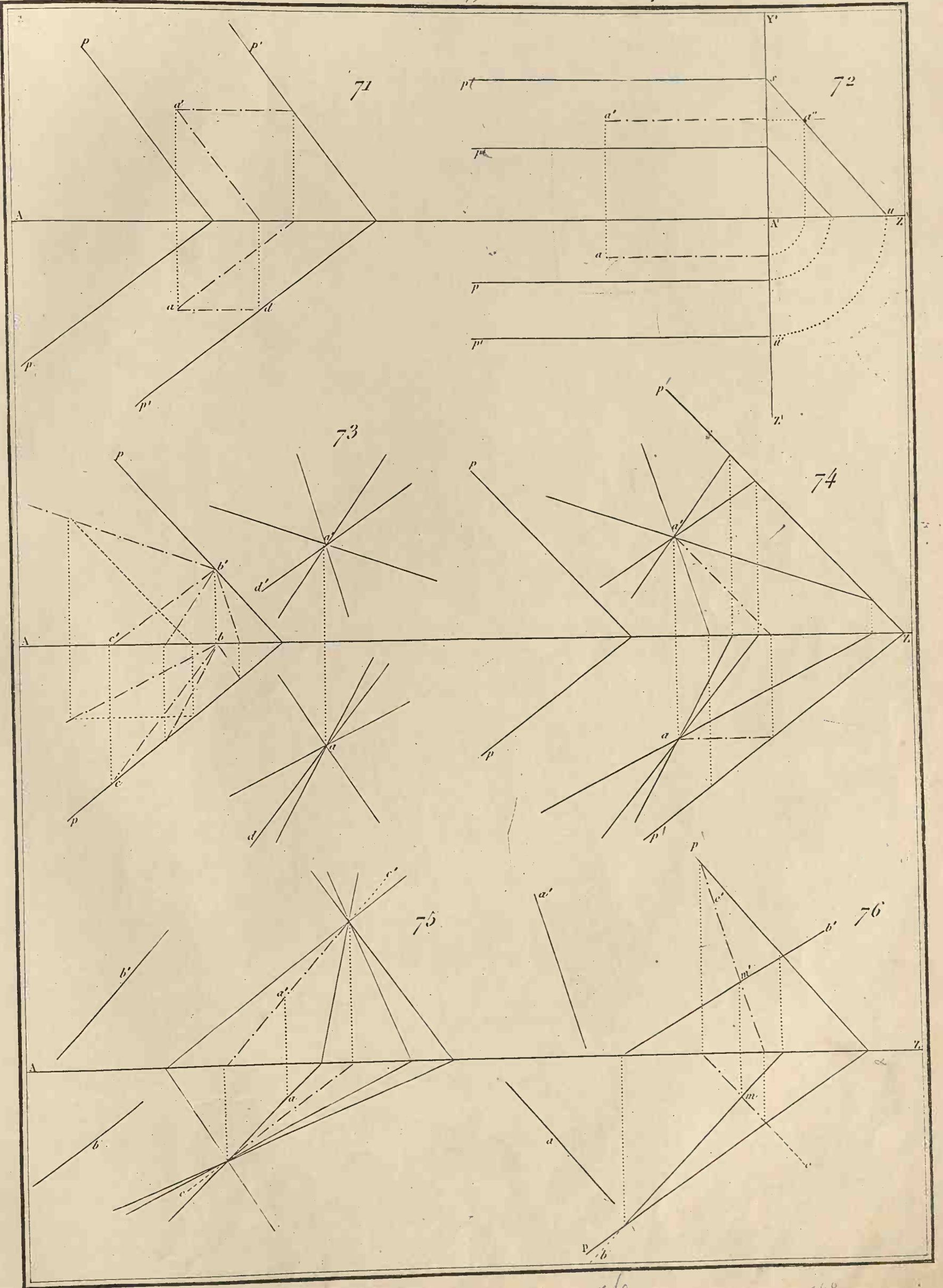

24
150
120

24
140
160

560
240
320

1000
1000

560

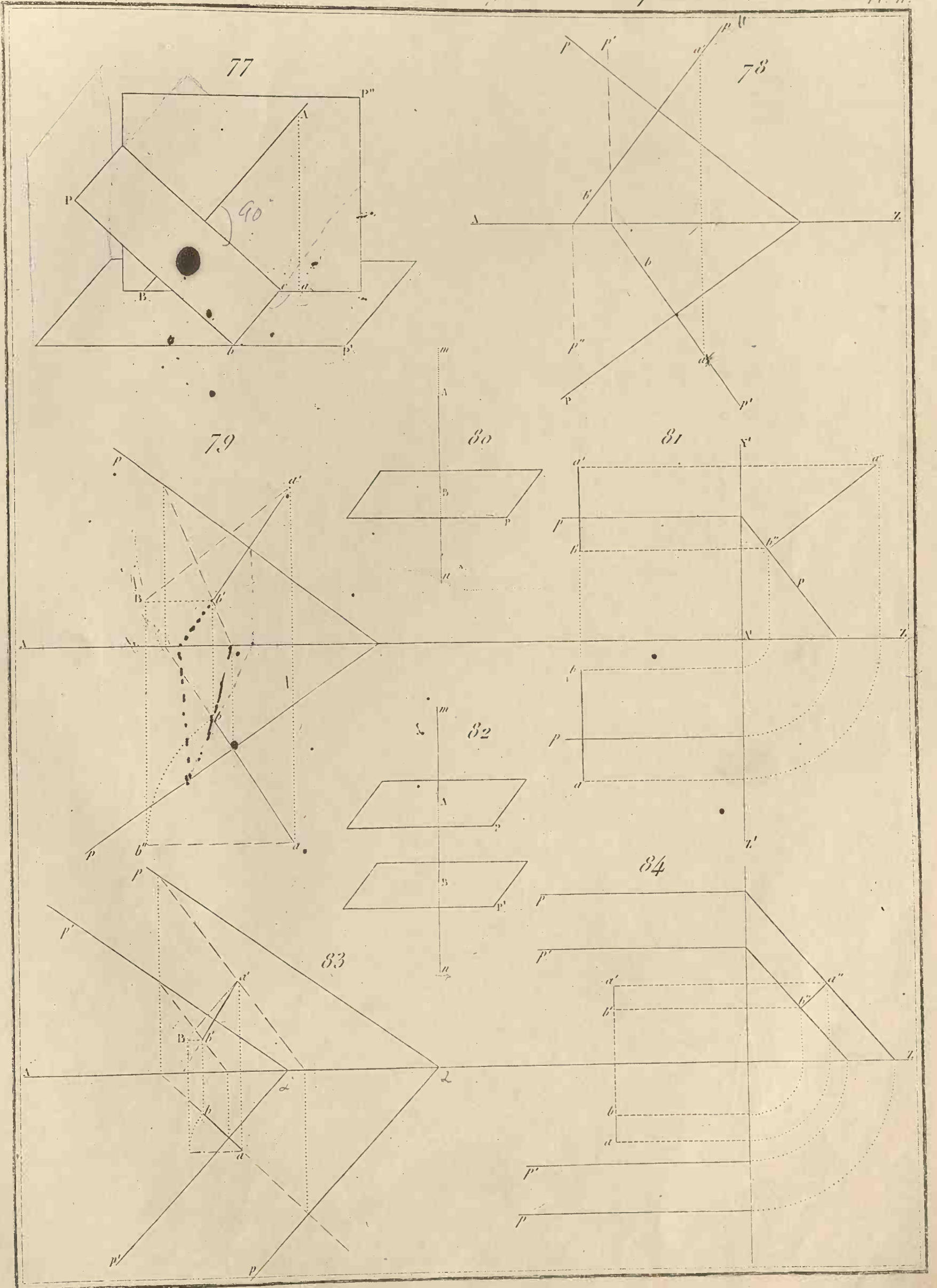

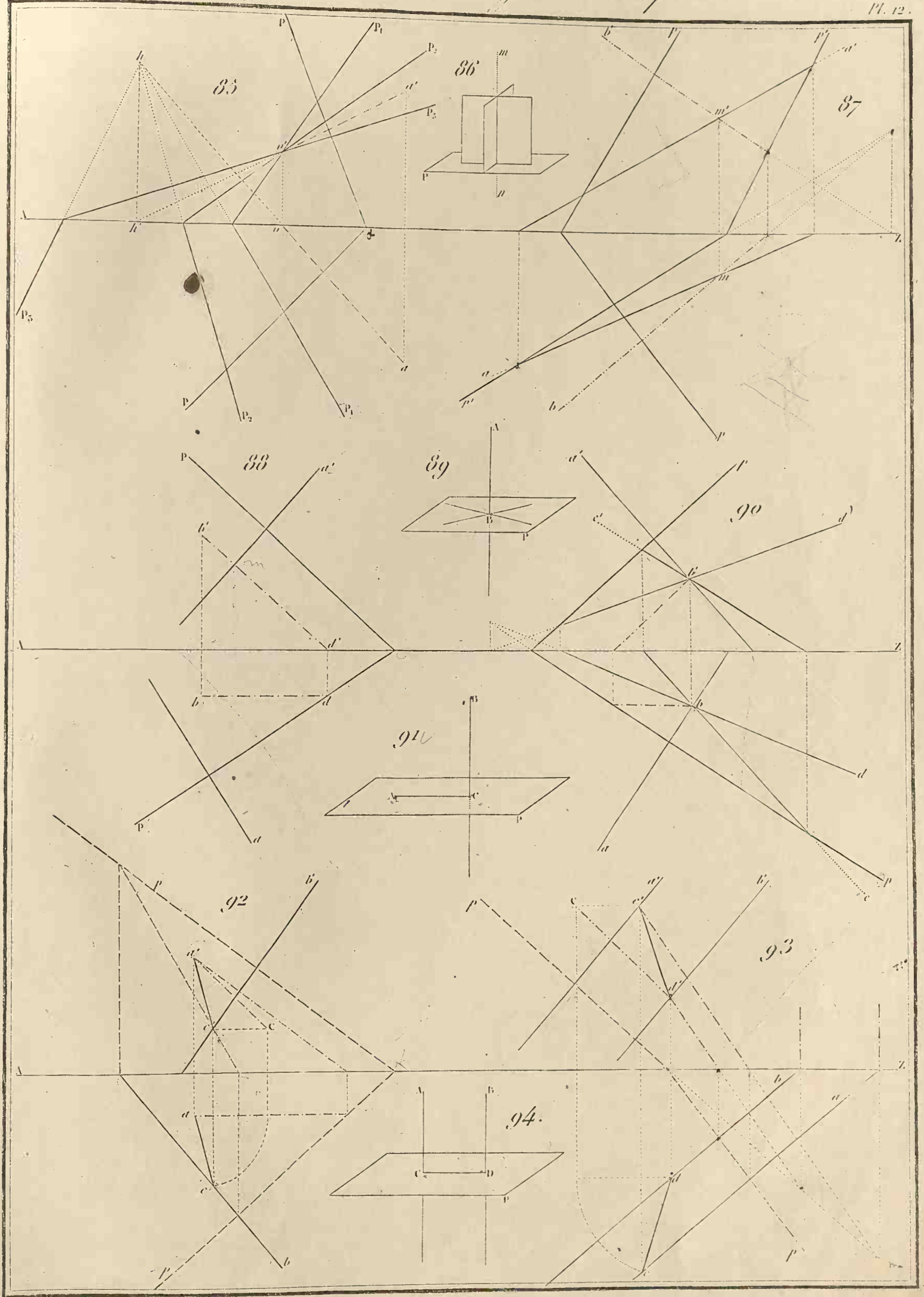

Perpendicularité des lignes et des plans.

Pl. 13

géométrie descriptive.



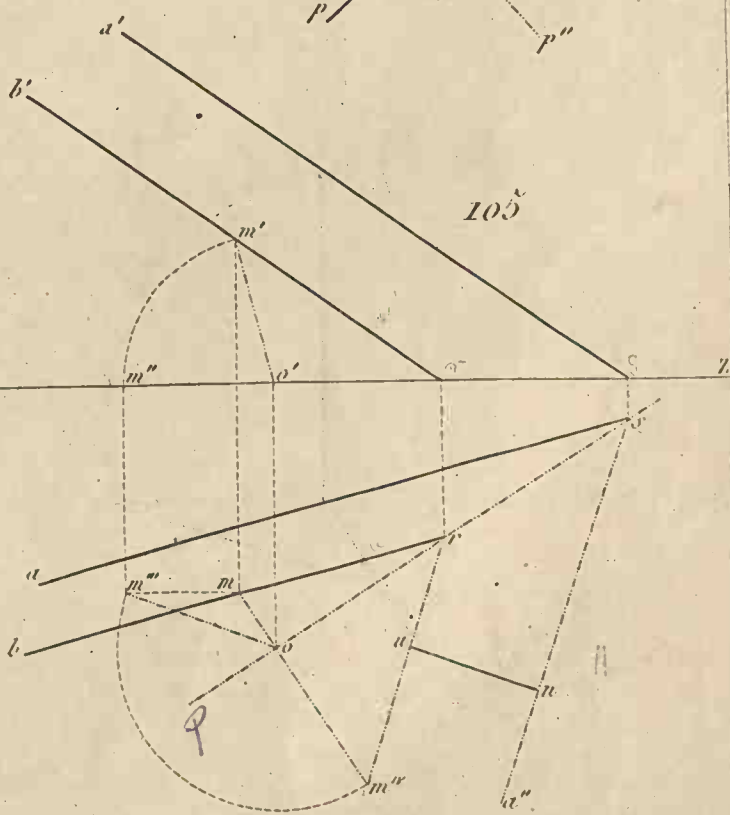
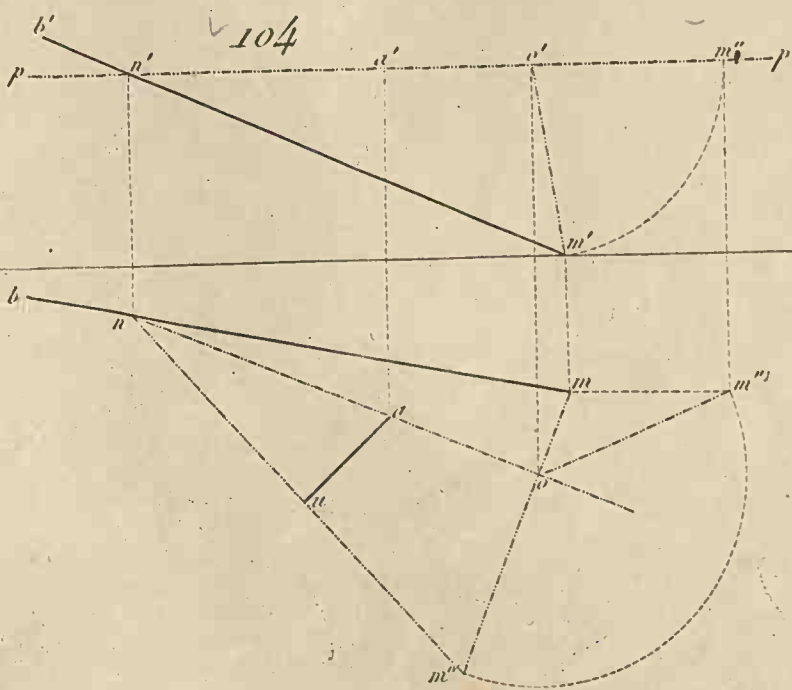
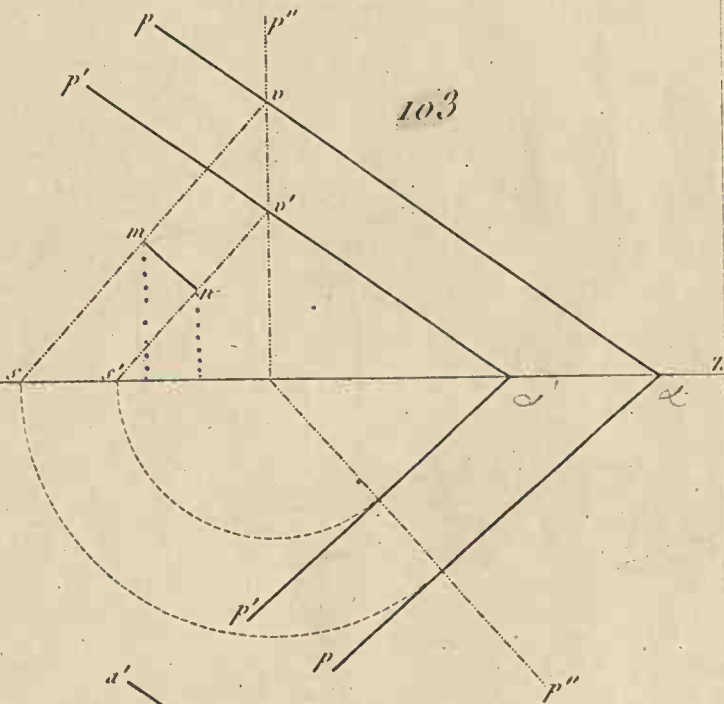
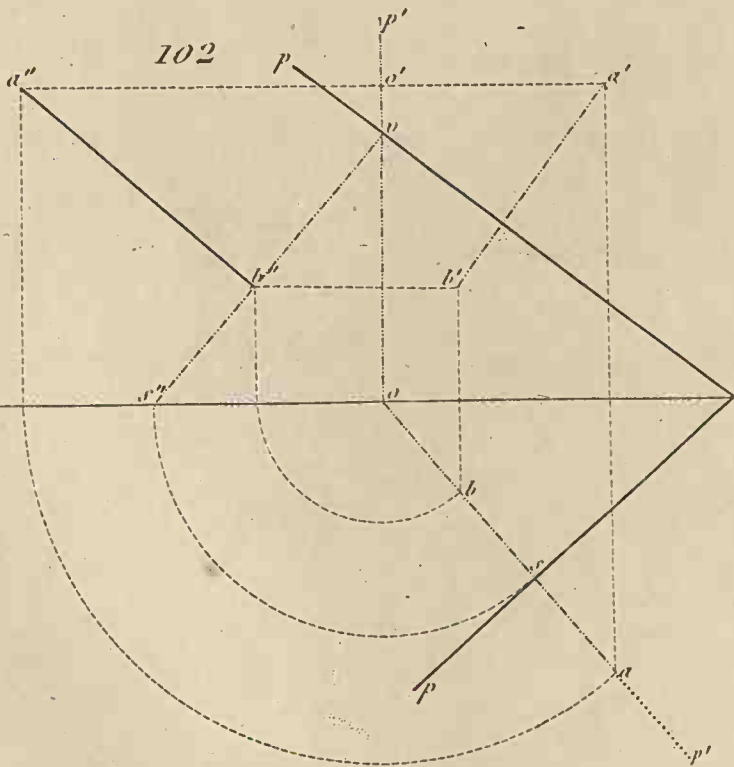
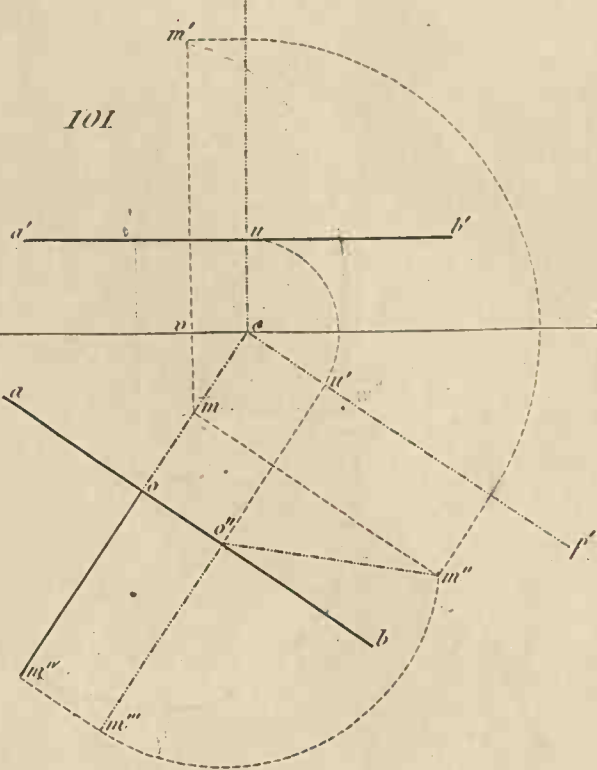
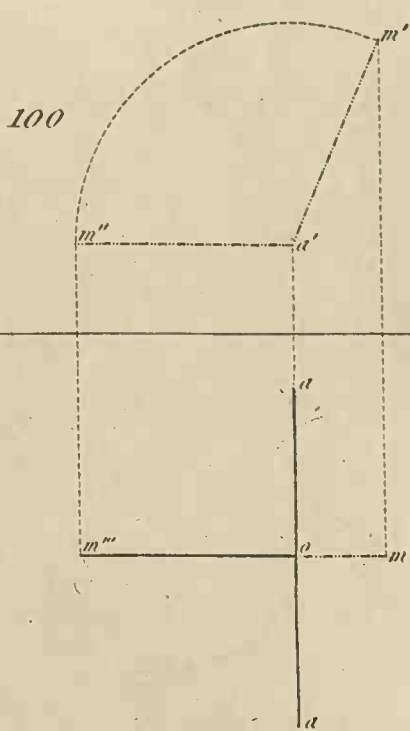
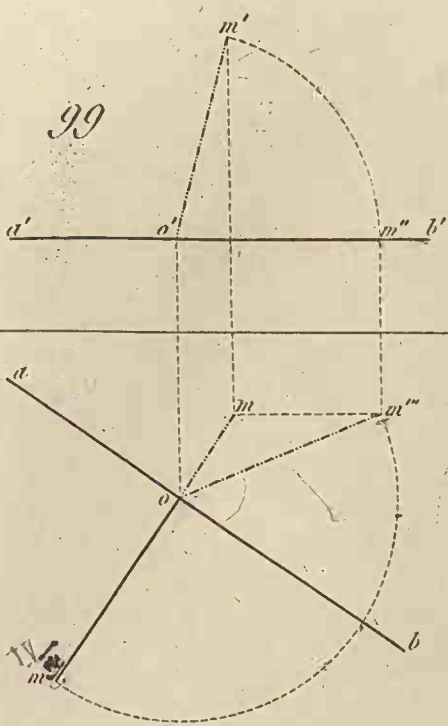

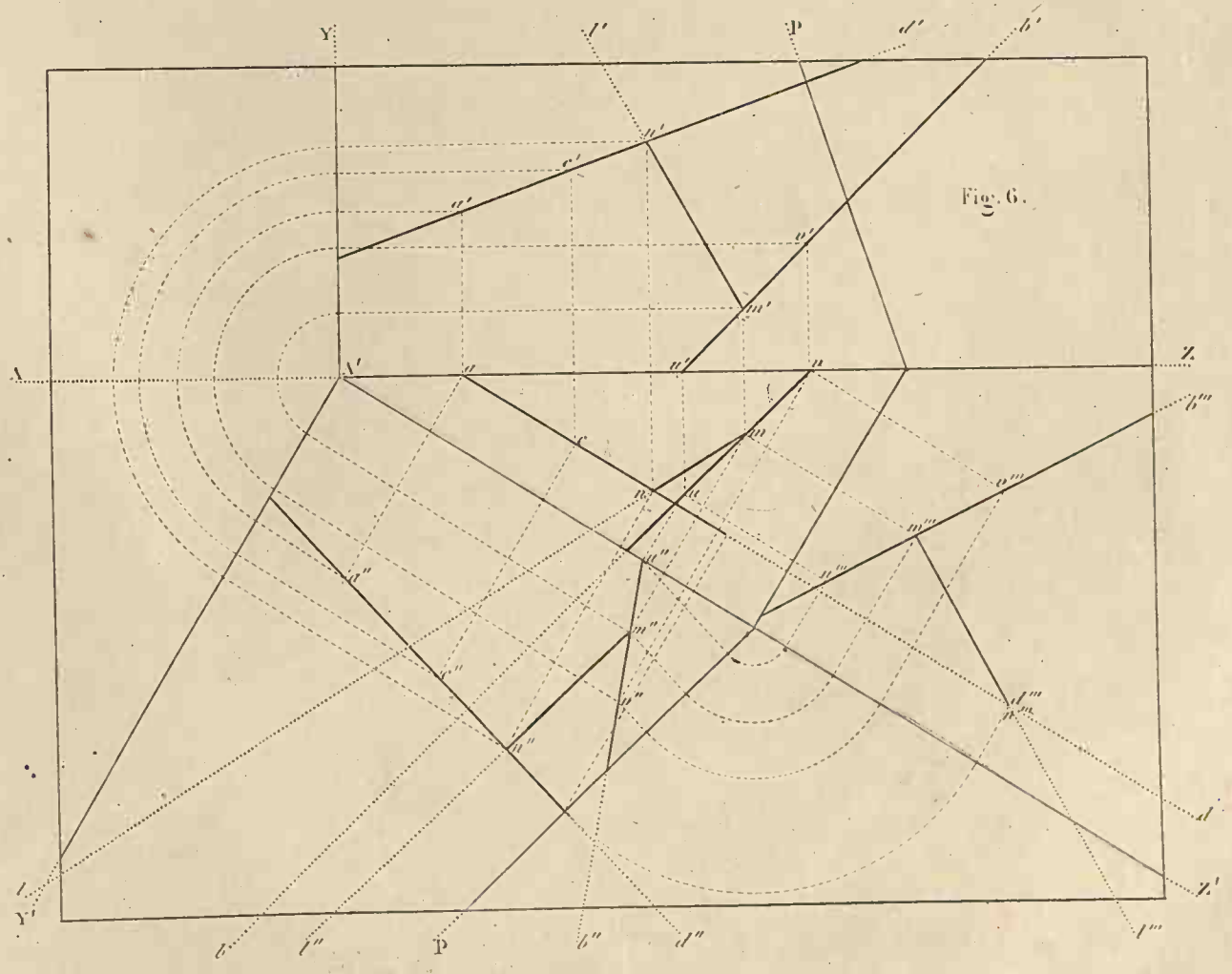
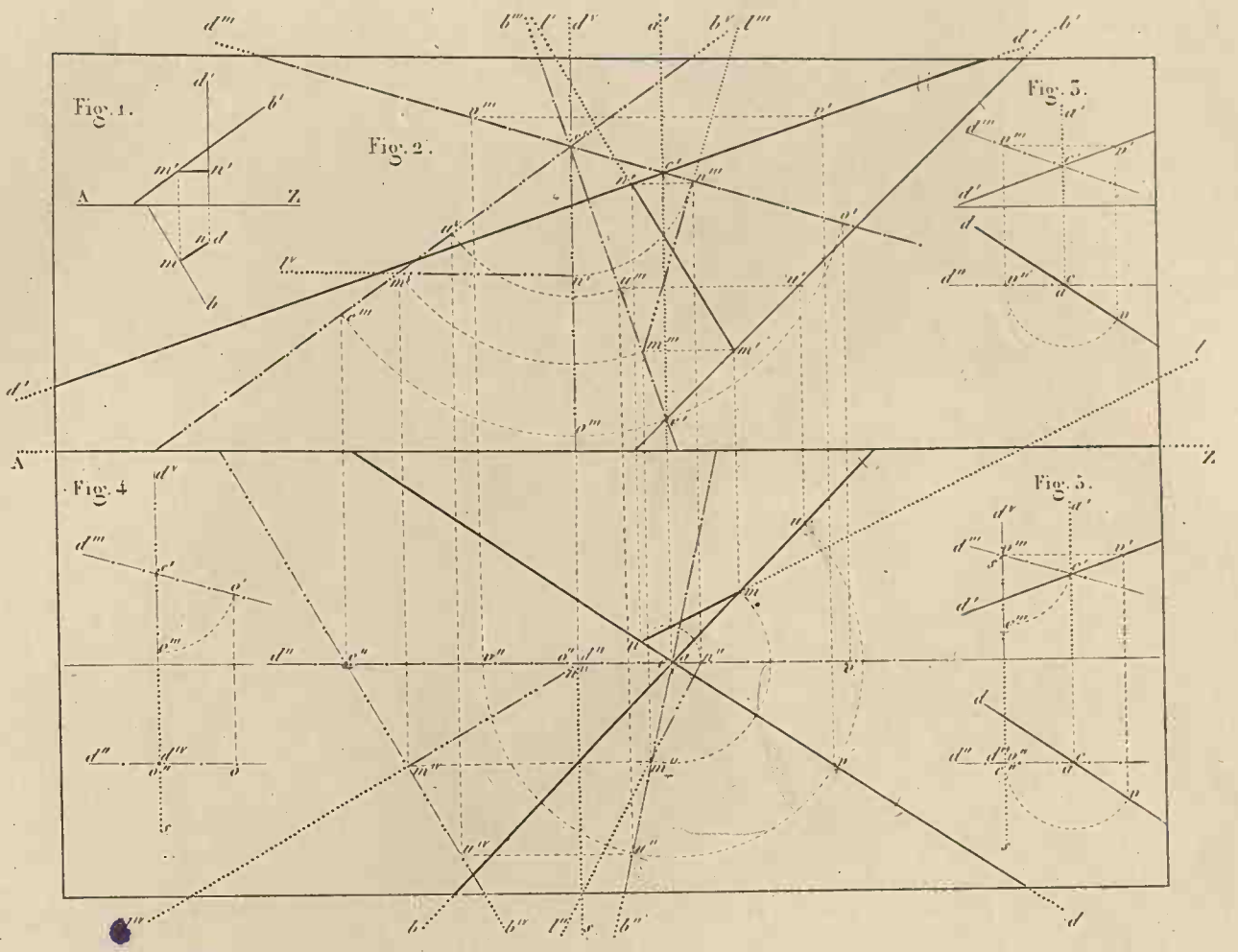

Geometrie descriptive.

Fig. 106.

109

108

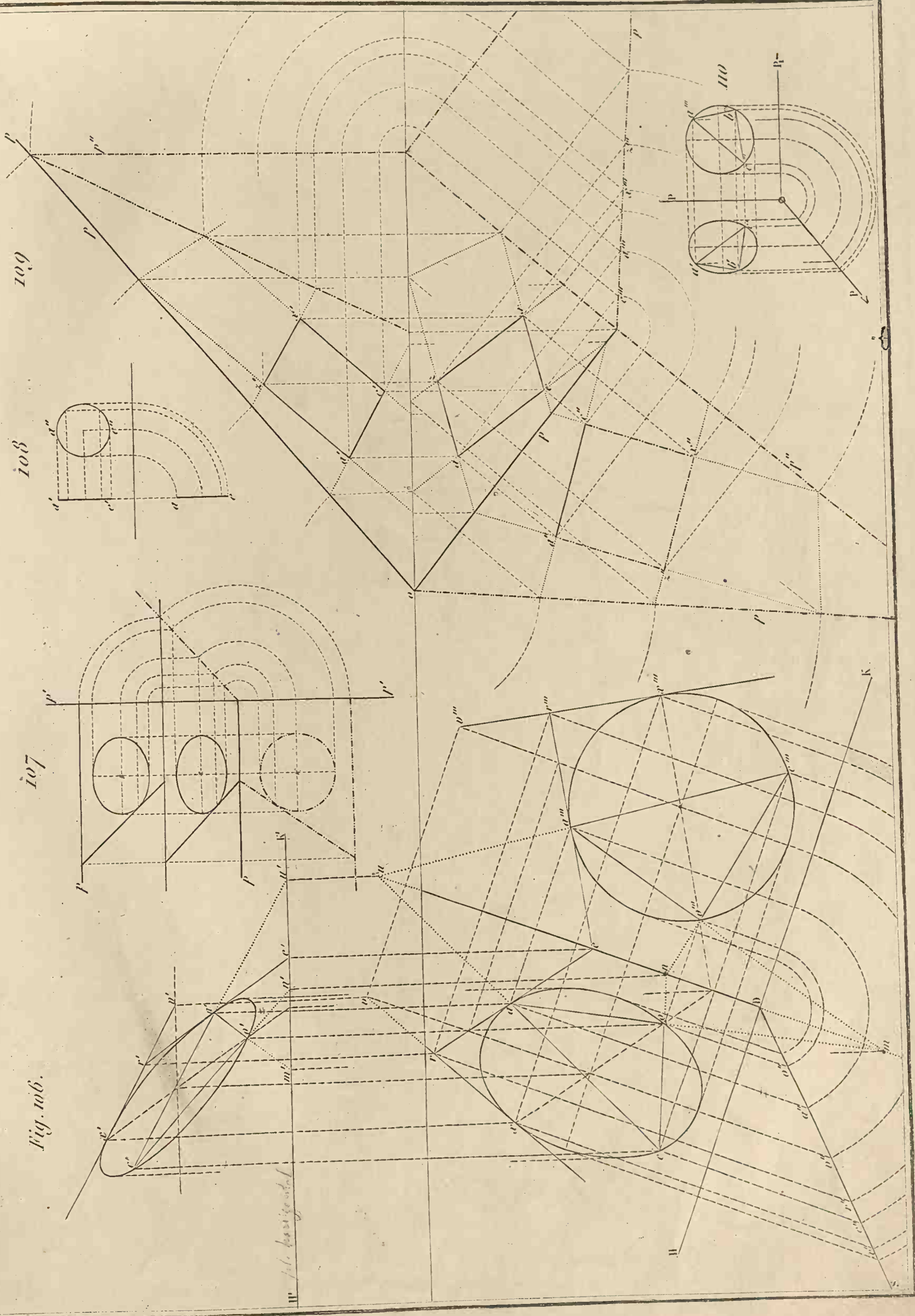

W. J. K. Geometrie

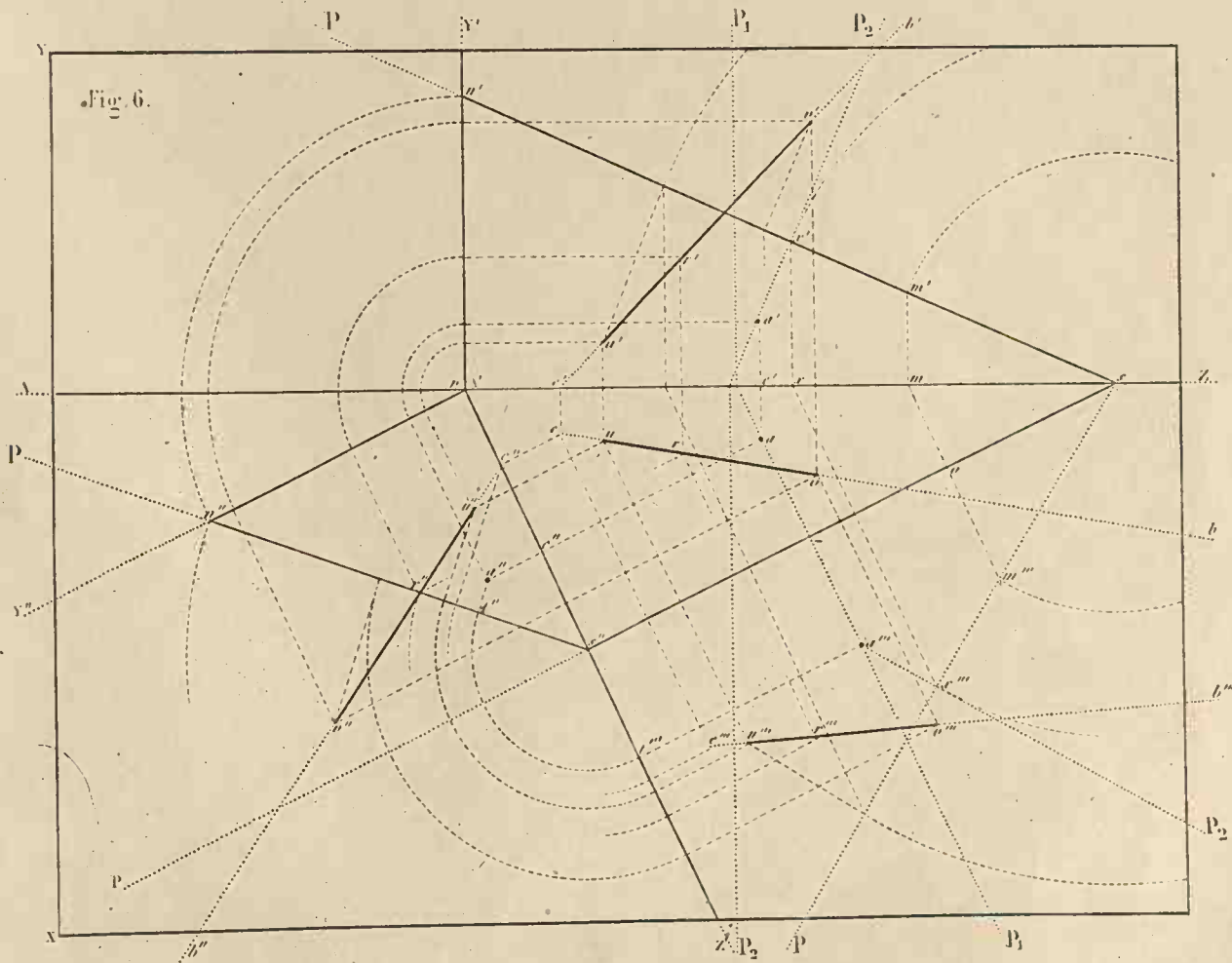
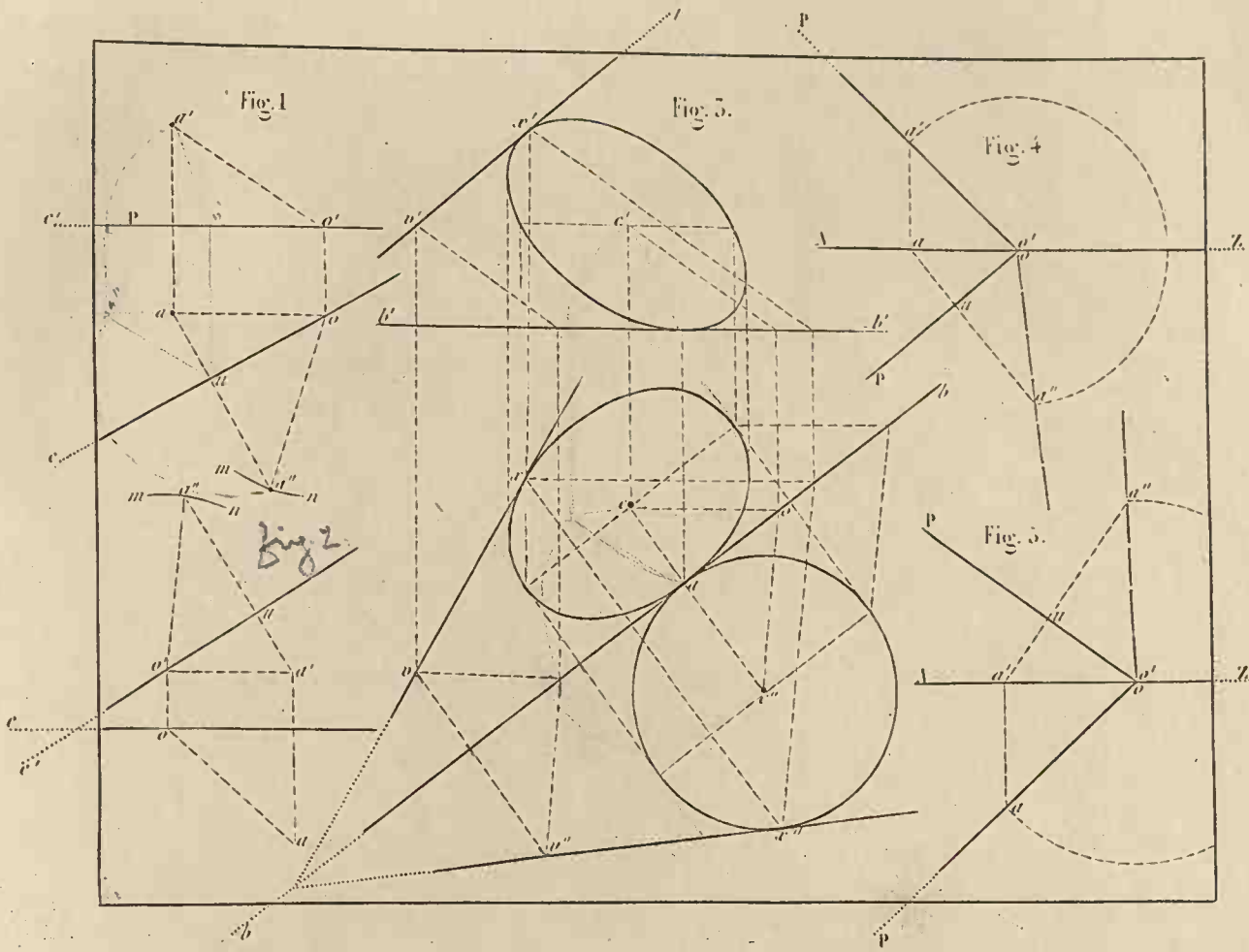

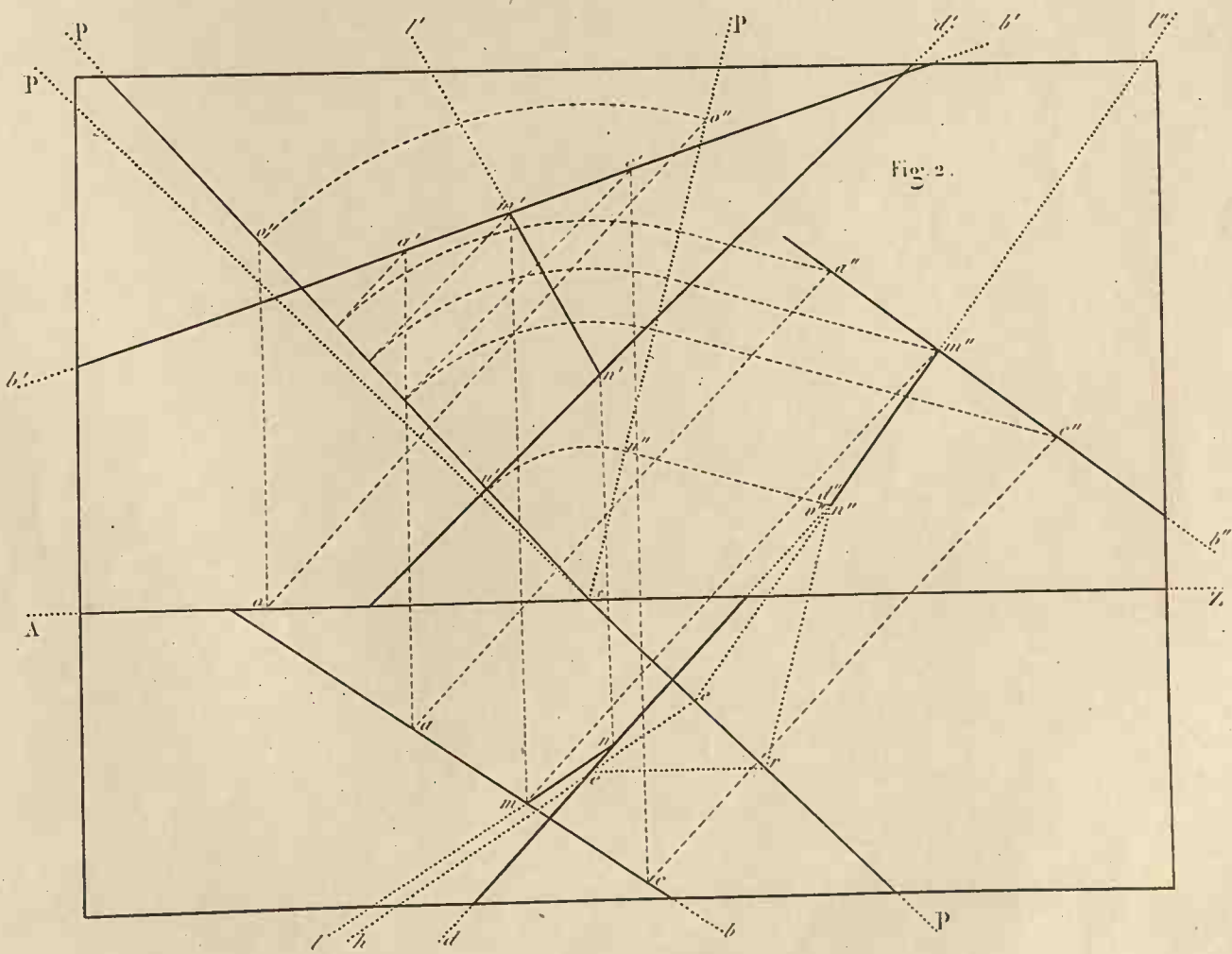
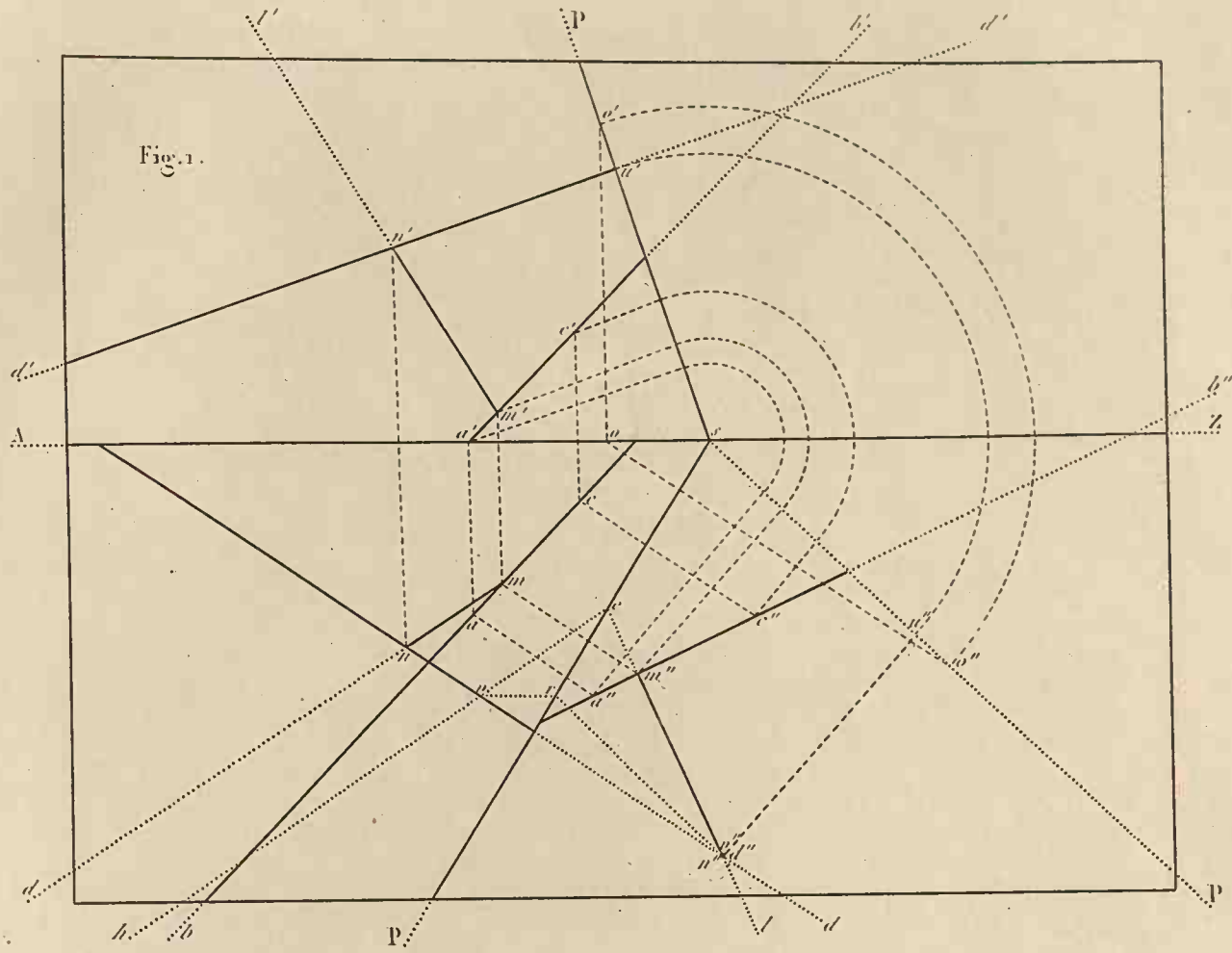

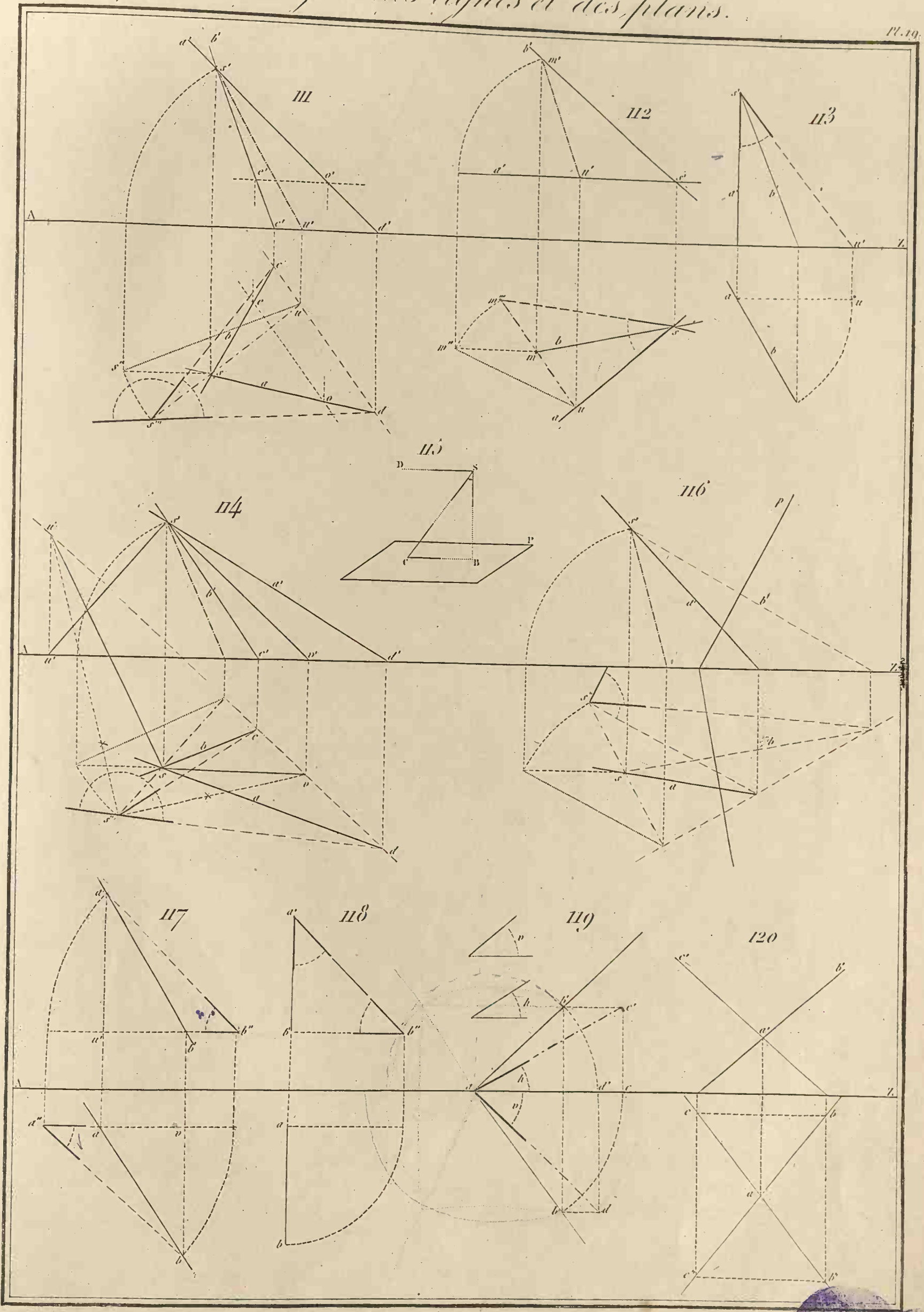

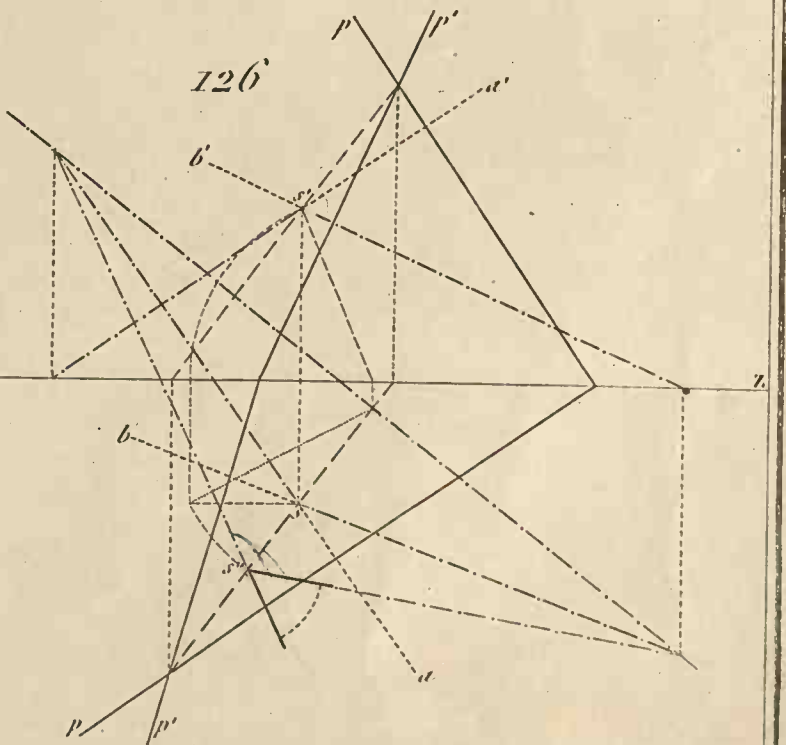
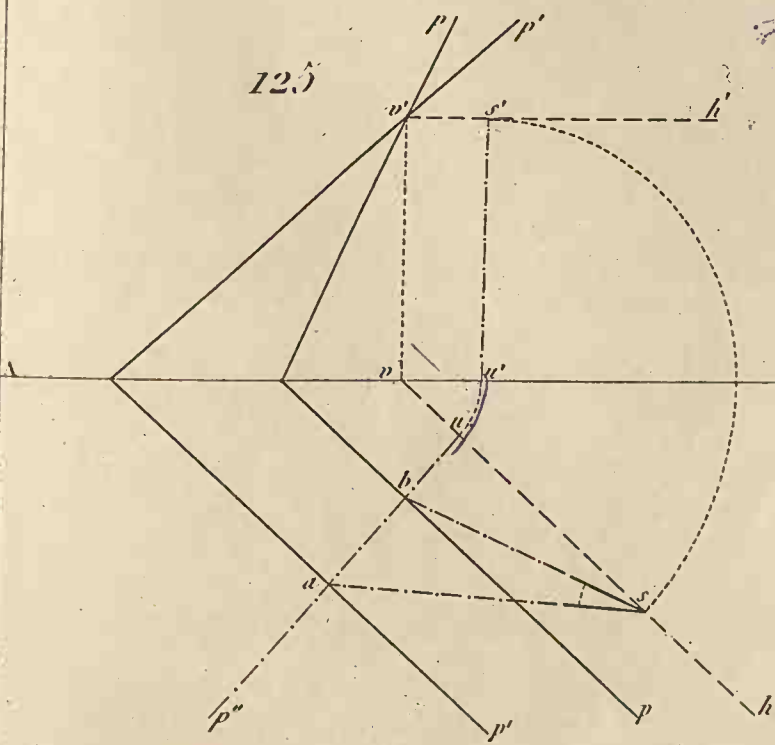
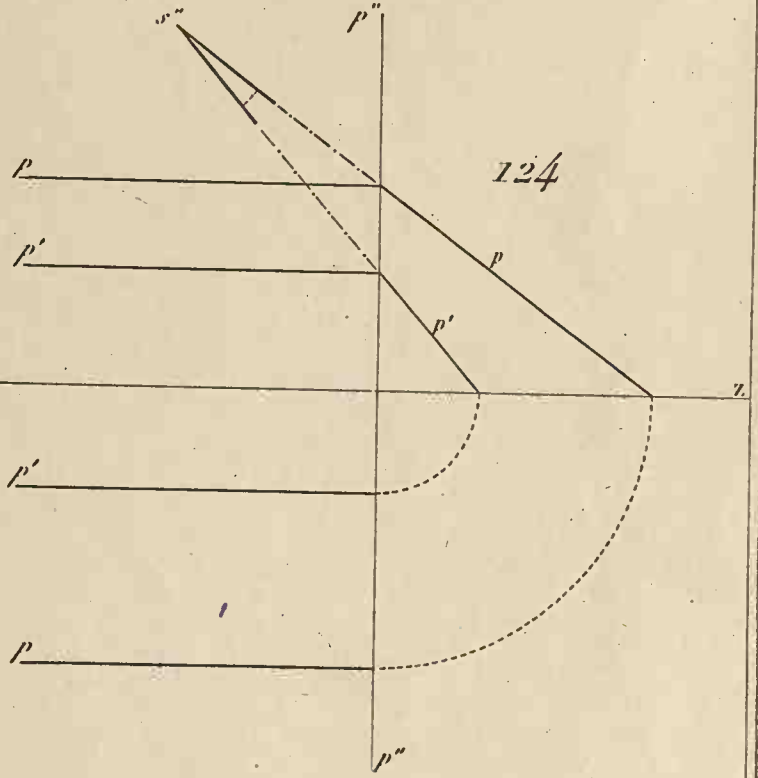
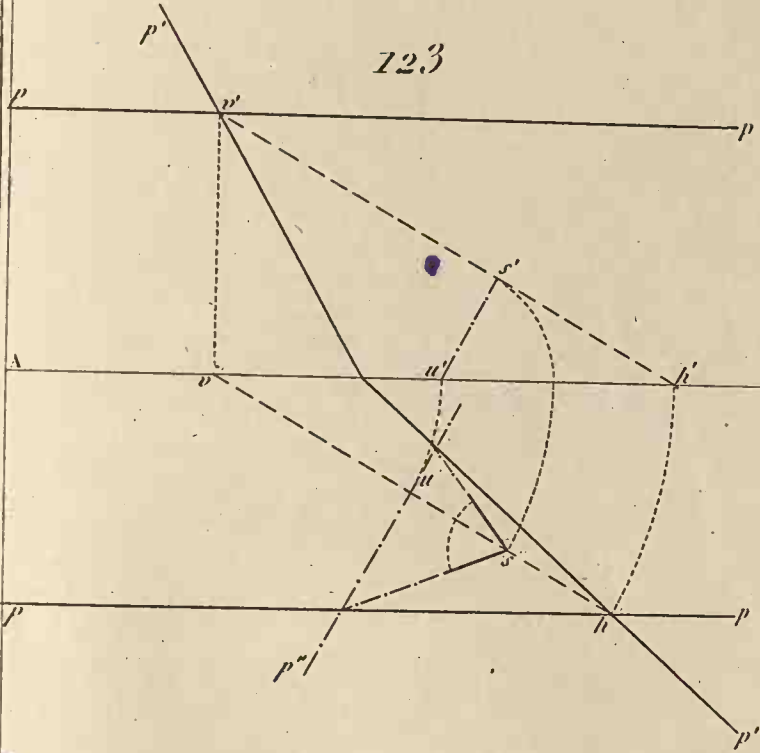
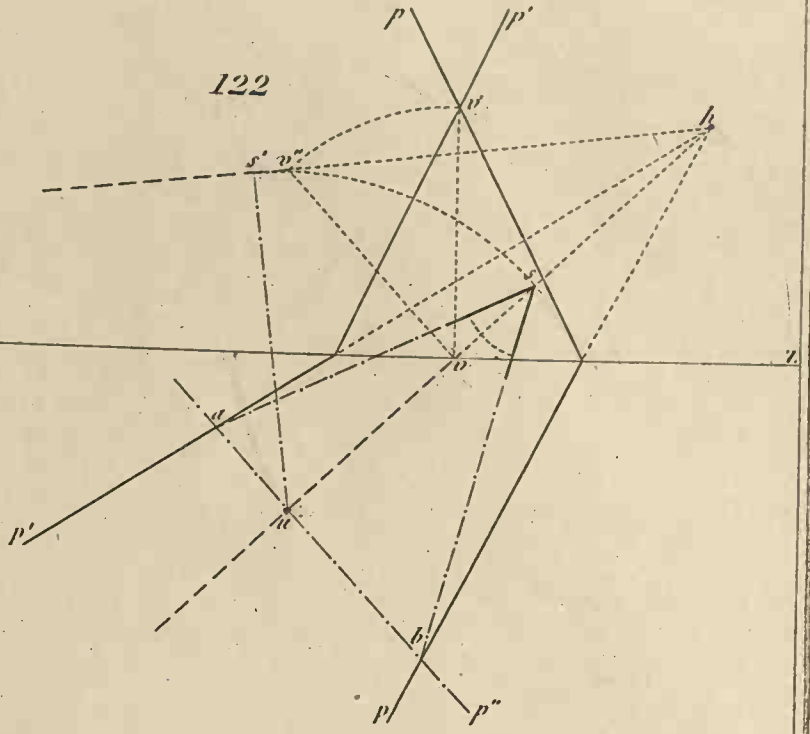
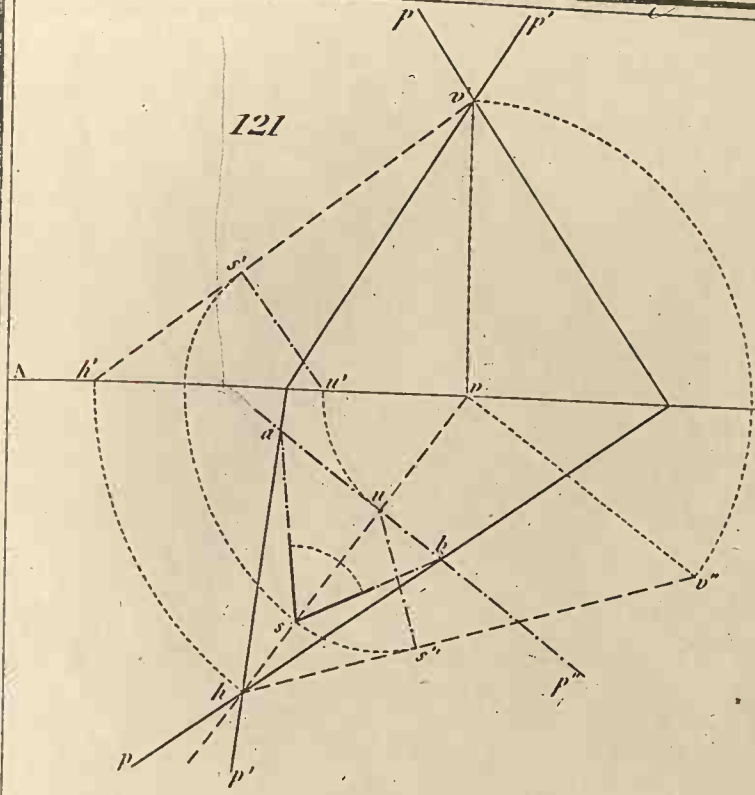

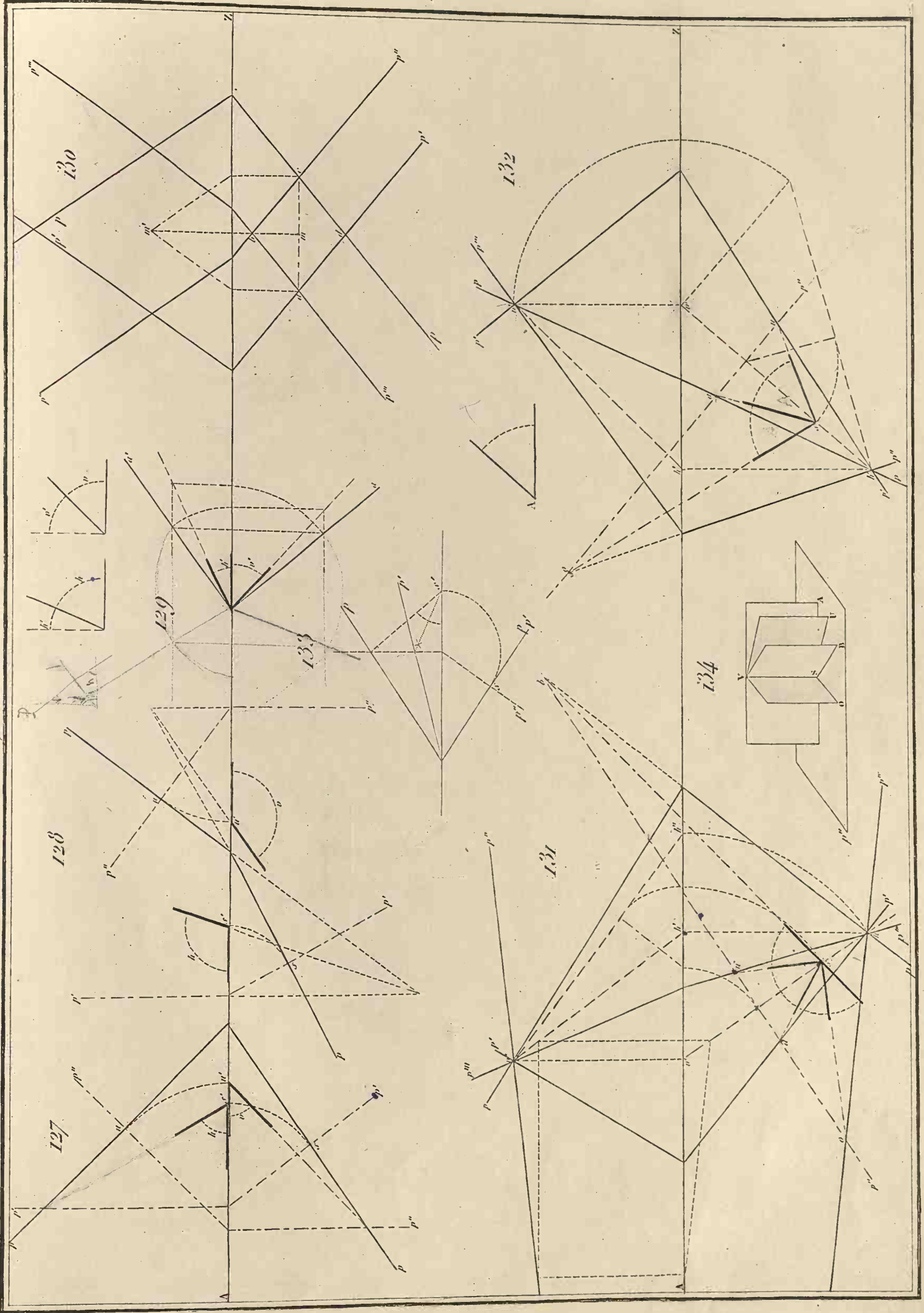

135

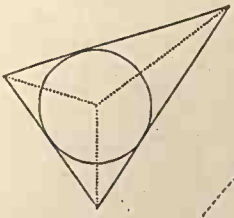

136

137

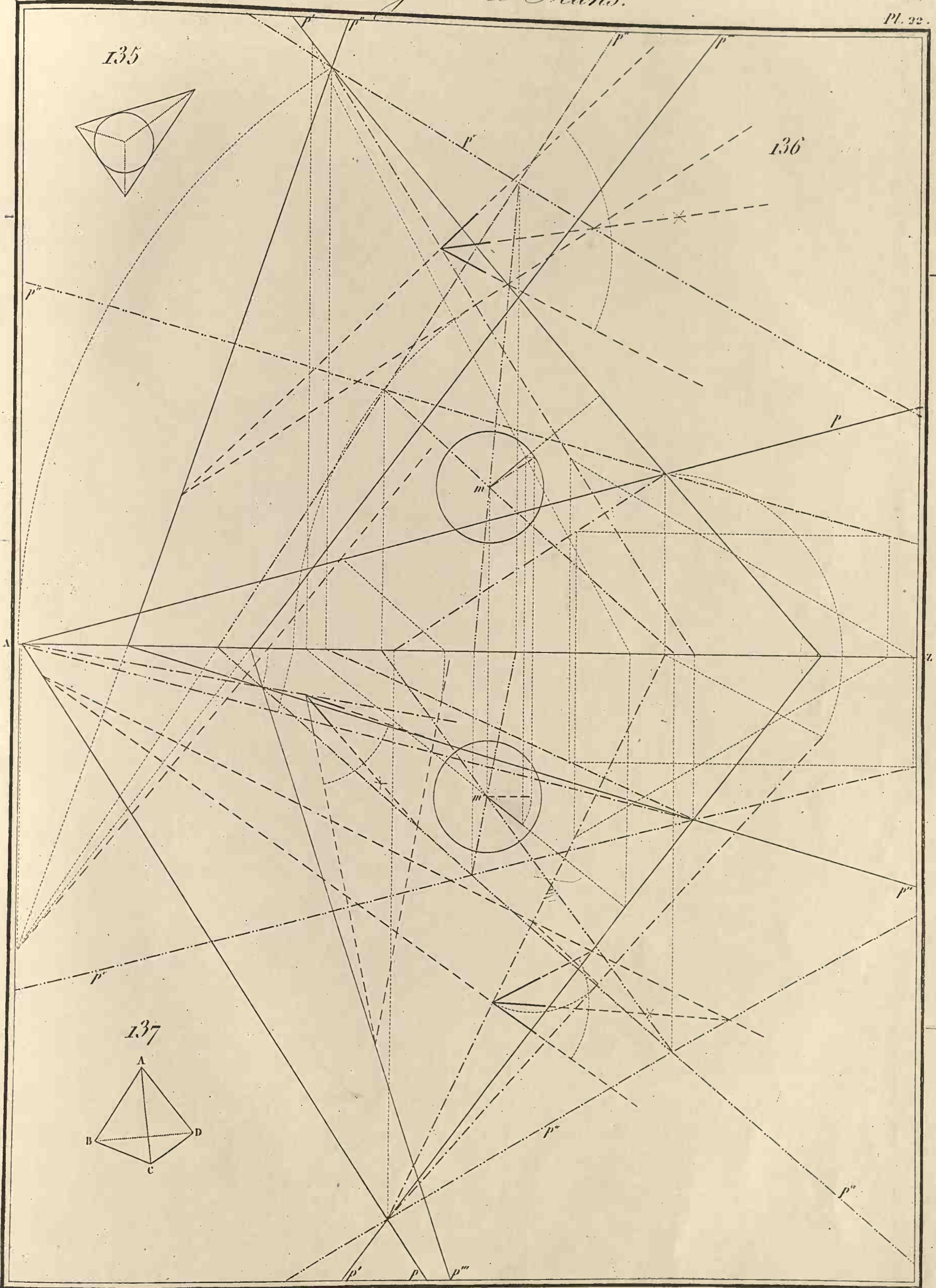
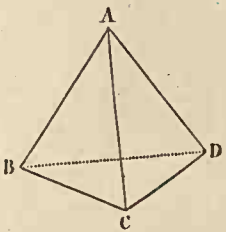

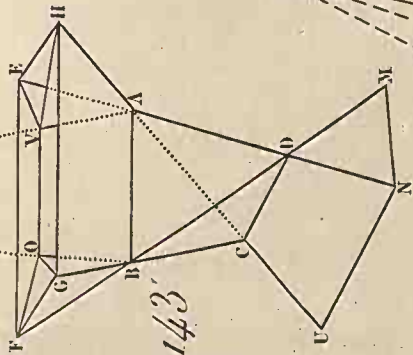

143

139

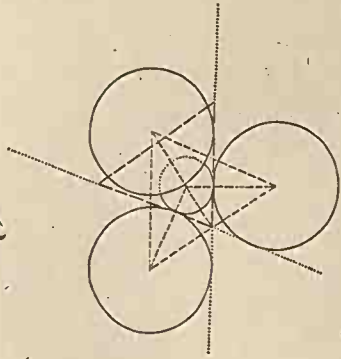

138

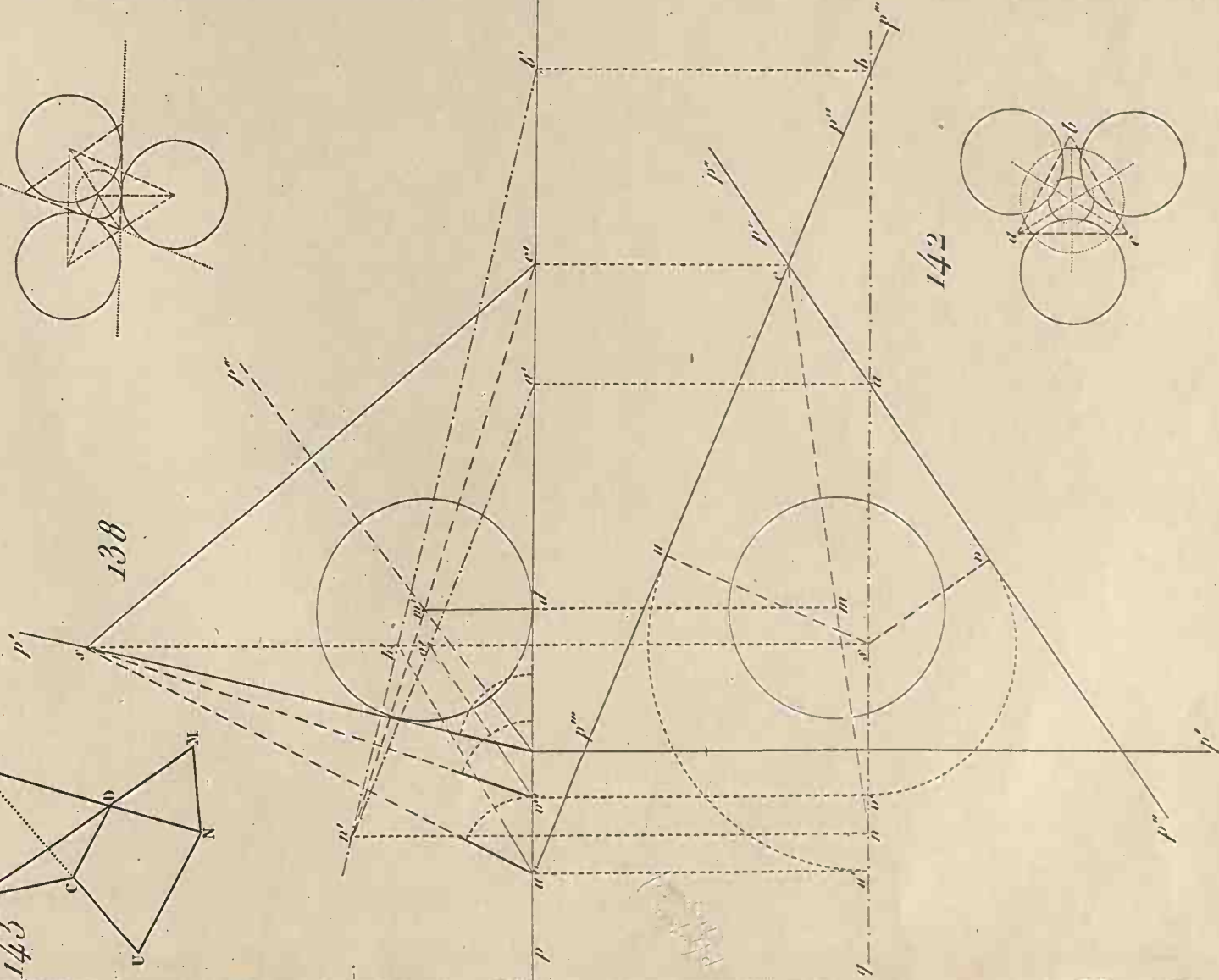

142

140

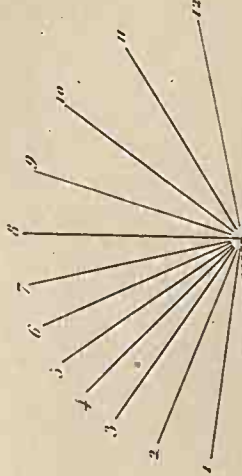

141

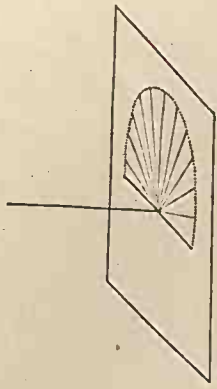

Fig. 1.

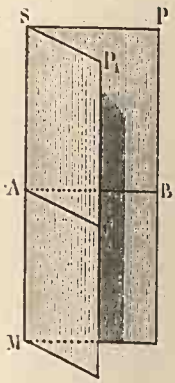

Fig. 2.

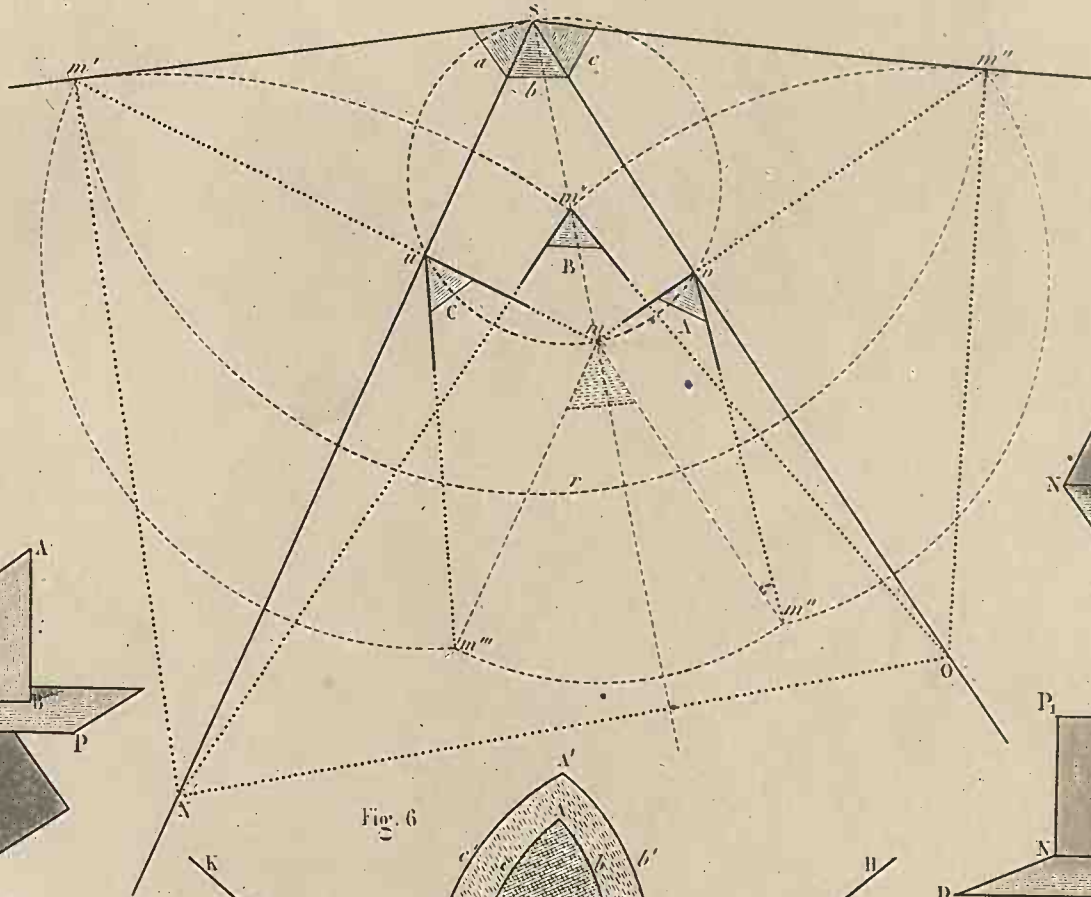

Fig. 3.

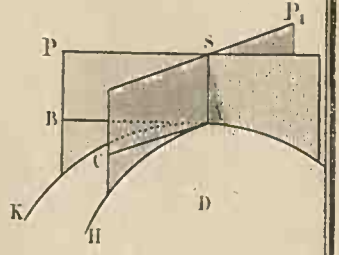

Fig. 4.

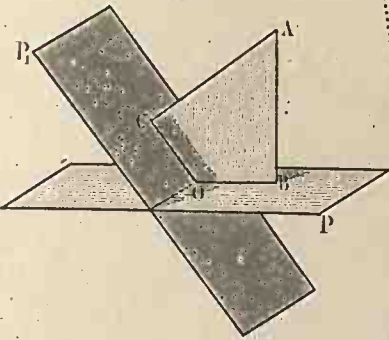

Fig. 5.

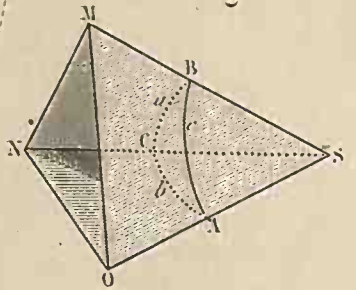

Fig. 6.

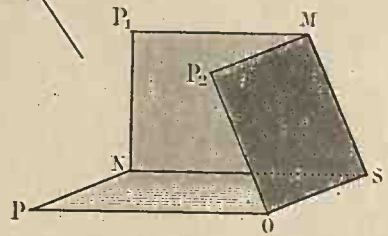

Fig. 7.

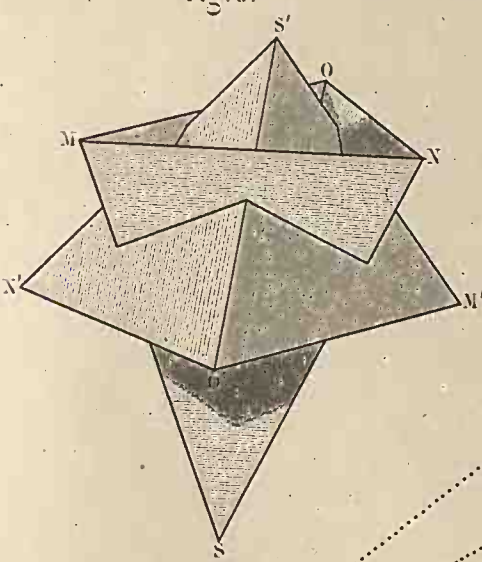

Fig. 8.

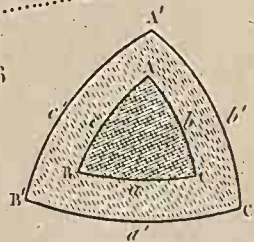

Fig. 9.

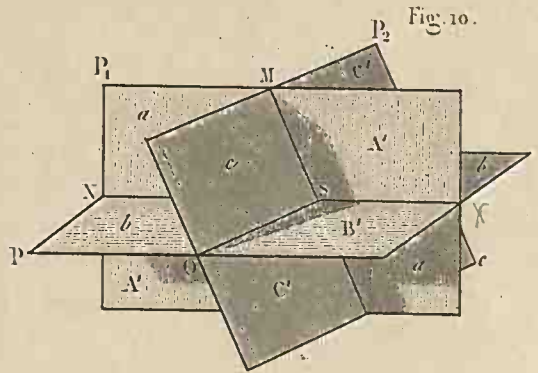

Fig. 10.

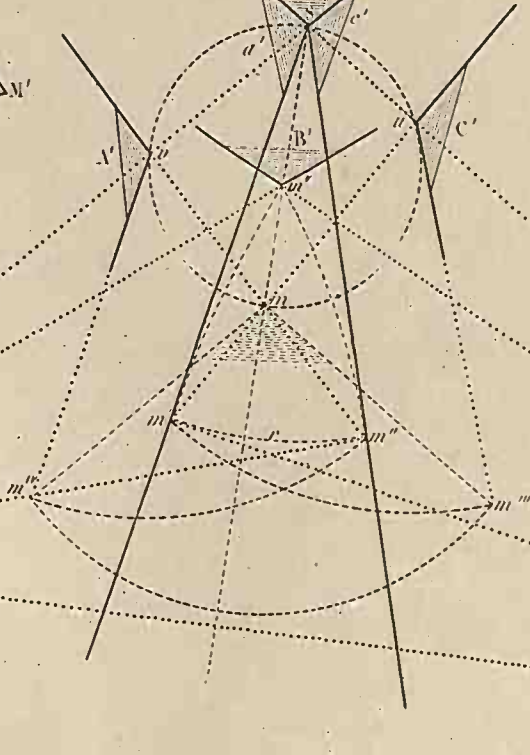

Fig. 11.

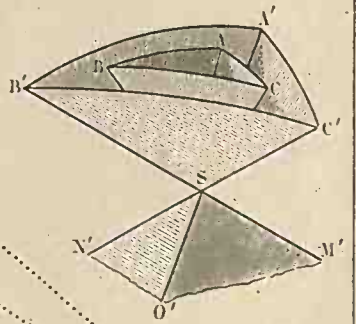

Fig. 12.

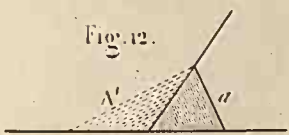

Fig. 13.



Fig. 14.



Fig. 15.

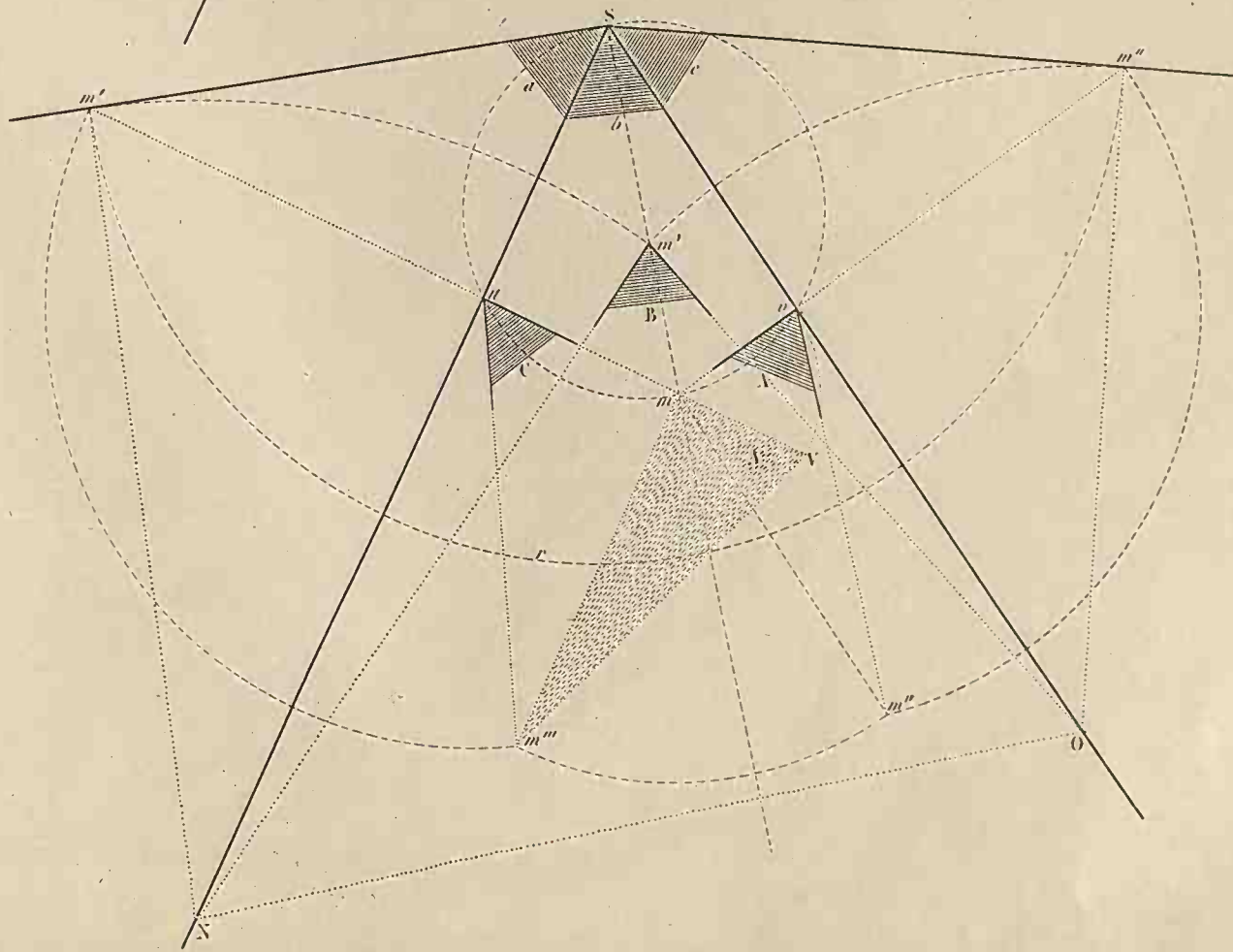
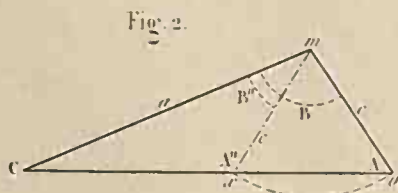
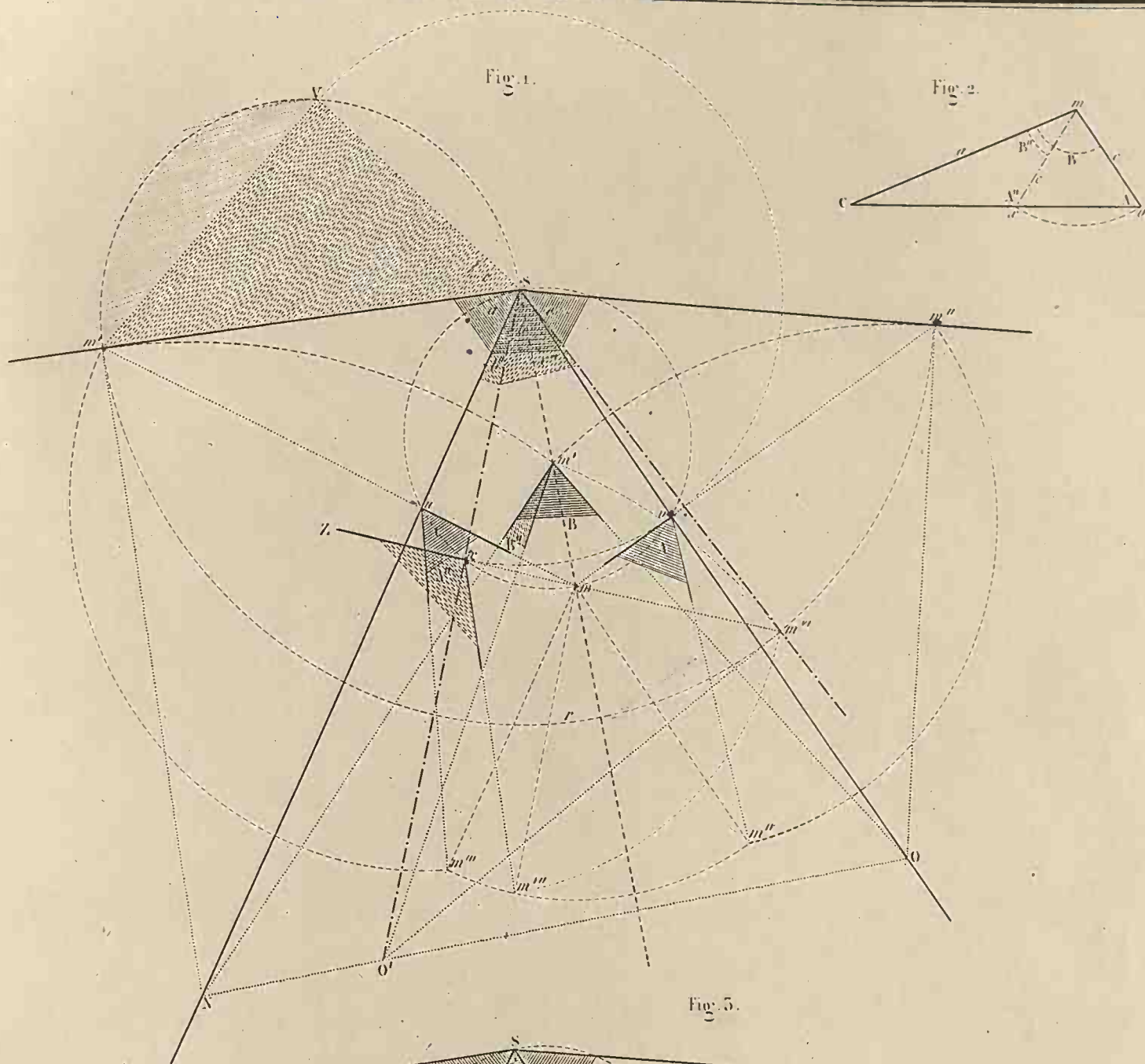

Fig. 16.



Fig. 17.





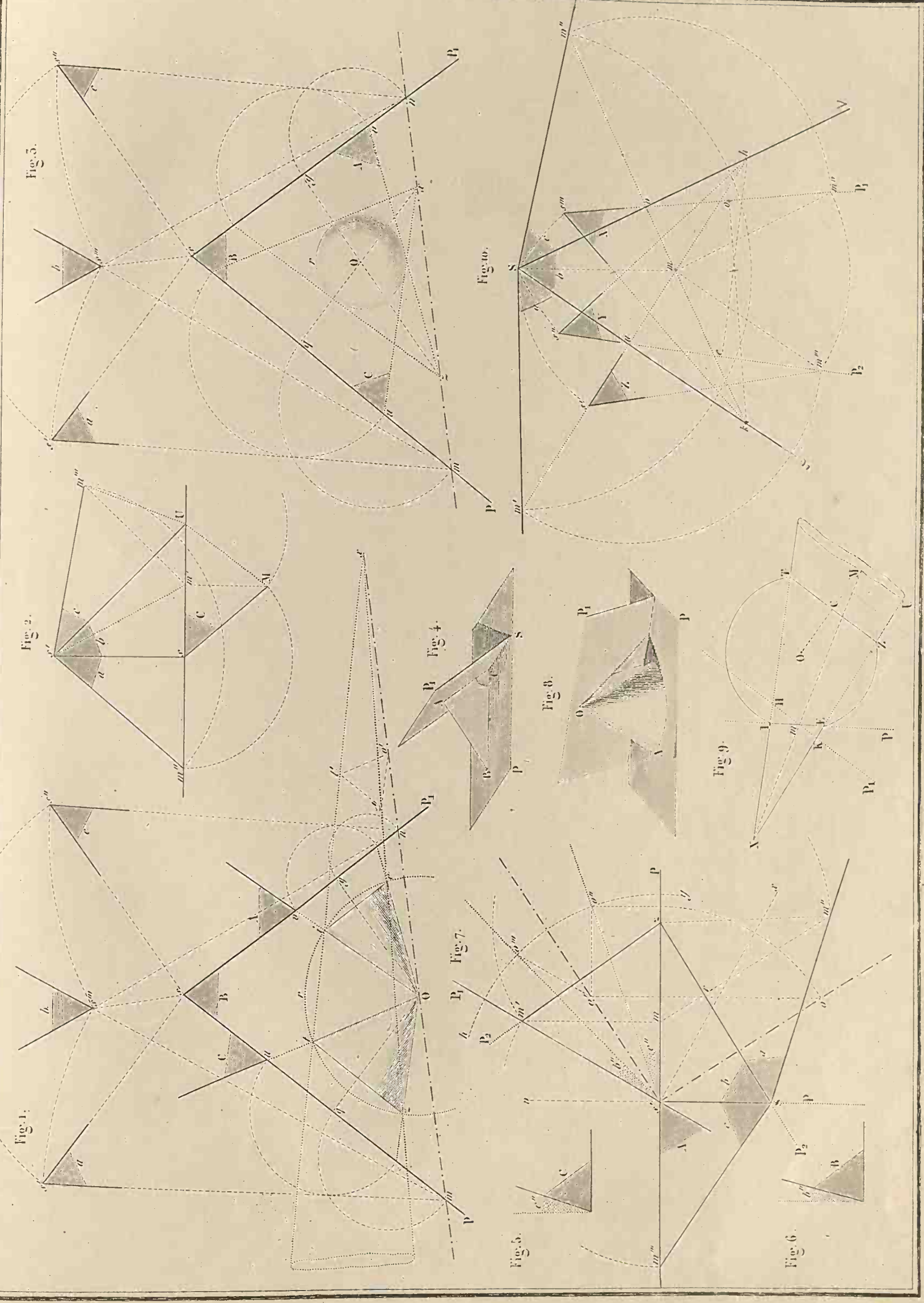
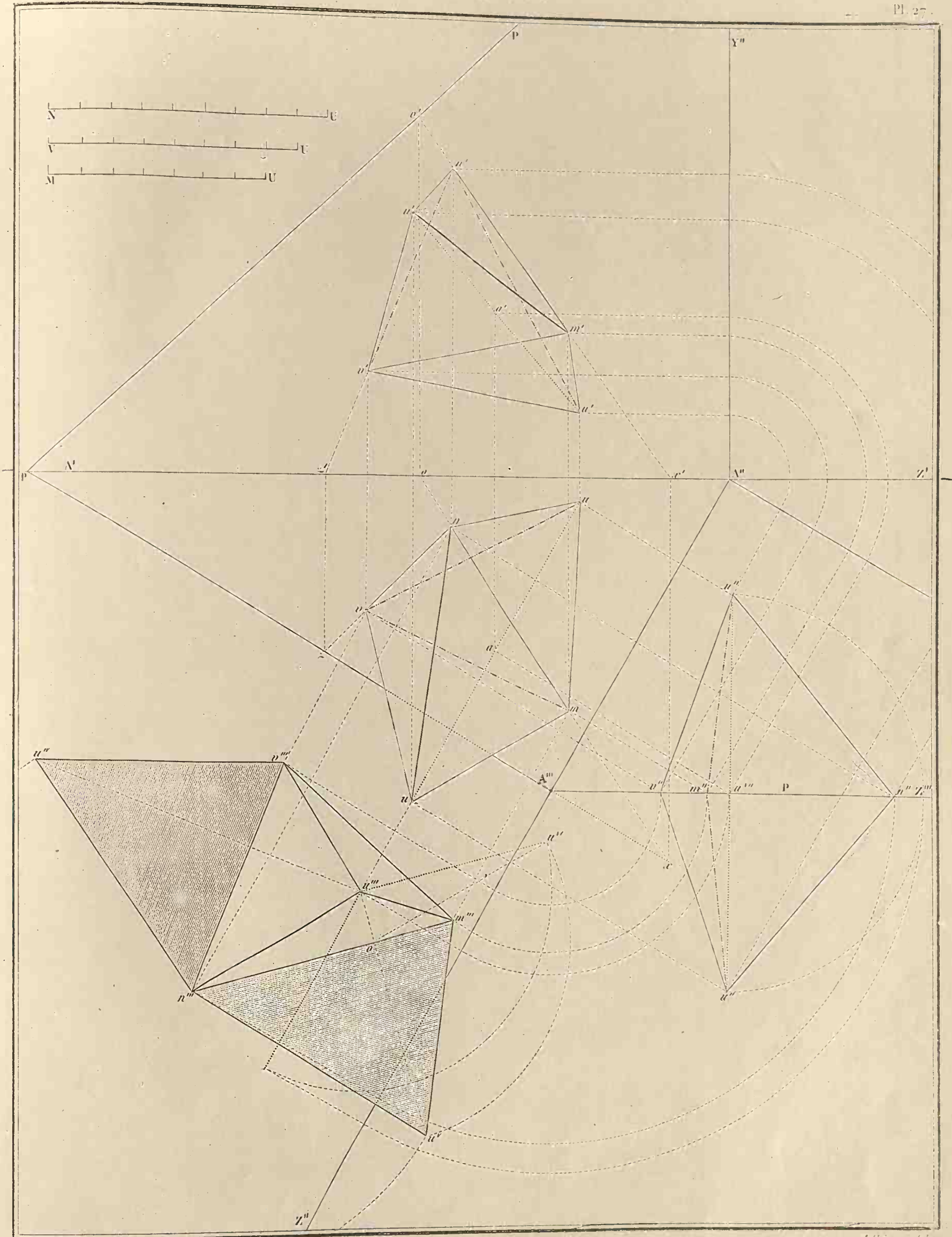
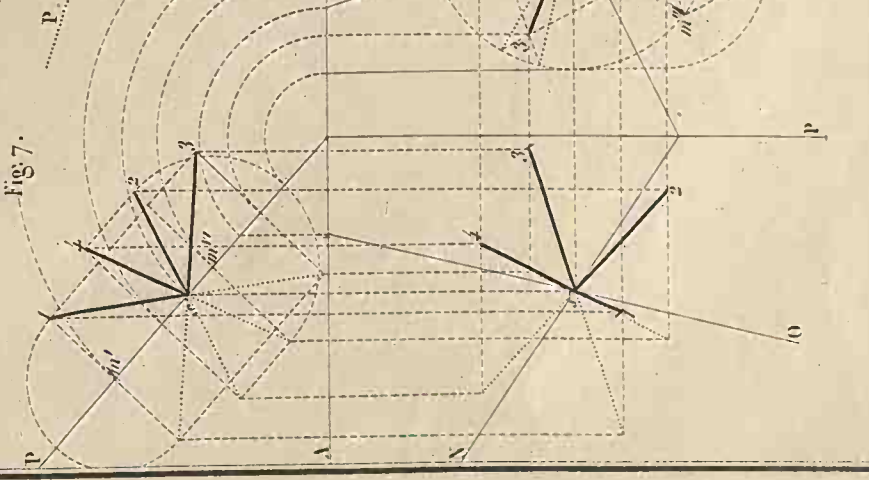
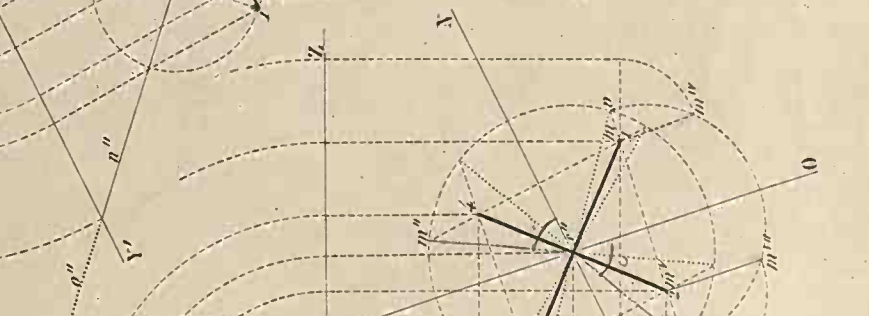
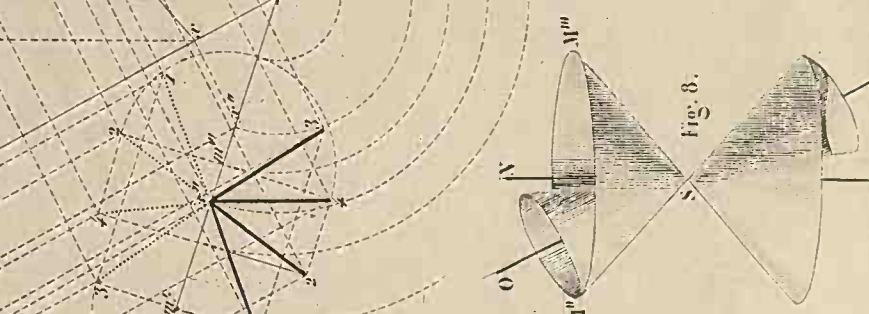
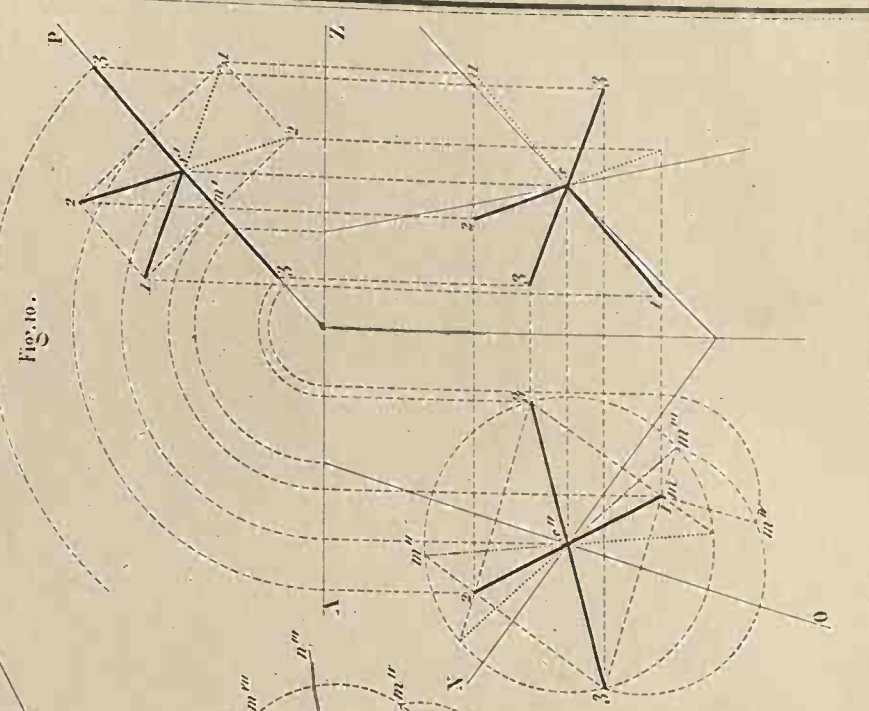
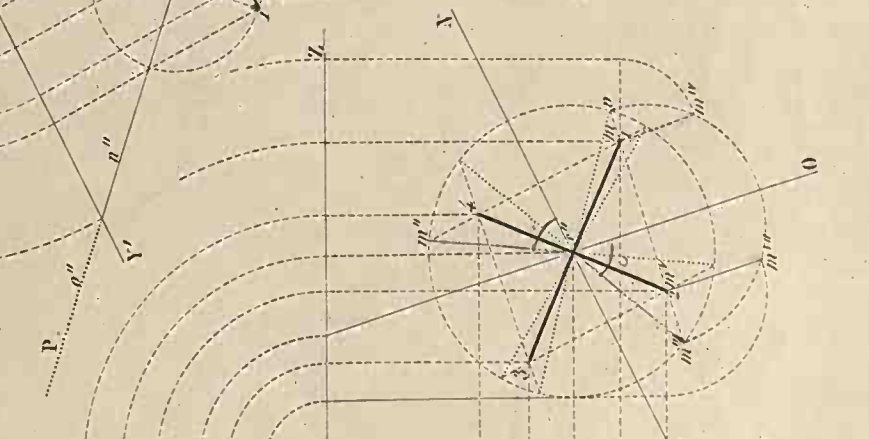
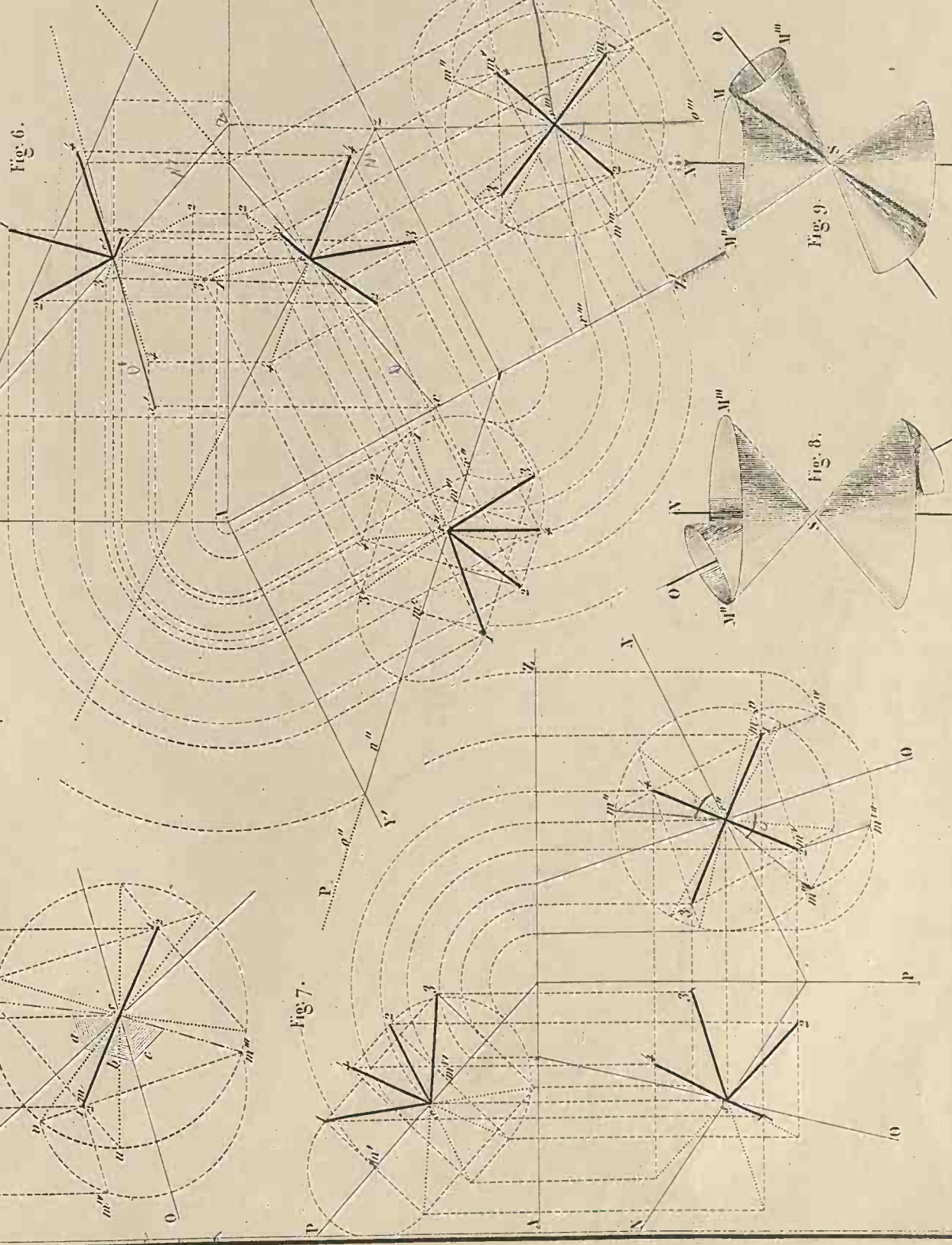
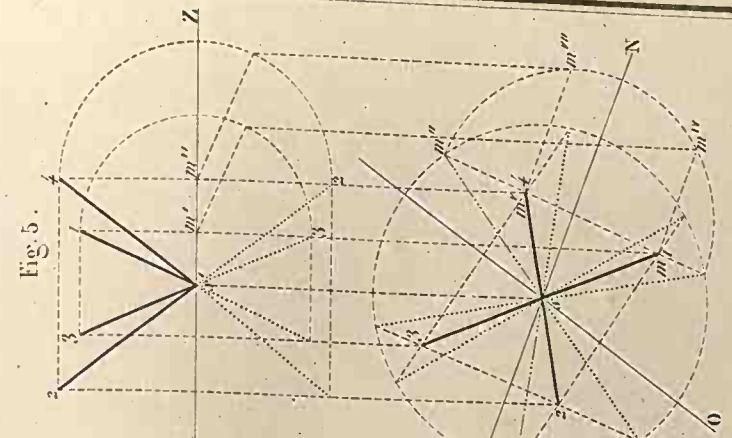
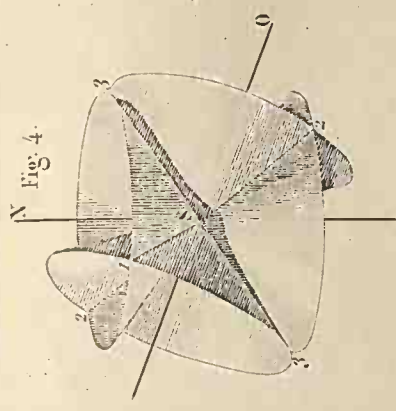
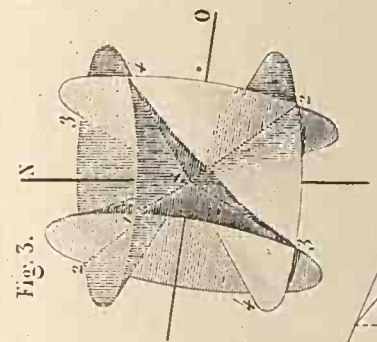
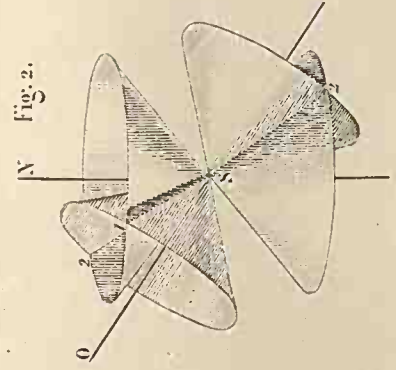
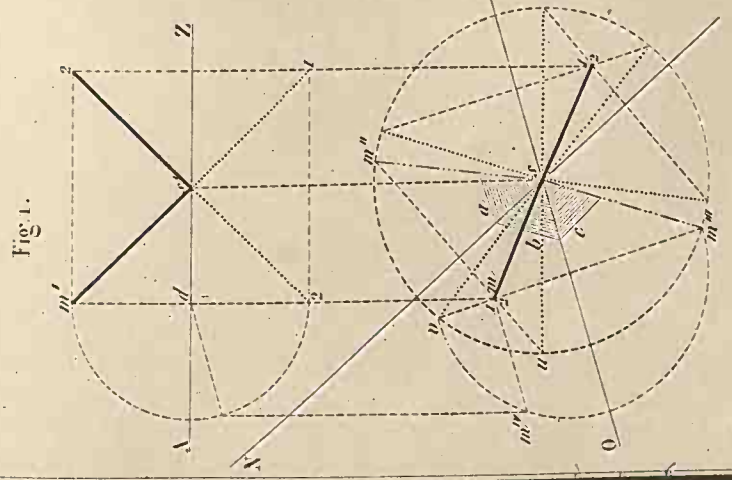
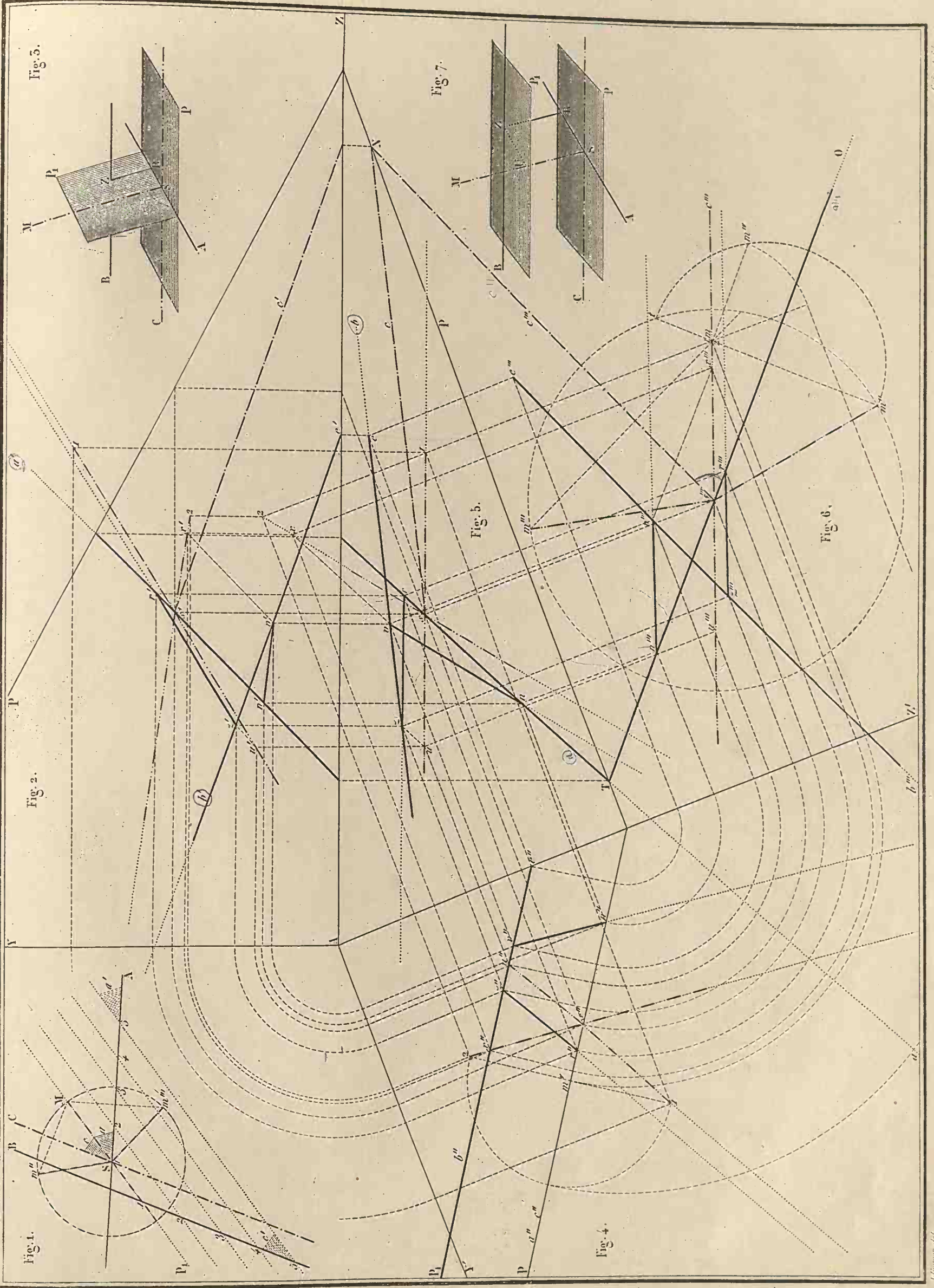

Fig. 10.

Fig. 6.







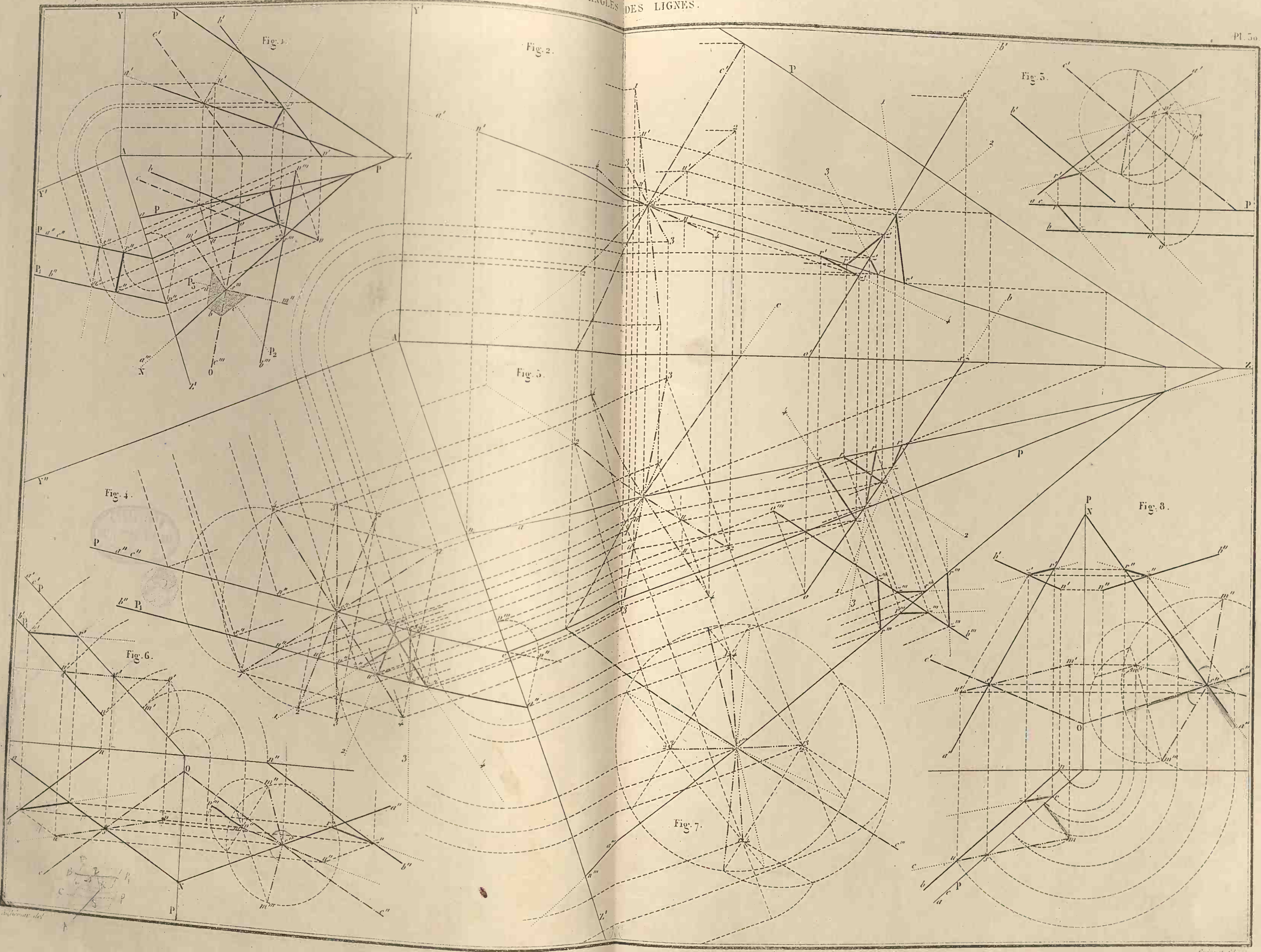

Fig. 1.

Fig. 2.

Fig. 5.

Fig. 3.

Fig. 4.

Fig. 8.

Fig. 6.

Fig. 7.

Del.

Gravé par J. B.

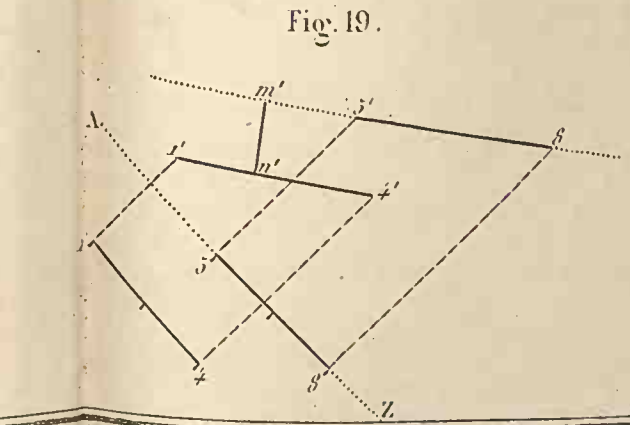
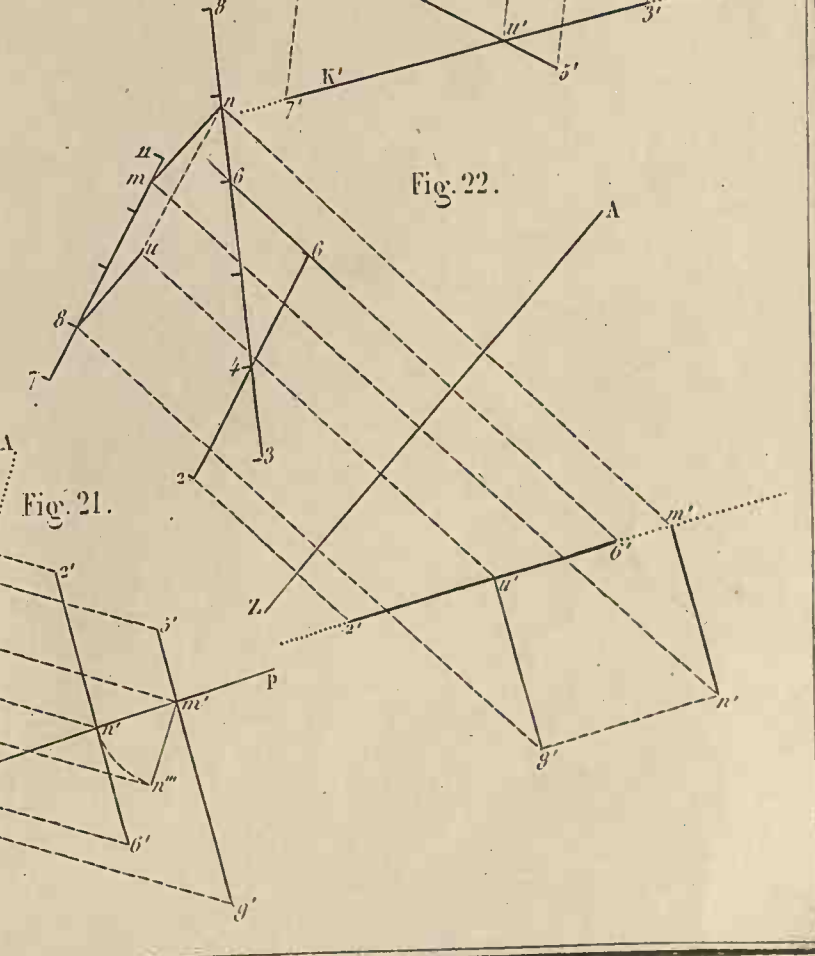
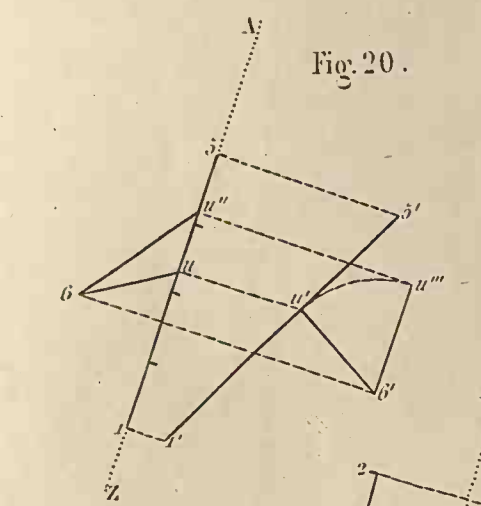
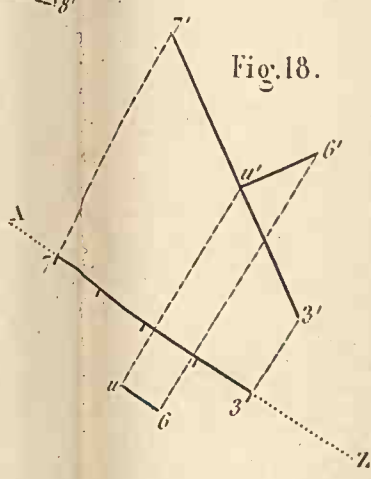
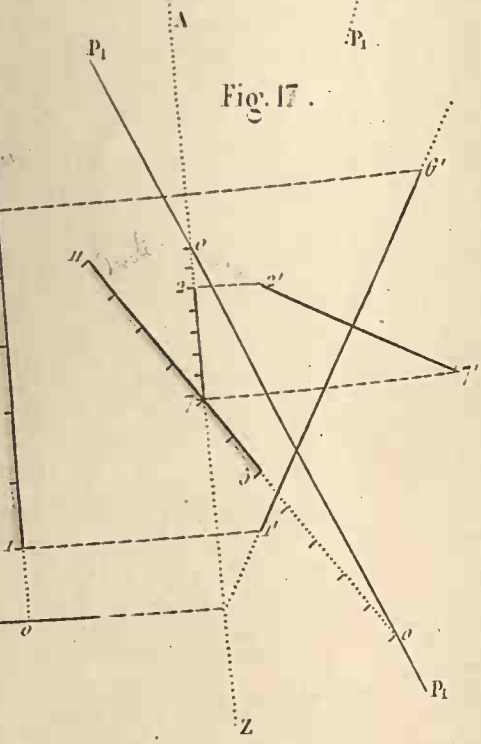
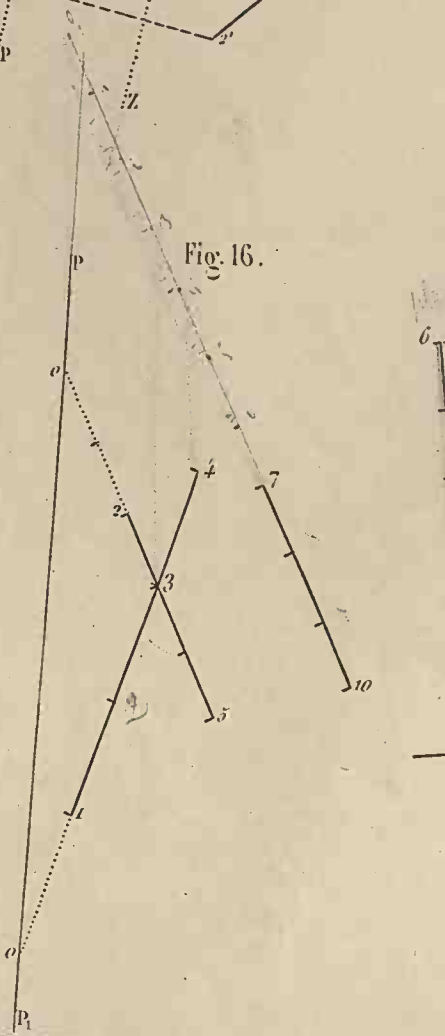
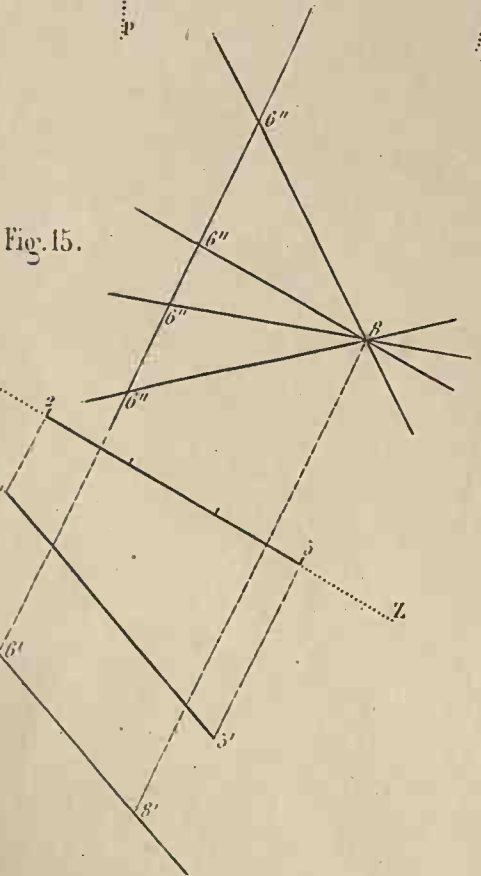
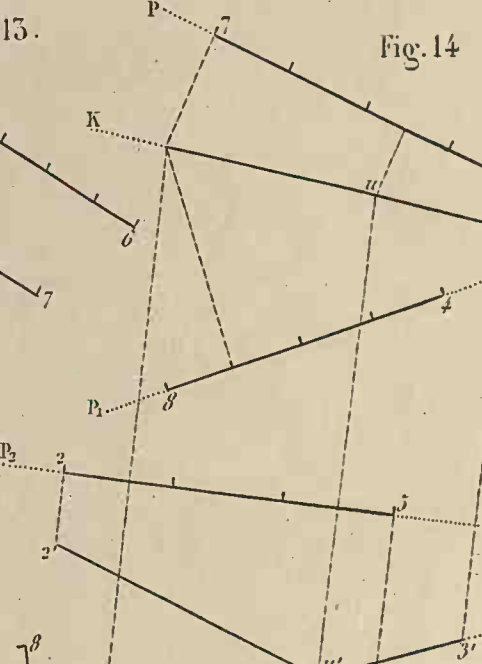
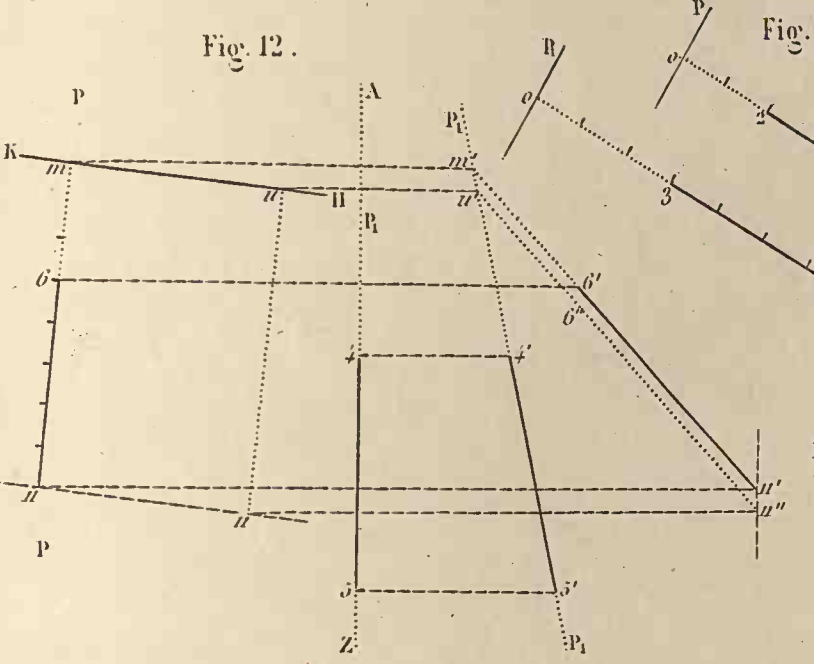
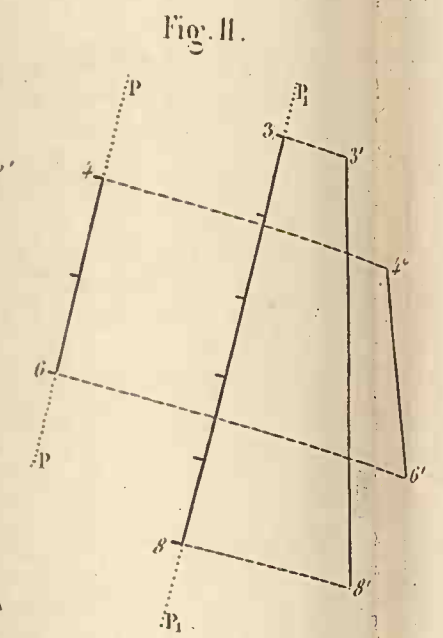
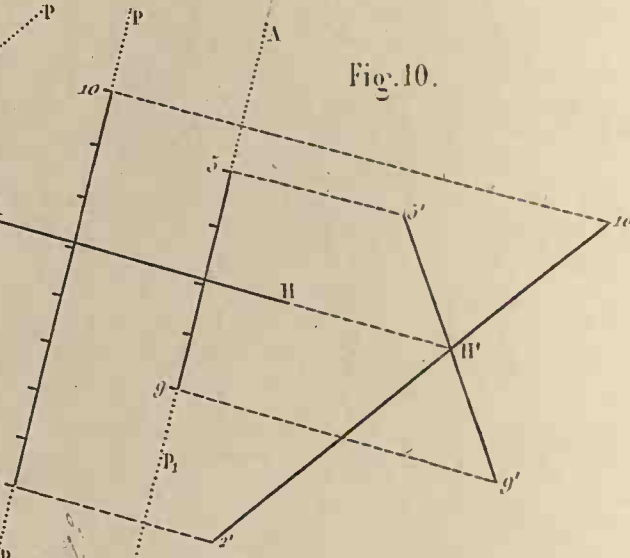
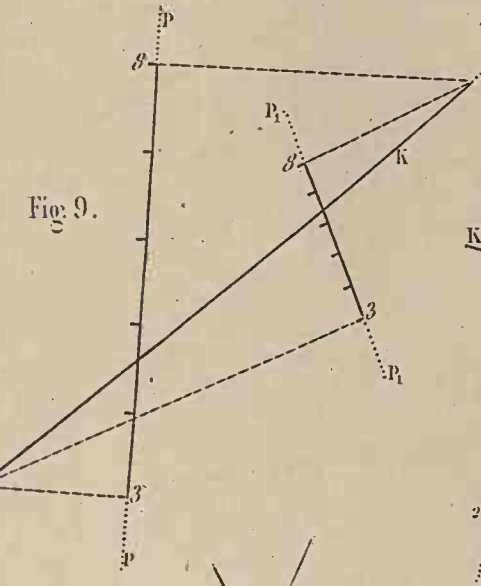
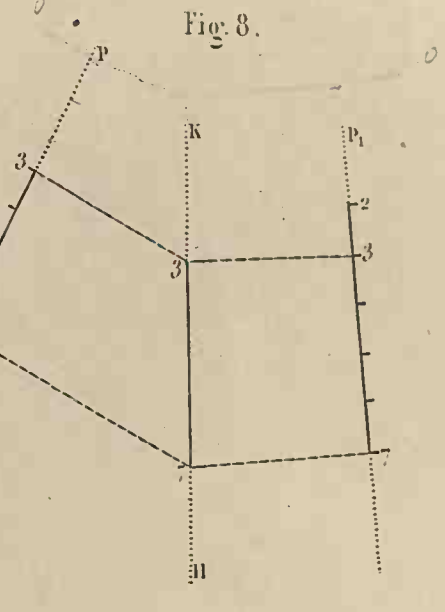
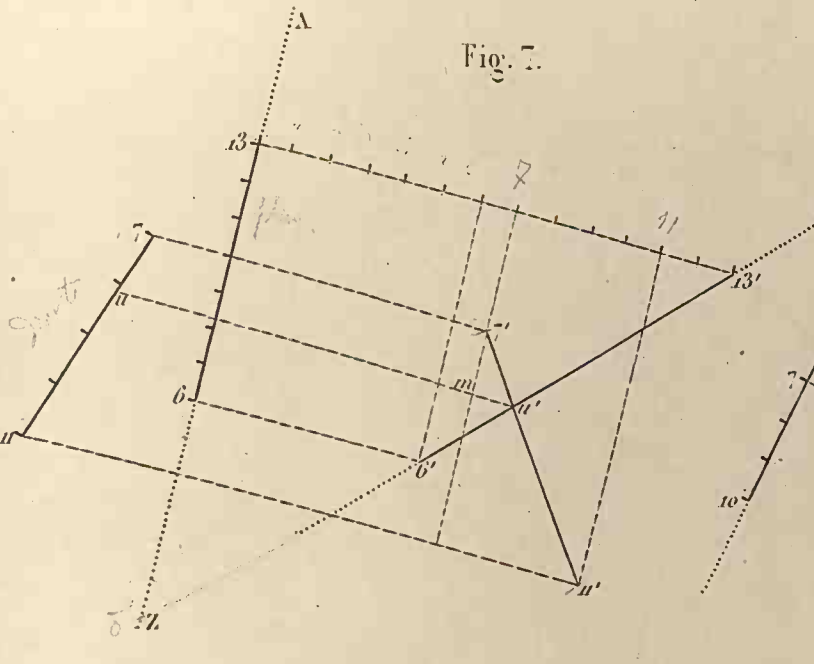
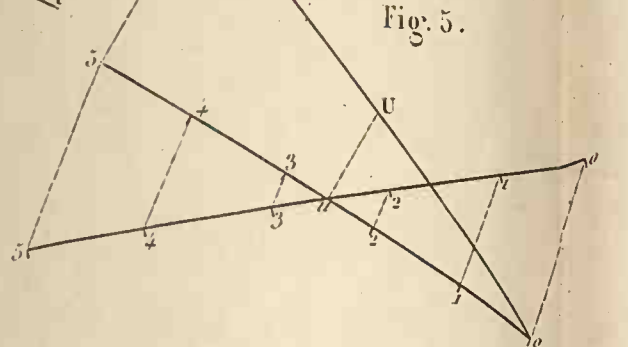
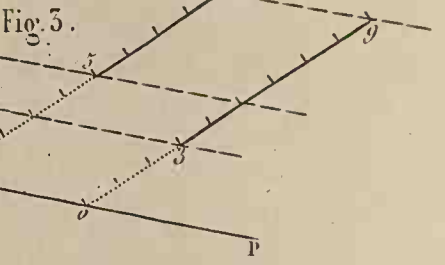
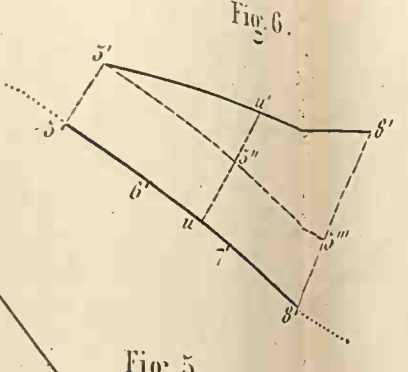
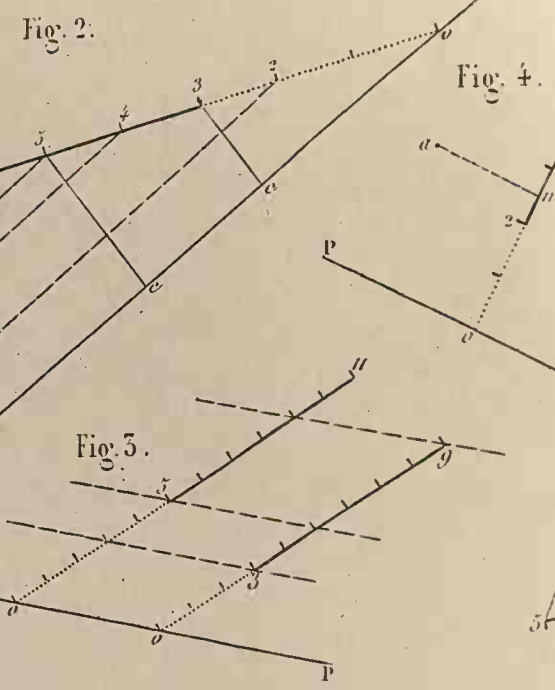
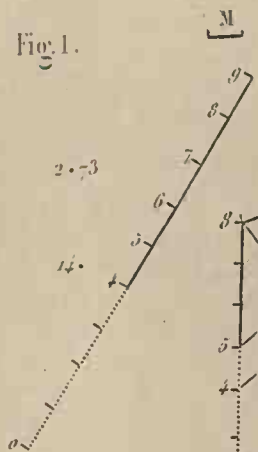

146

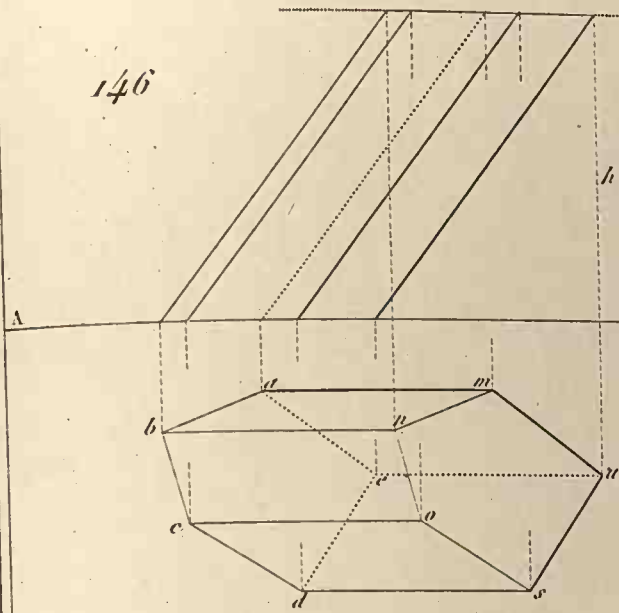

147

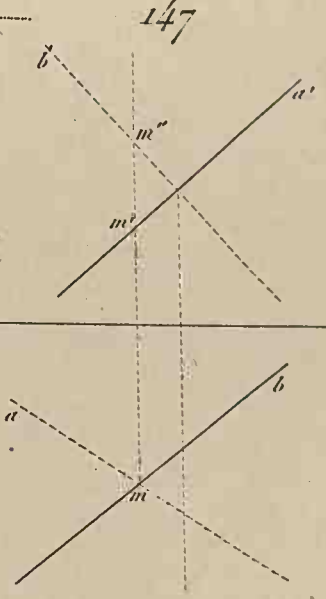

148

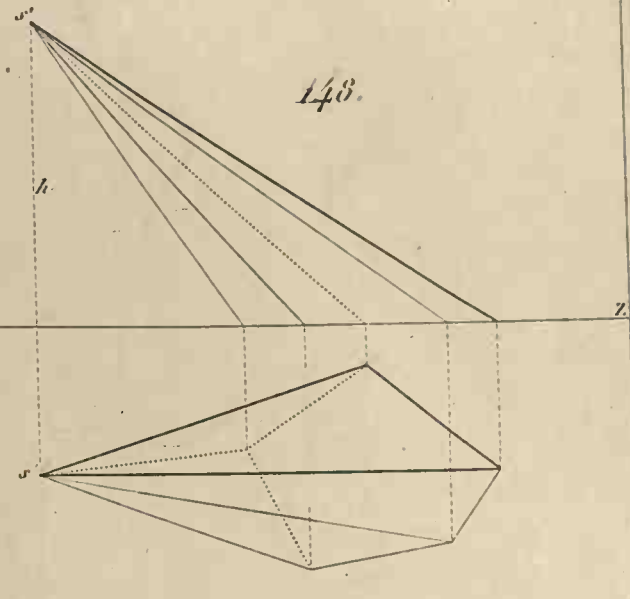

149

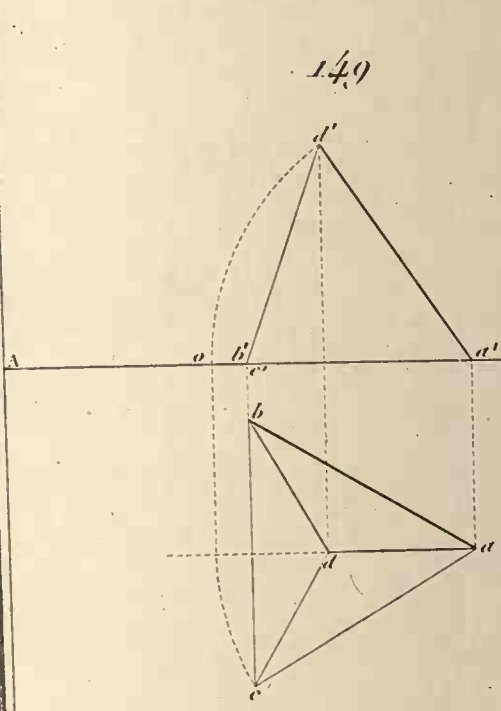

150

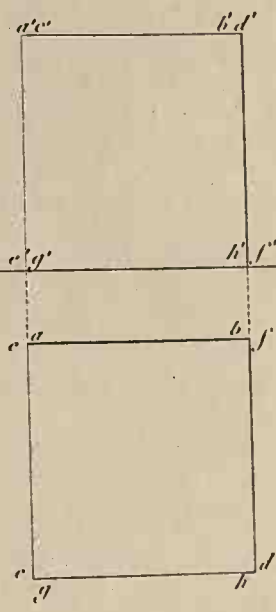

151

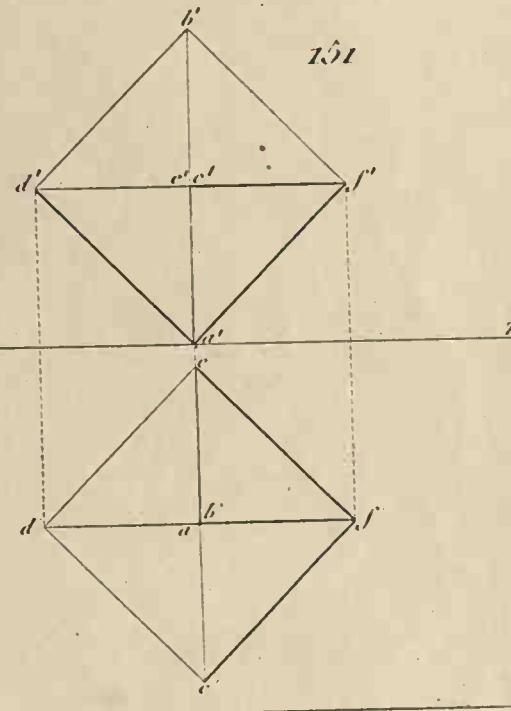

152

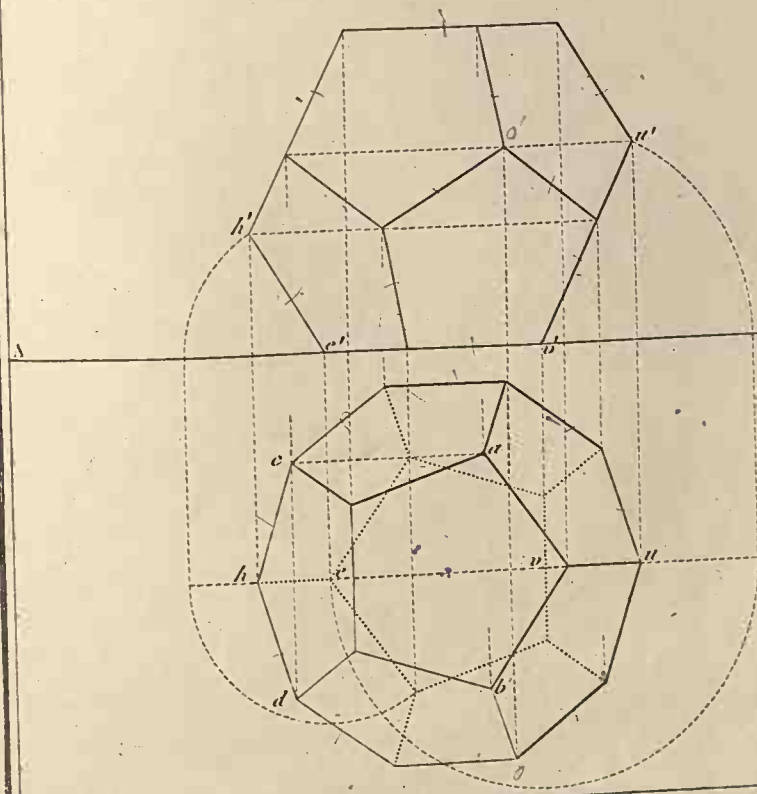

153

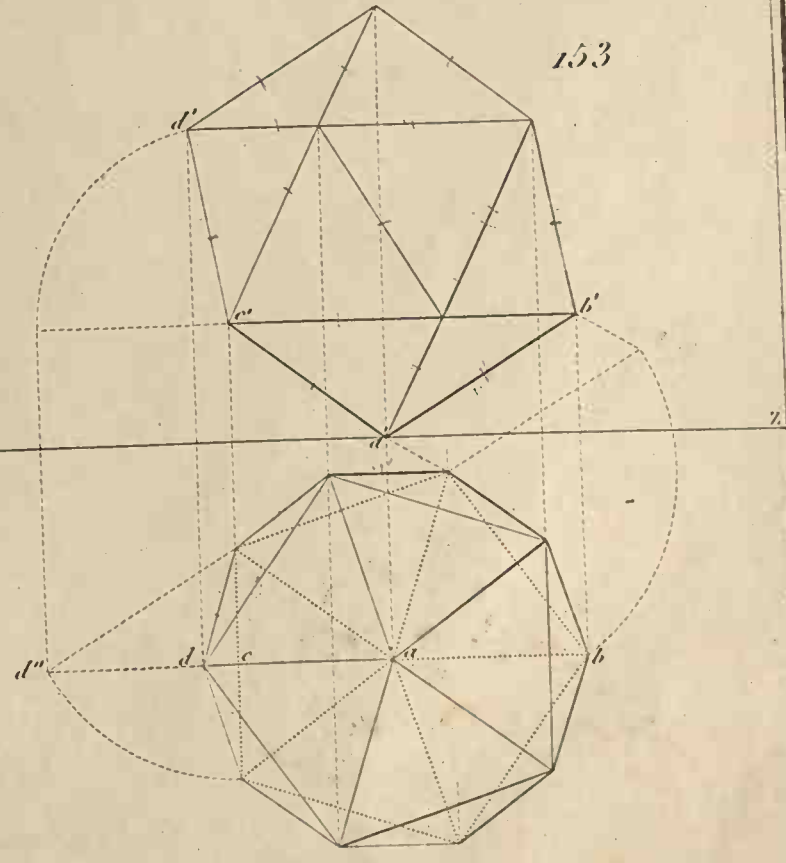

164

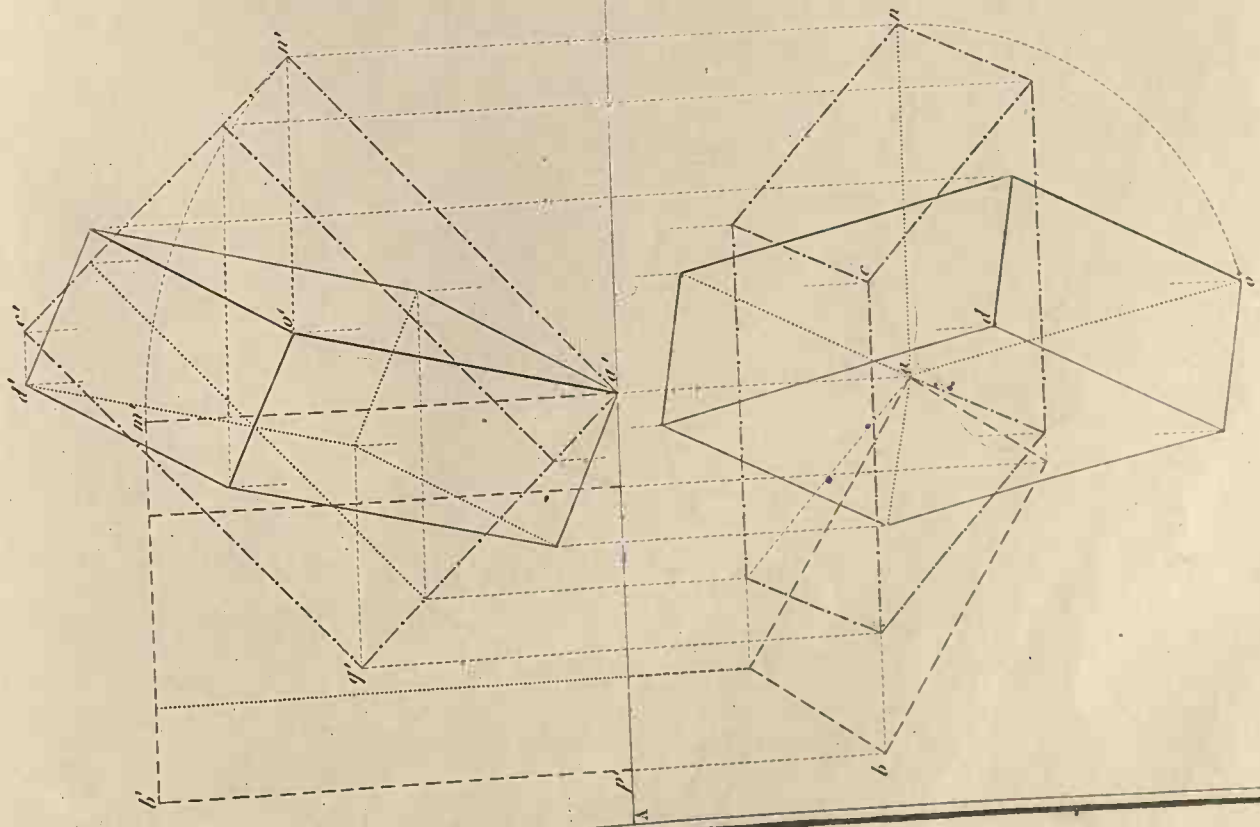

165

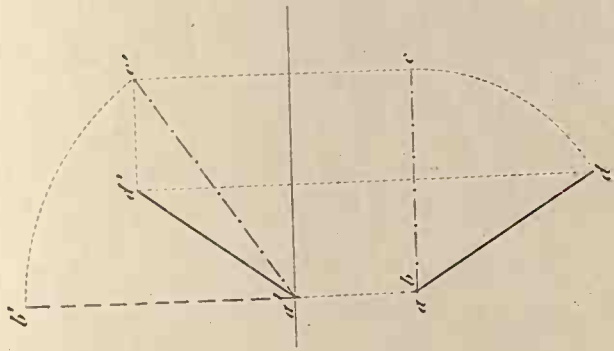

166

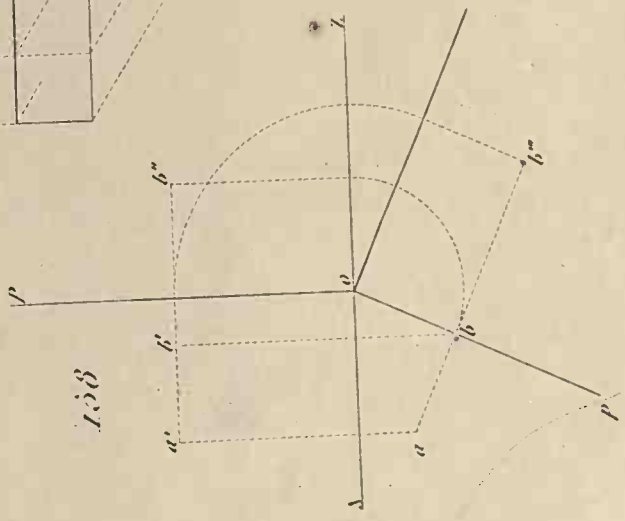

167

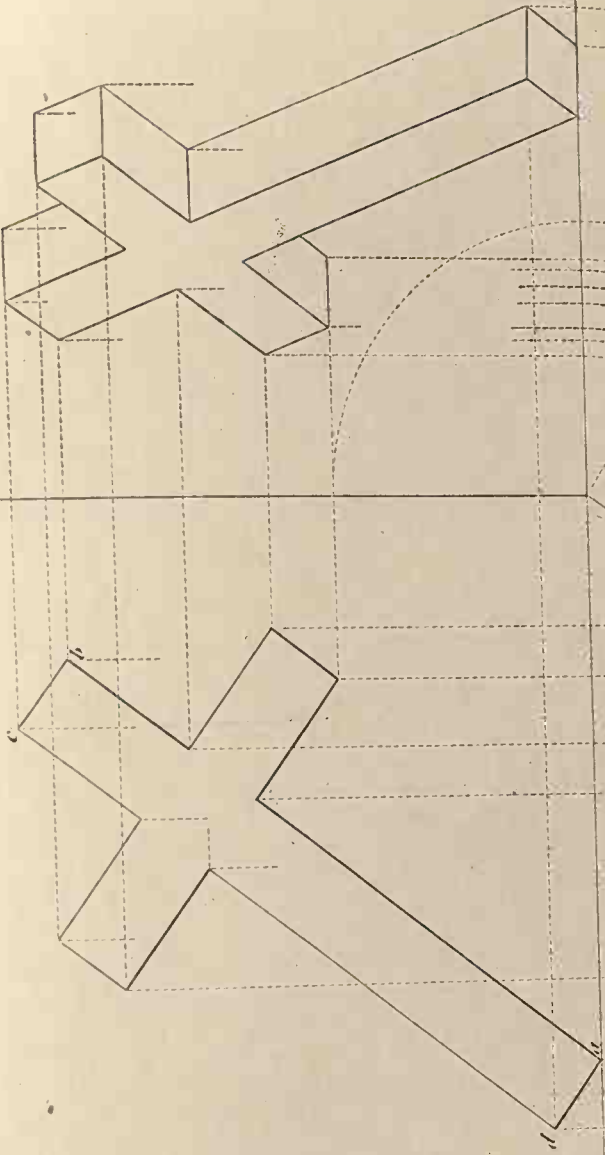

169

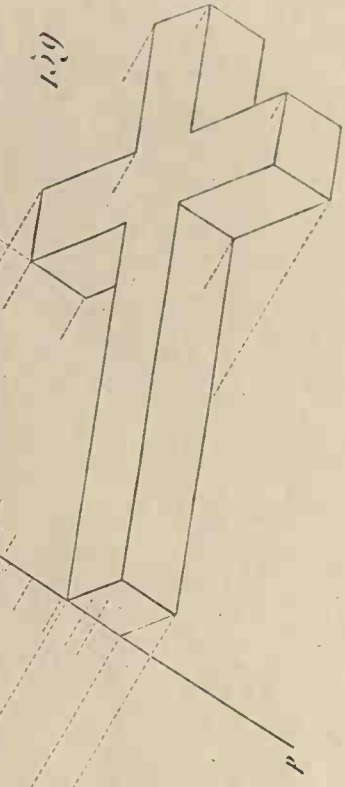

Geométrie descriptive.

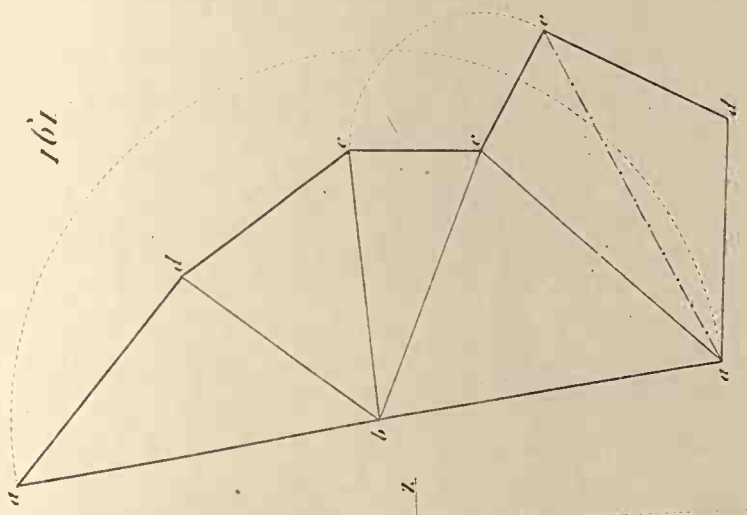
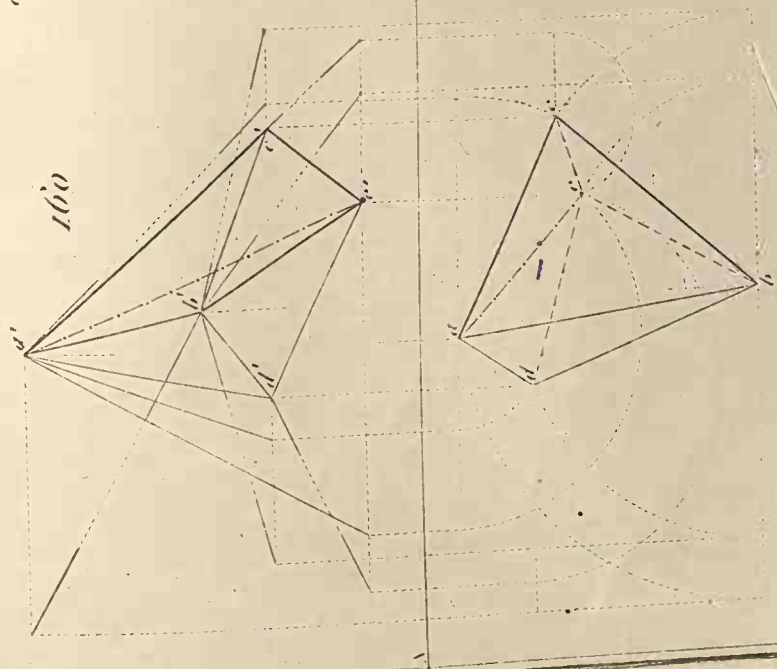

163

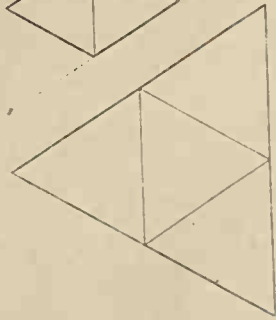

164

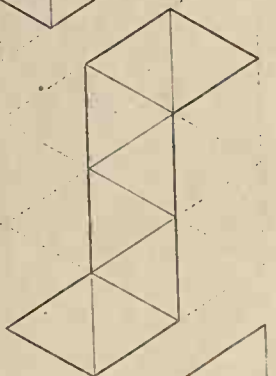

165

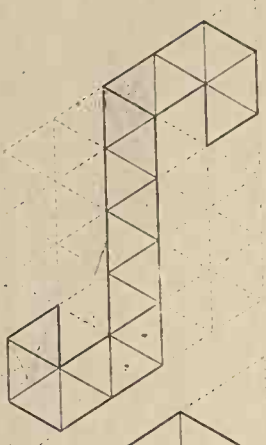

166



167

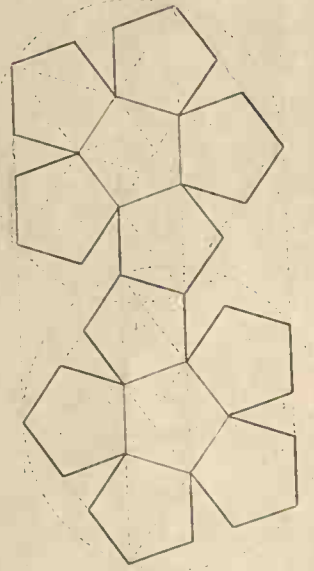

162

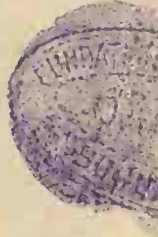
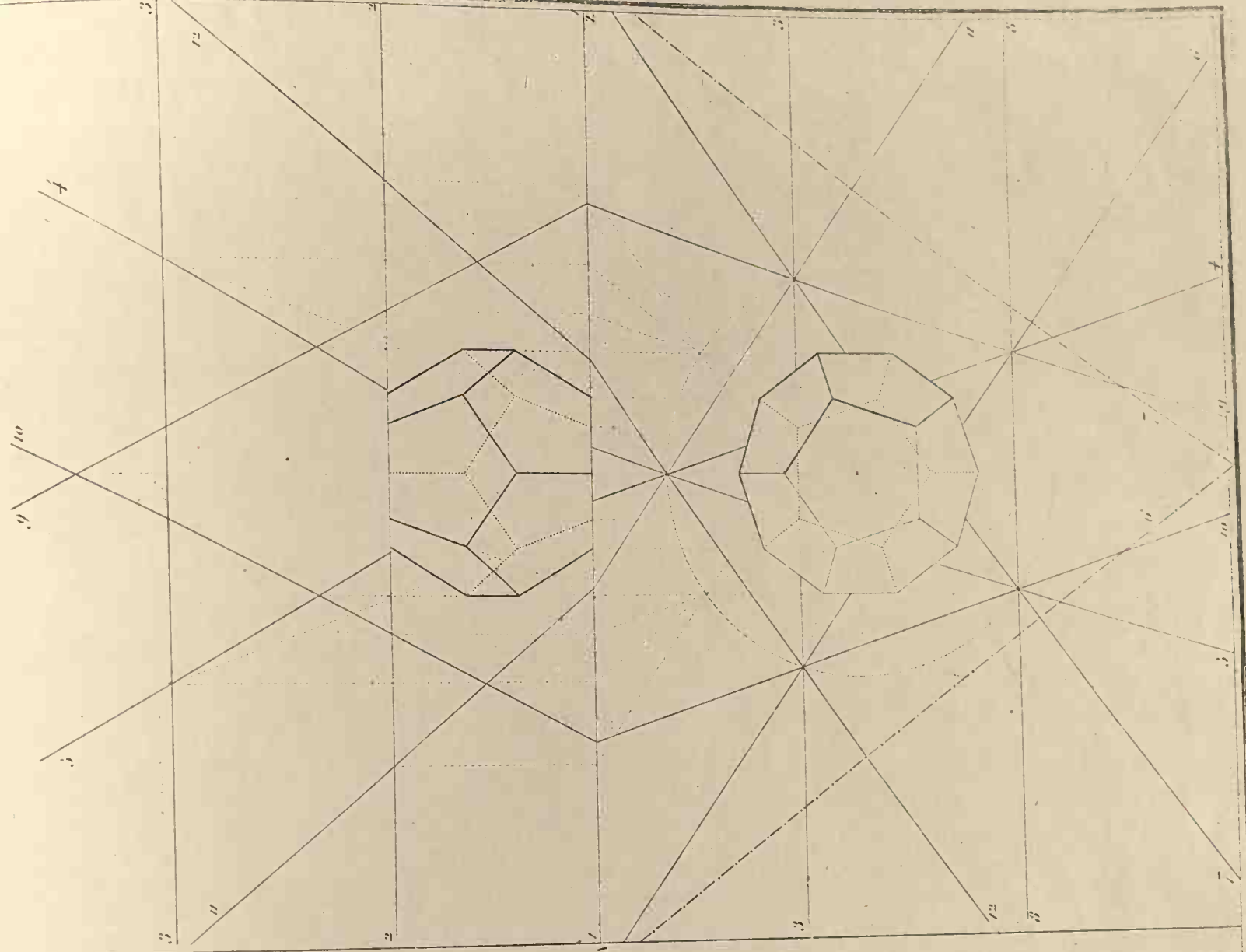

168

169

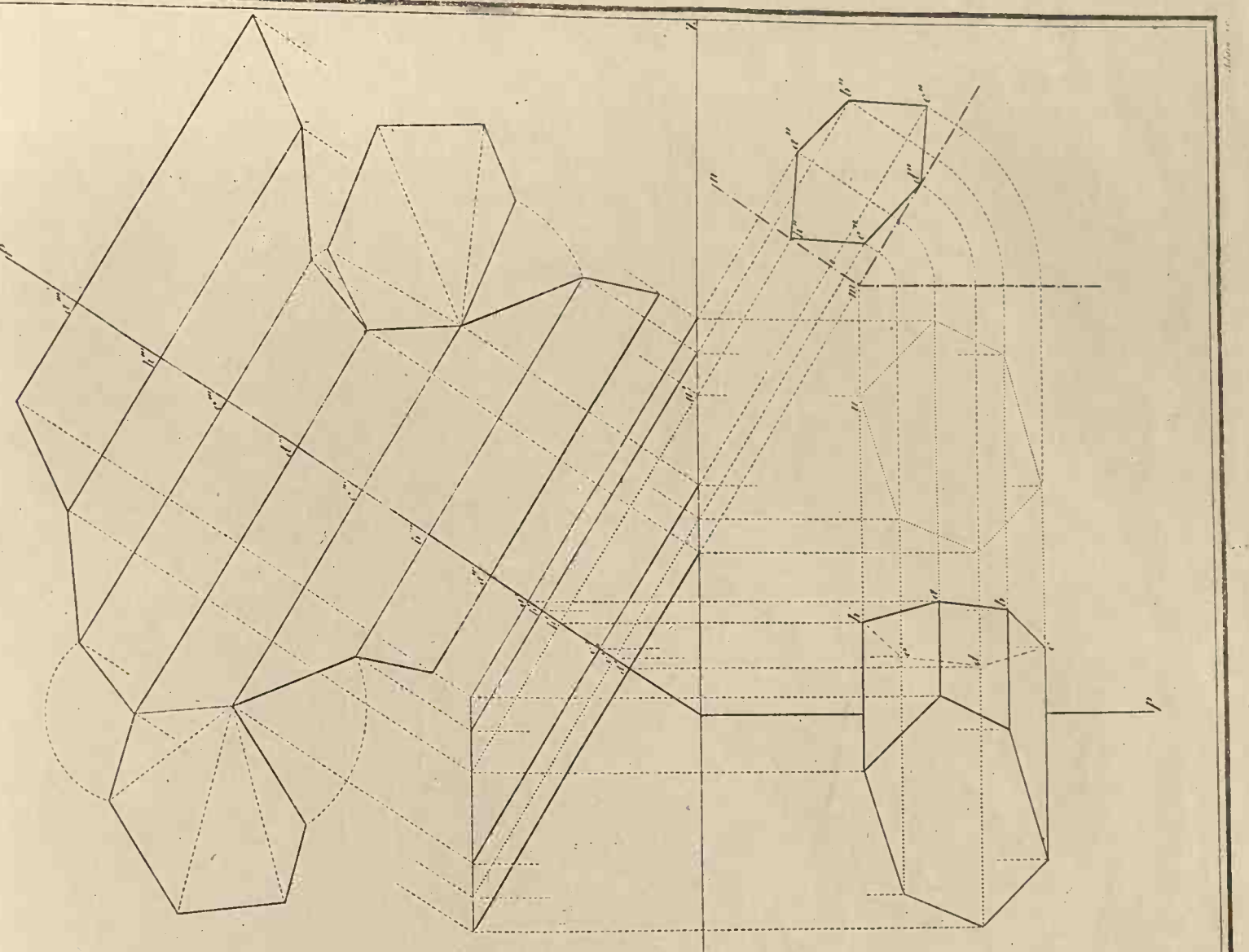
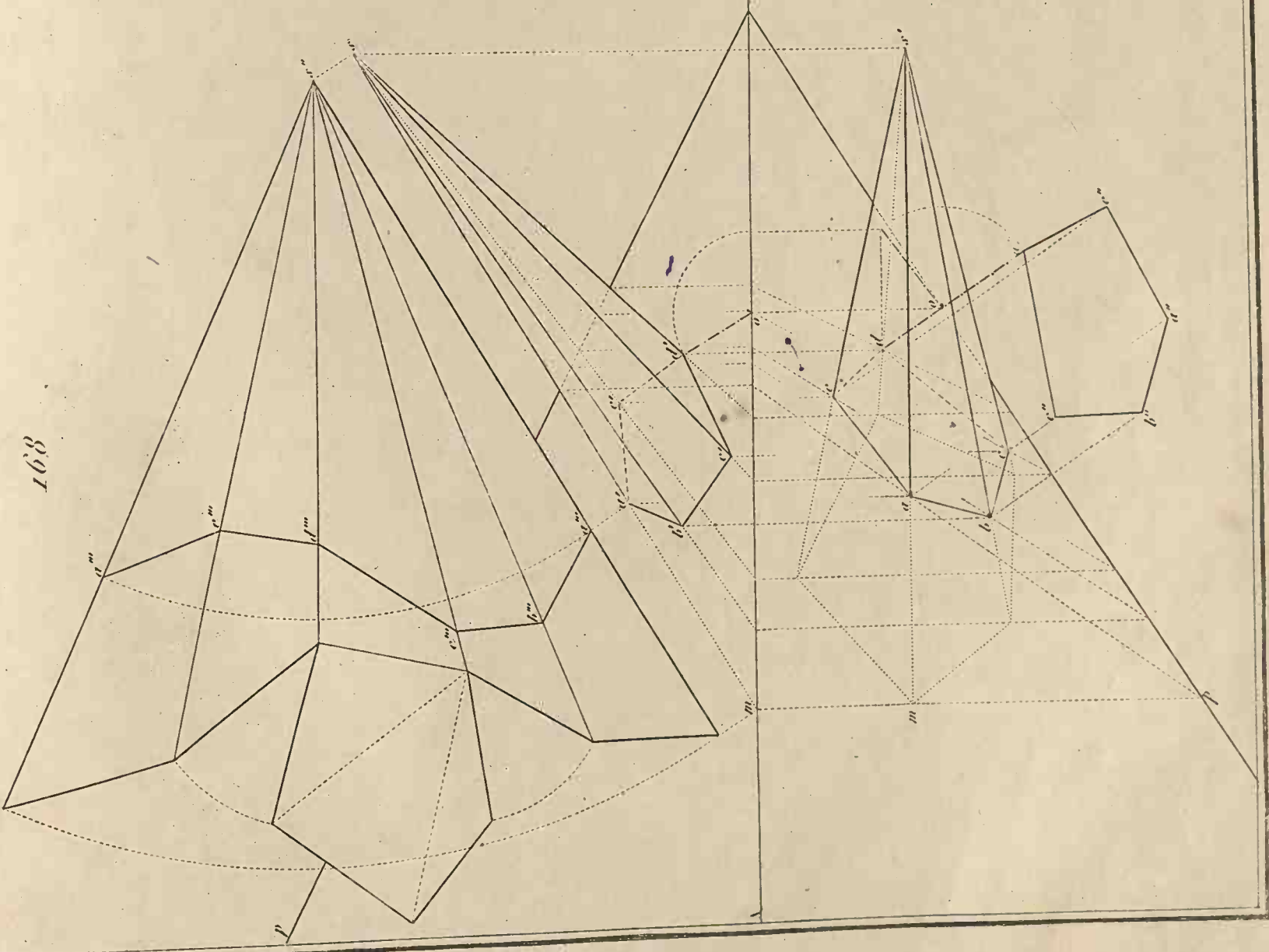

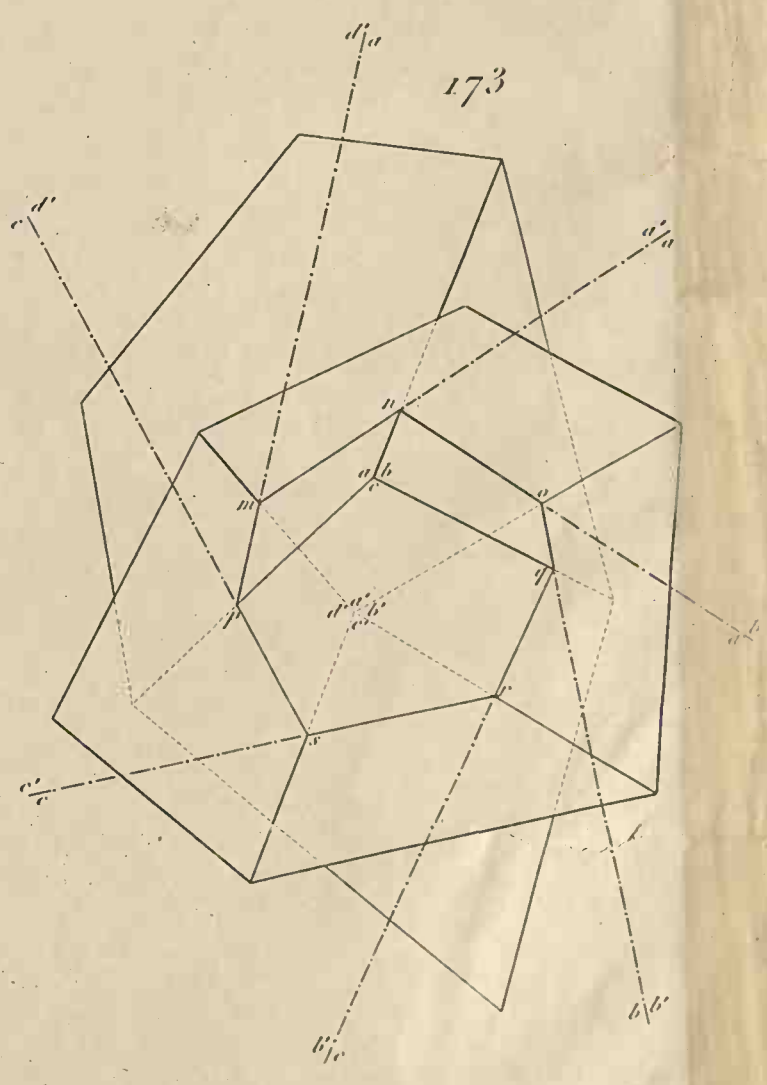
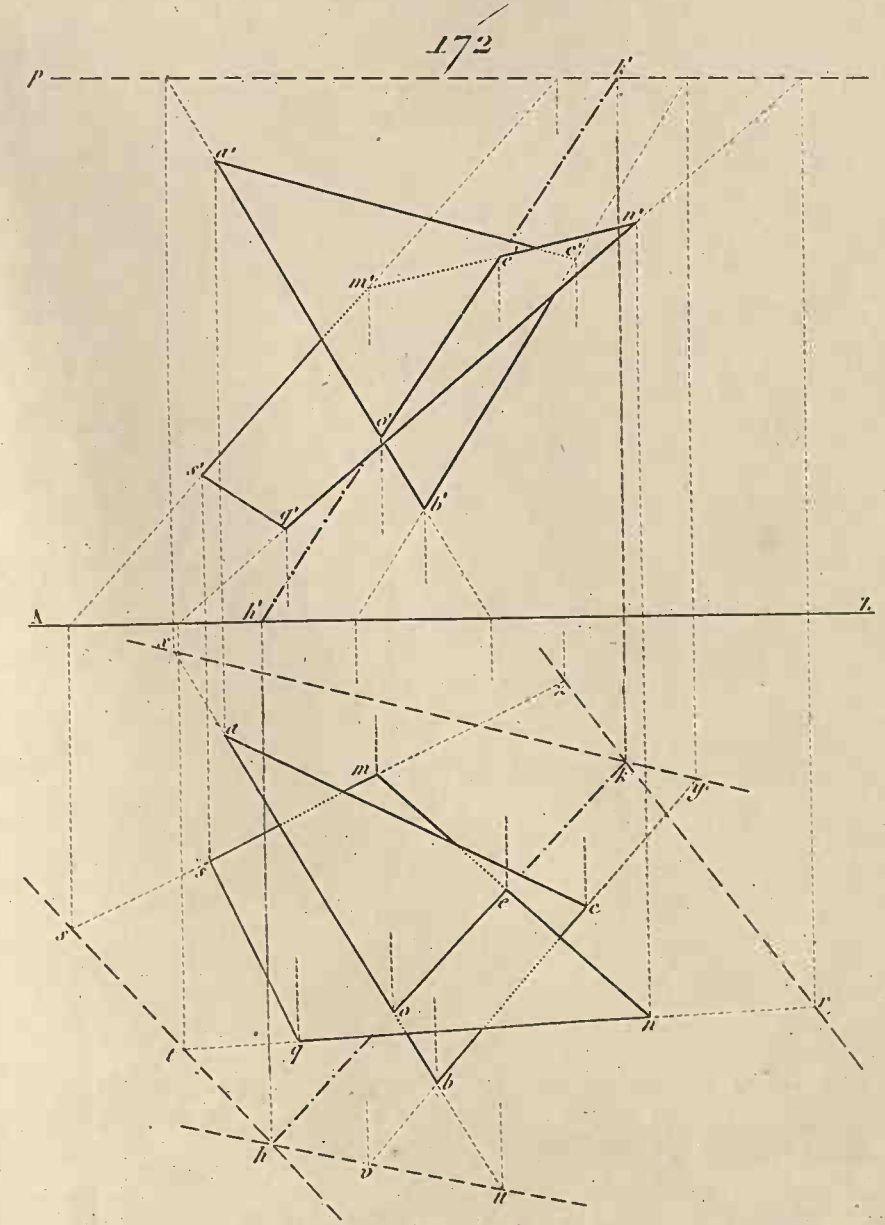
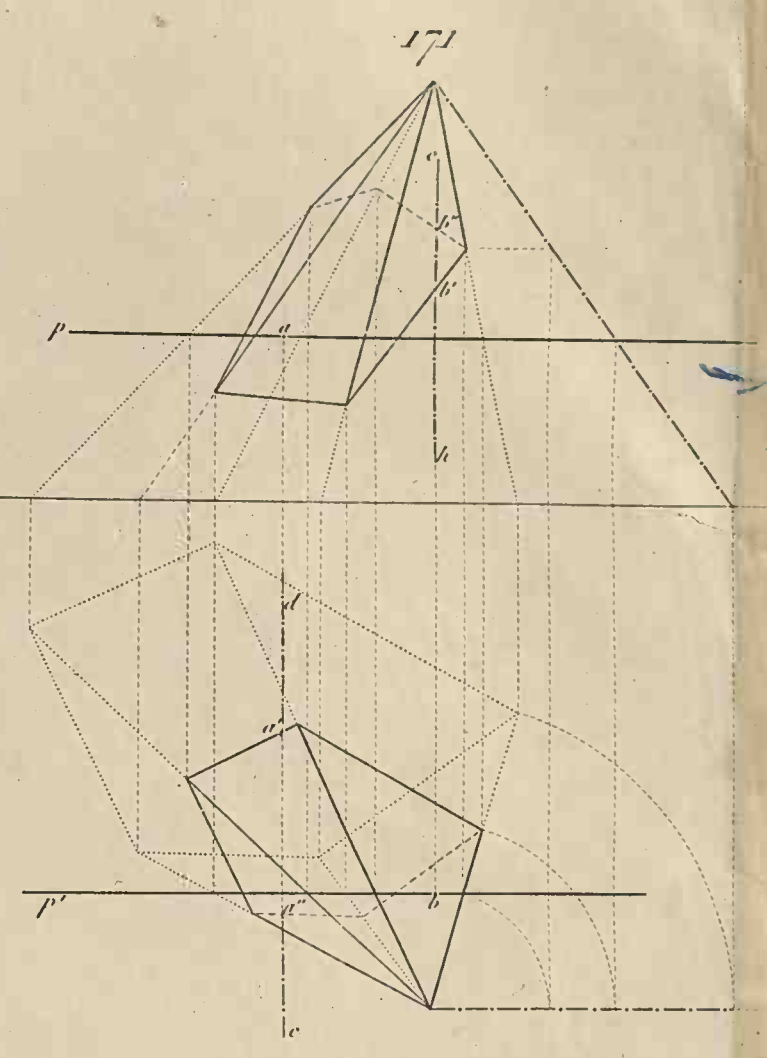
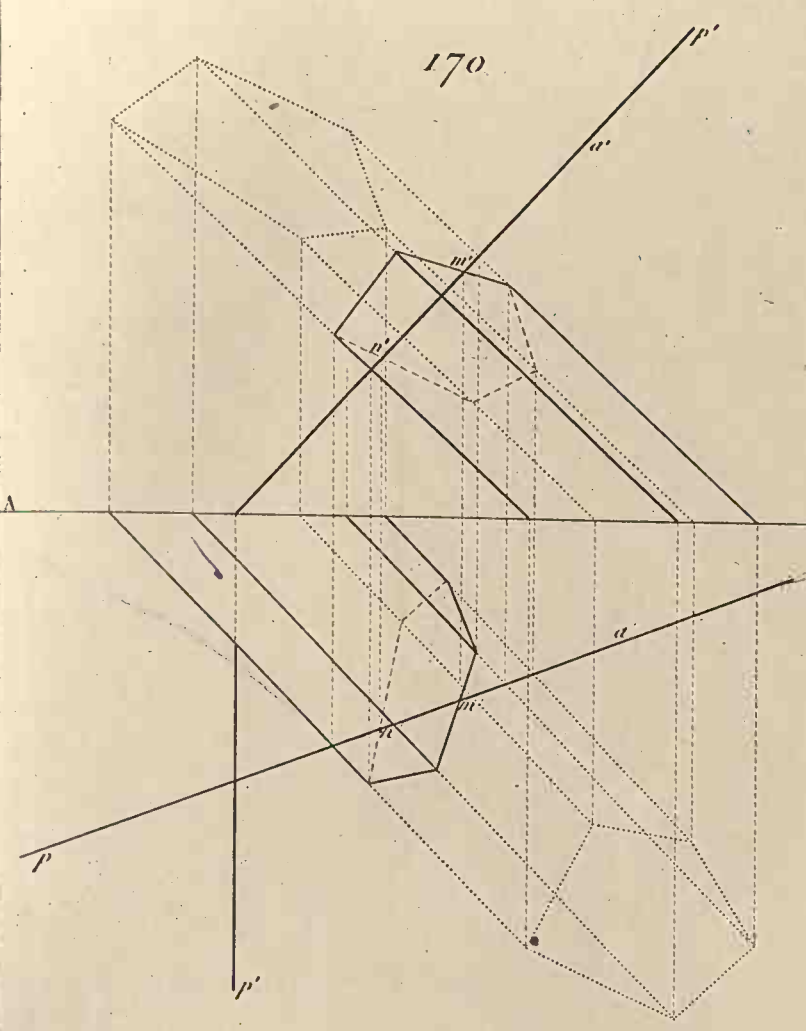

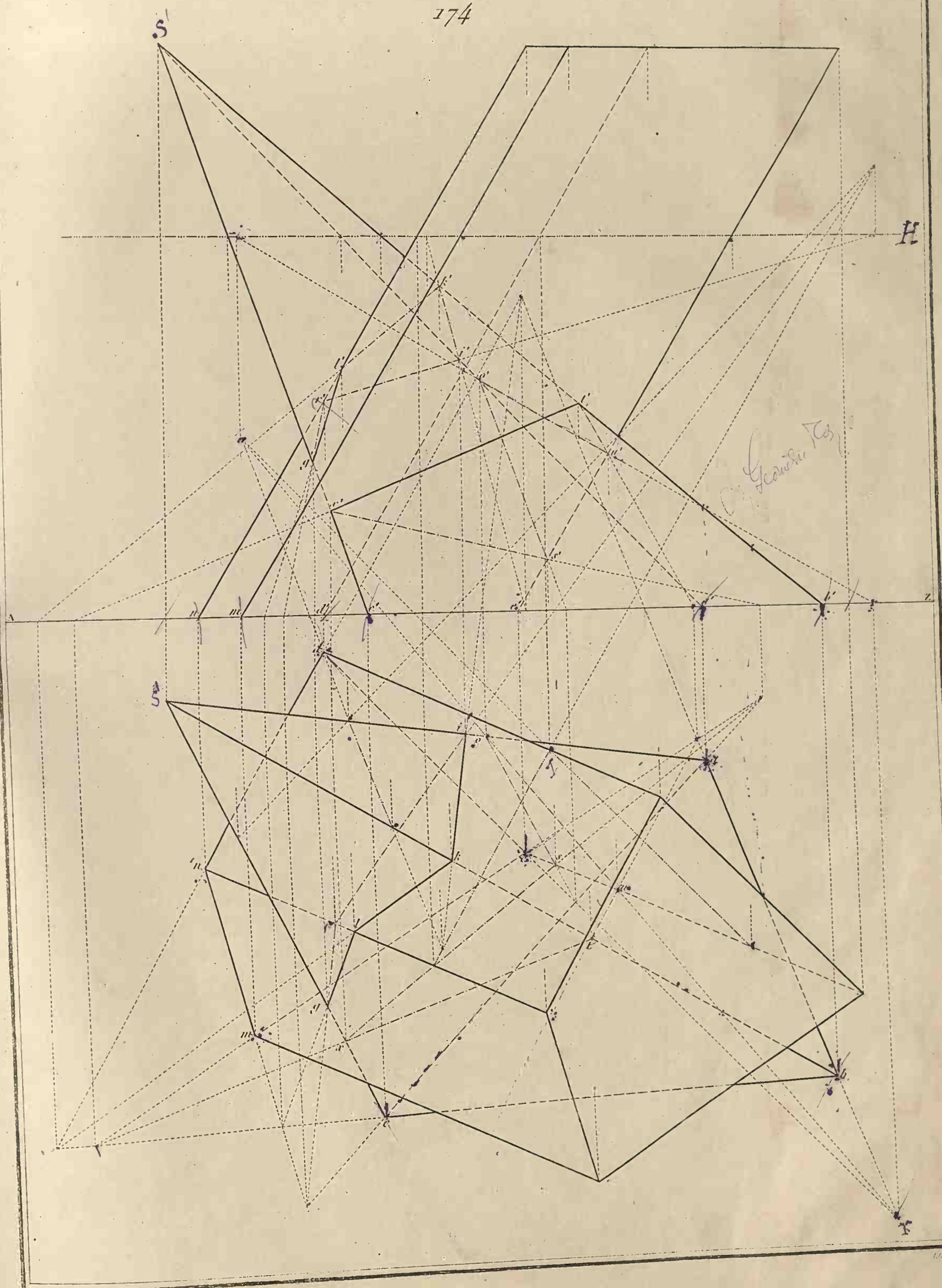

de la Géométrie Descartes

175

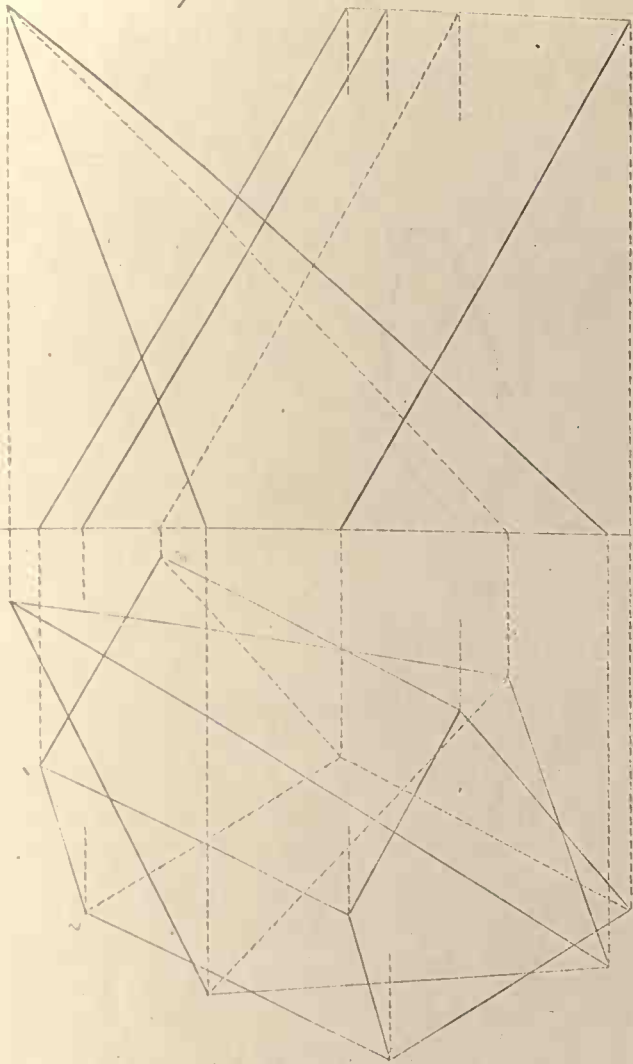

176

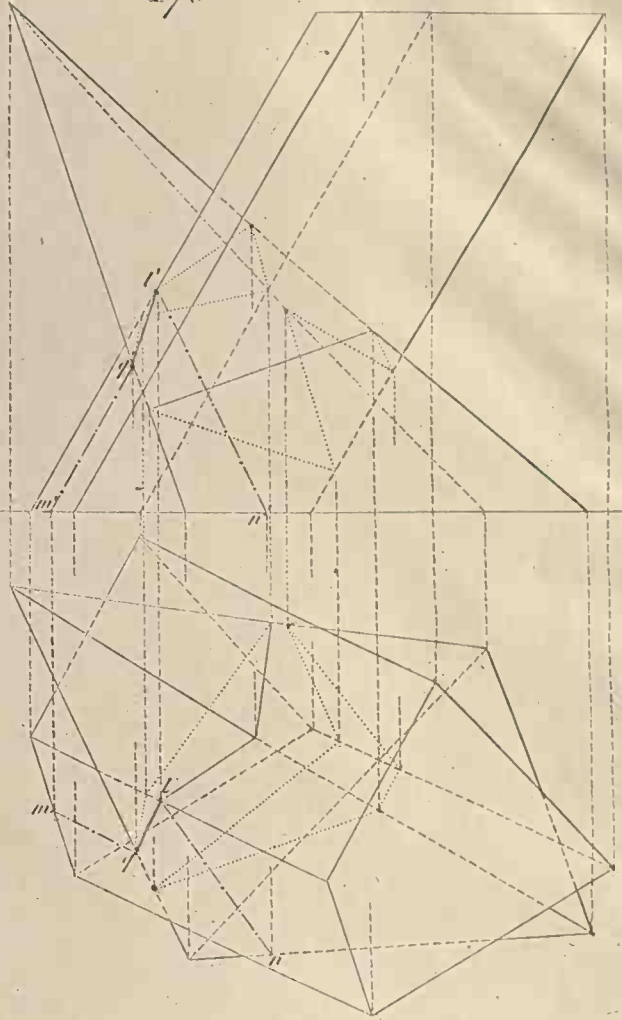

177

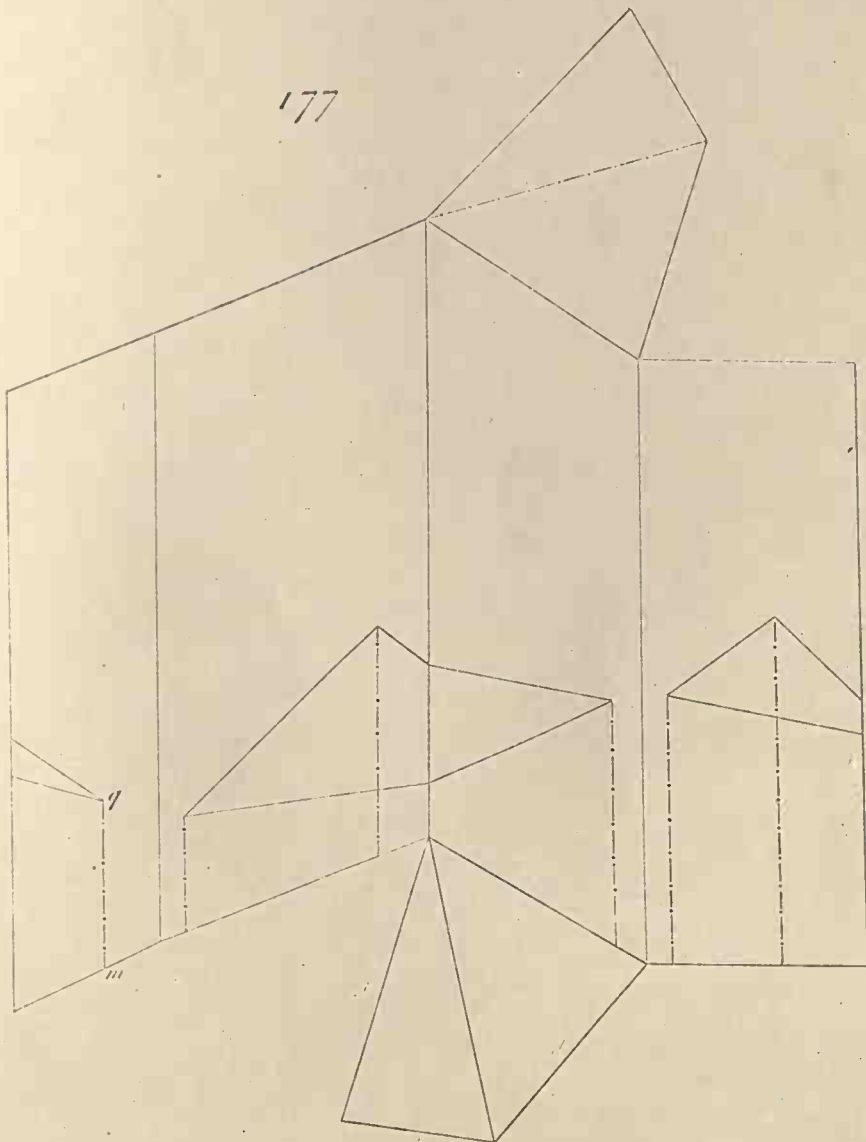

178

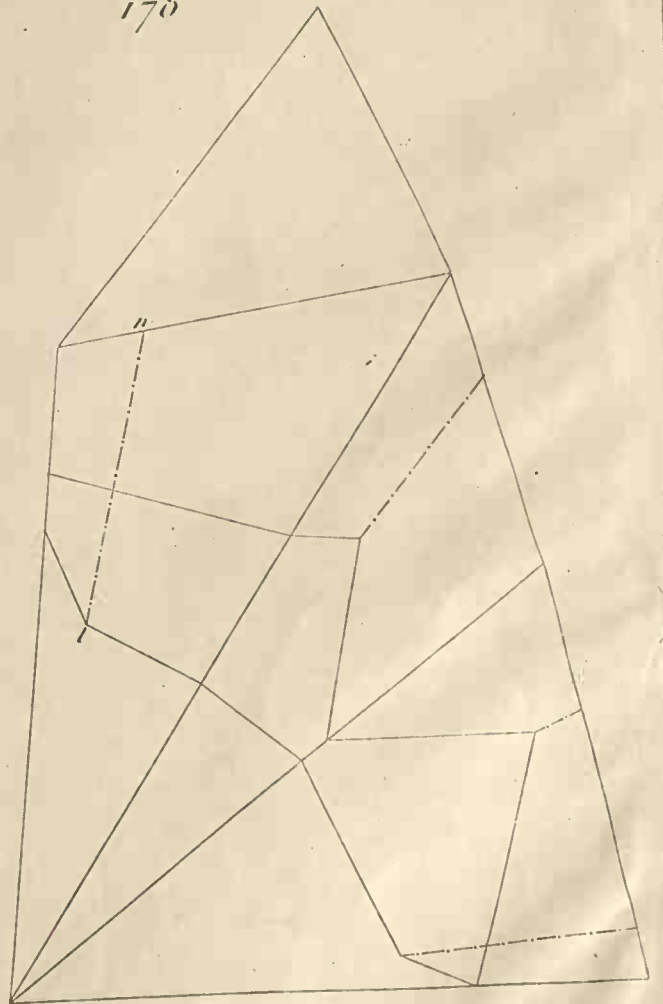

17

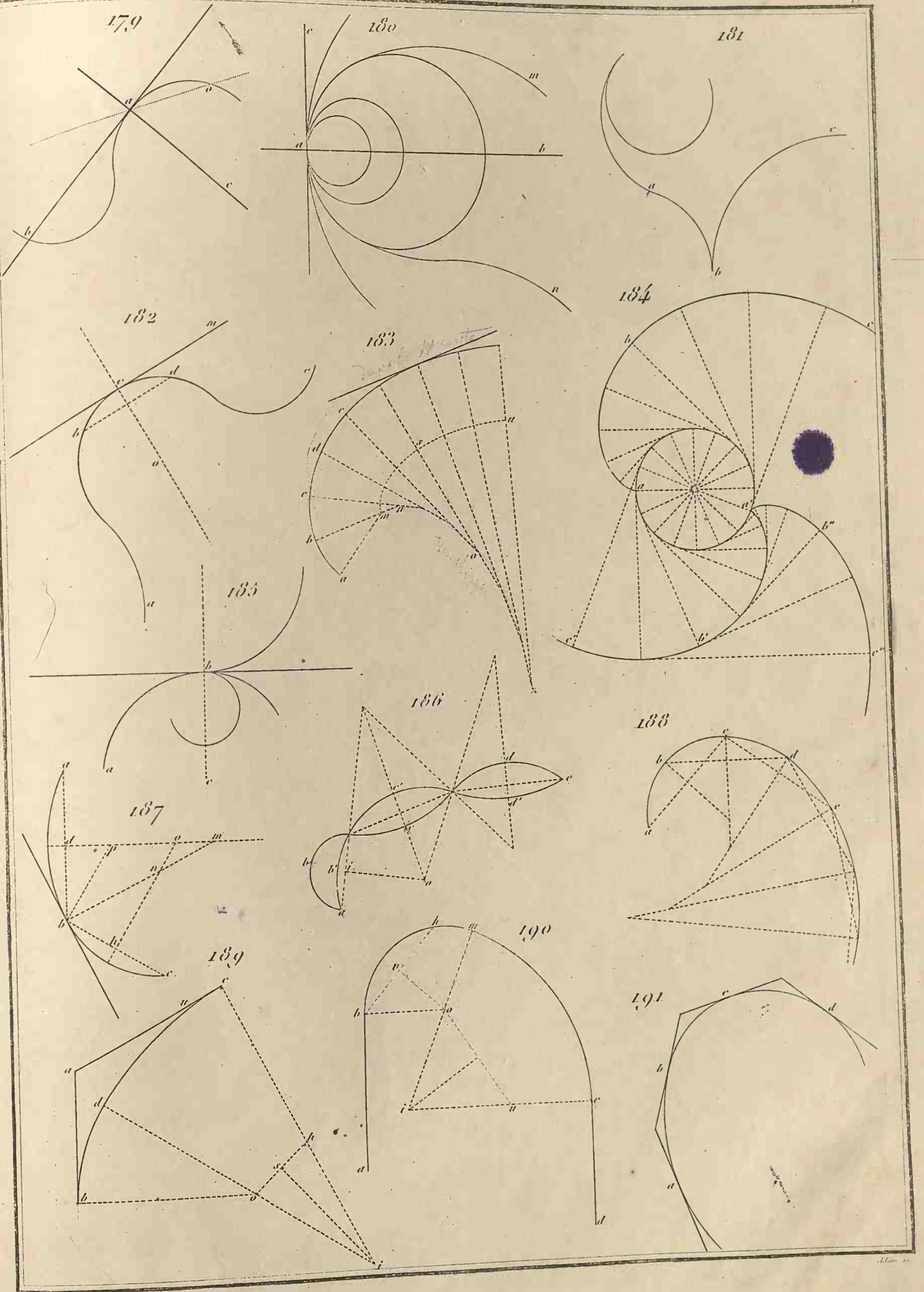

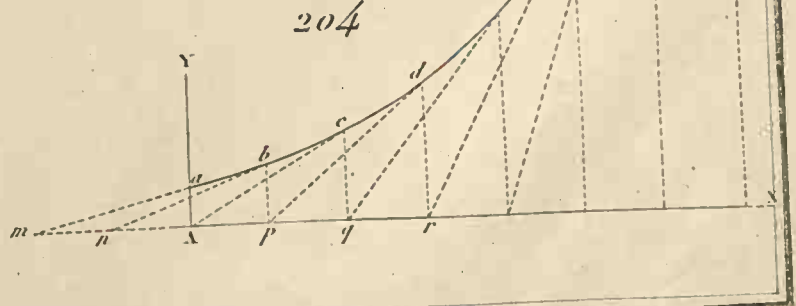
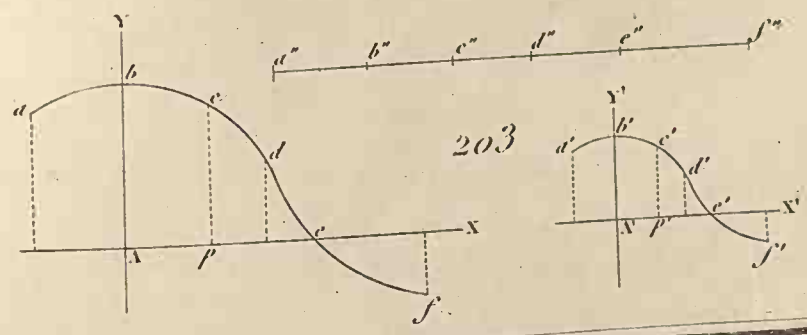
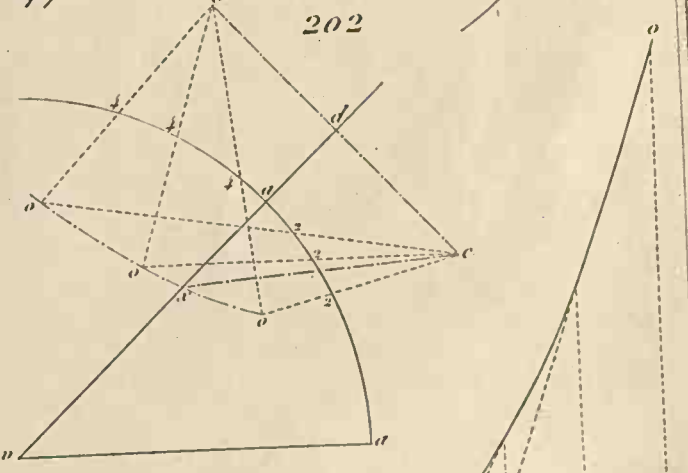
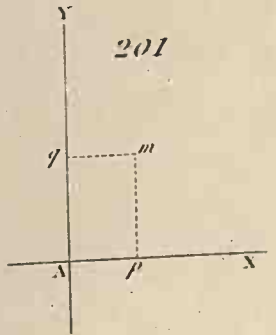
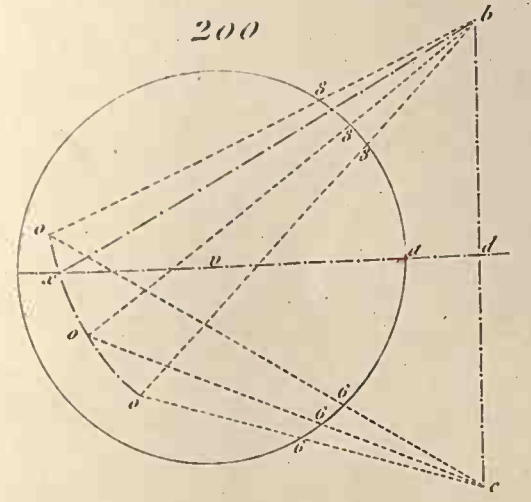
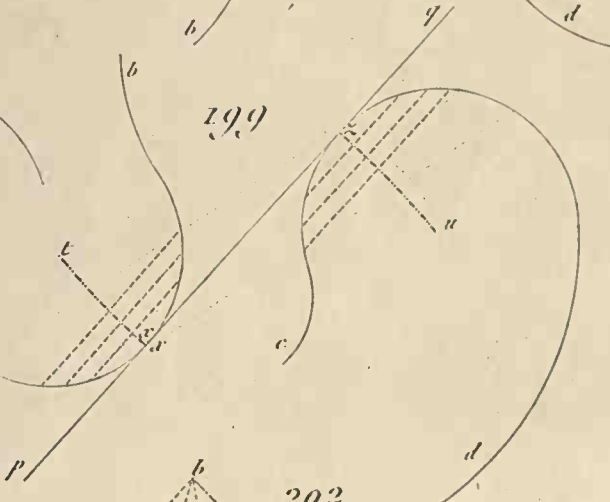
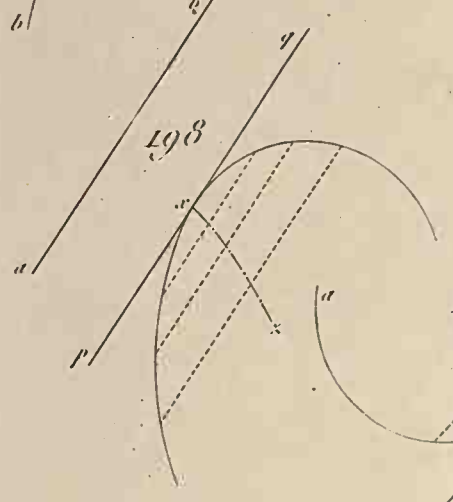
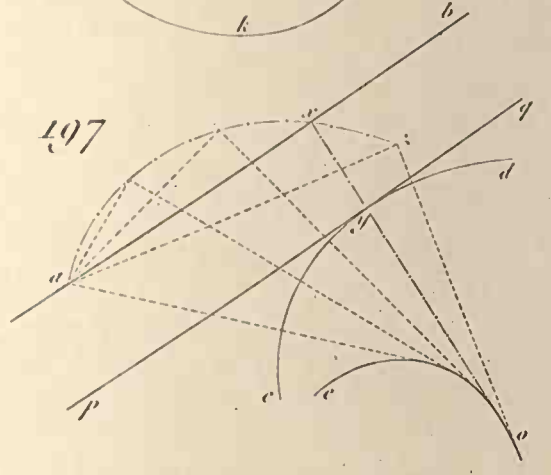
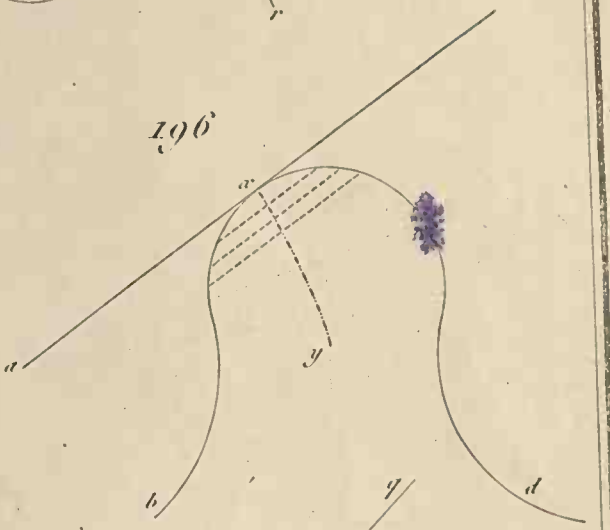
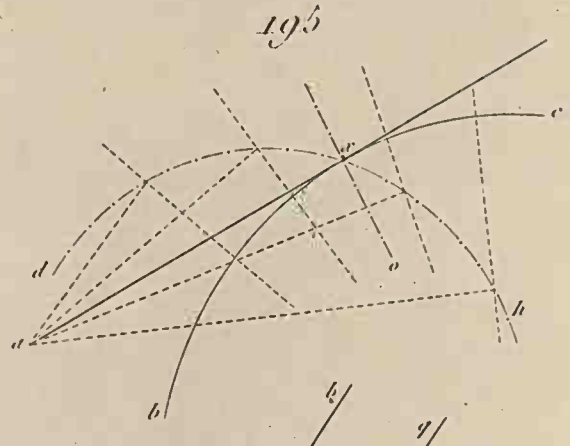
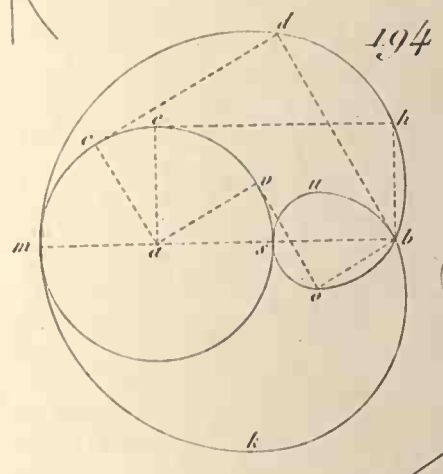
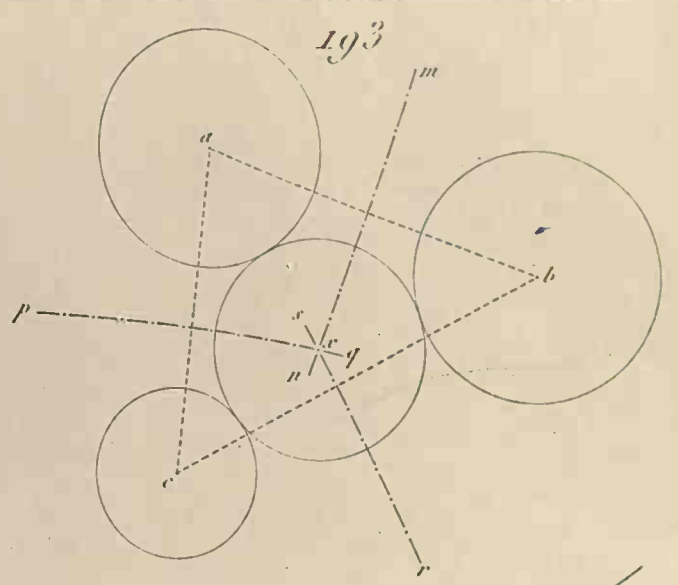
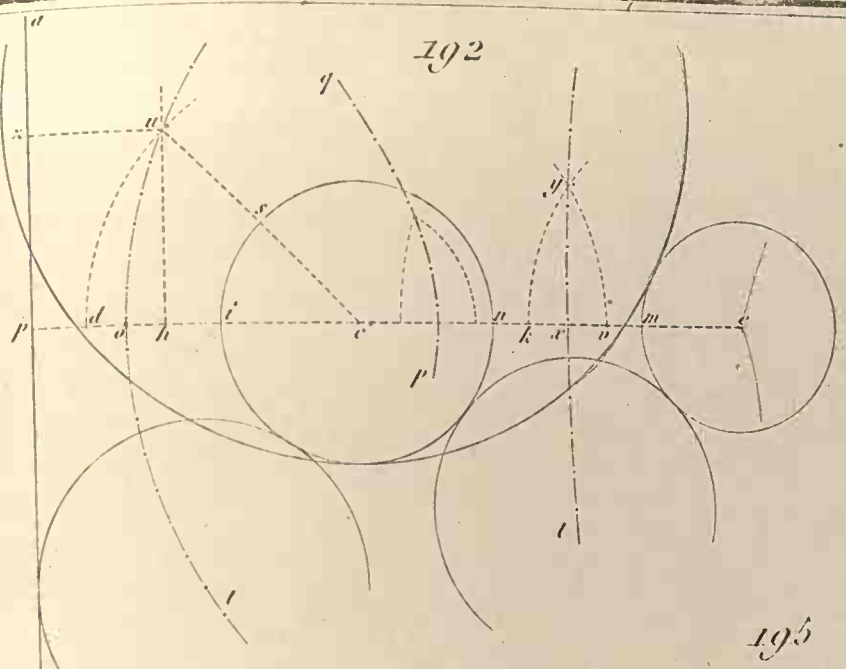

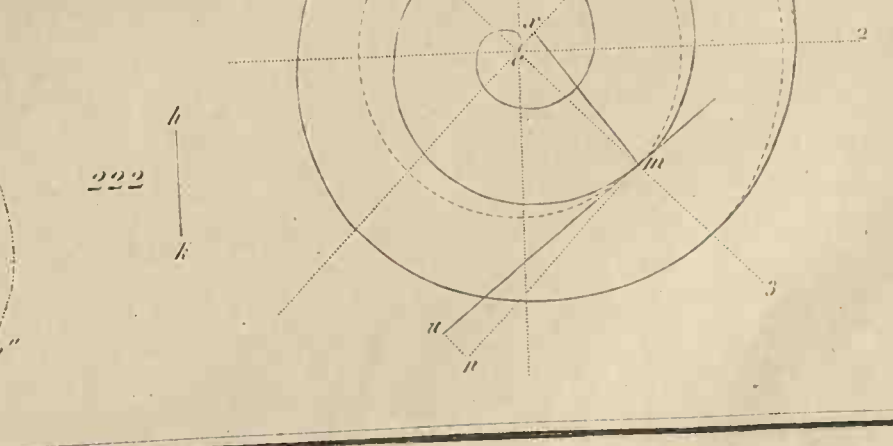
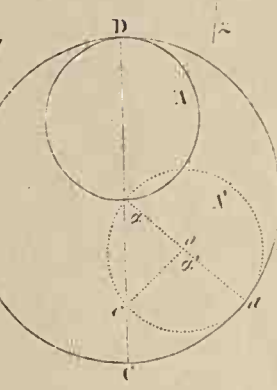
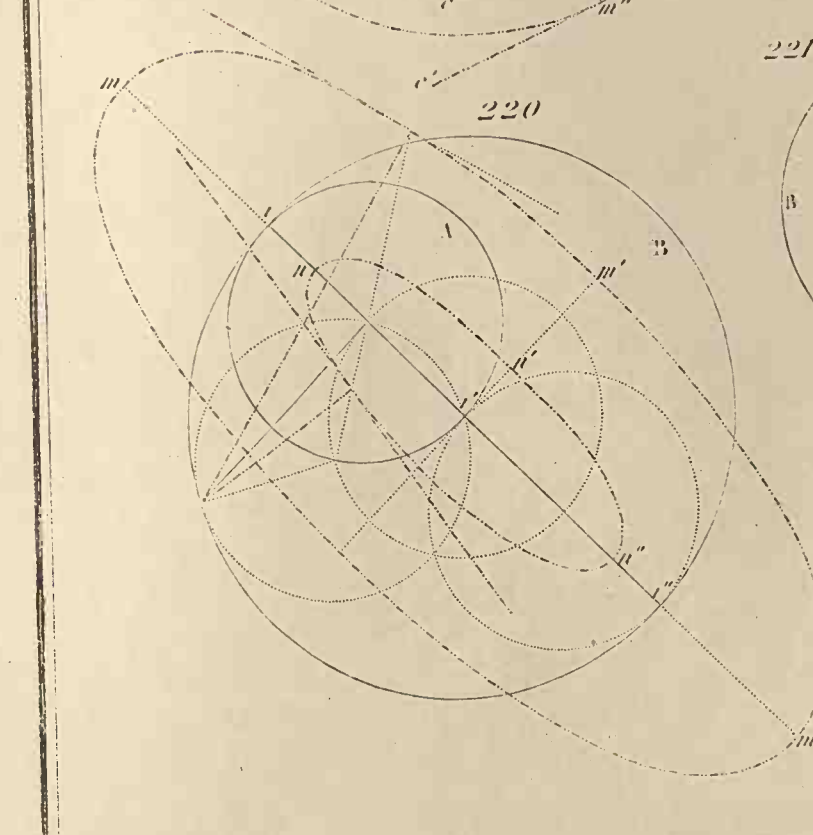
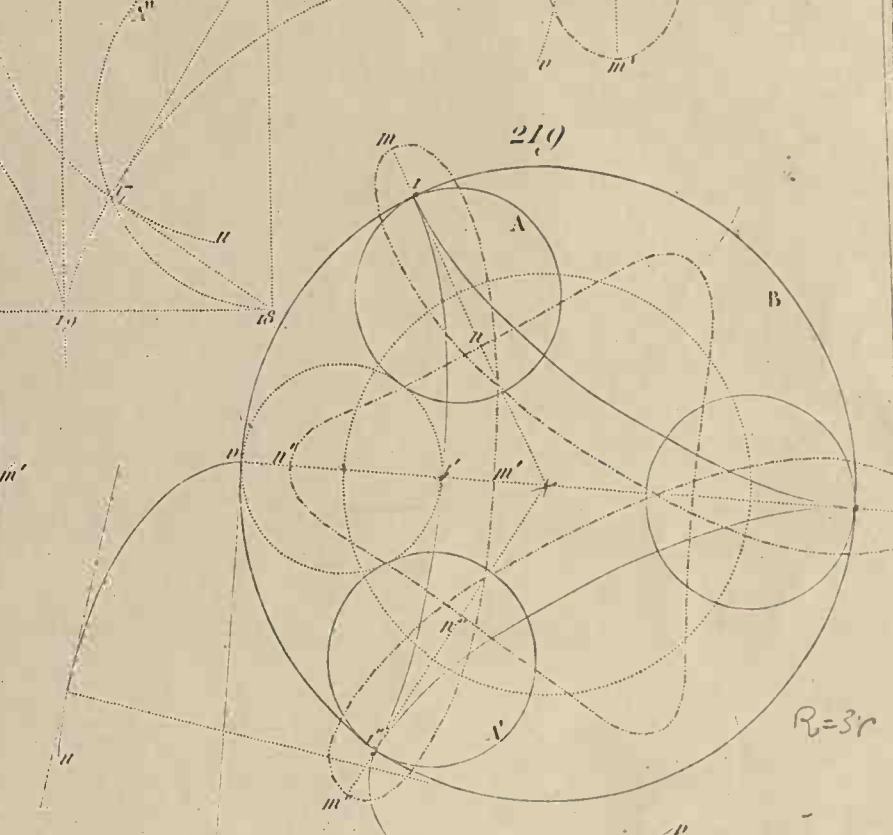
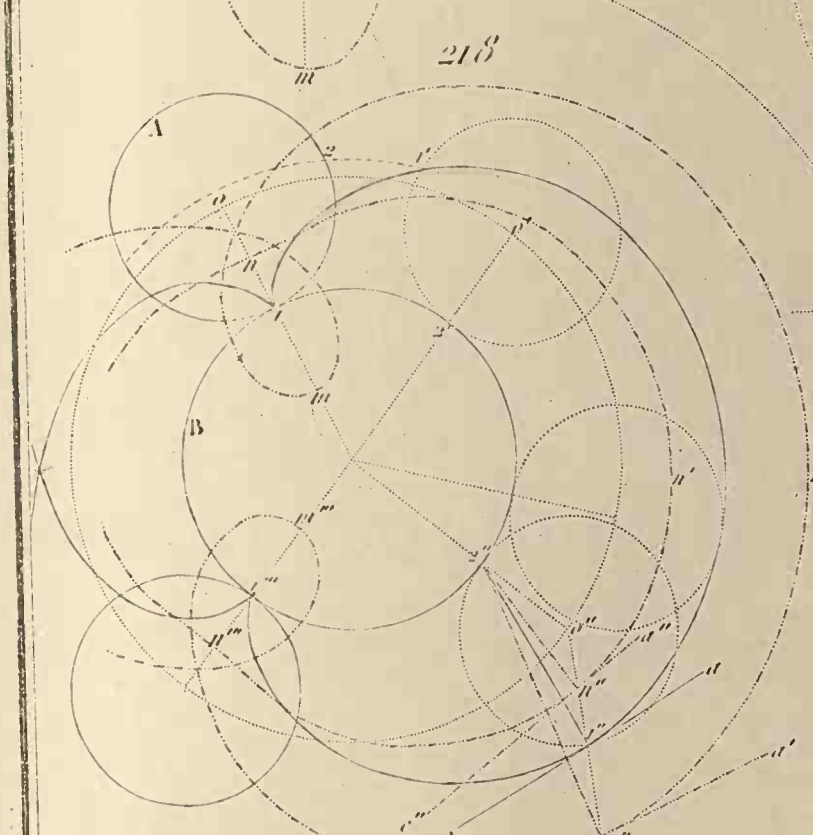
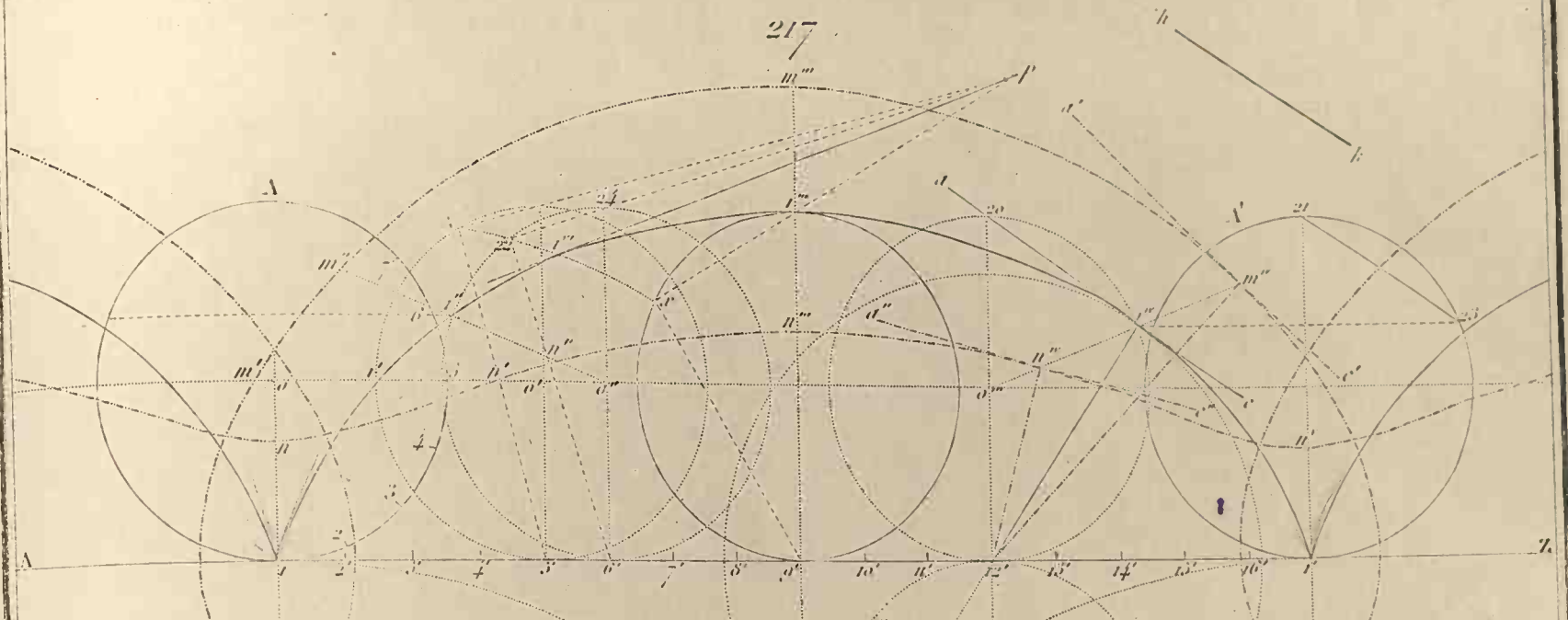

205

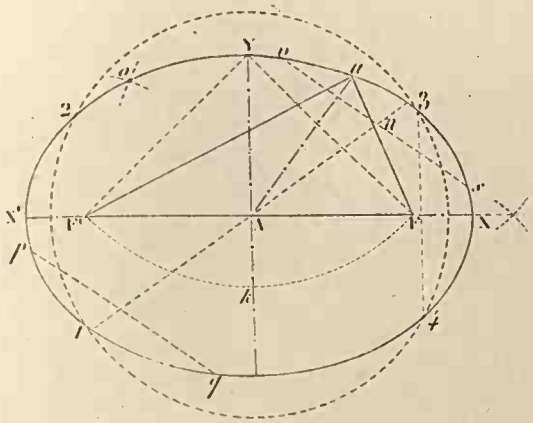

206

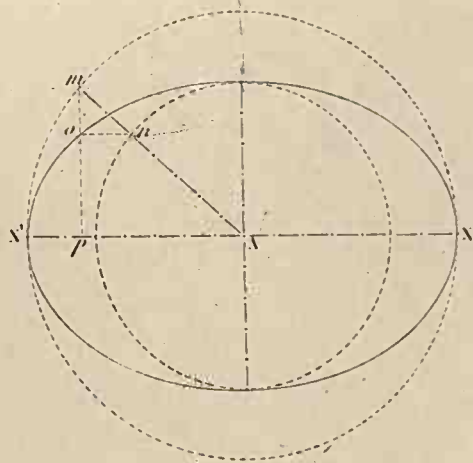

207

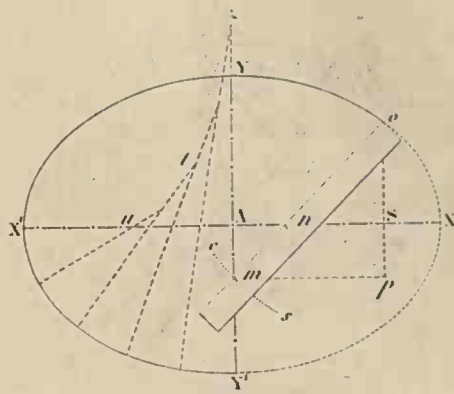

208

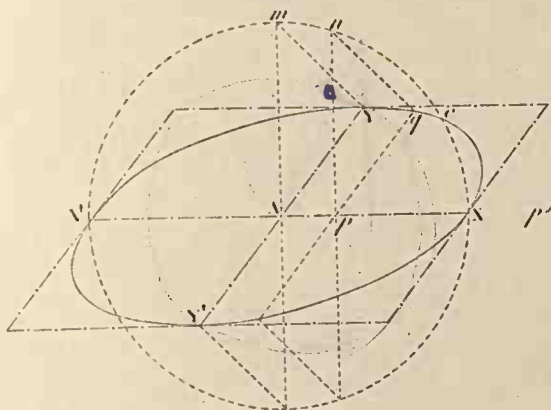

209

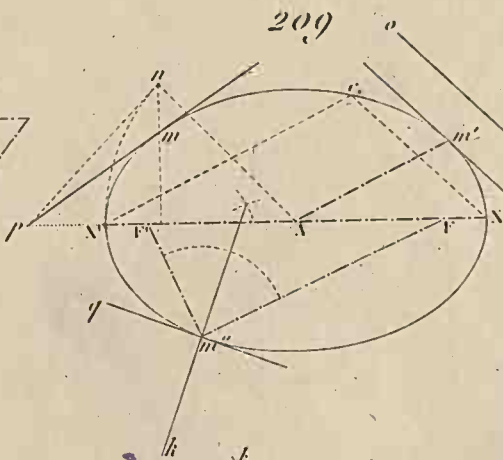

210

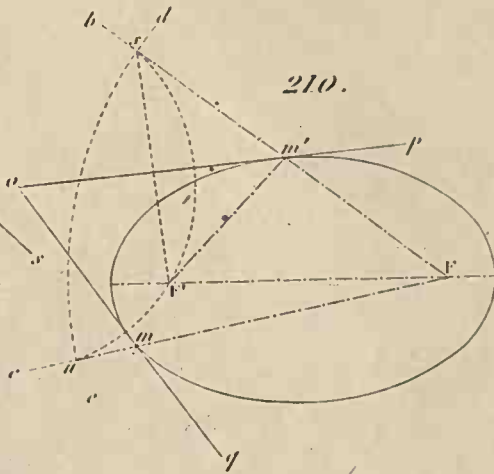

211

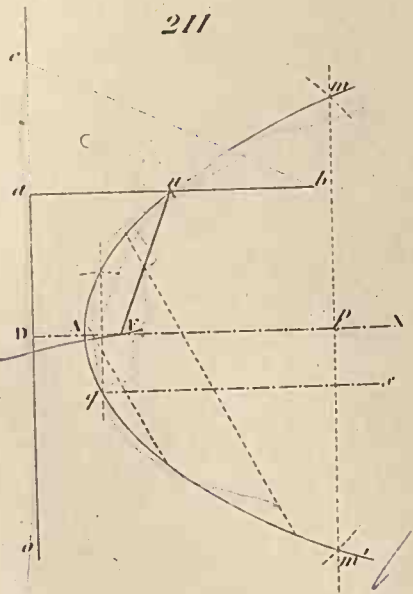

212

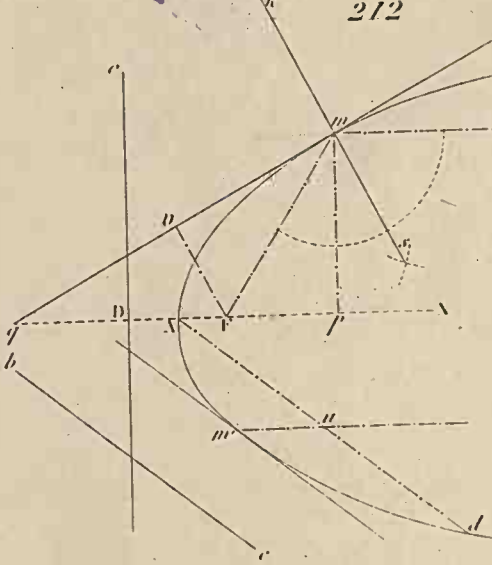

213

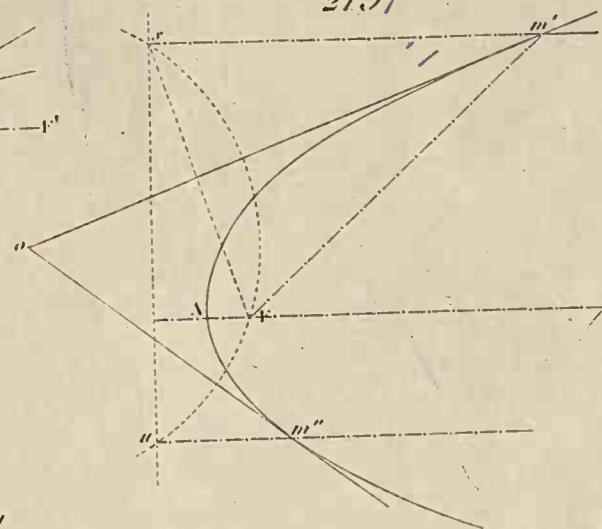

214

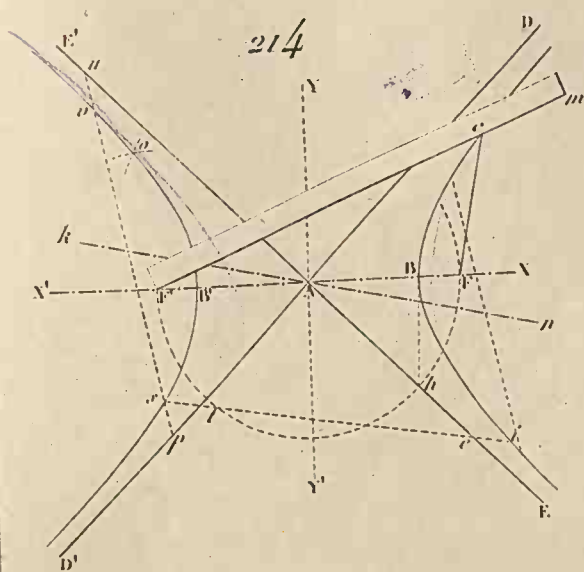

215

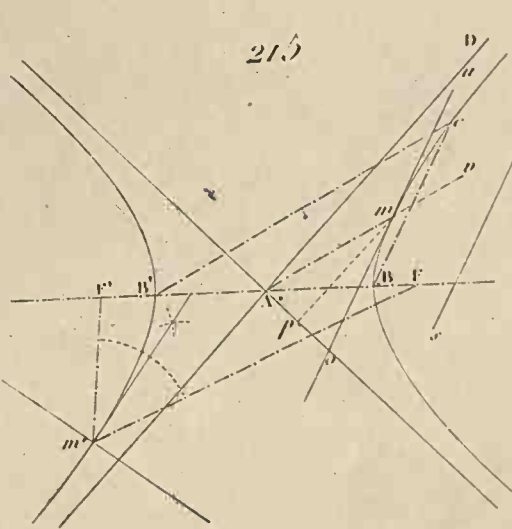

216

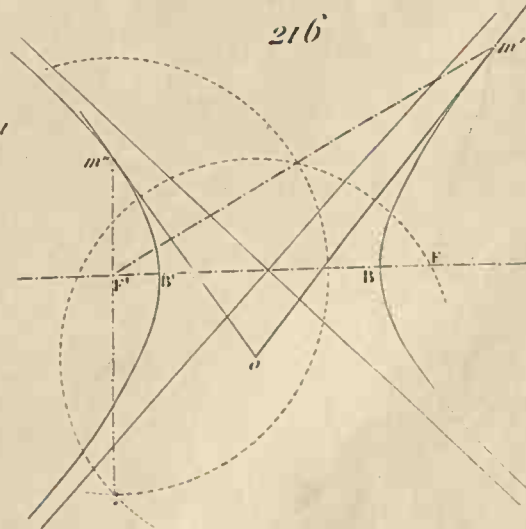

géométrie descriptive

Fig. 1.

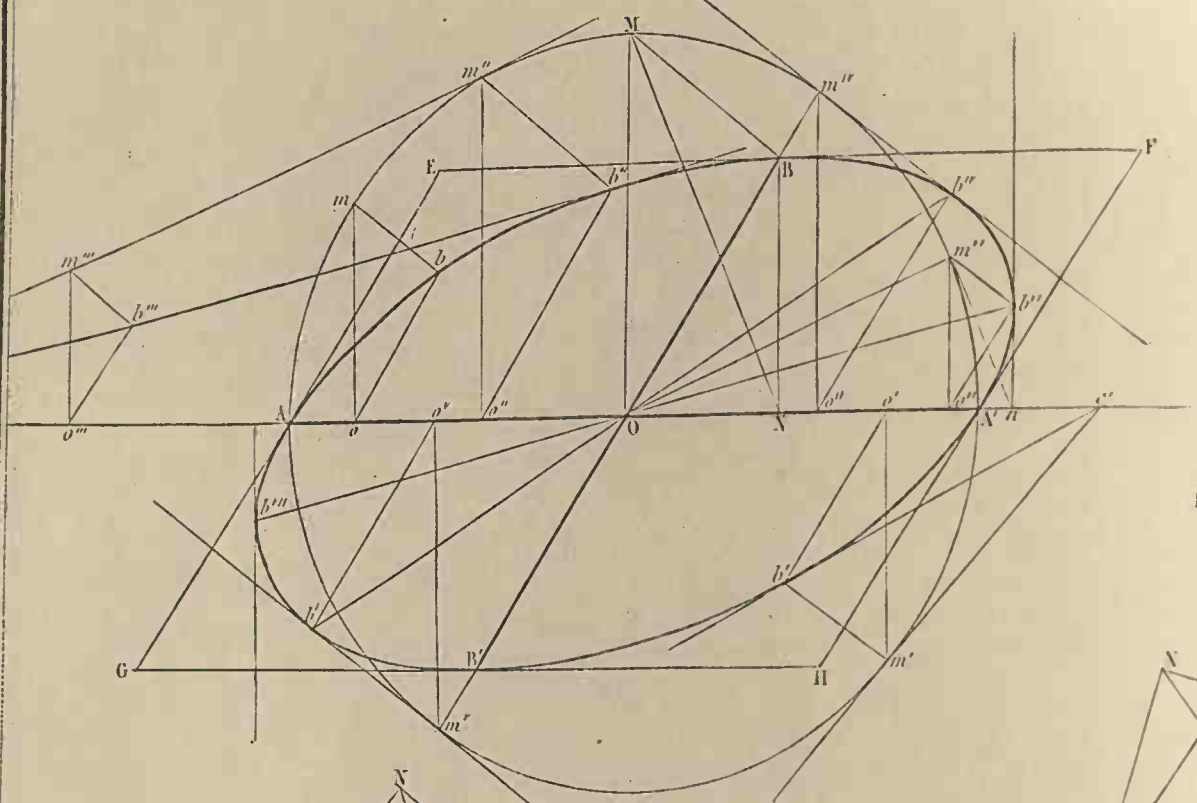

Fig. 2.

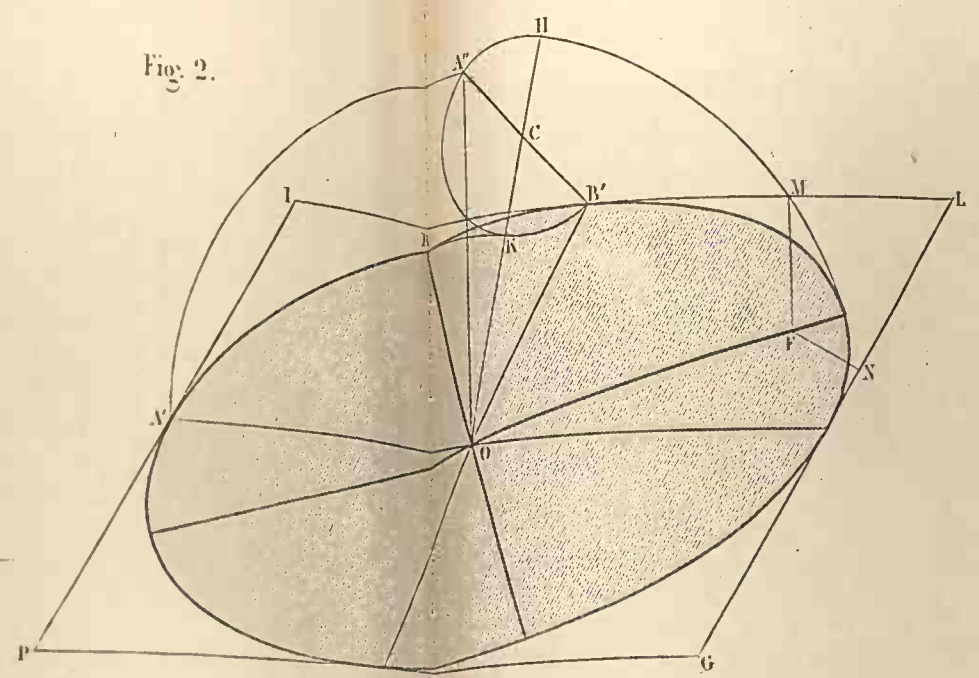

Fig. 5.

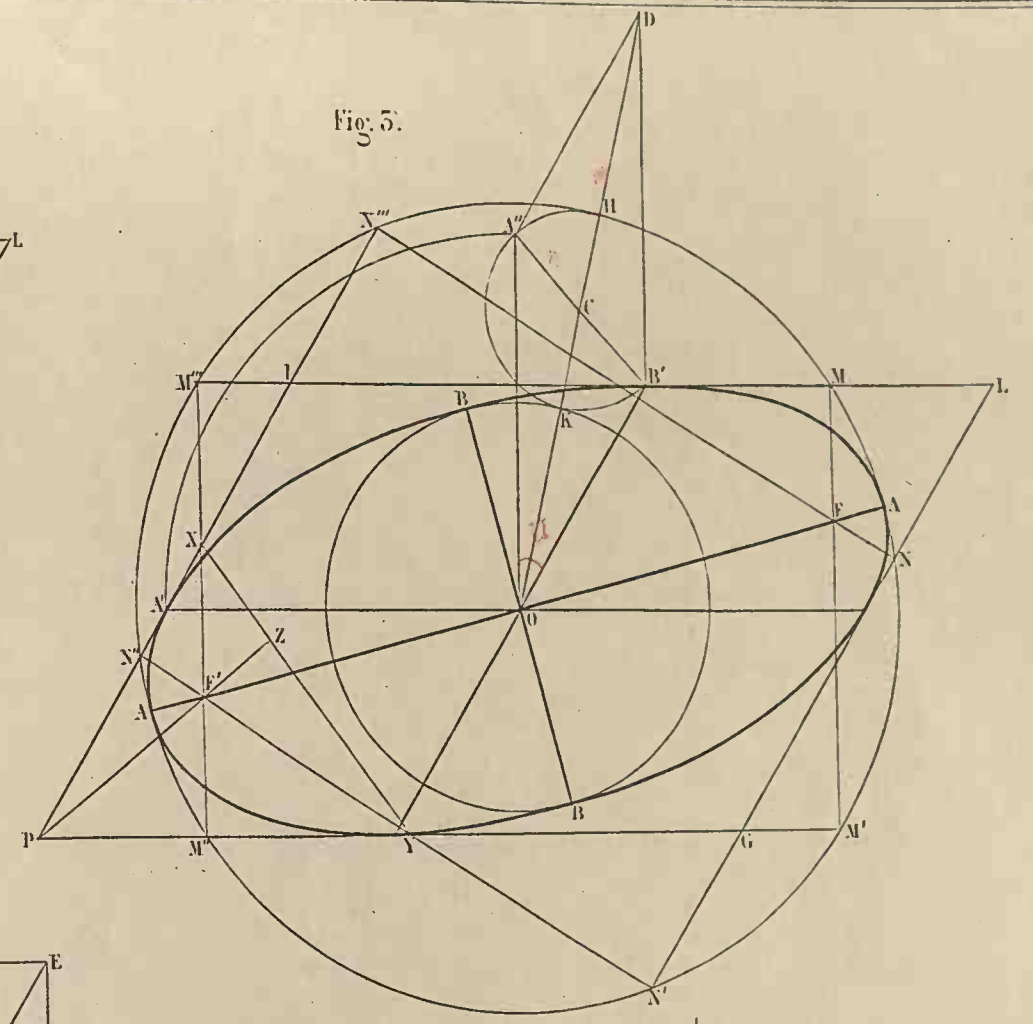

Fig. 4.

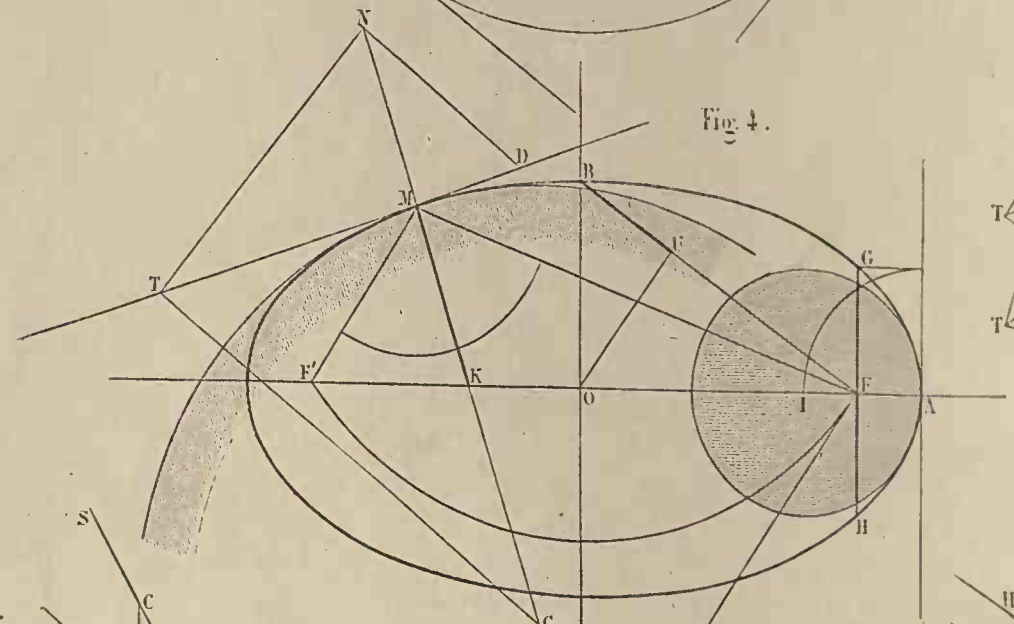

Fig. 5.

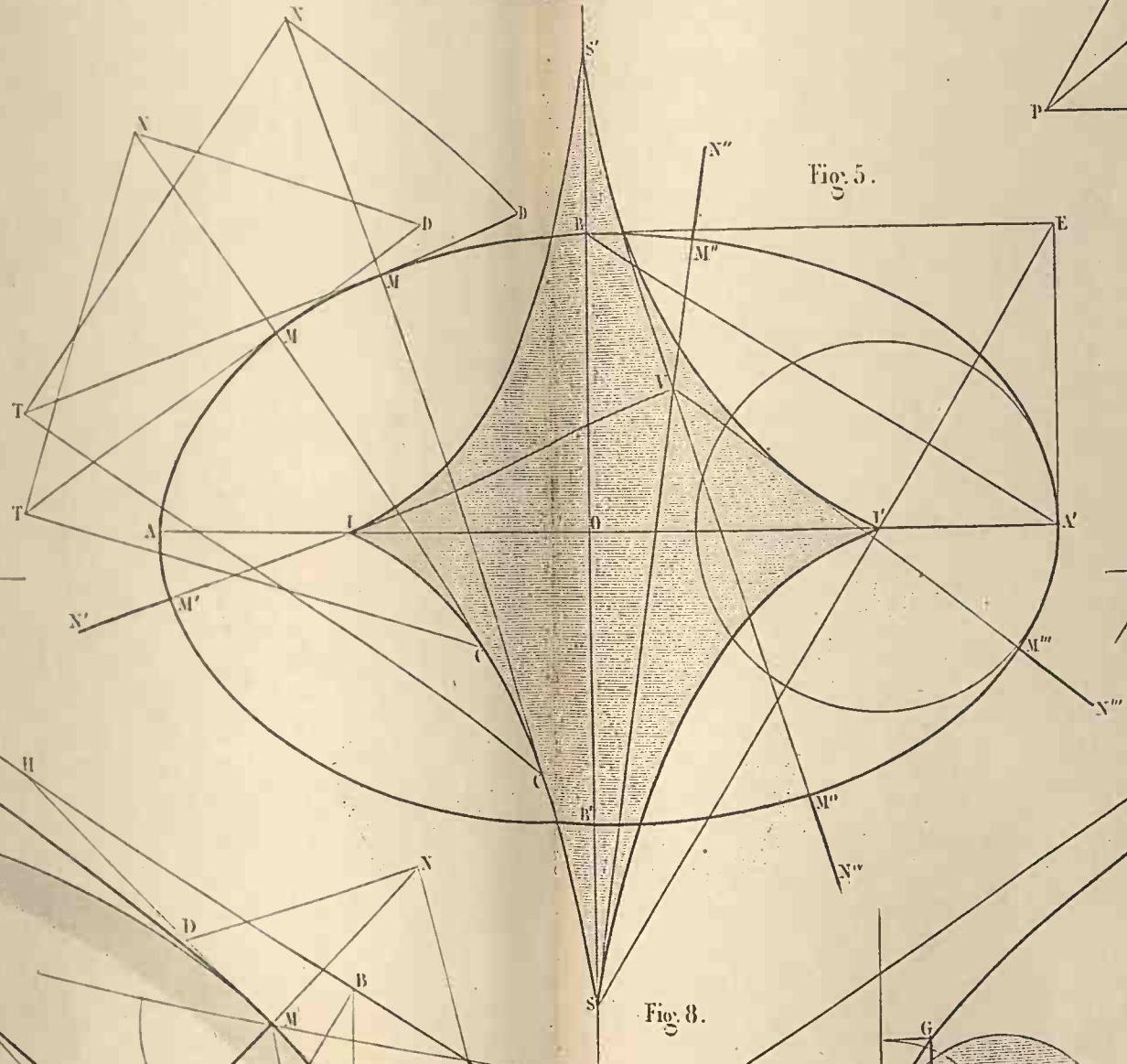

Fig. 6.

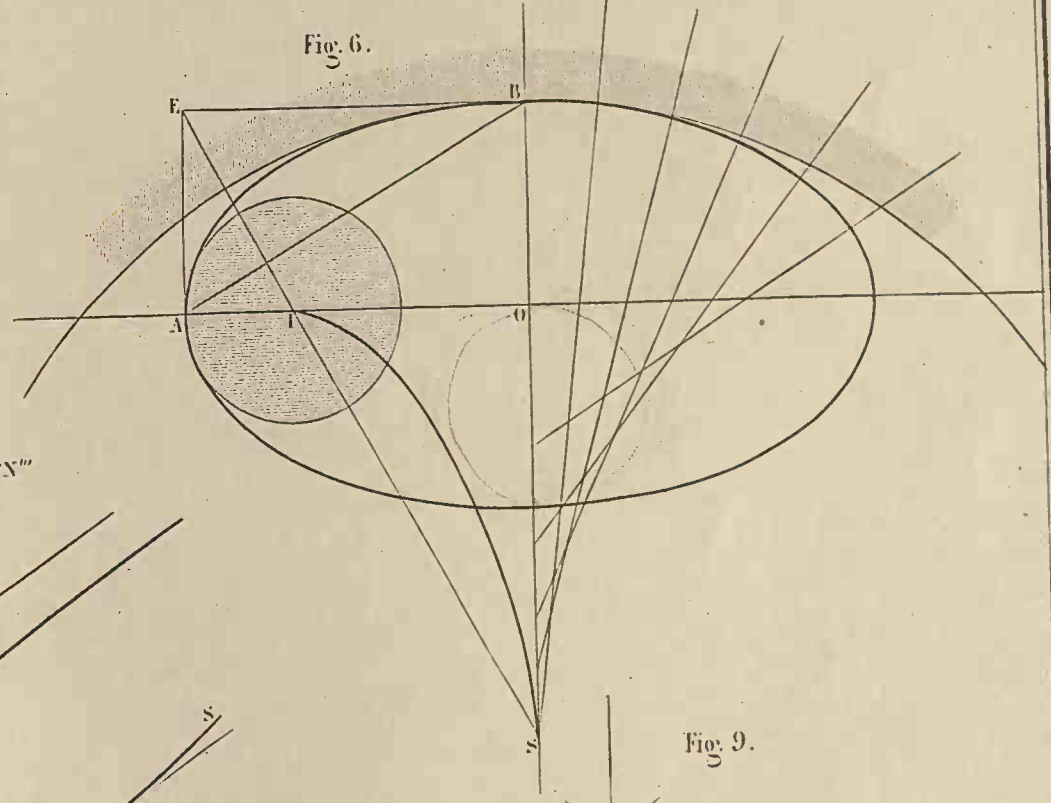

Fig. 7.

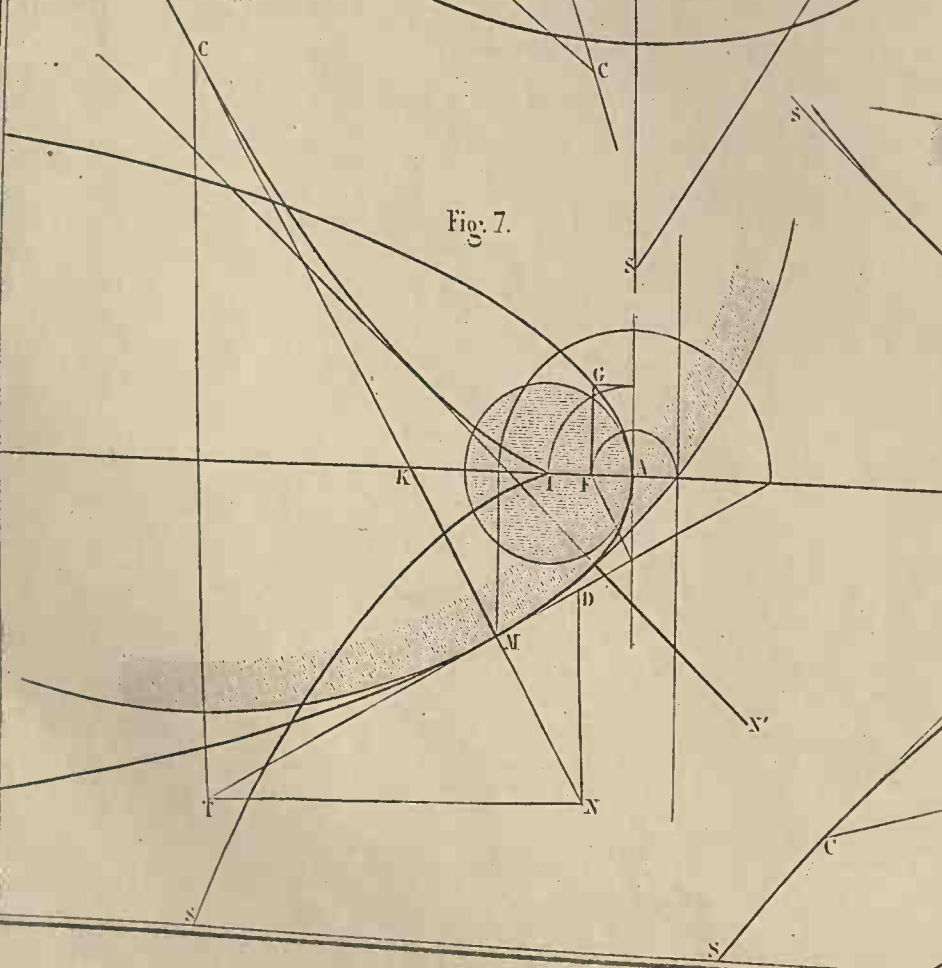

Fig. 8.

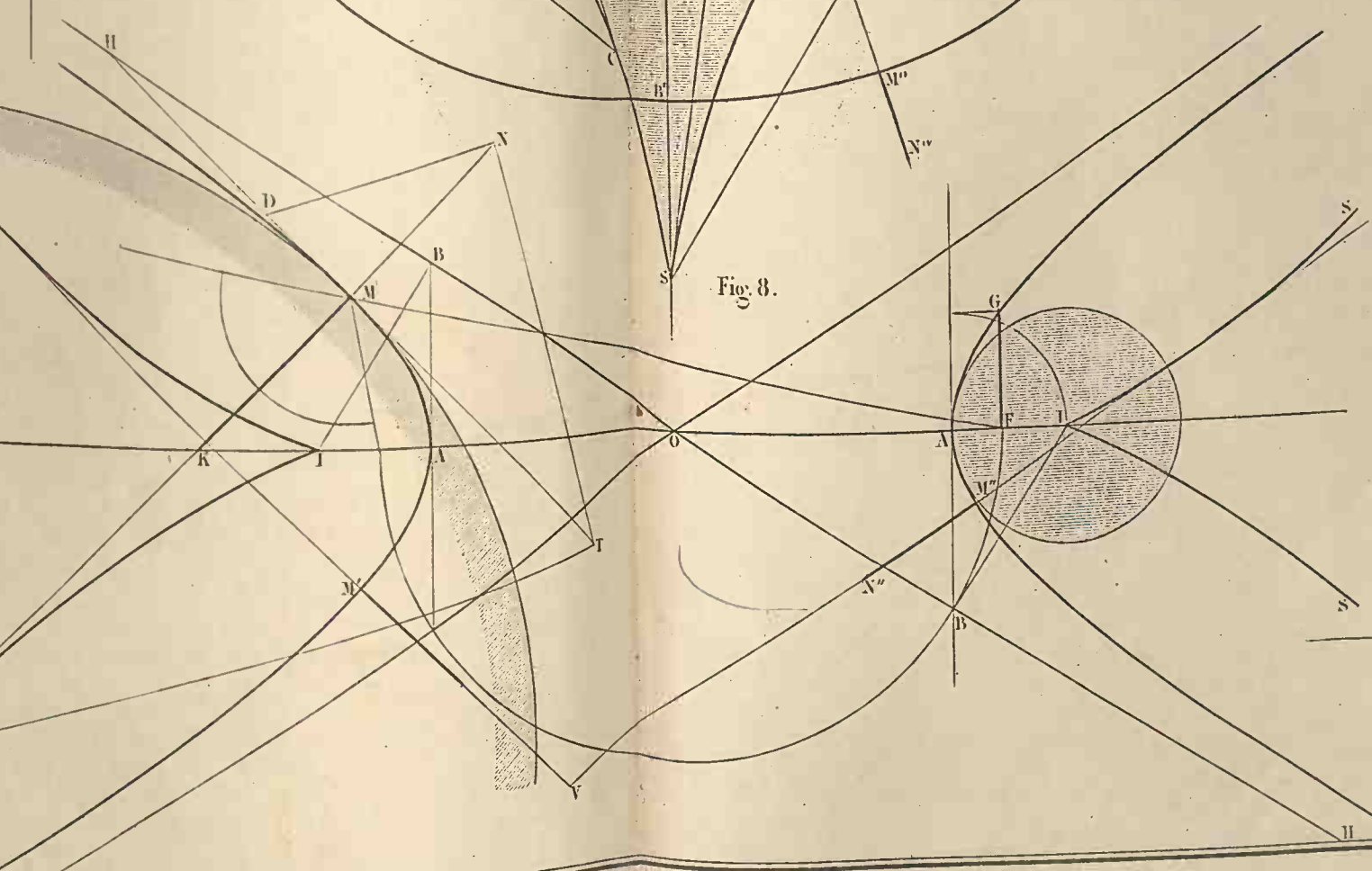
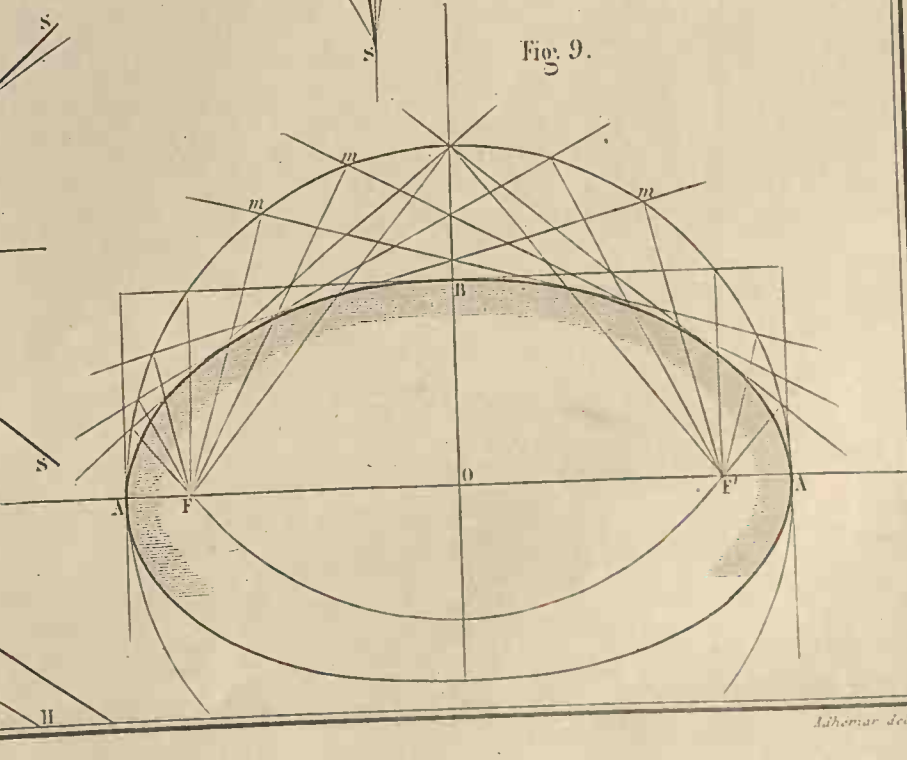
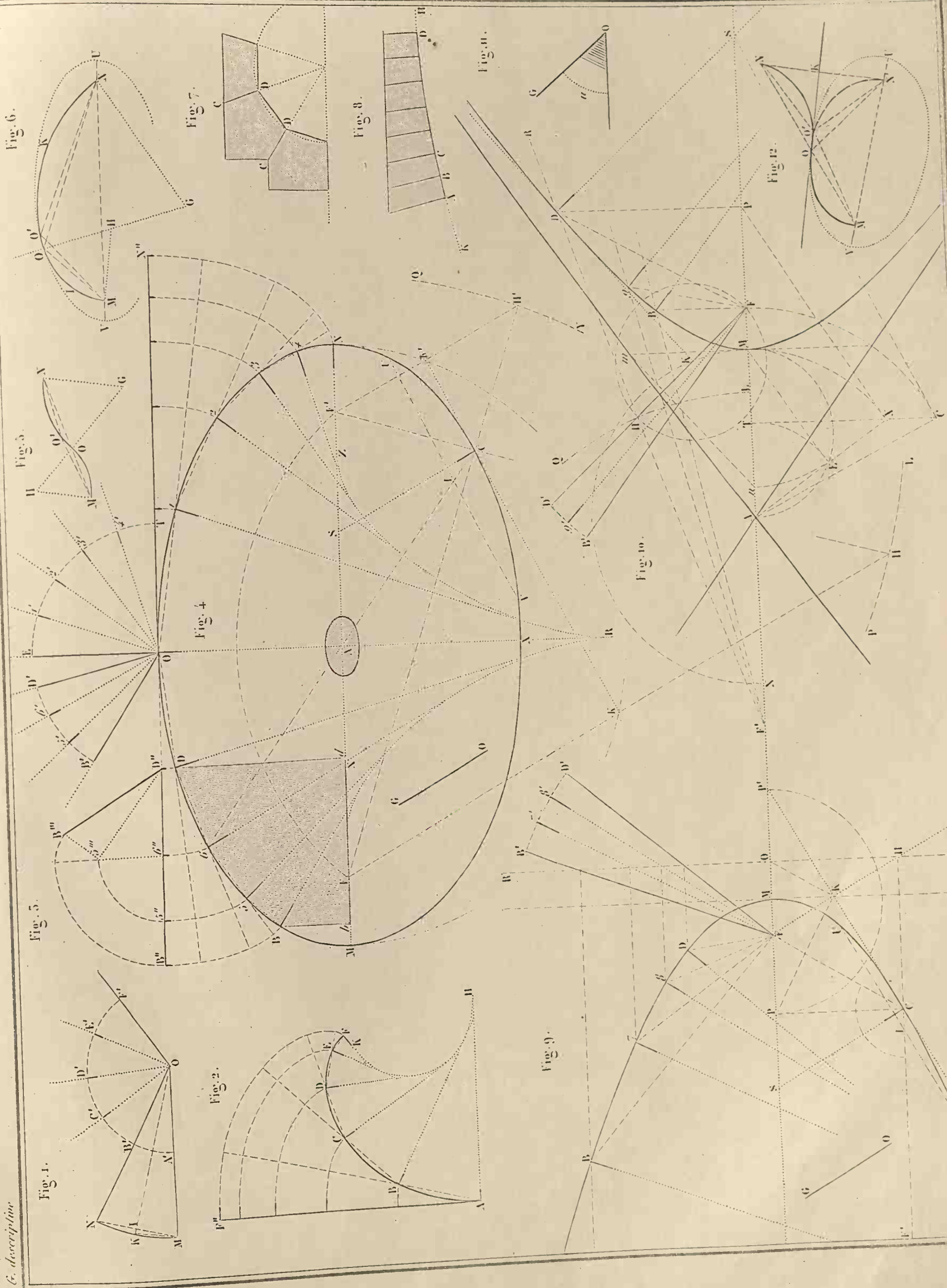

Fig. 9.



RECTIFICATION ET QUADRATURE DES COURBES

G. descriptive



224

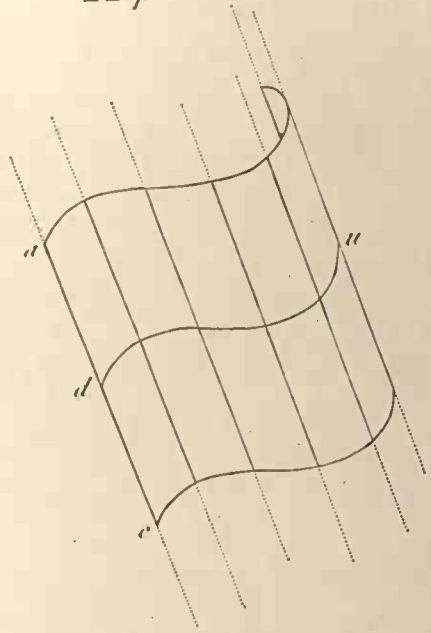

225

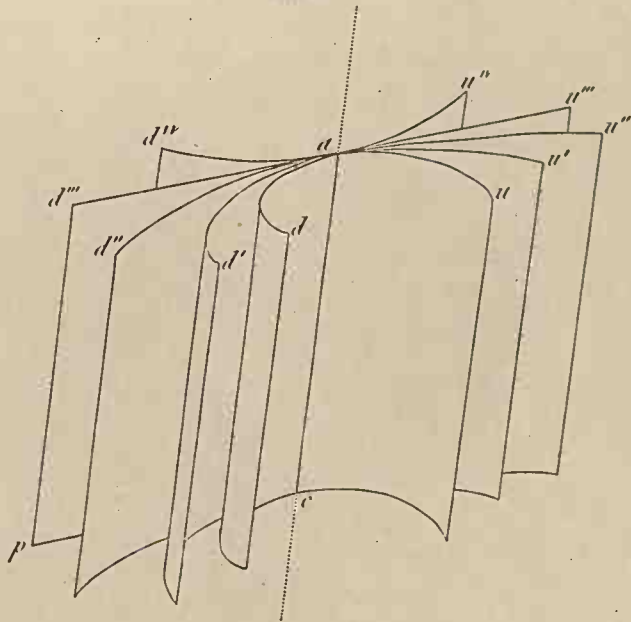

226

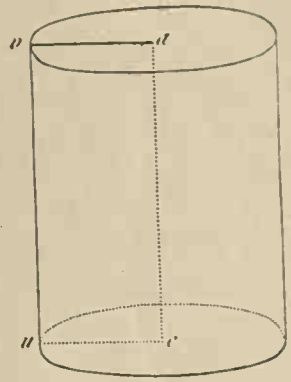

227

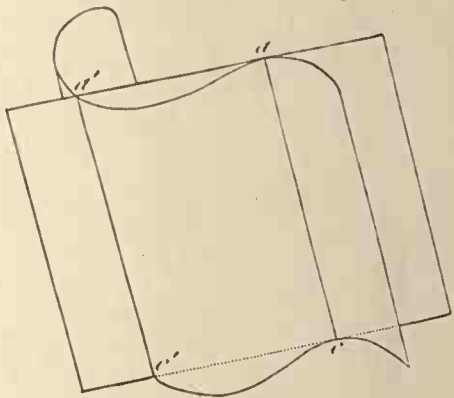

228

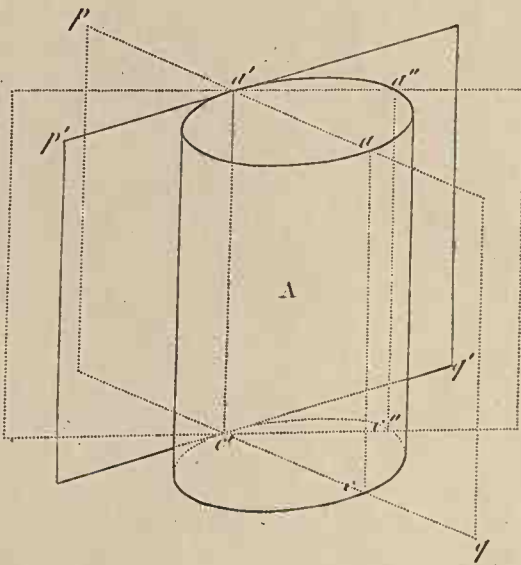

229

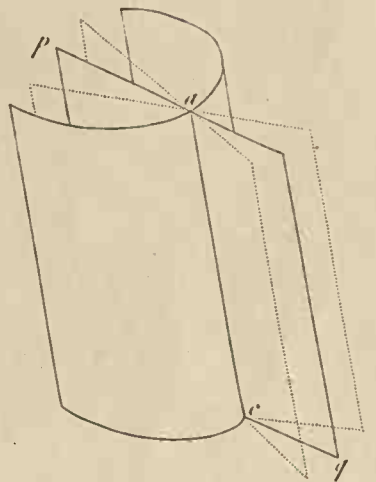

230

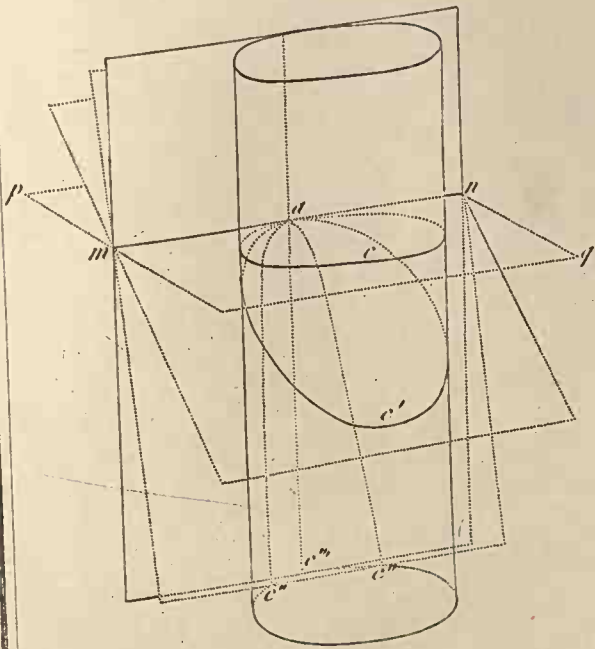

231

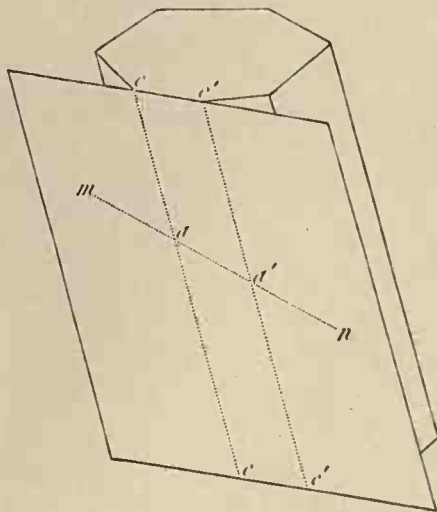

232

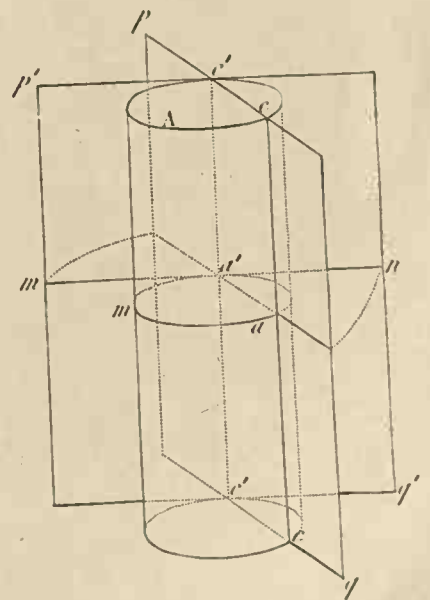

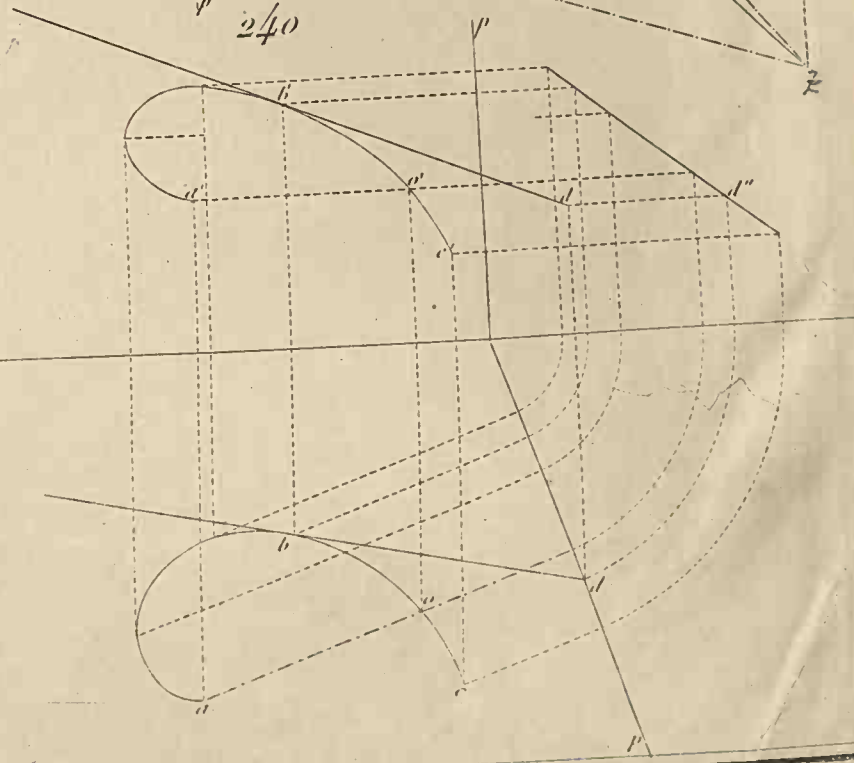
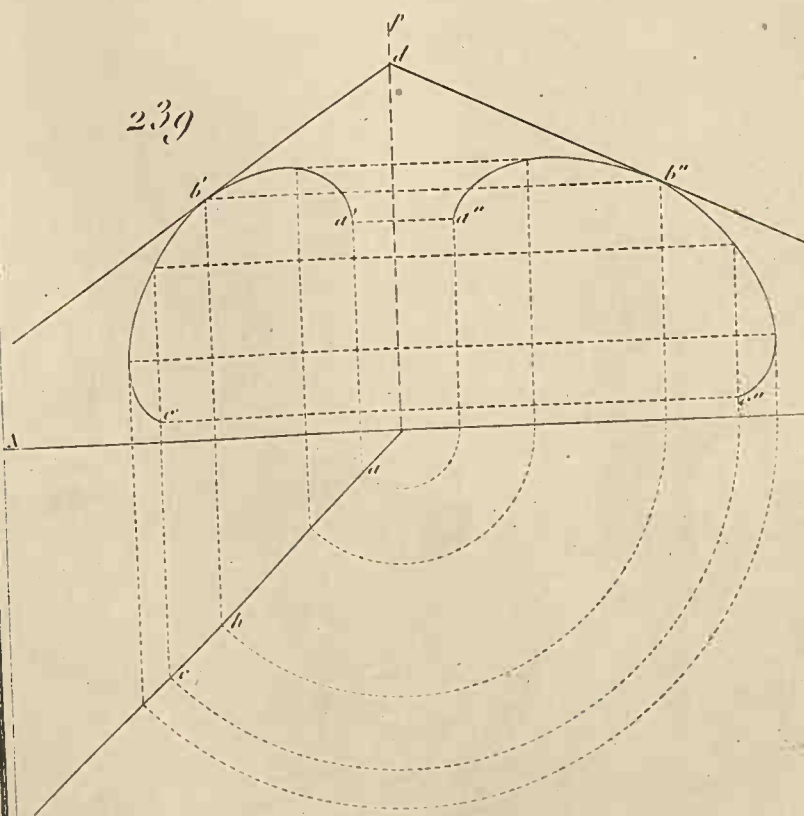
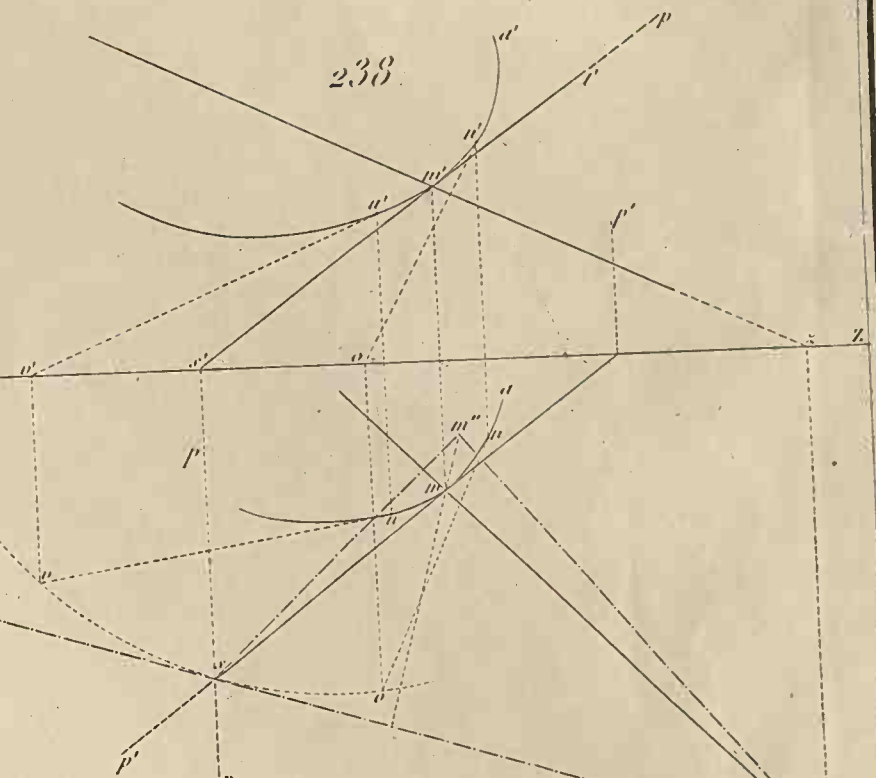
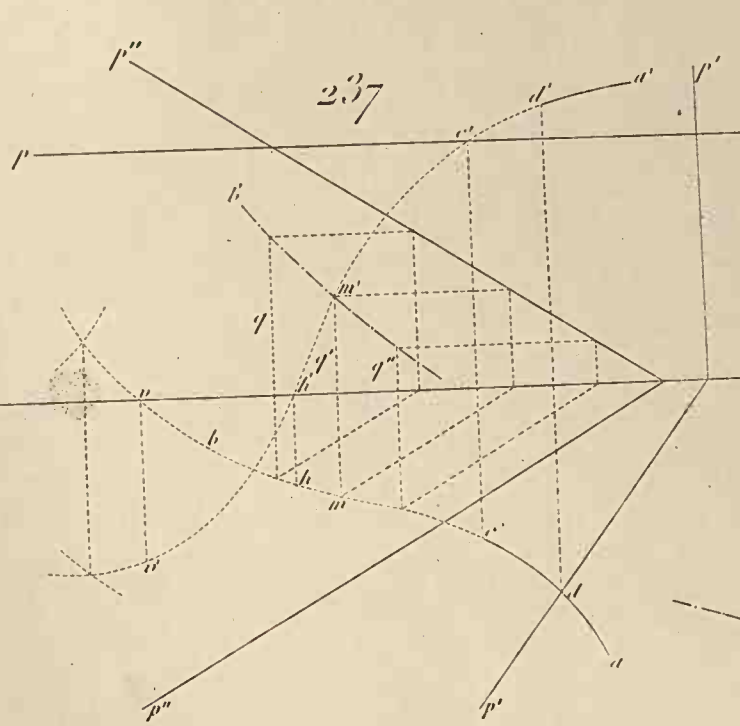
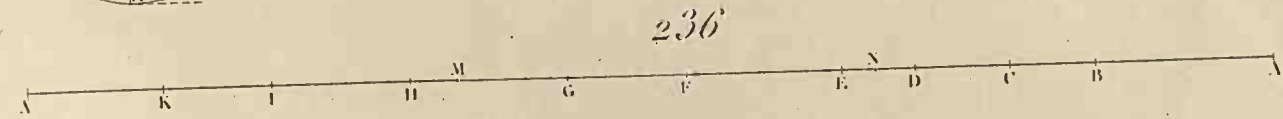
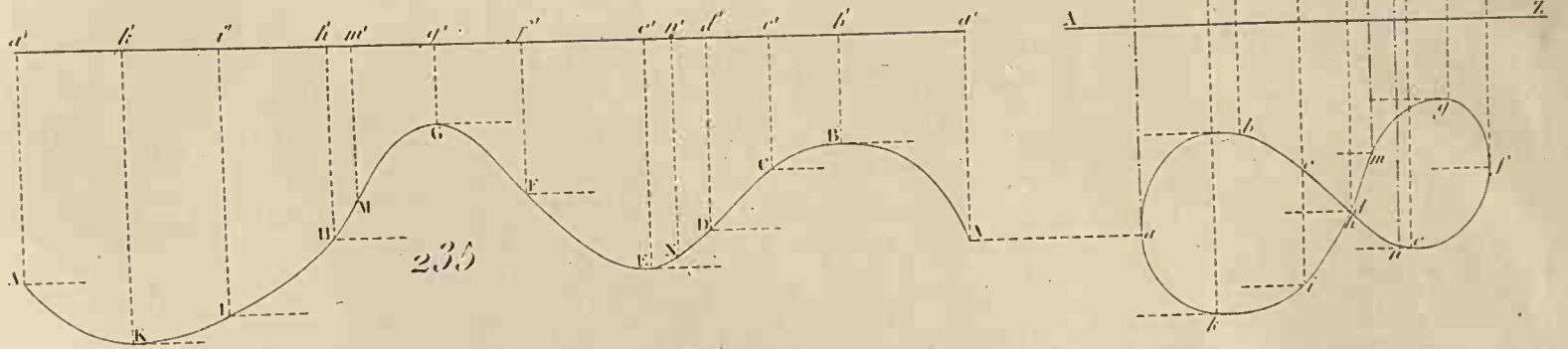
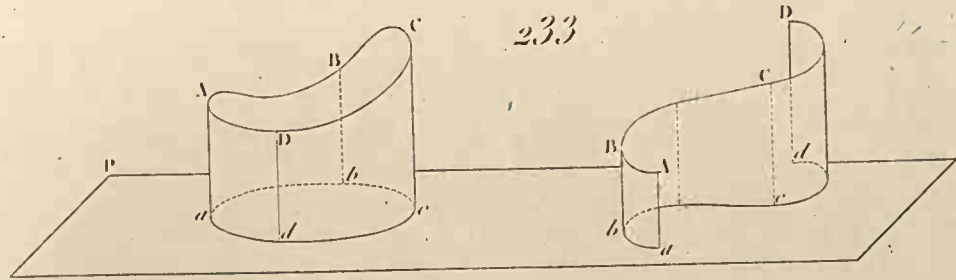

241



242

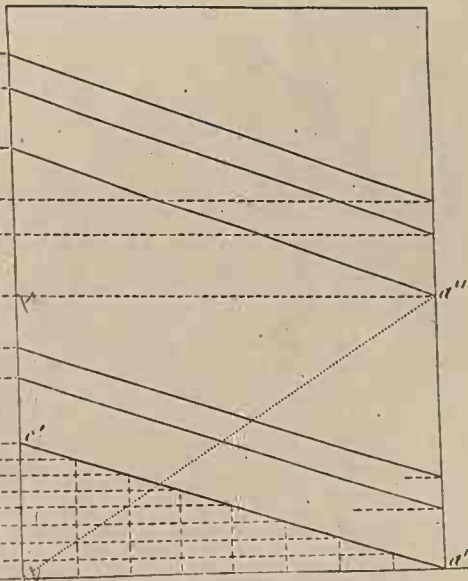

243

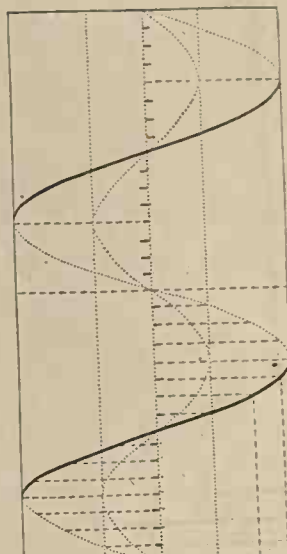

244

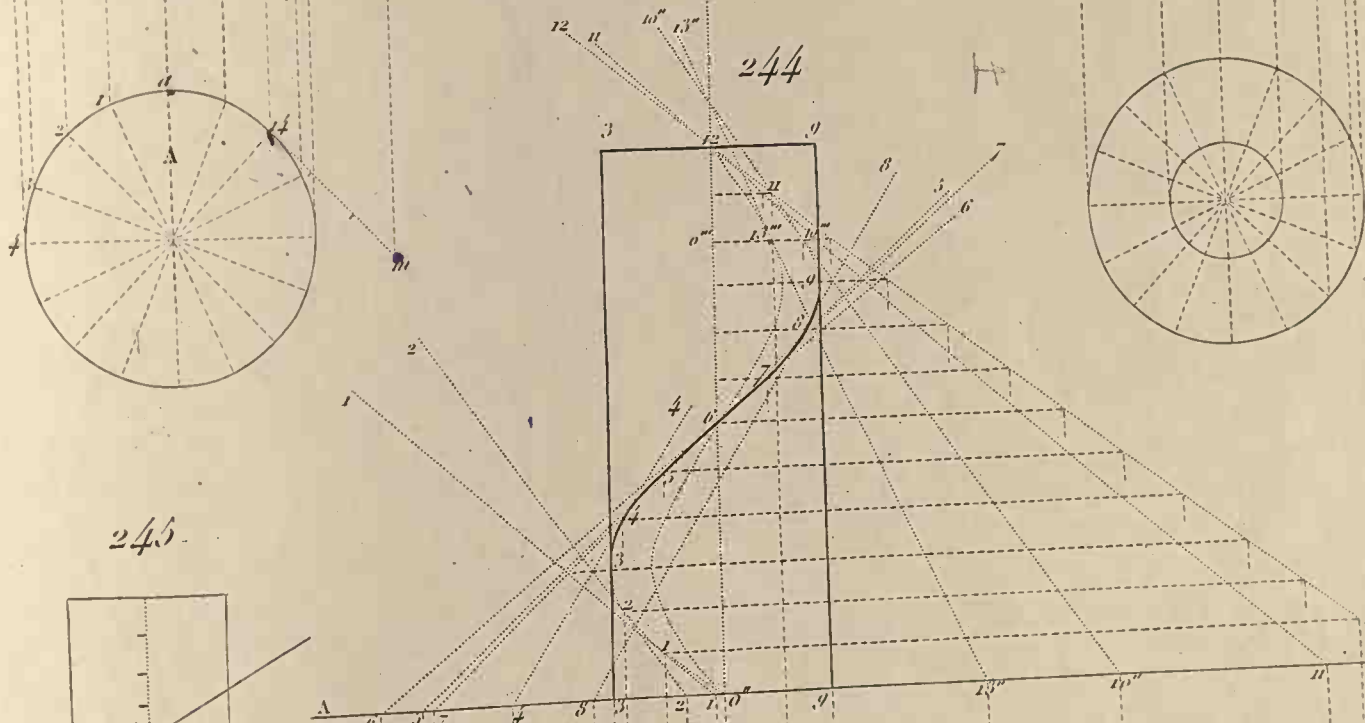

245

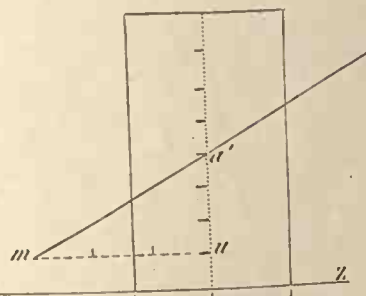

246

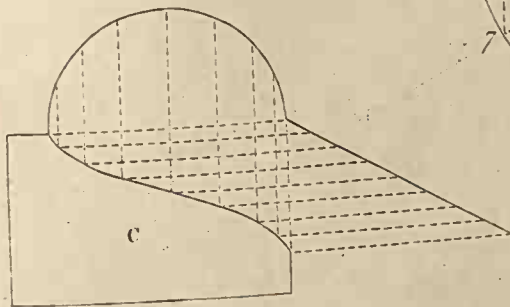

247

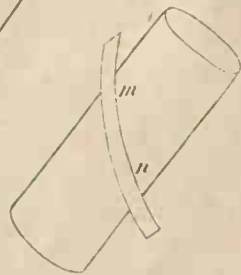

Ingenieur Raphaelia 175. Le ...

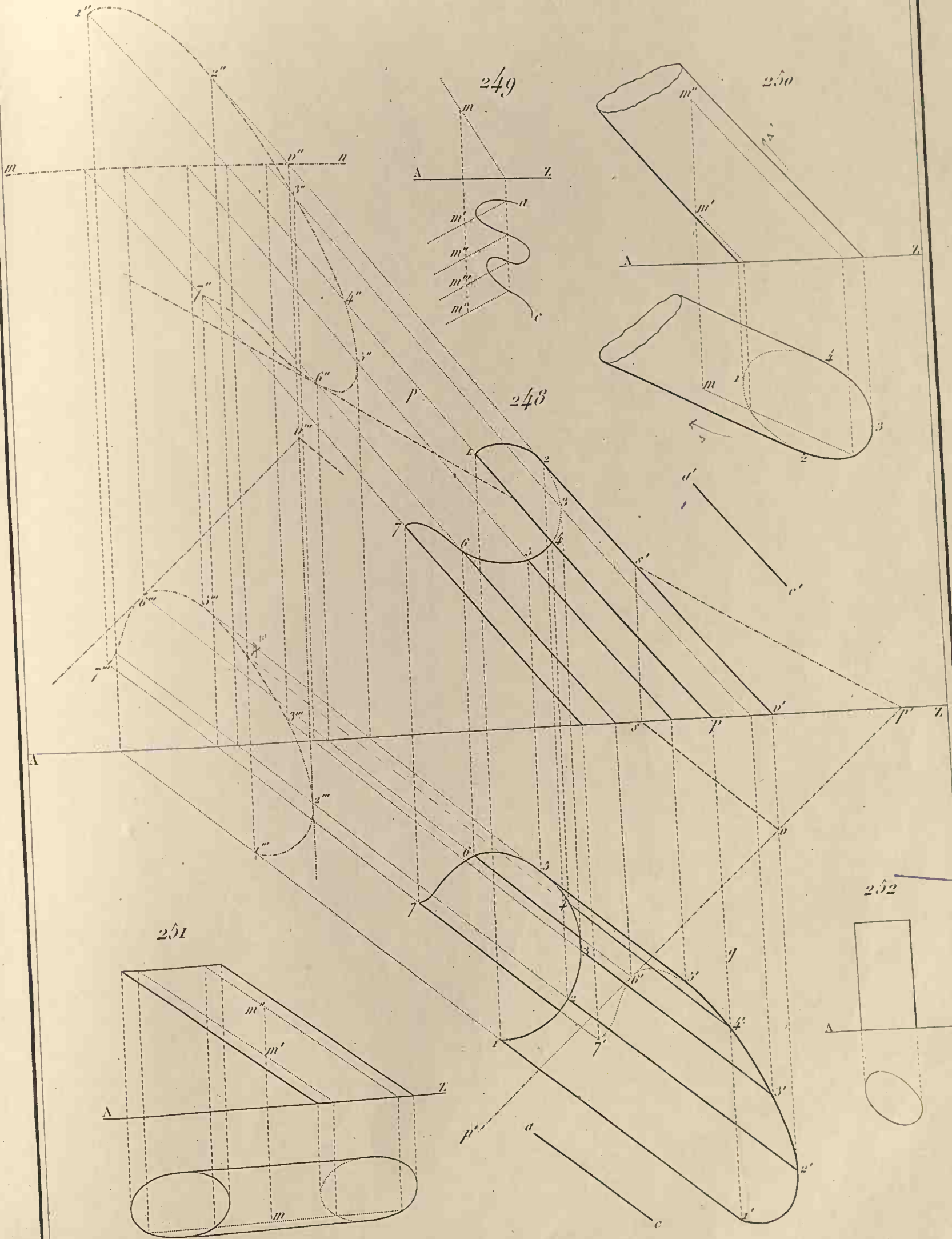

253

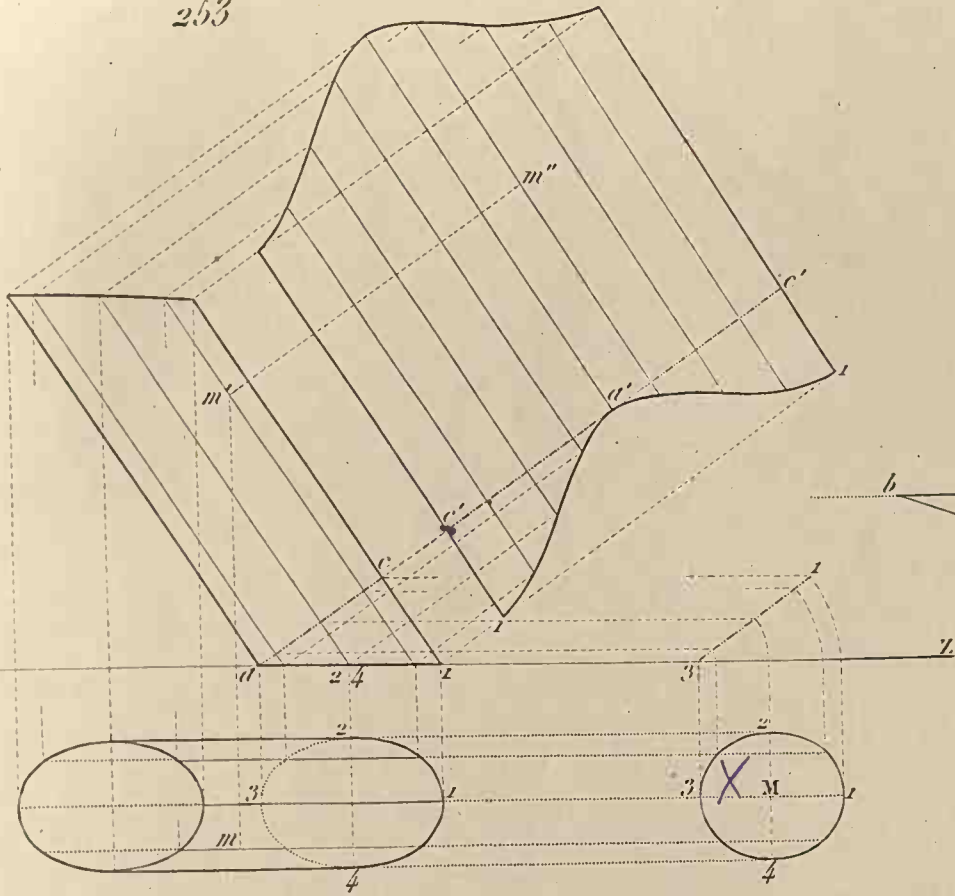

254

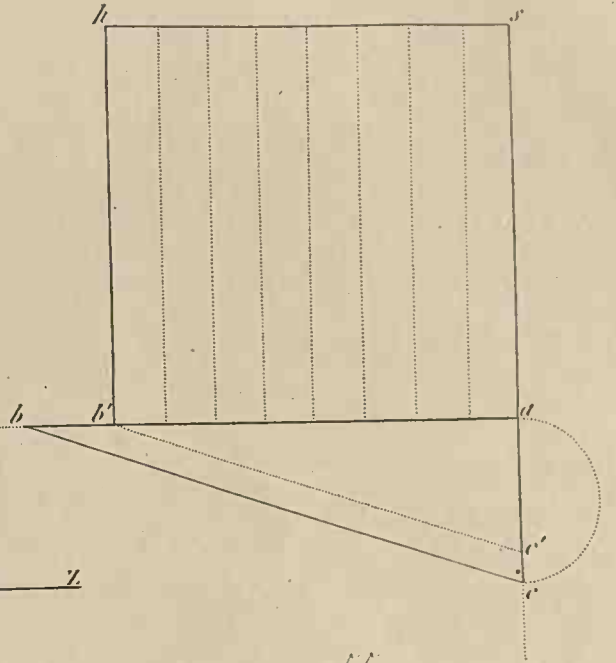

255

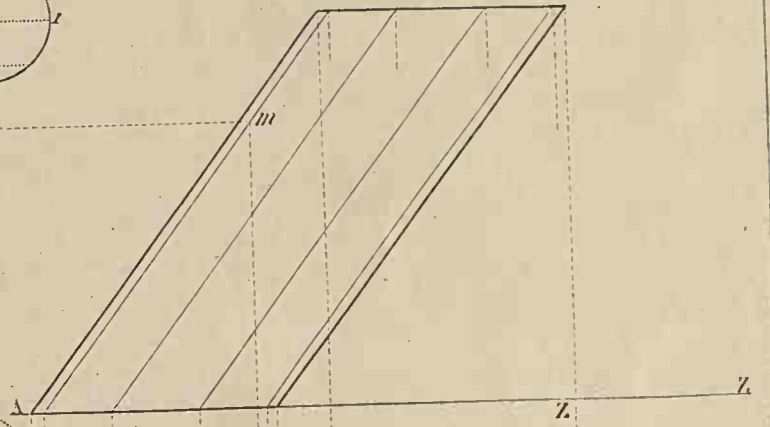

256

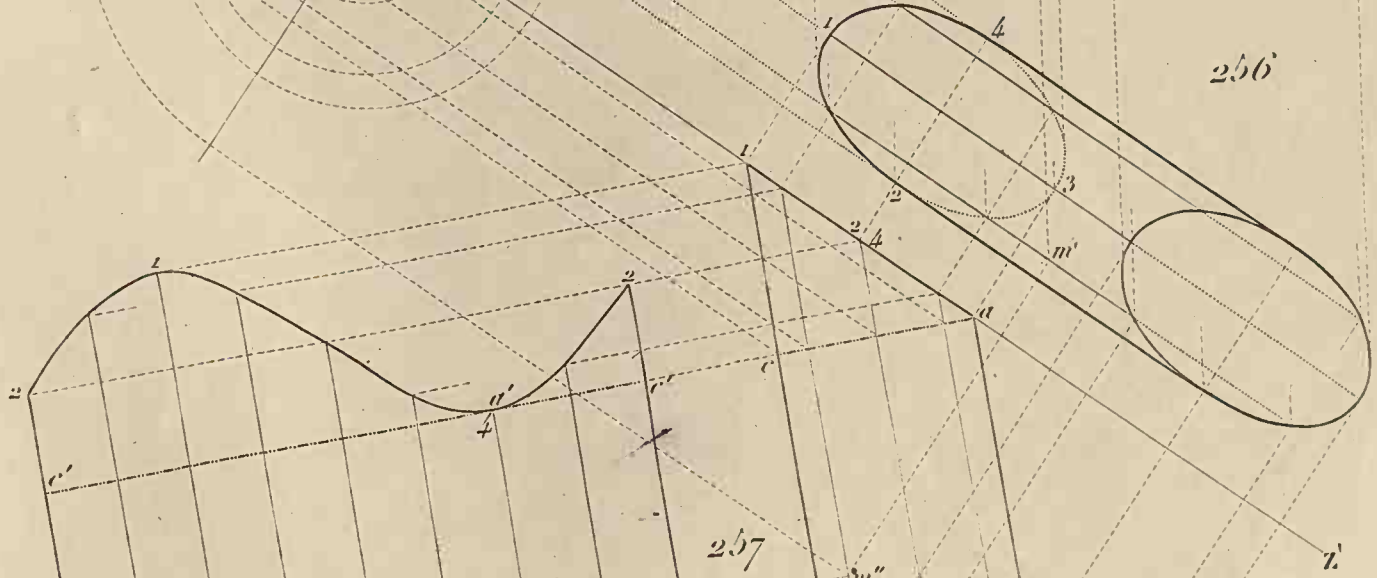

257

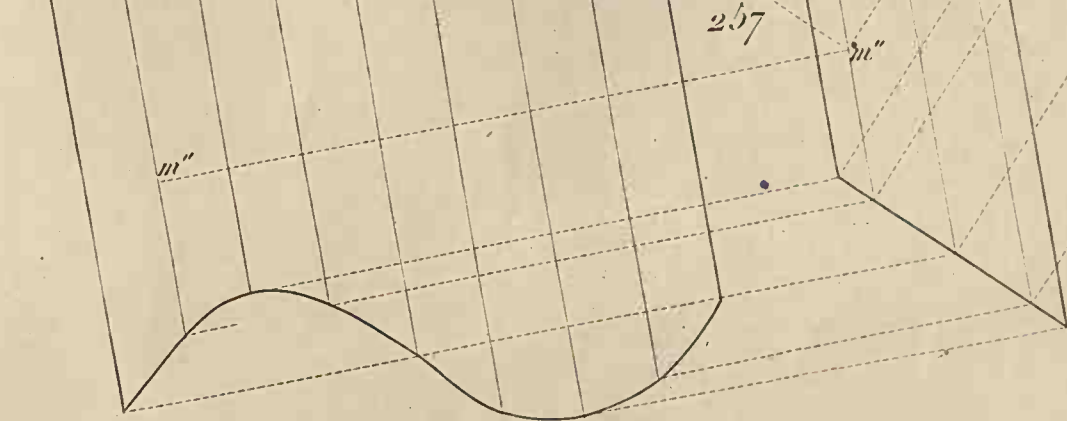

258



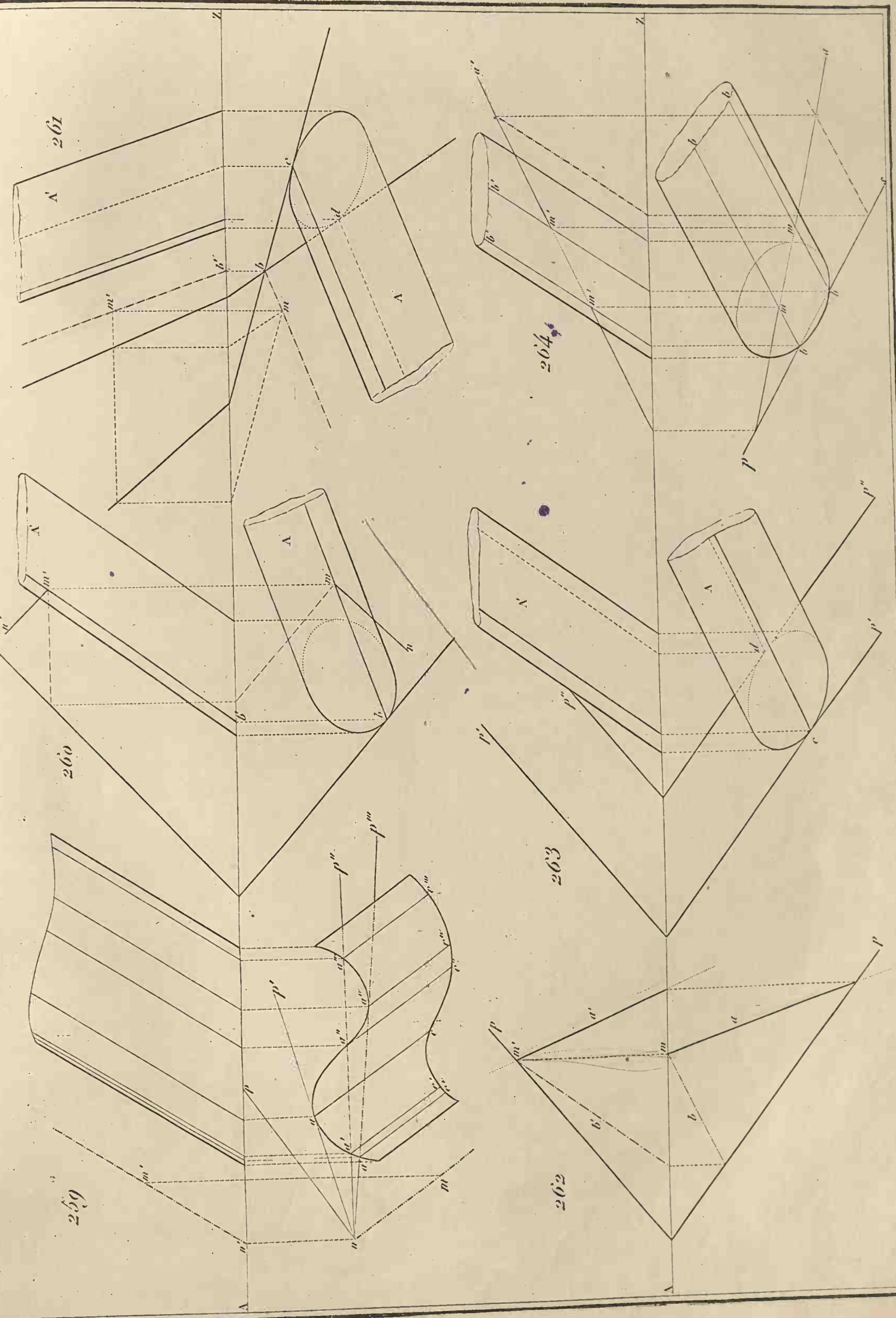

265

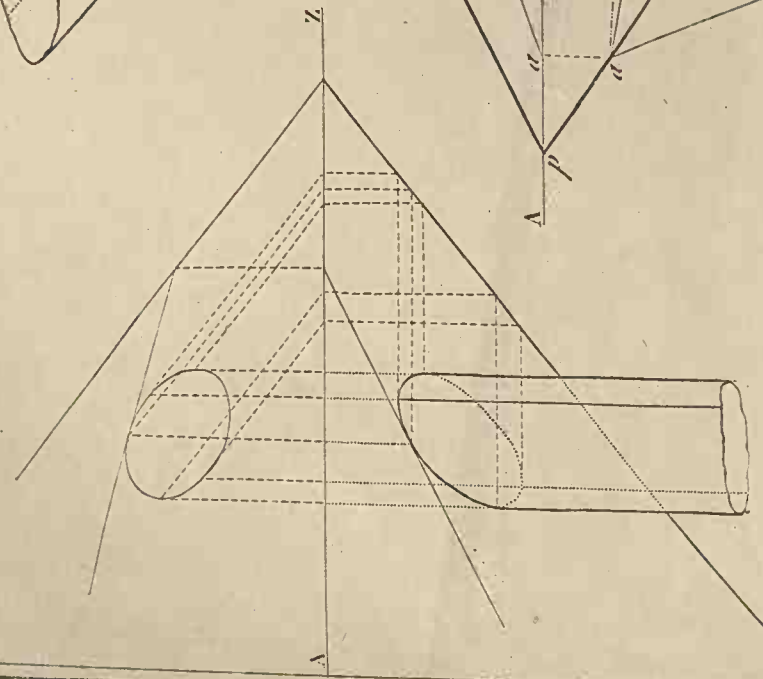

266

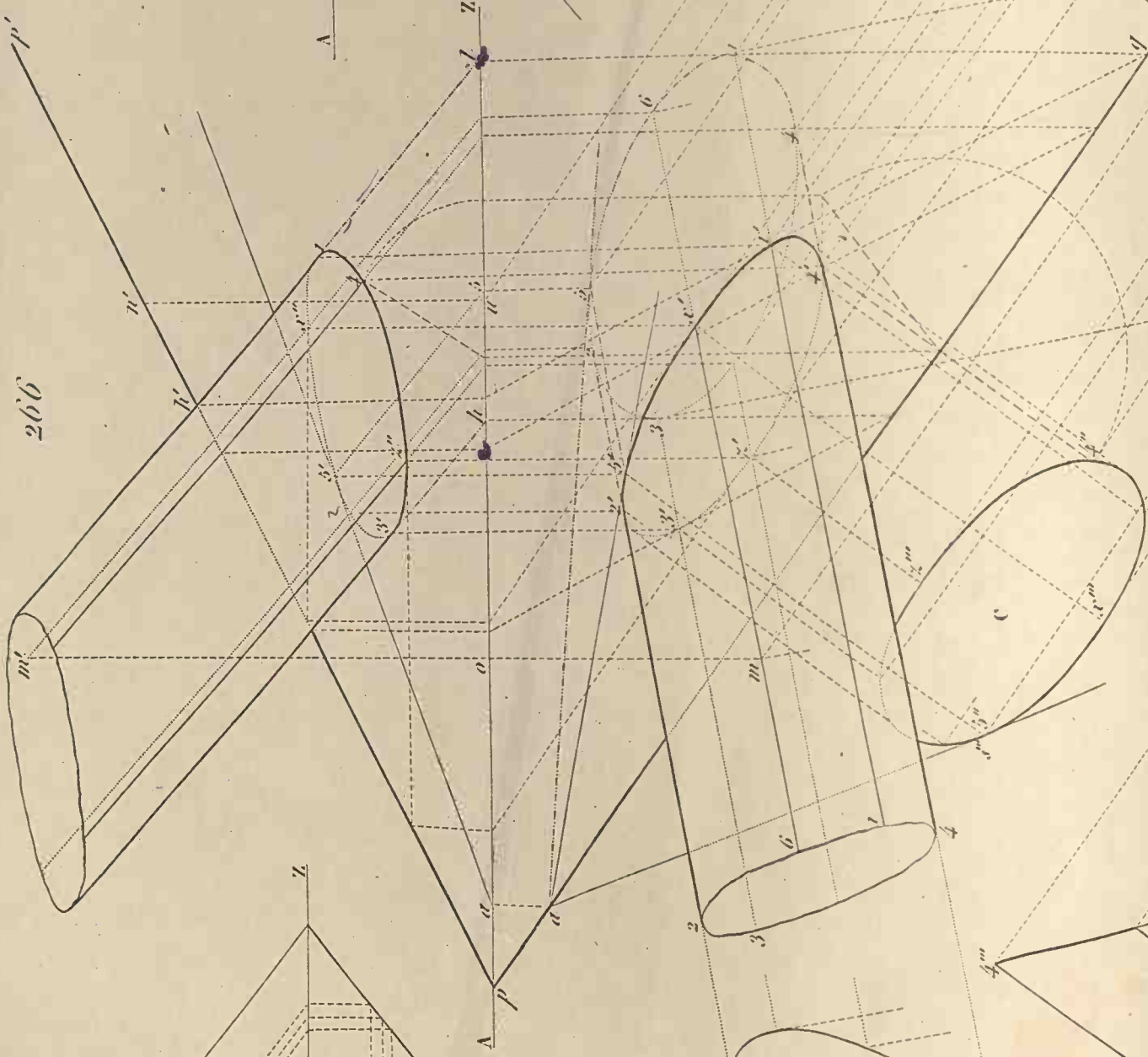

267

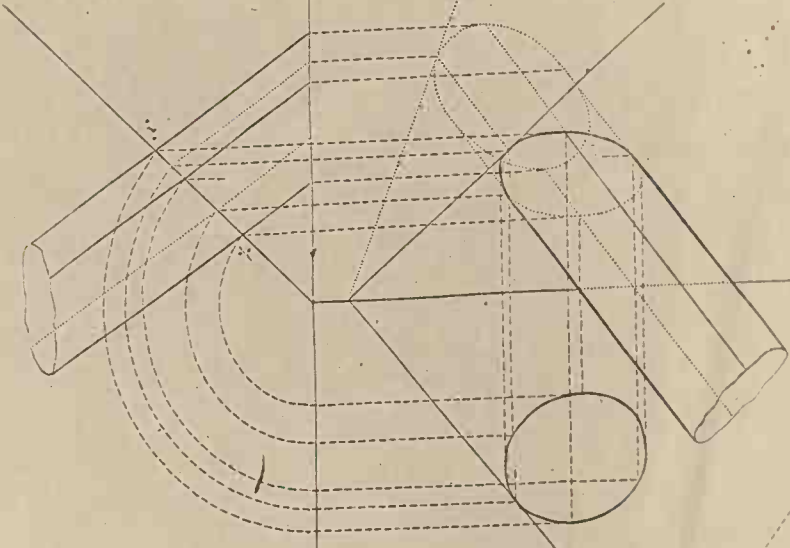

270

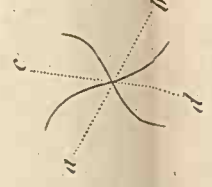

268

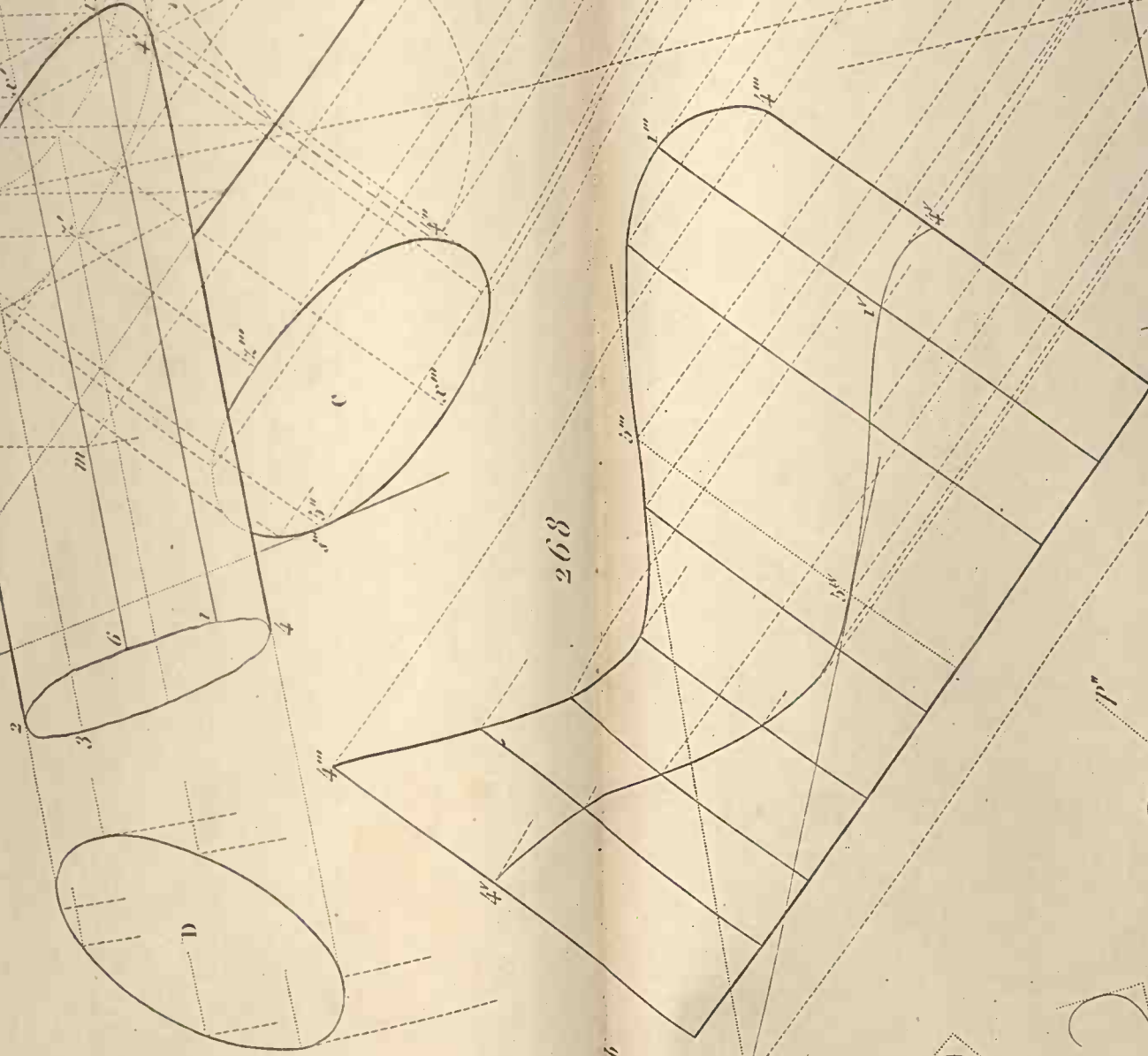

269

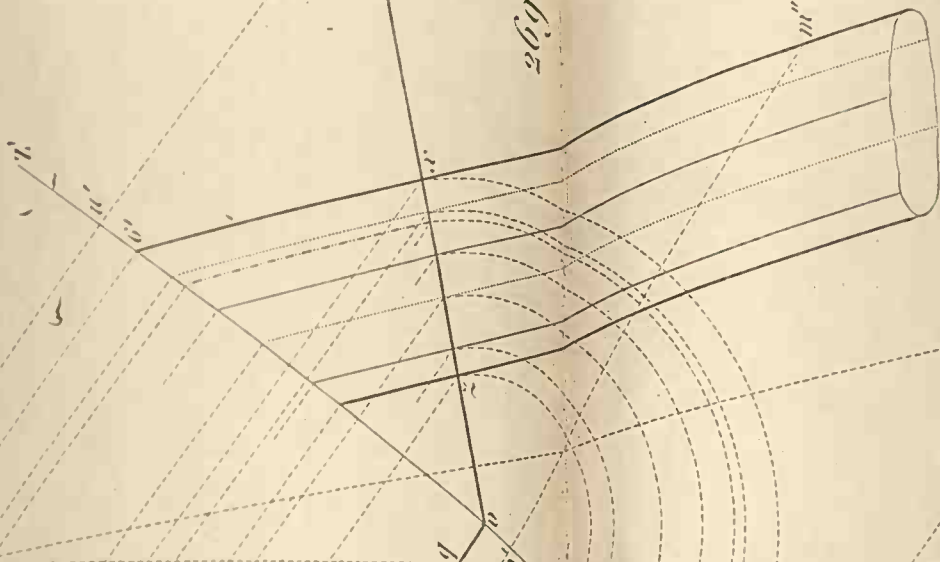

271



274

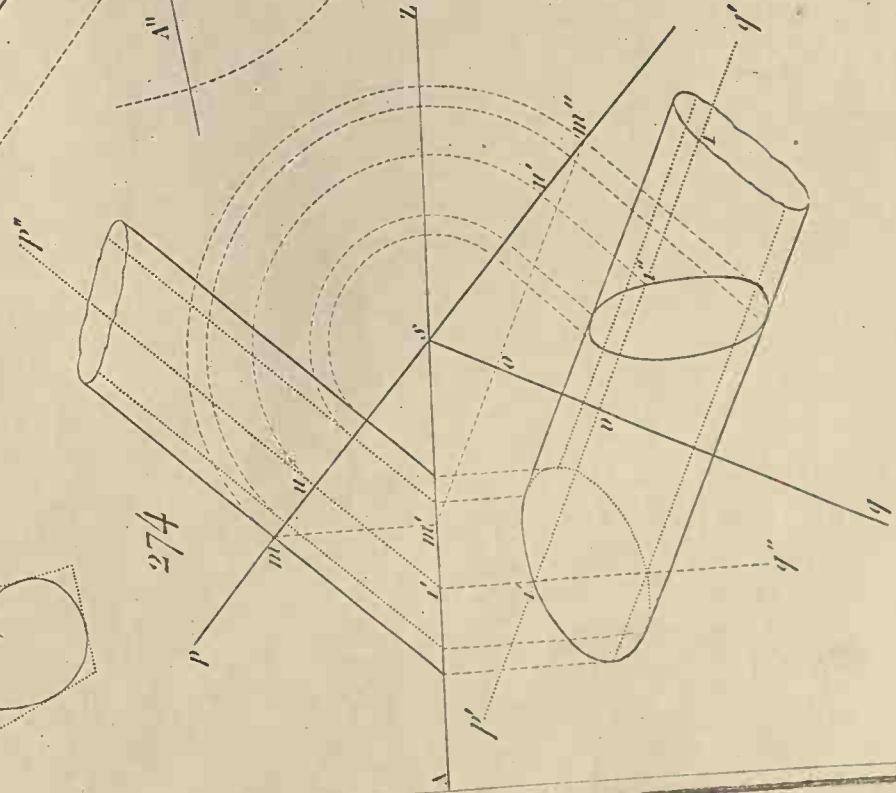

272

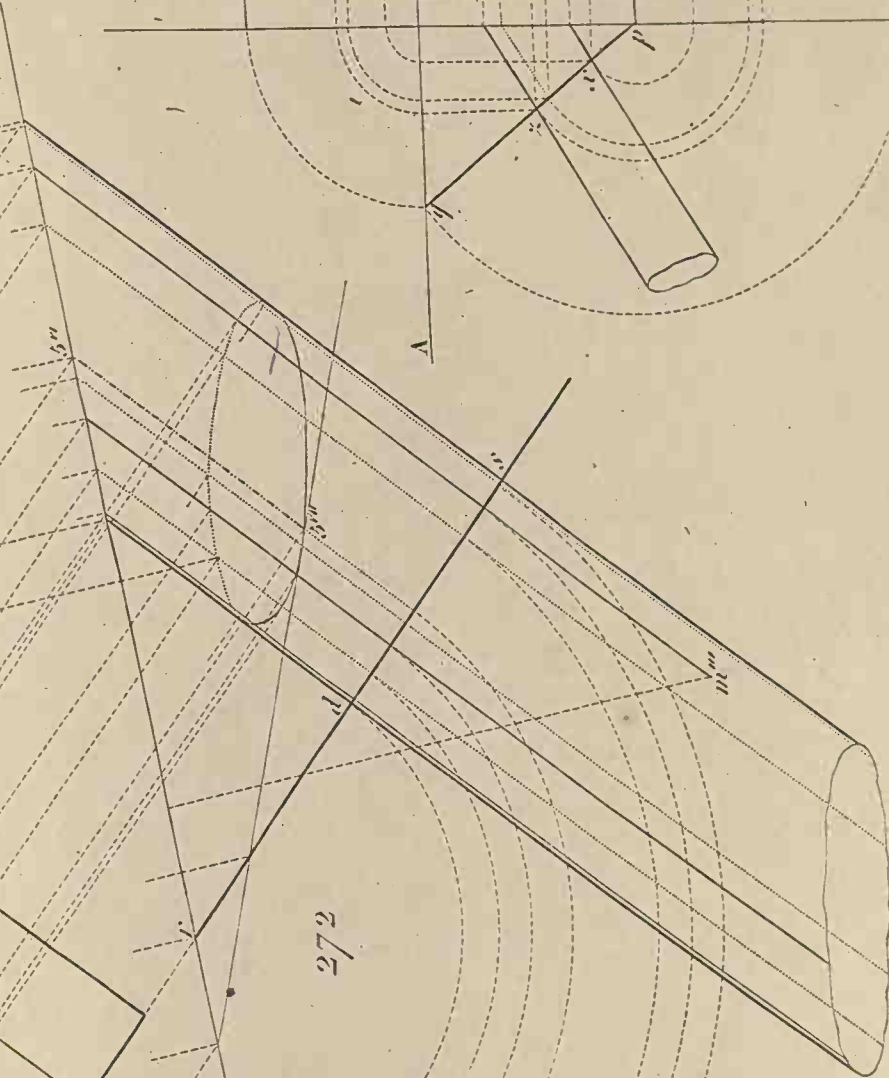

273

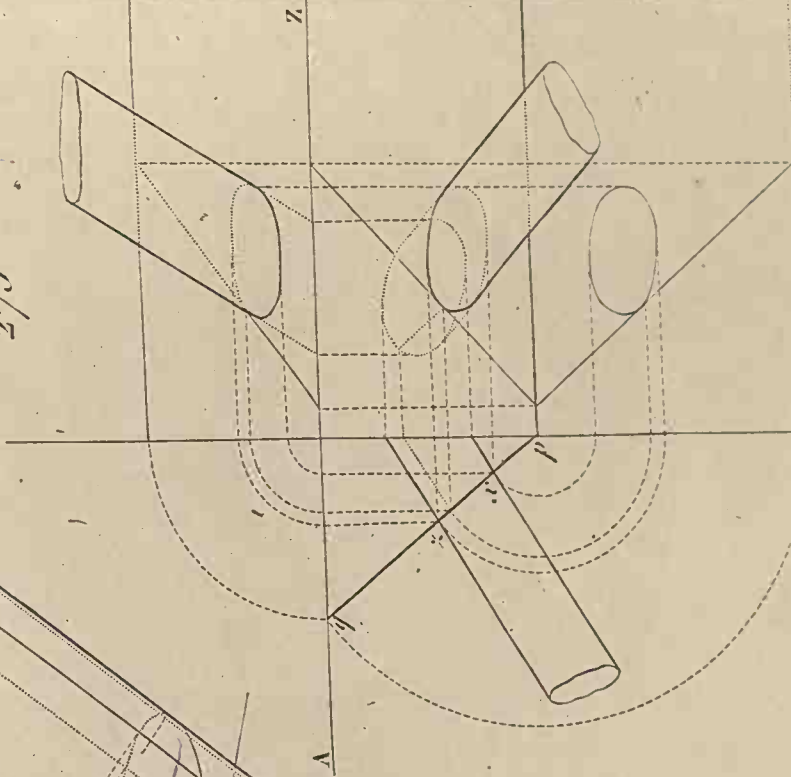

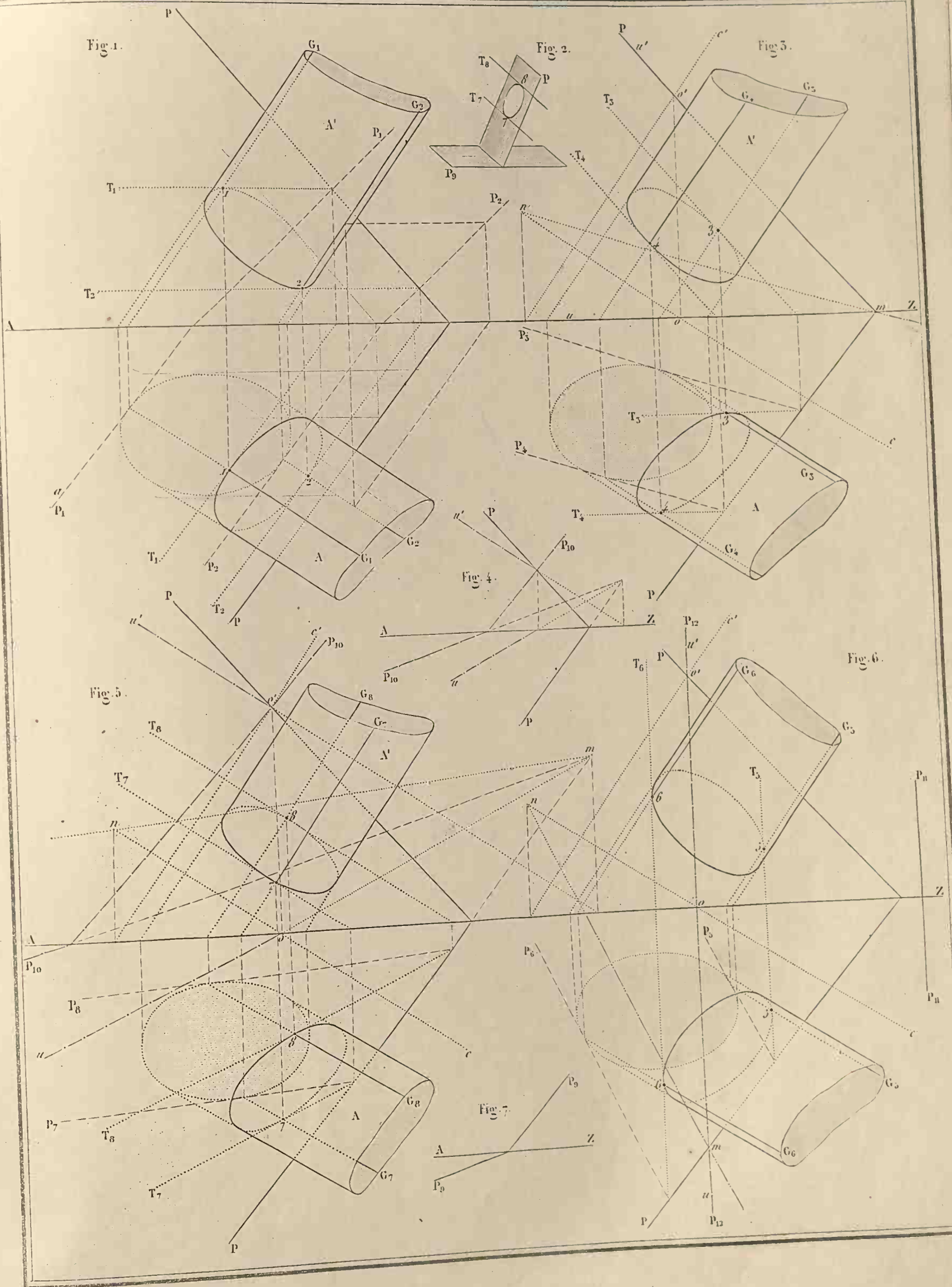

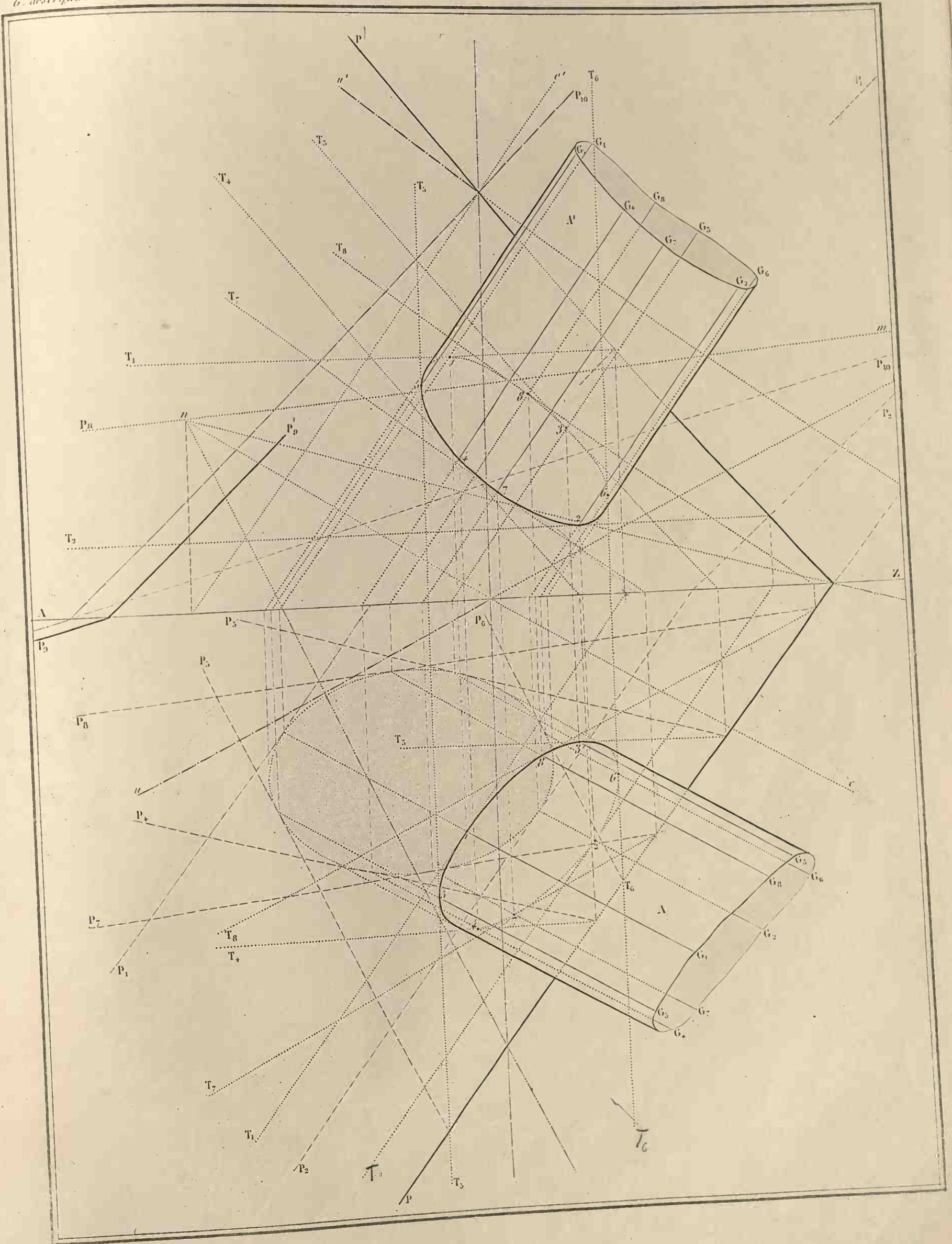

275

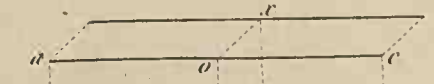
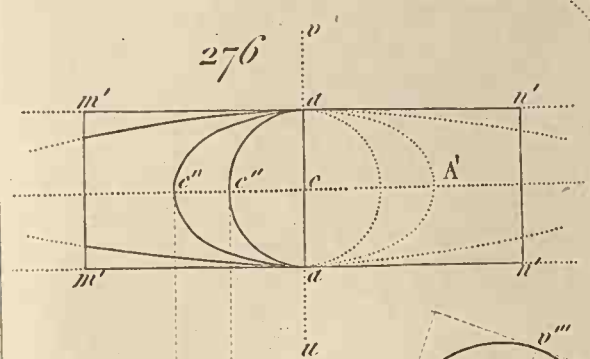
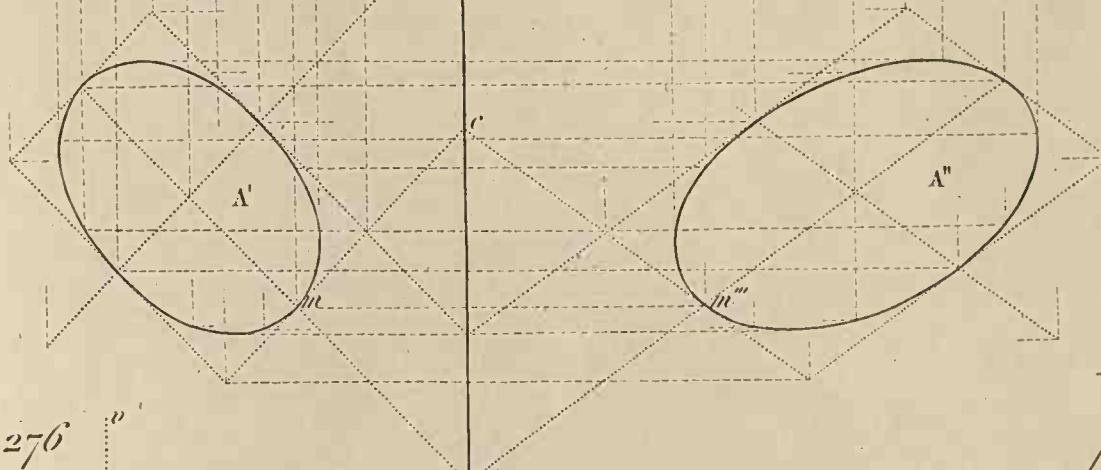
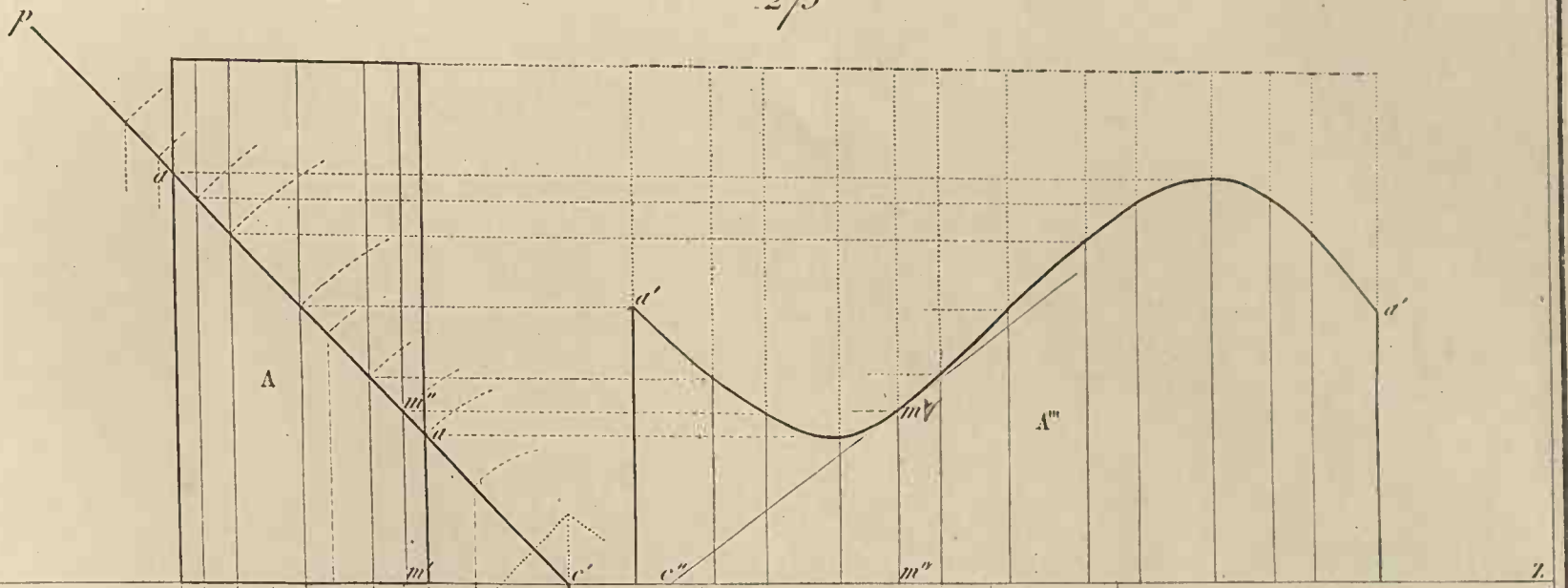

277

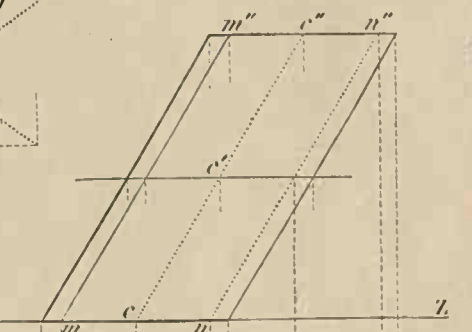
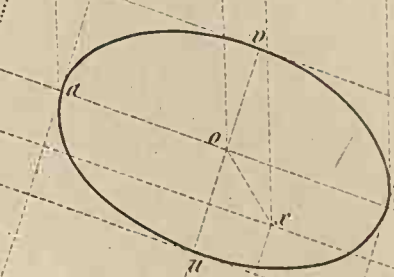
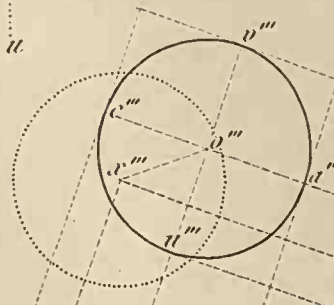

278

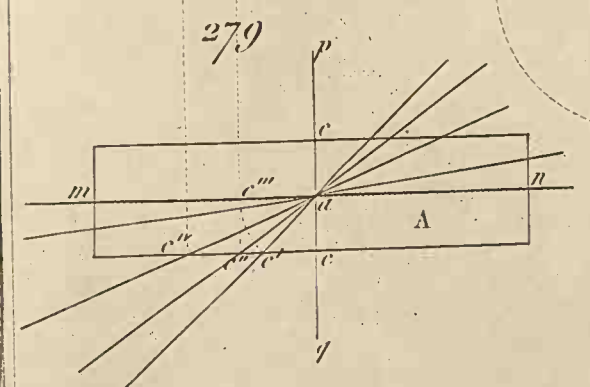
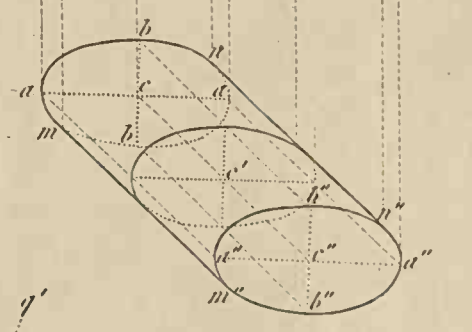

279

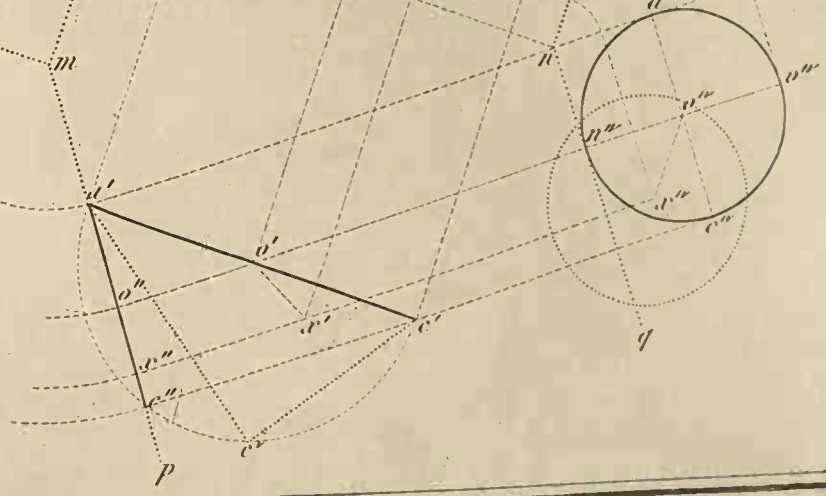

280



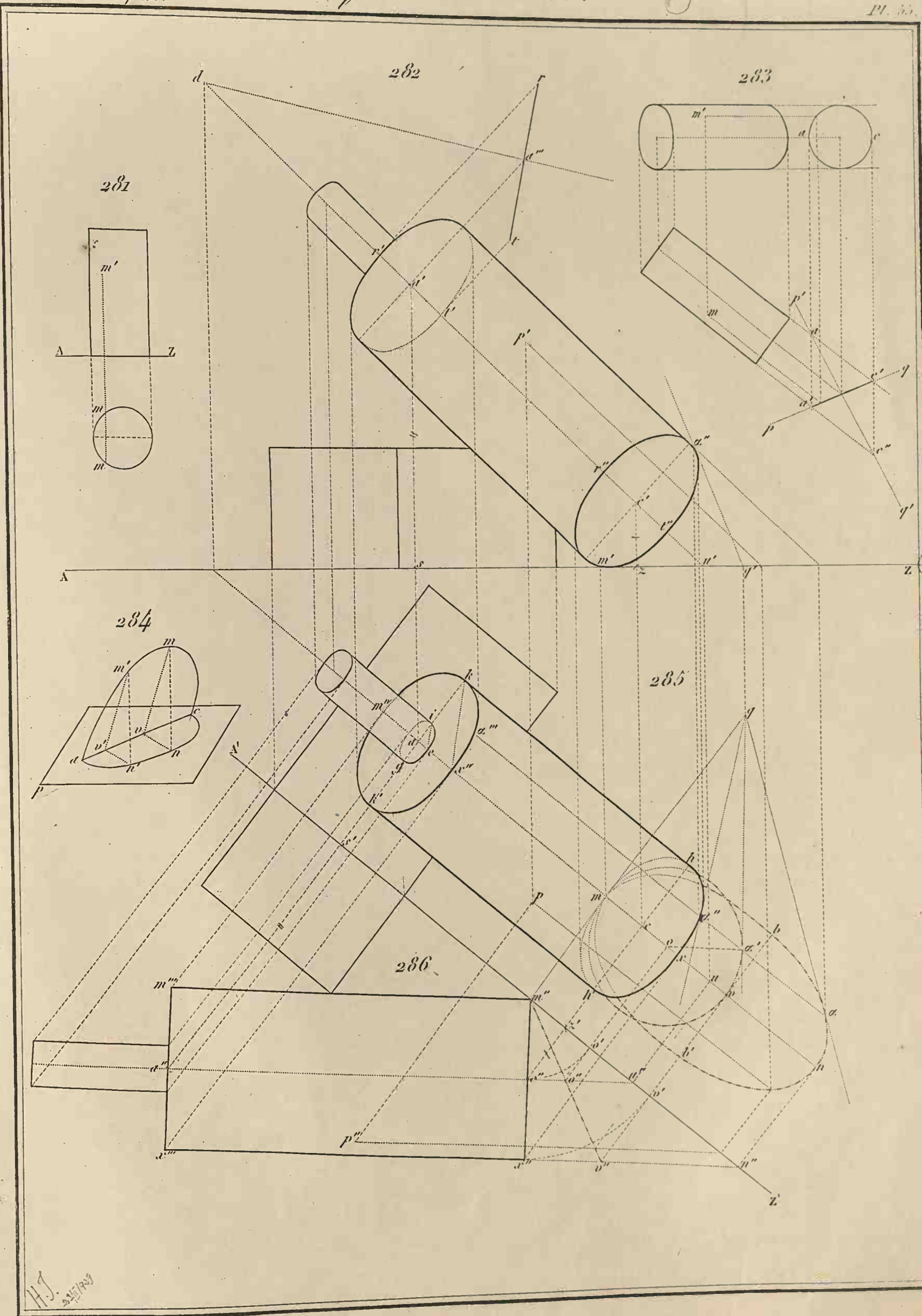

H.J. 24/12/23

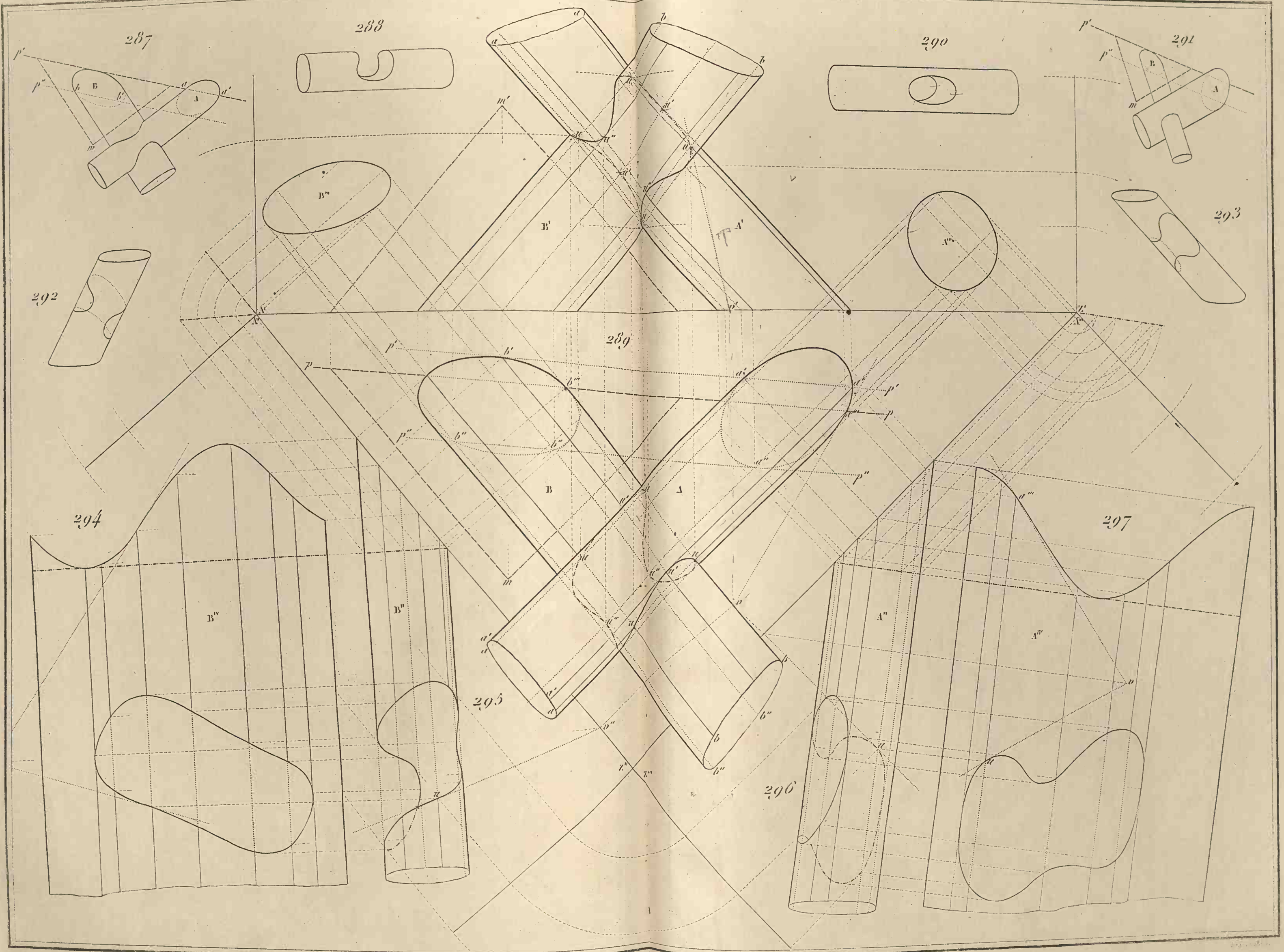

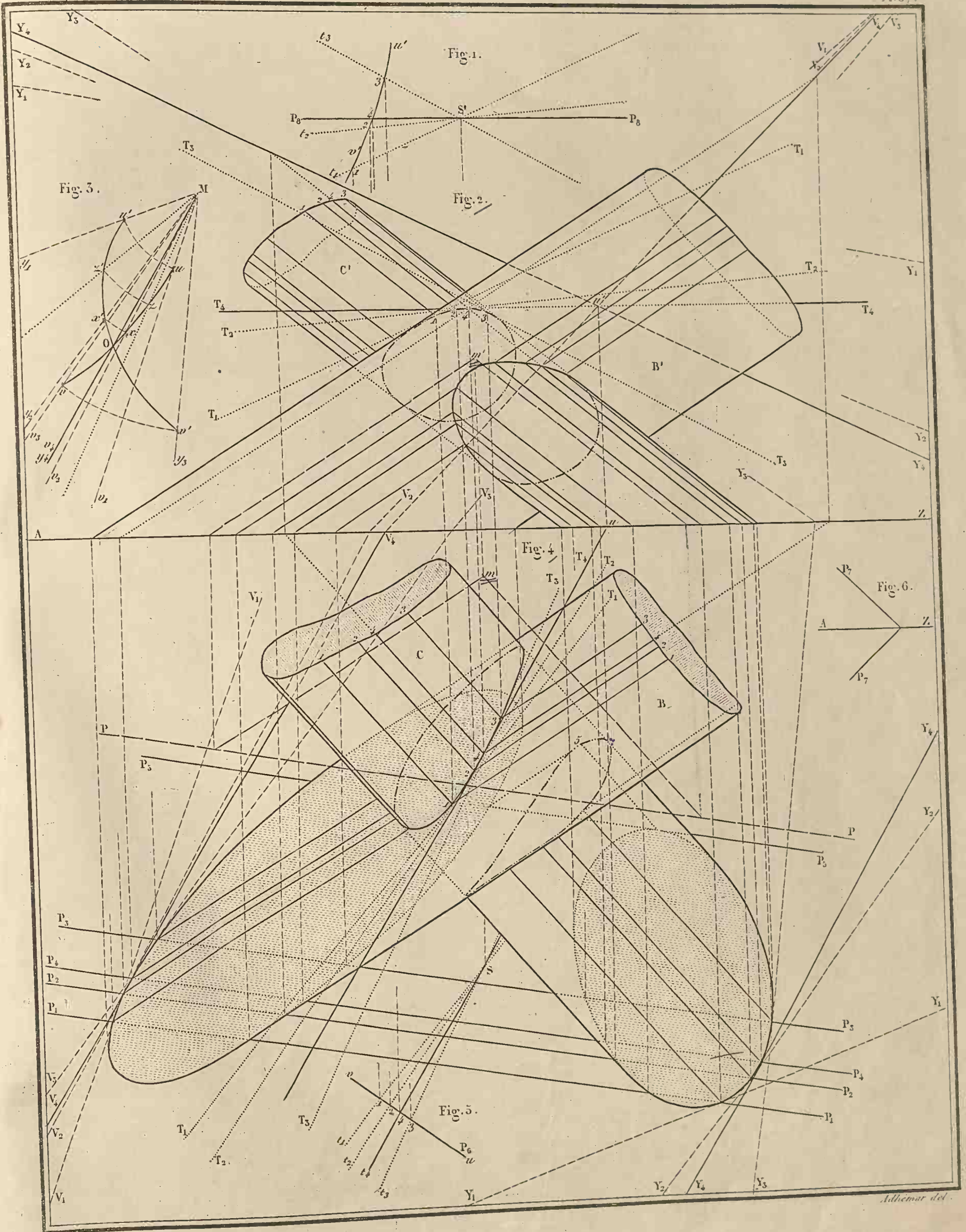

298

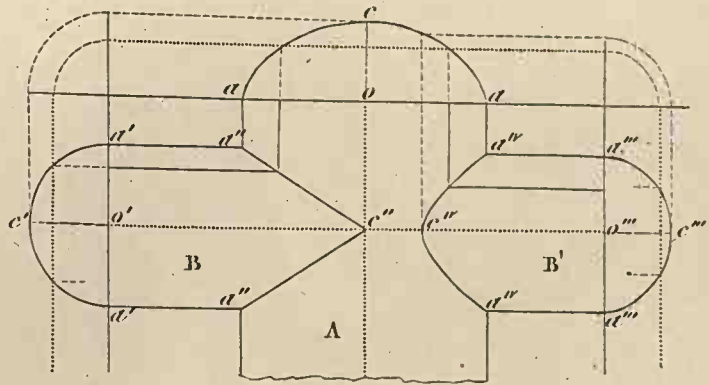

299

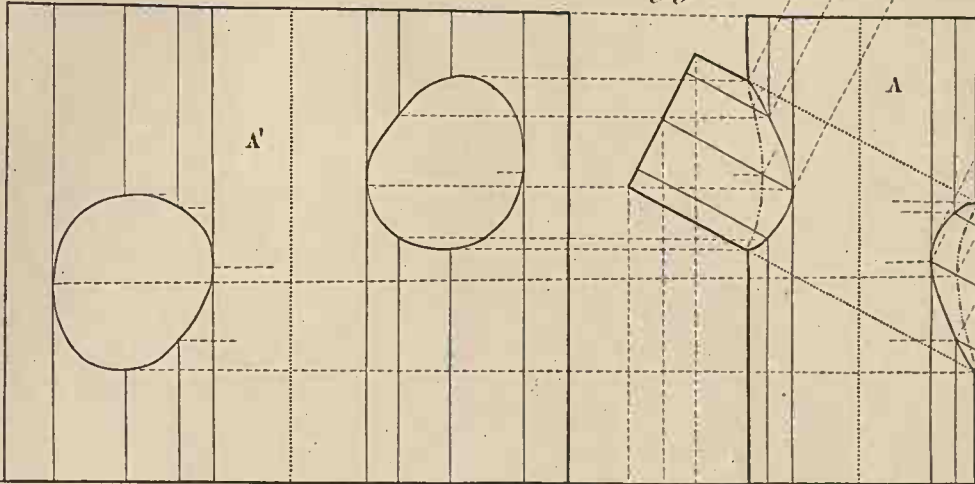

300

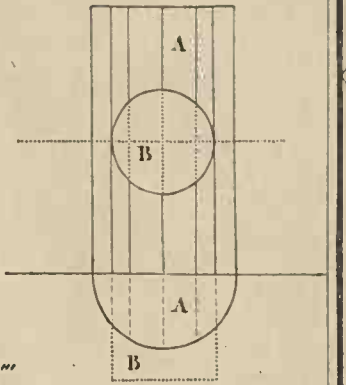

301

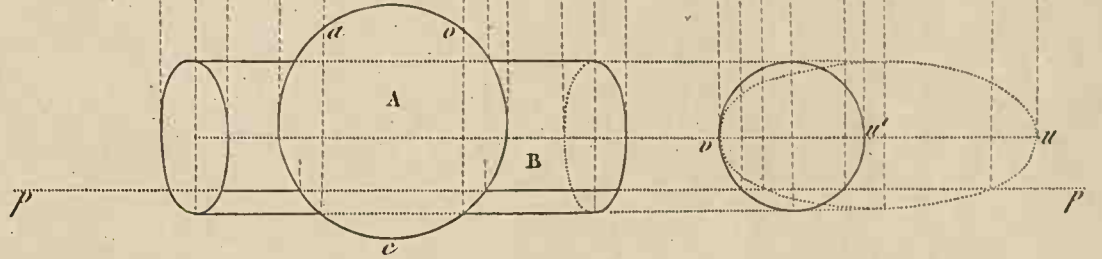
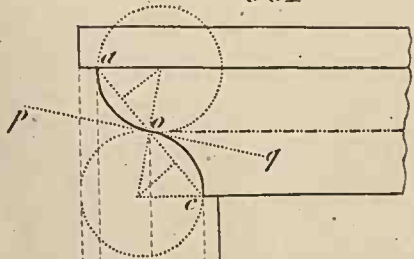

303

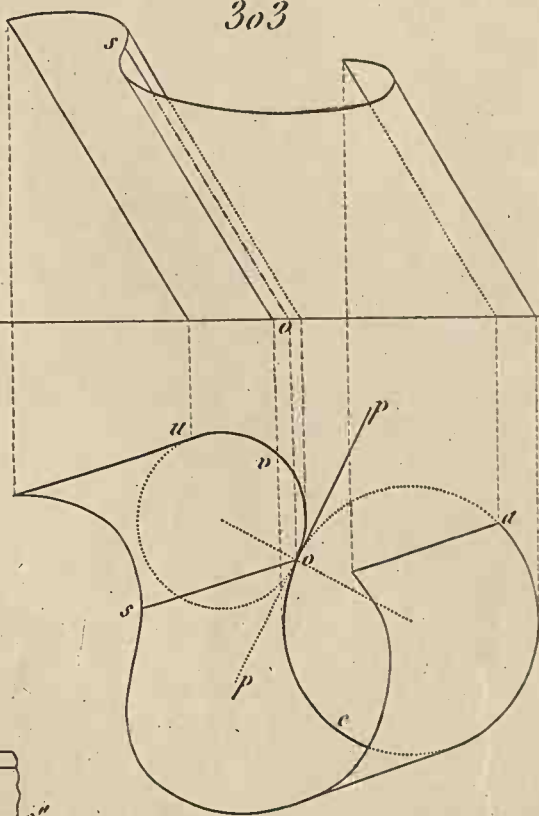

304

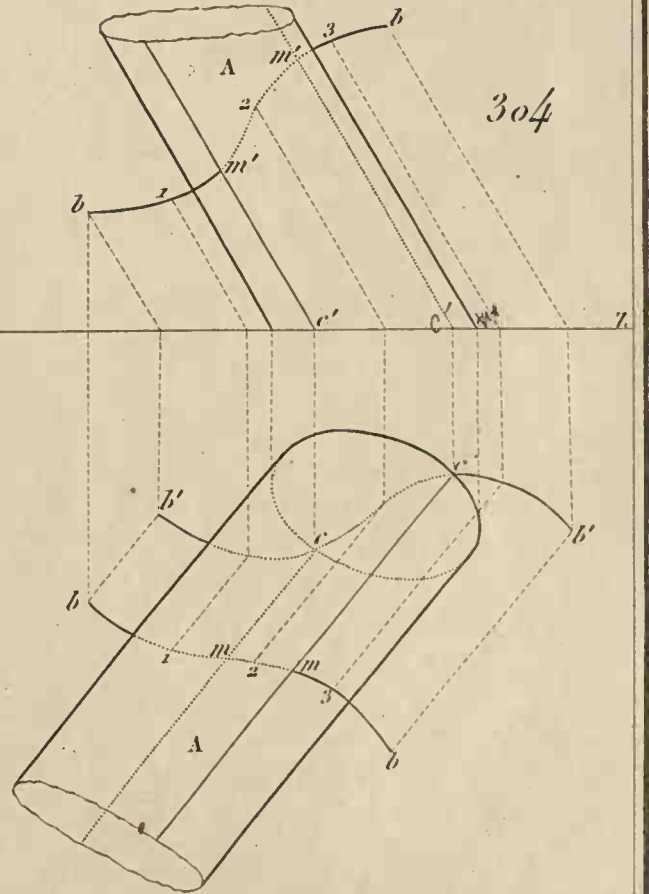

302

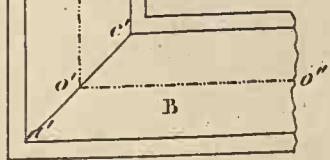

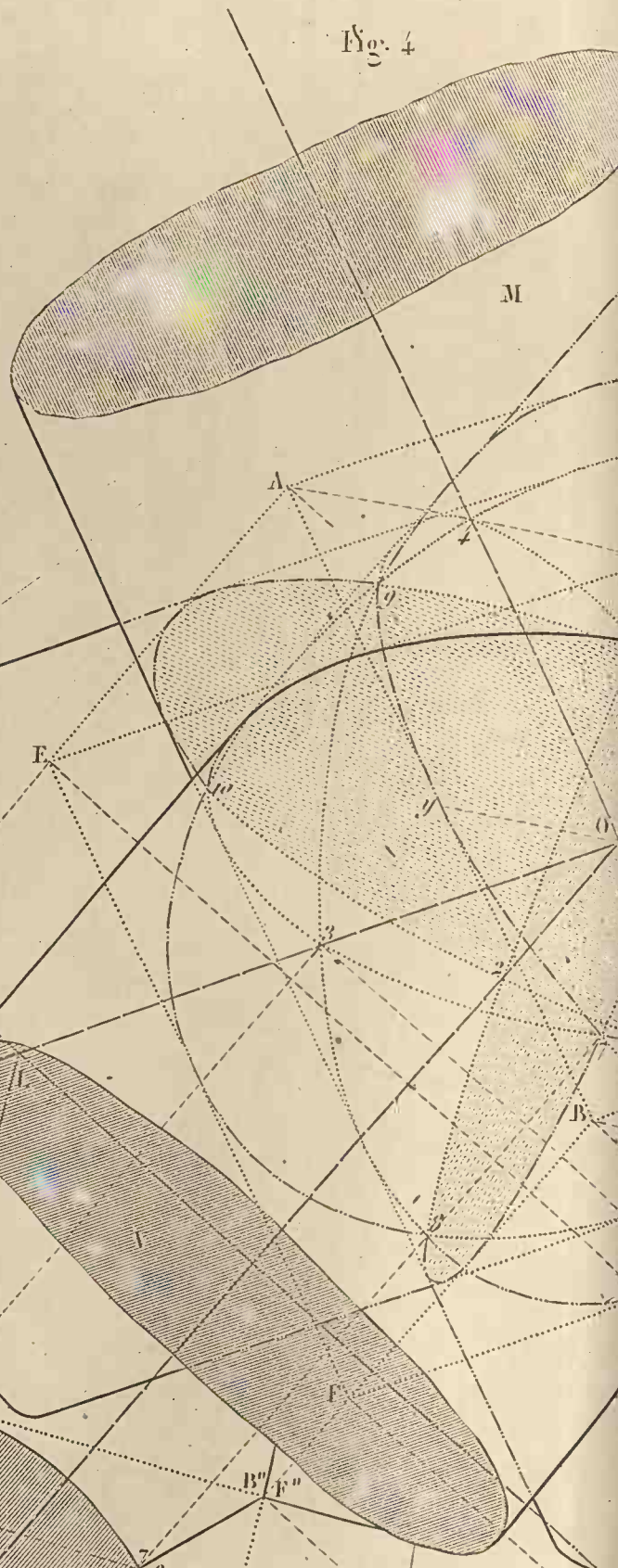
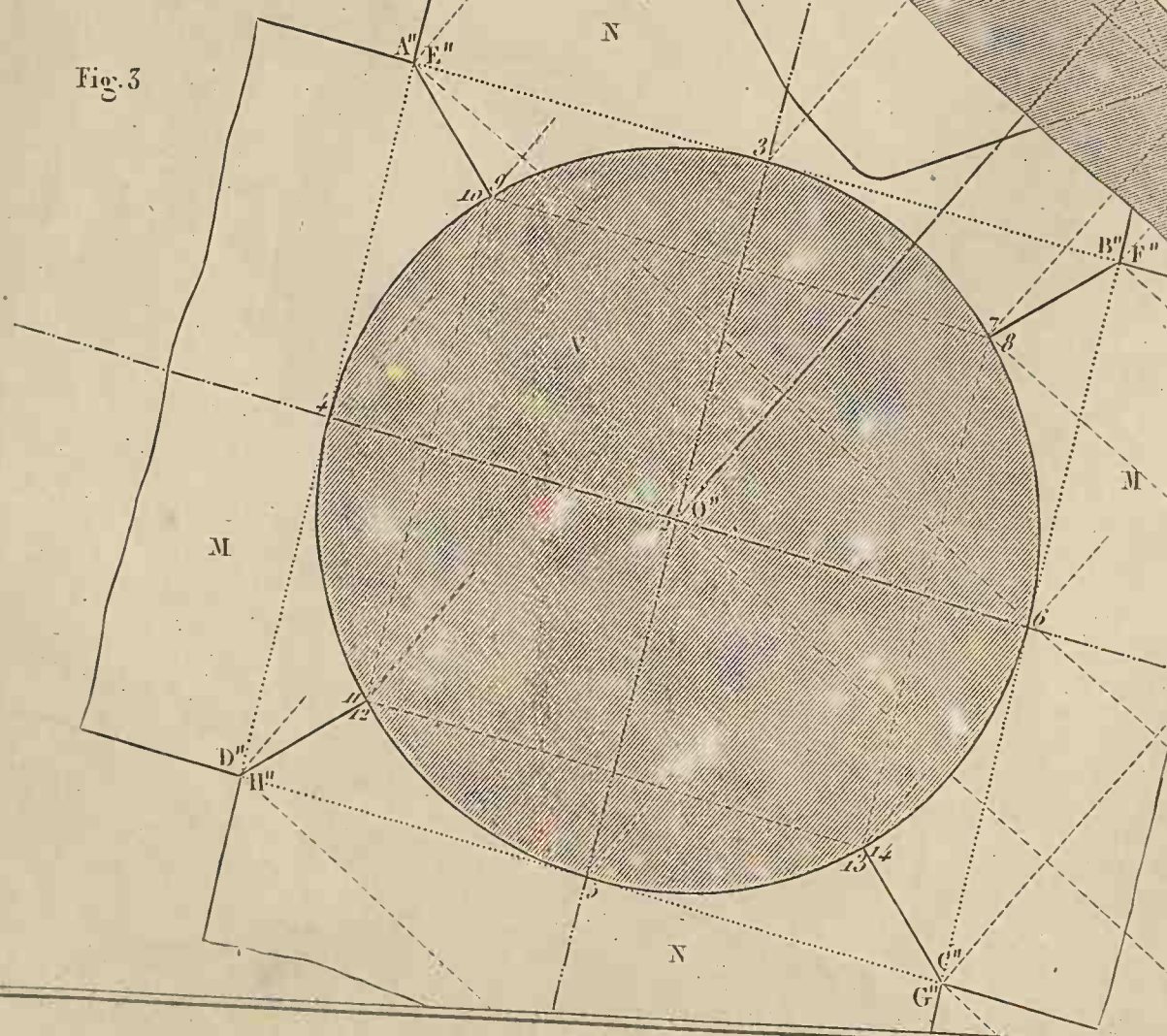
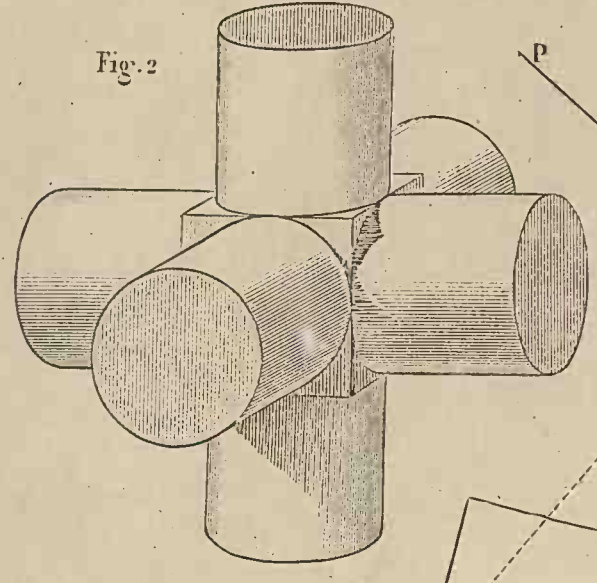
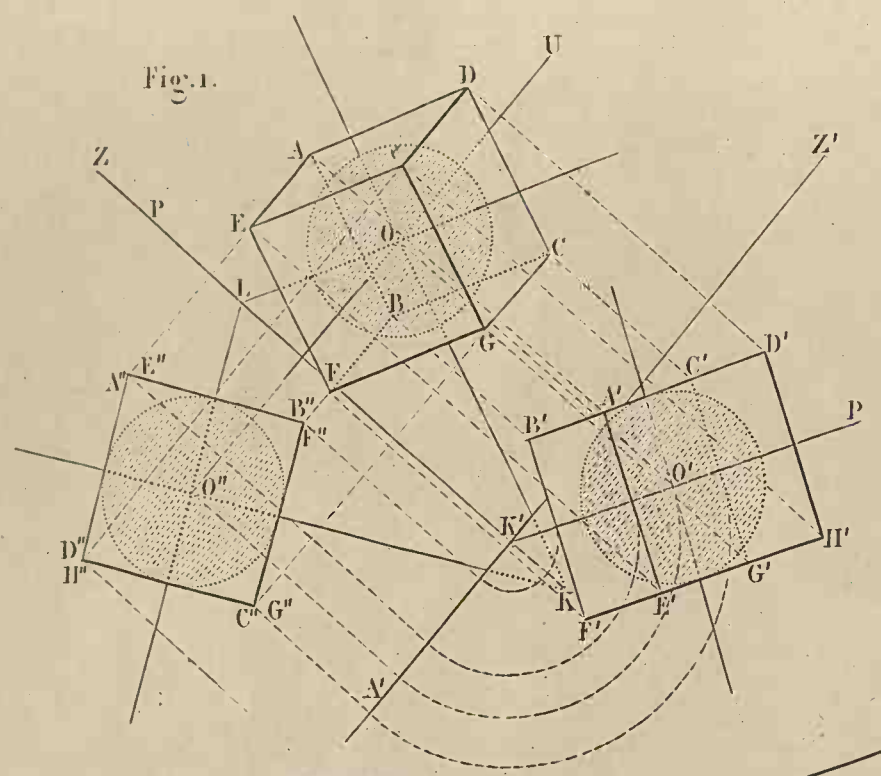

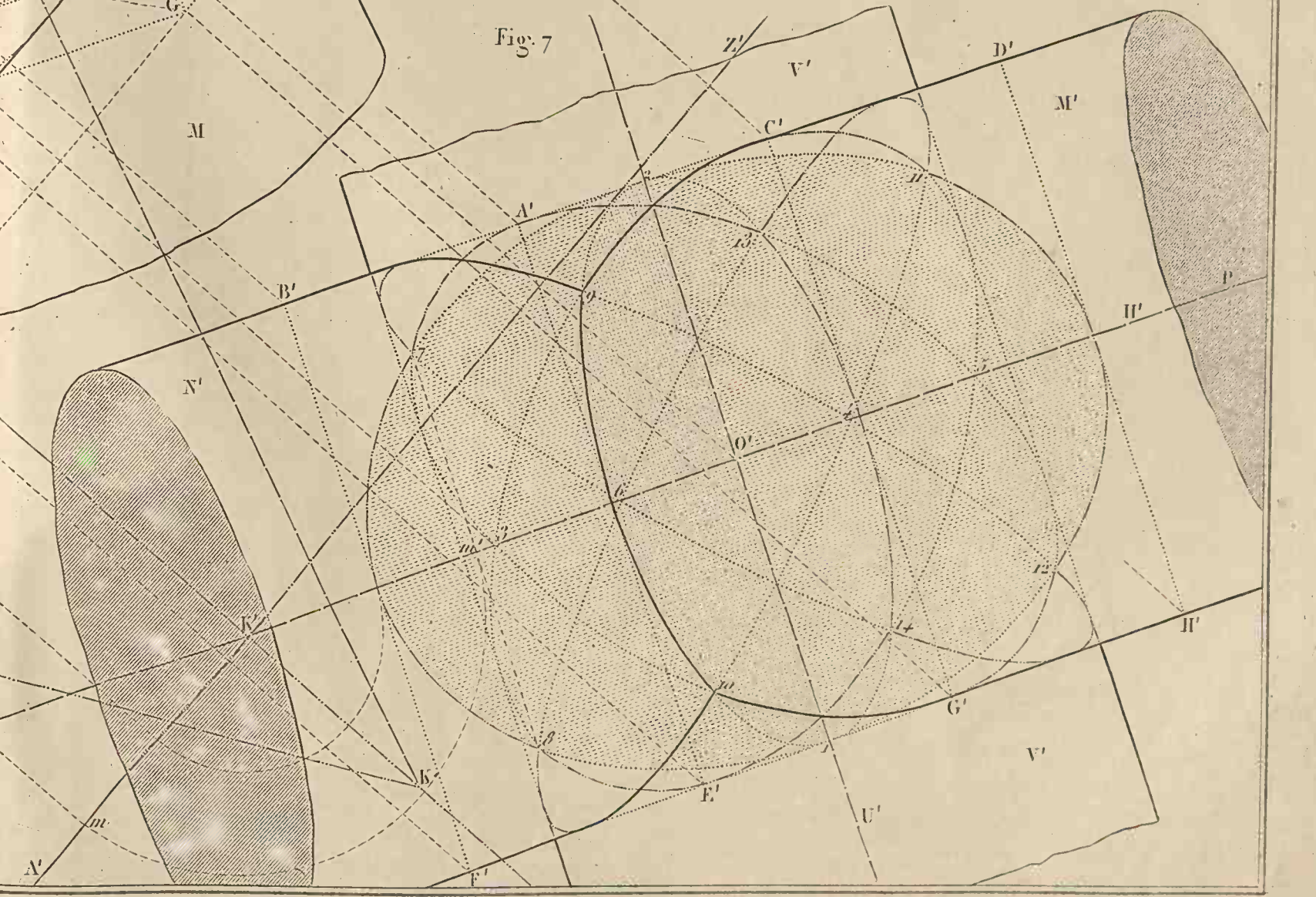
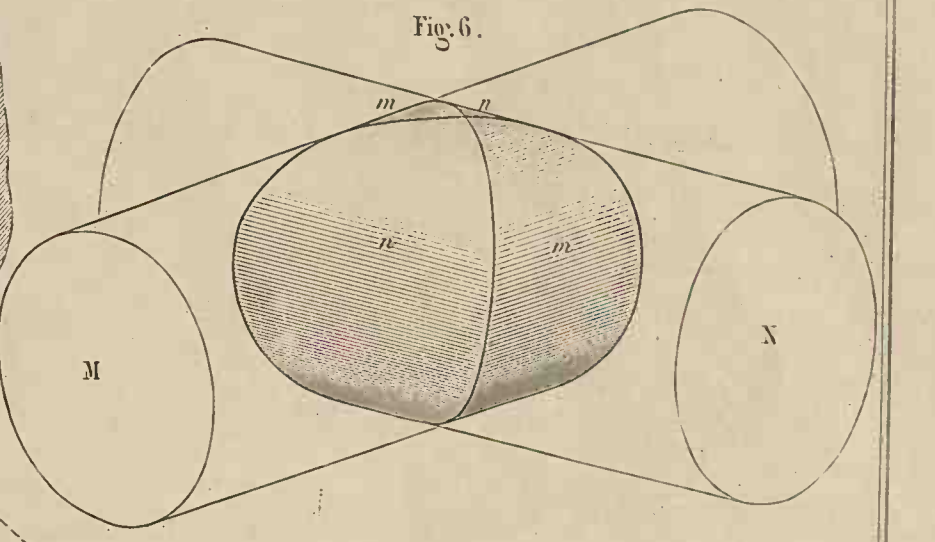
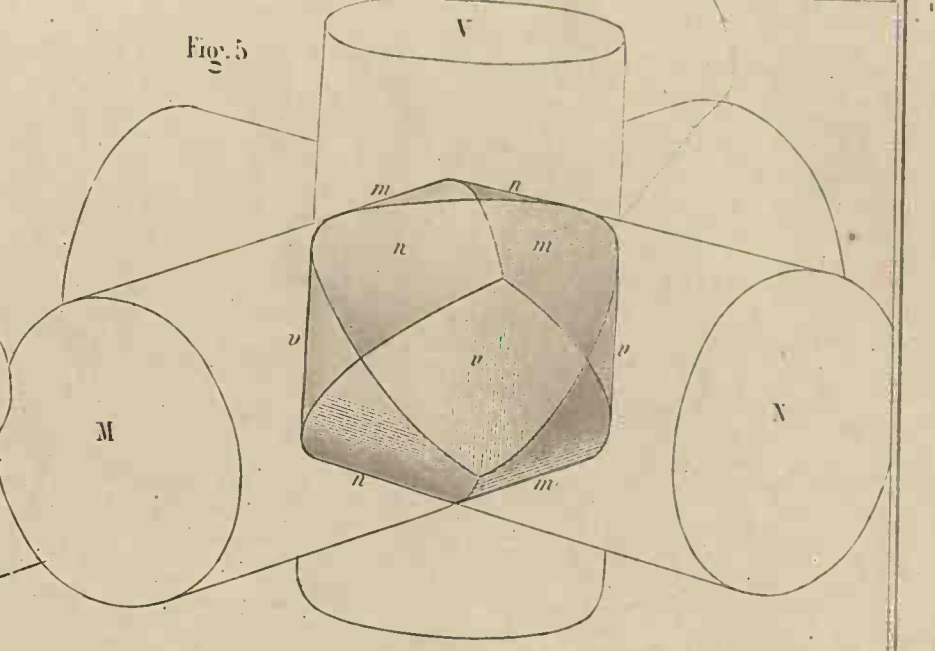
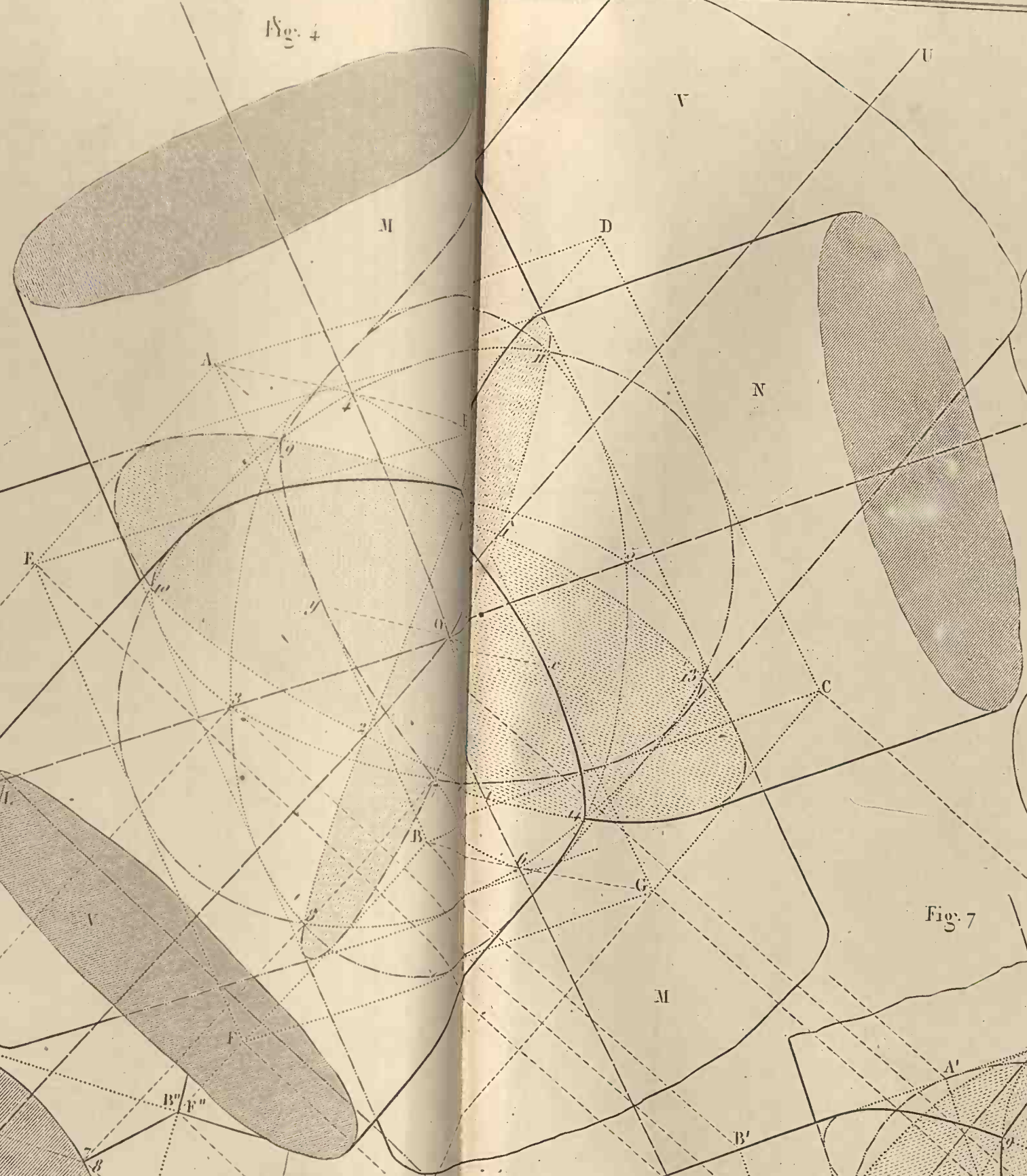
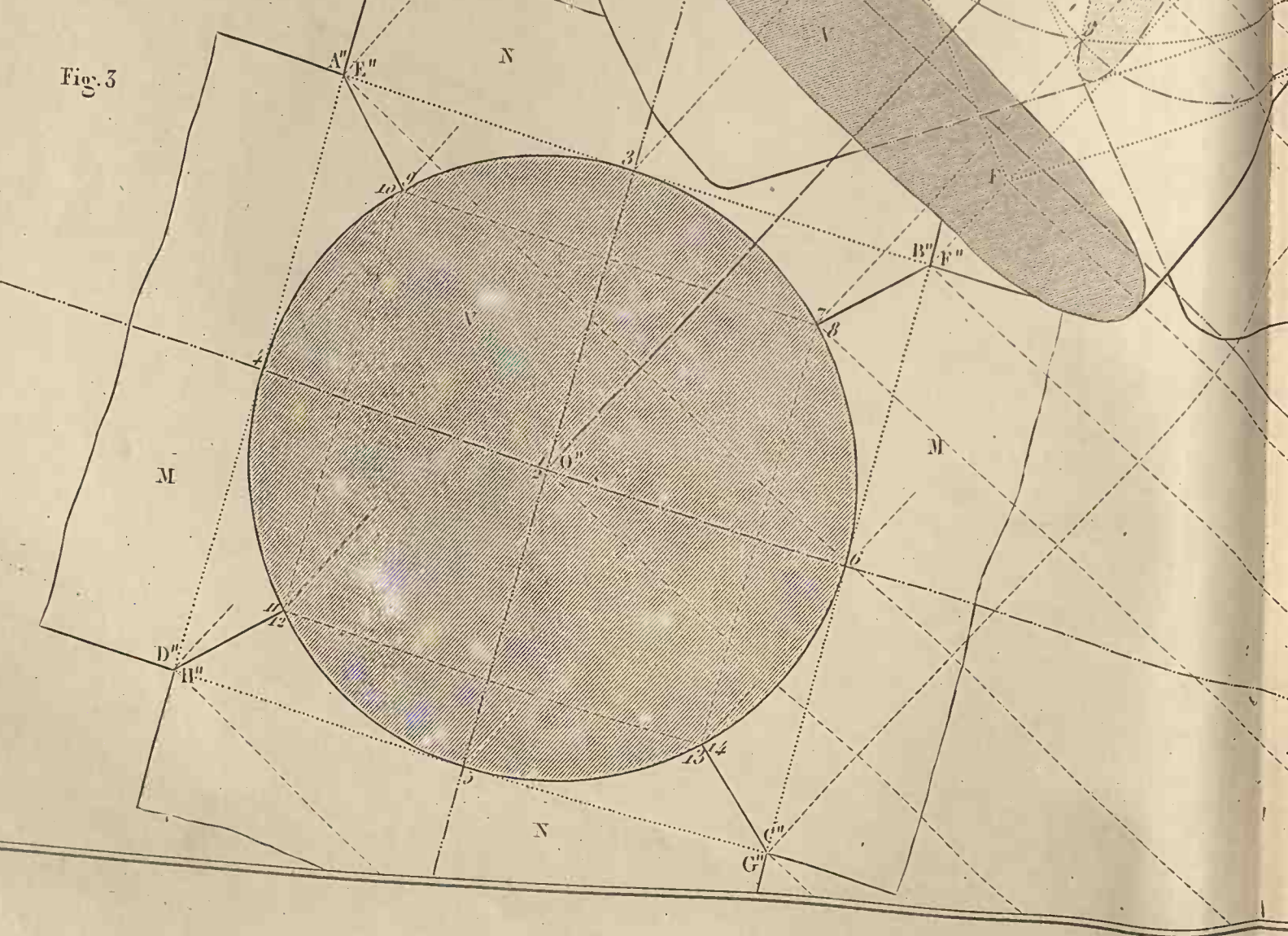
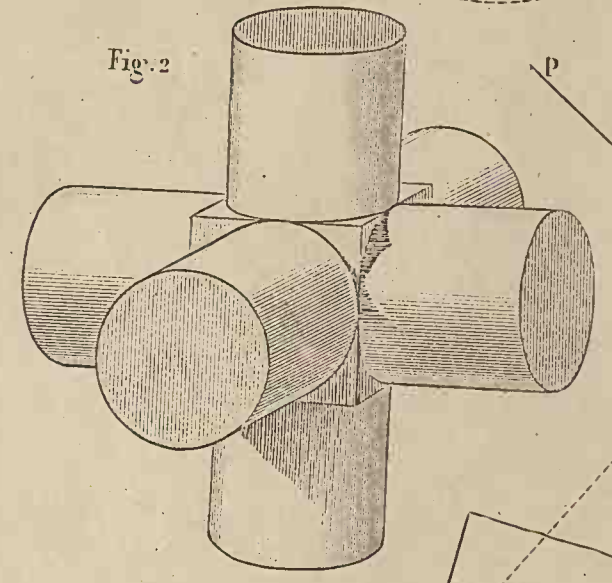
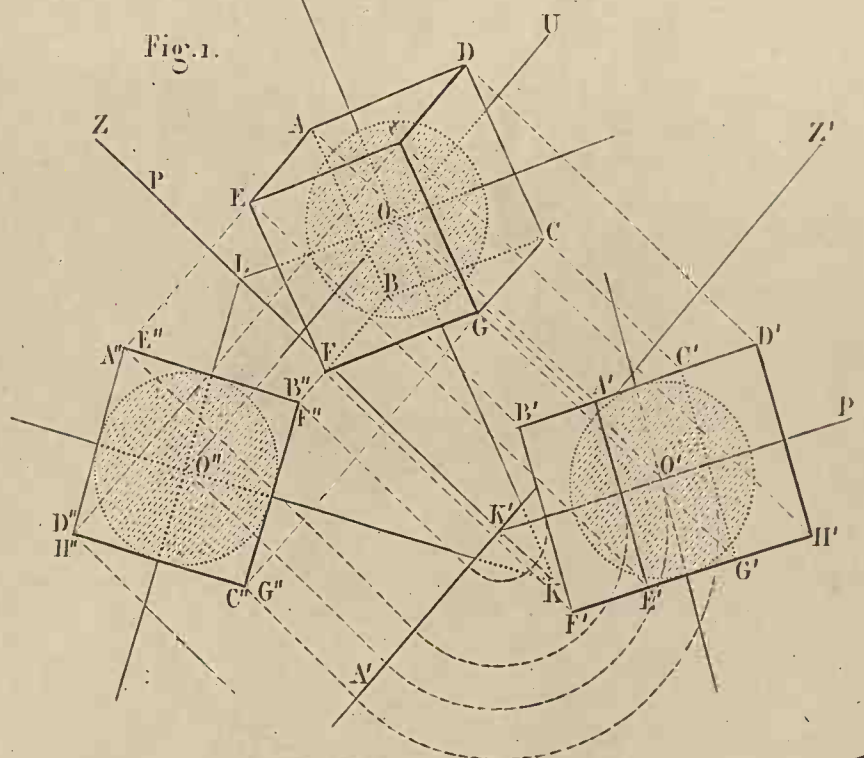

Développement du Cône.

Géométrie descriptive.

Pl. 60.

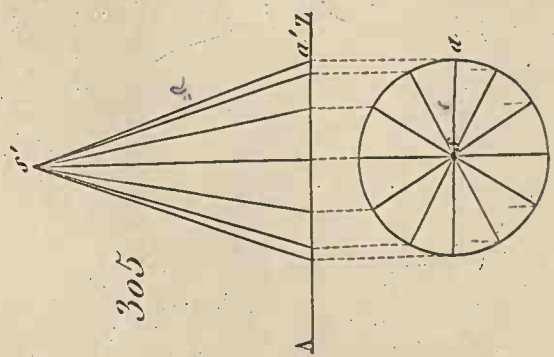

305

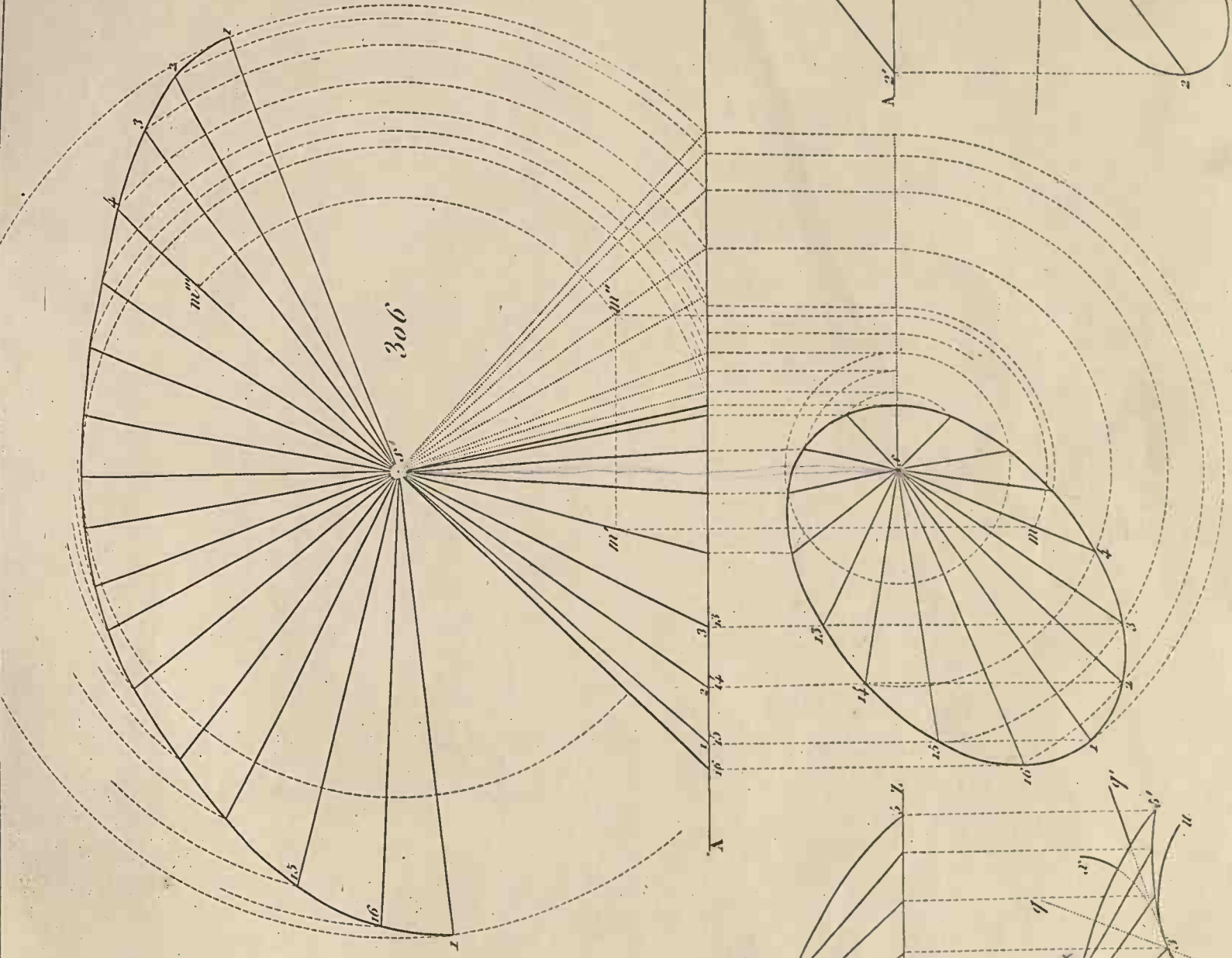

306

307

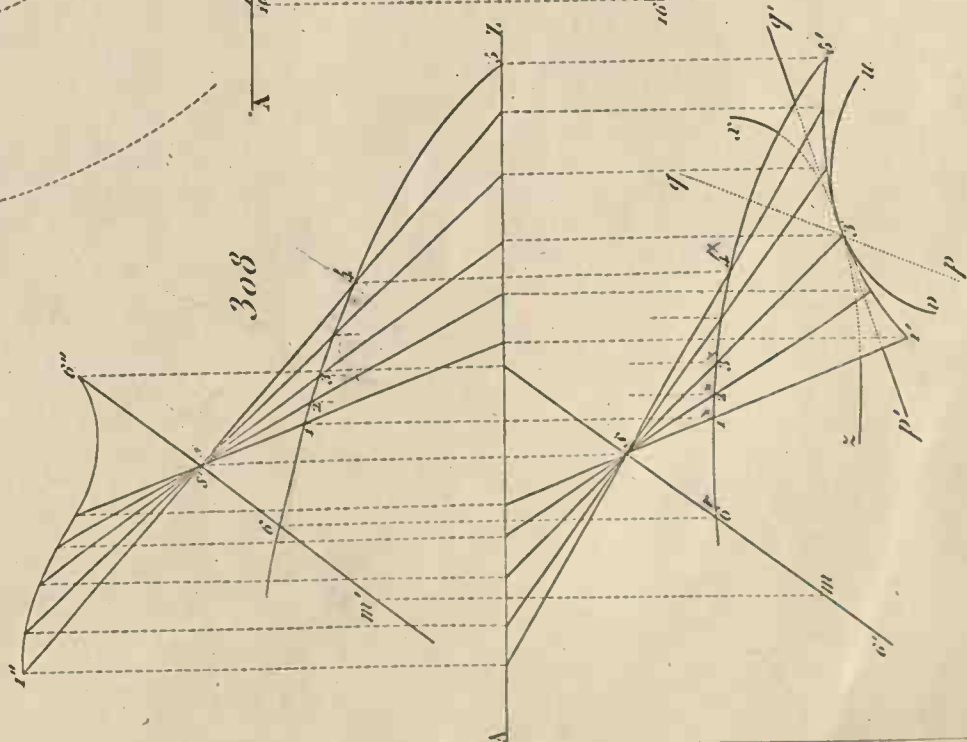
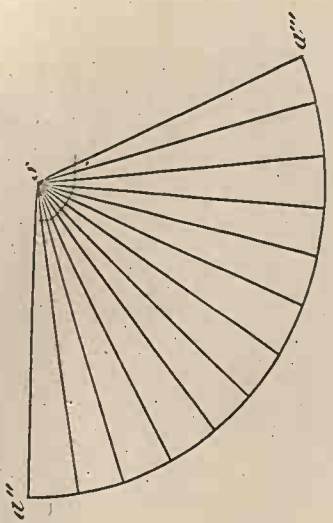

308

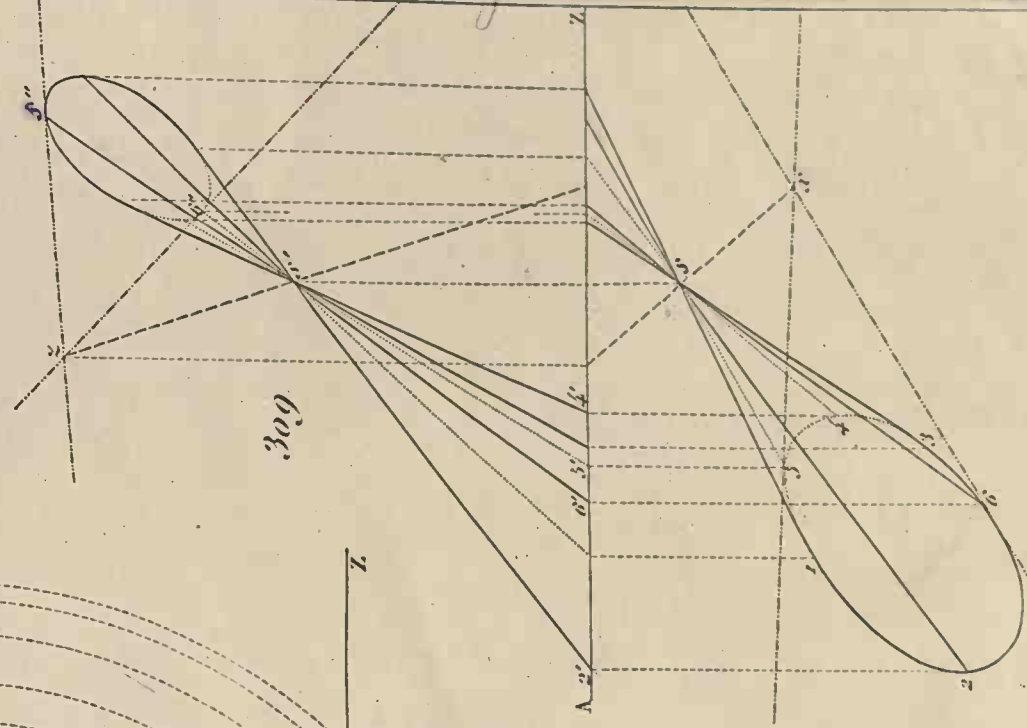

309

Plans passant par le sommet du Cône.

Géométrie descriptive.

Pl. 61.

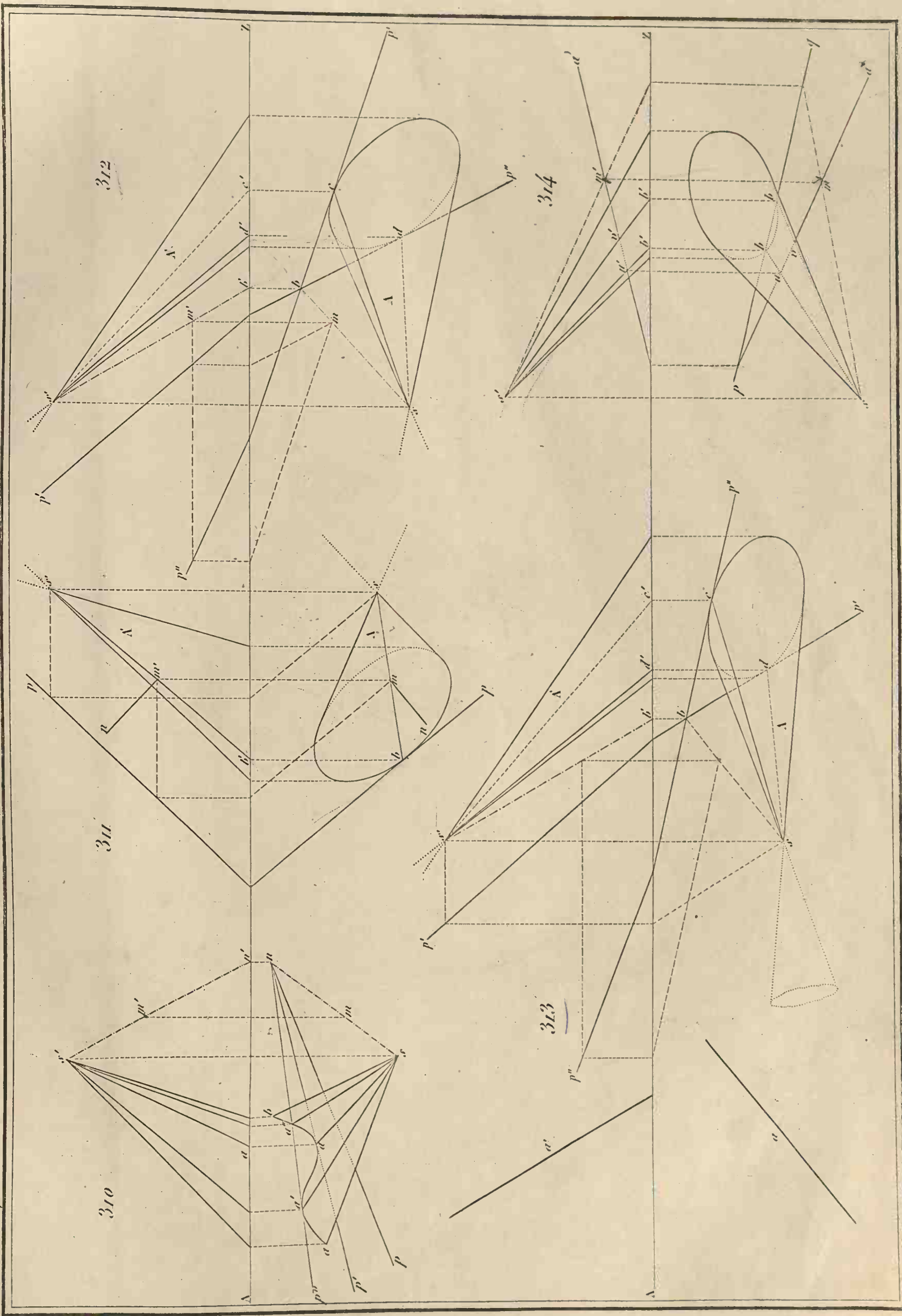

Sections planes des surfaces coniques.

Geométrie descriptive.

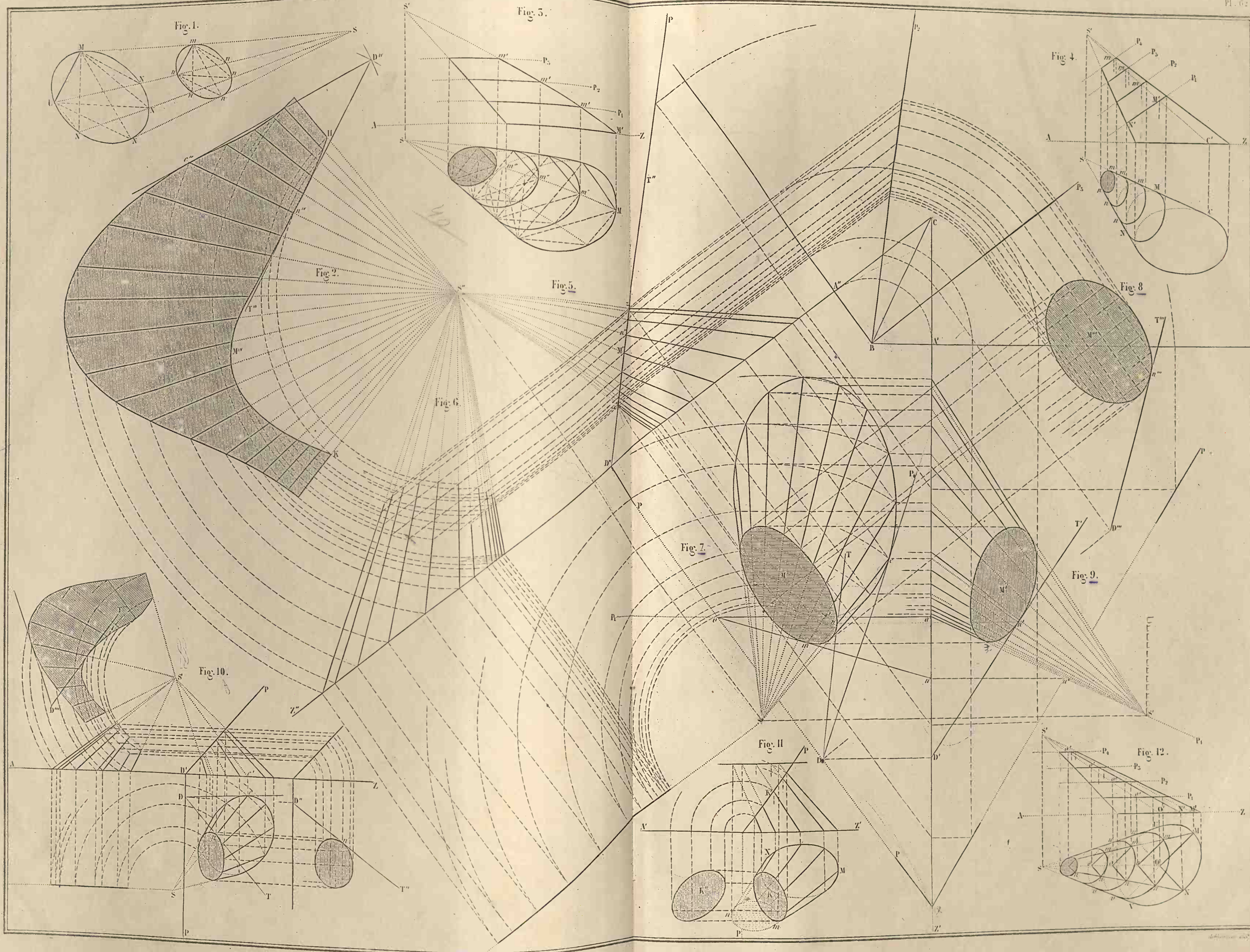

TANGENTES AUX COURBES DE SECTIONS

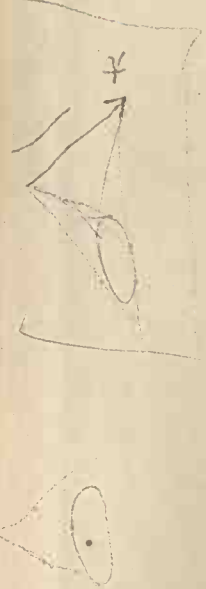
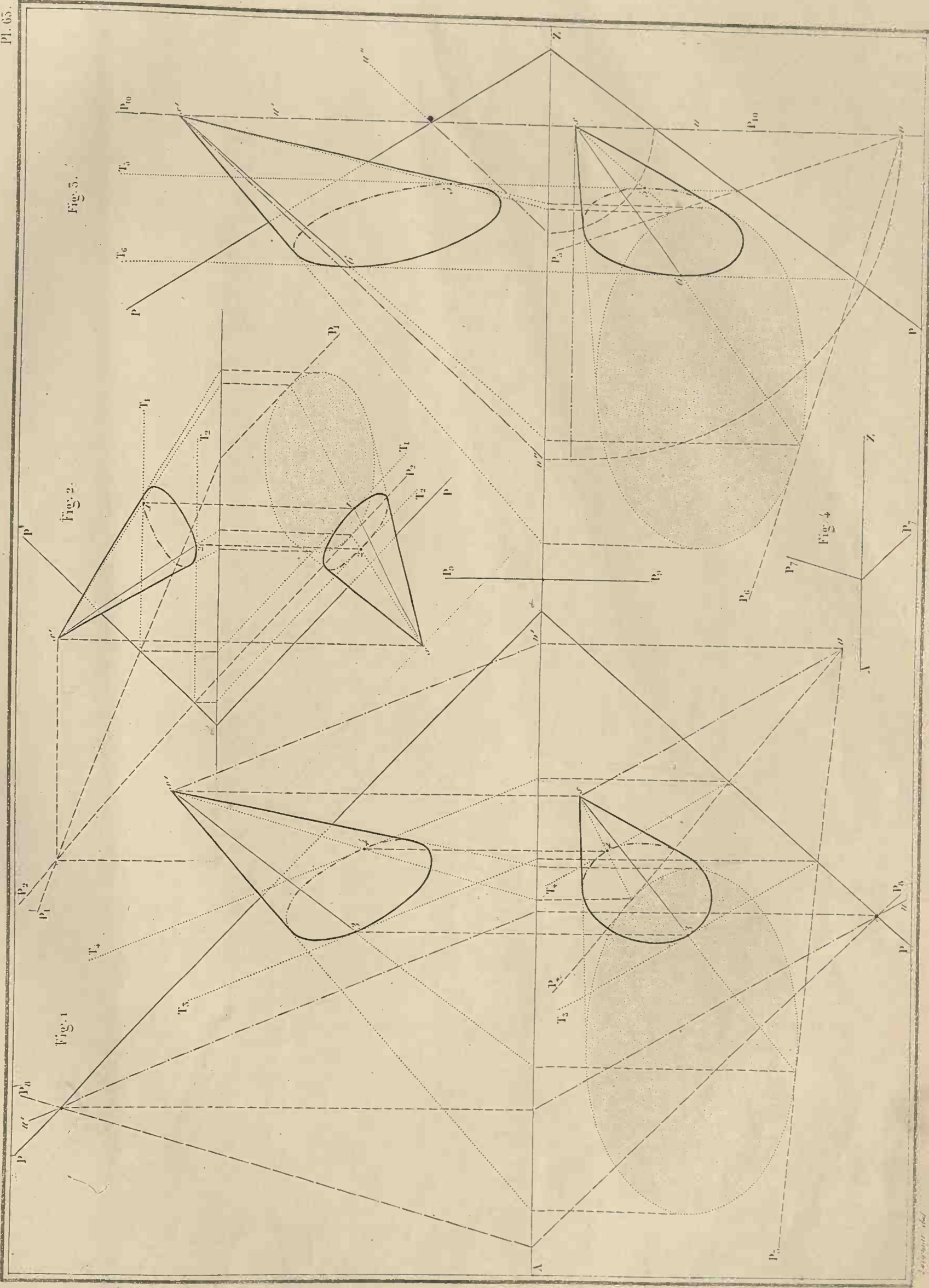

Sections planes du cône elliptique

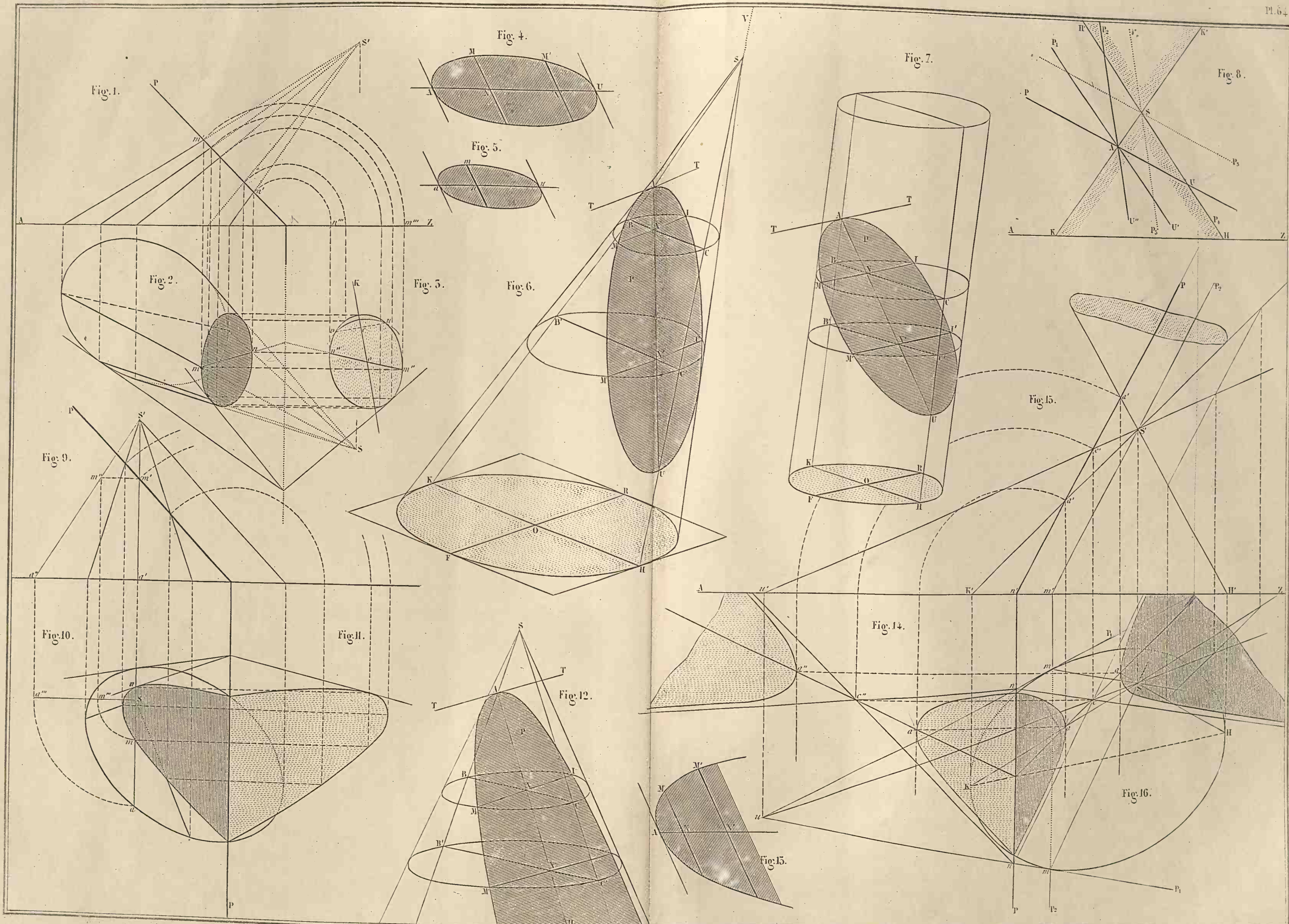

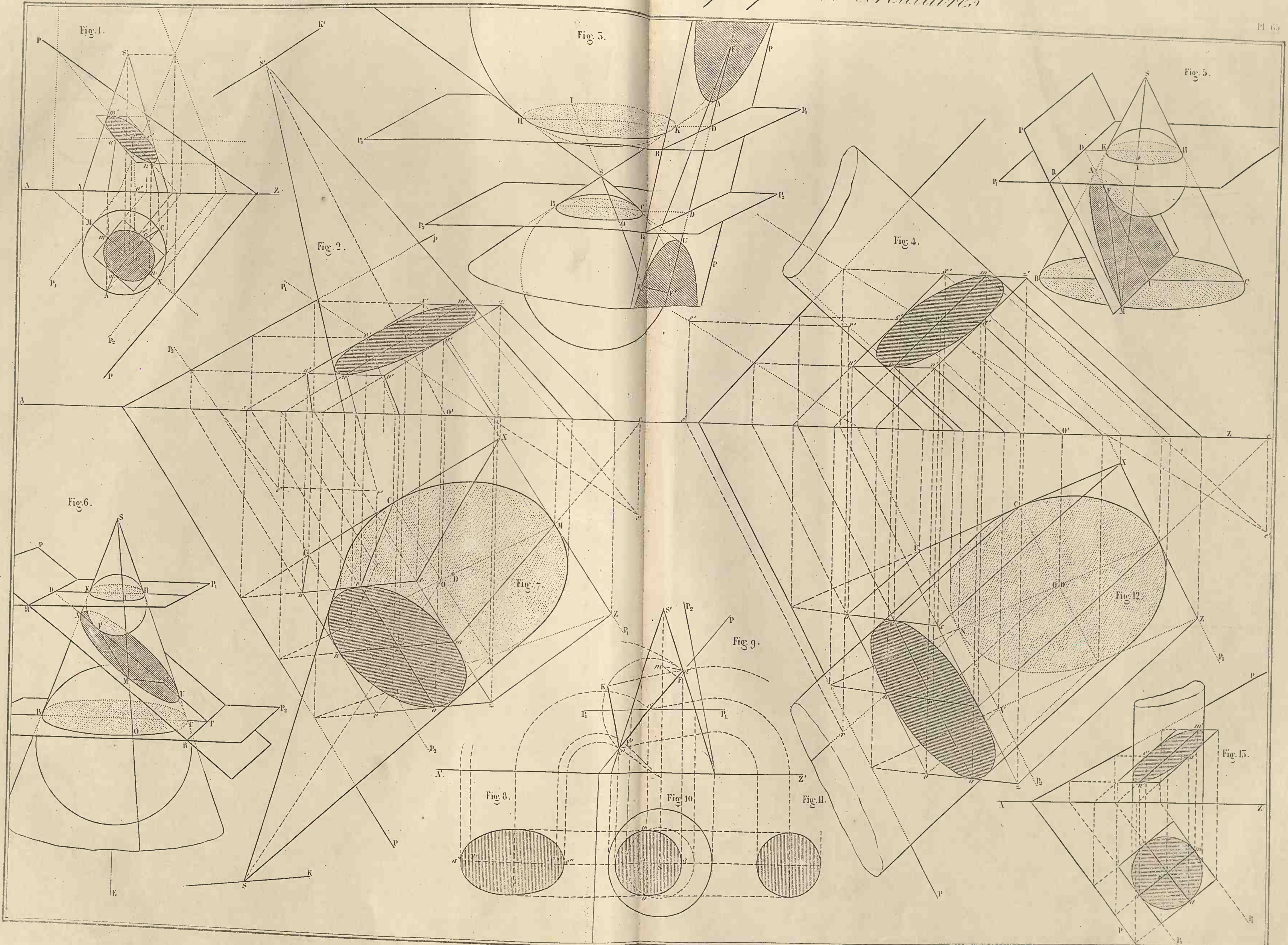

Fig. 1.

Fig. 3.

Fig. 5.

Fig. 2.

Fig. 4.

Fig. 6.

Fig. 7.

Fig. 12.

Fig. 8.

Fig. 10.

Fig. 11.

Fig. 15.

Cône circulaire.

Géométrie descriptive.

Pl. 66.

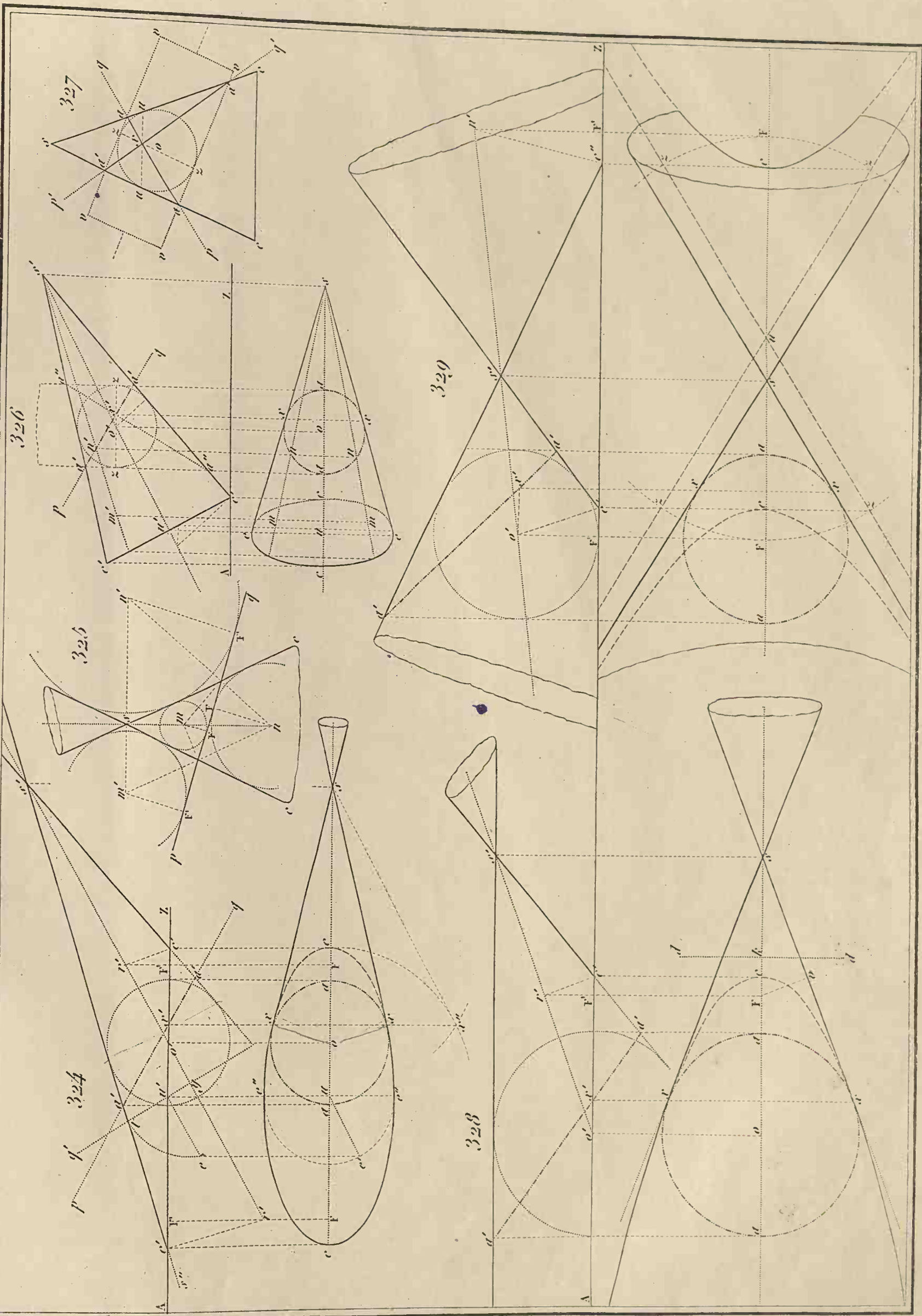

Intersections de cônes et cylindres.

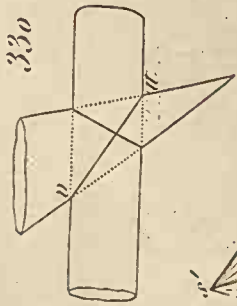

330

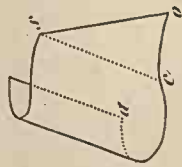

331

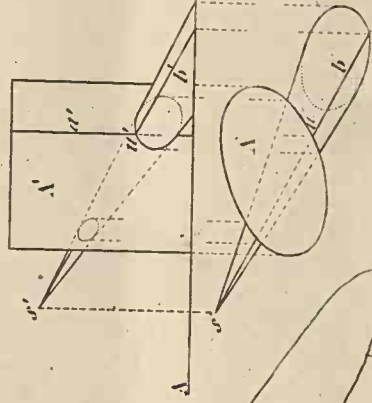

332

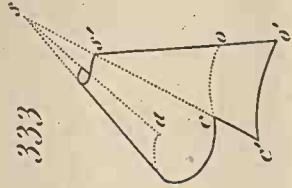

333

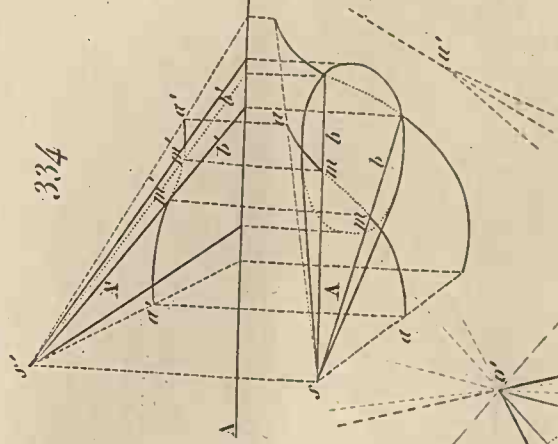

334

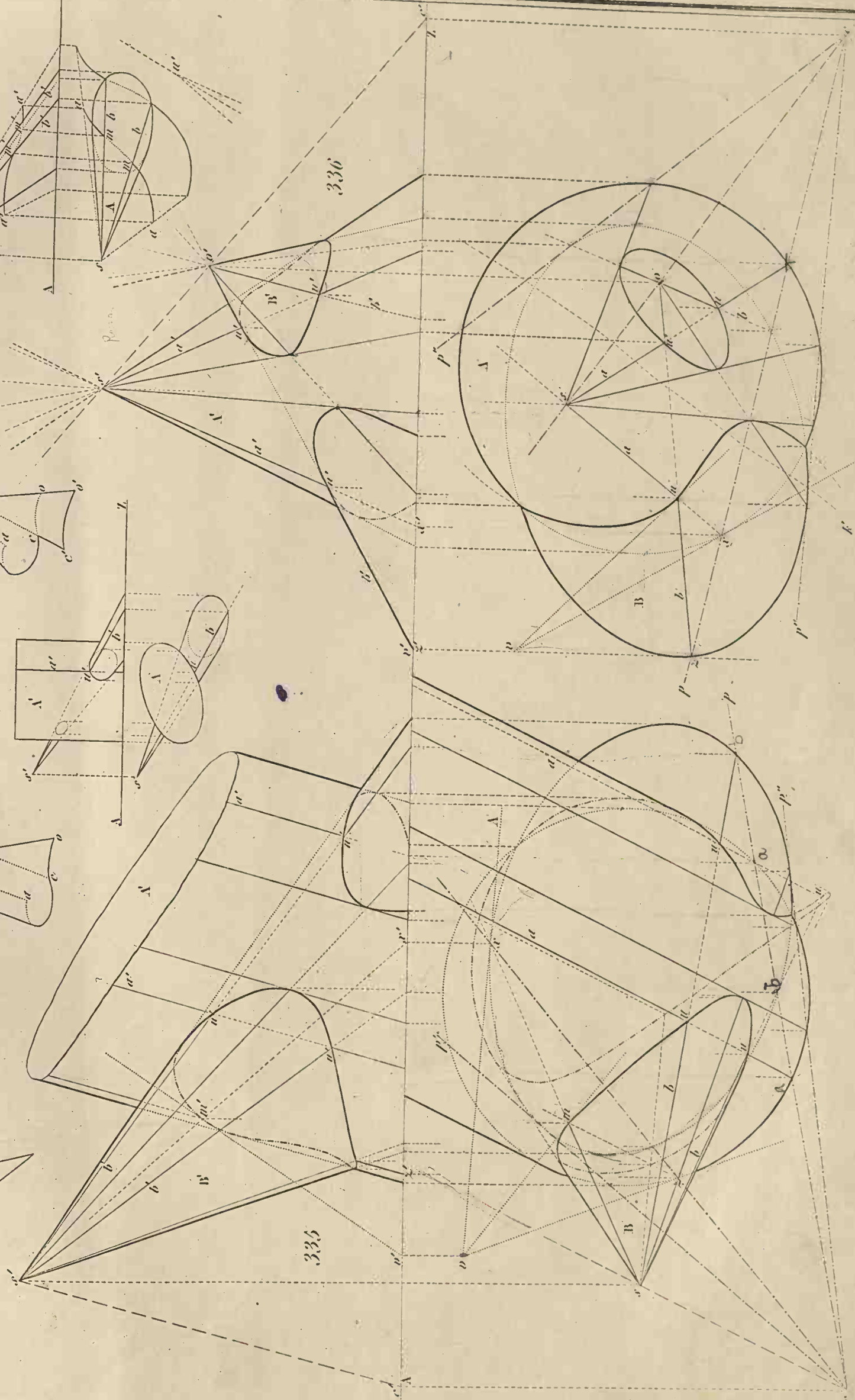

335

336

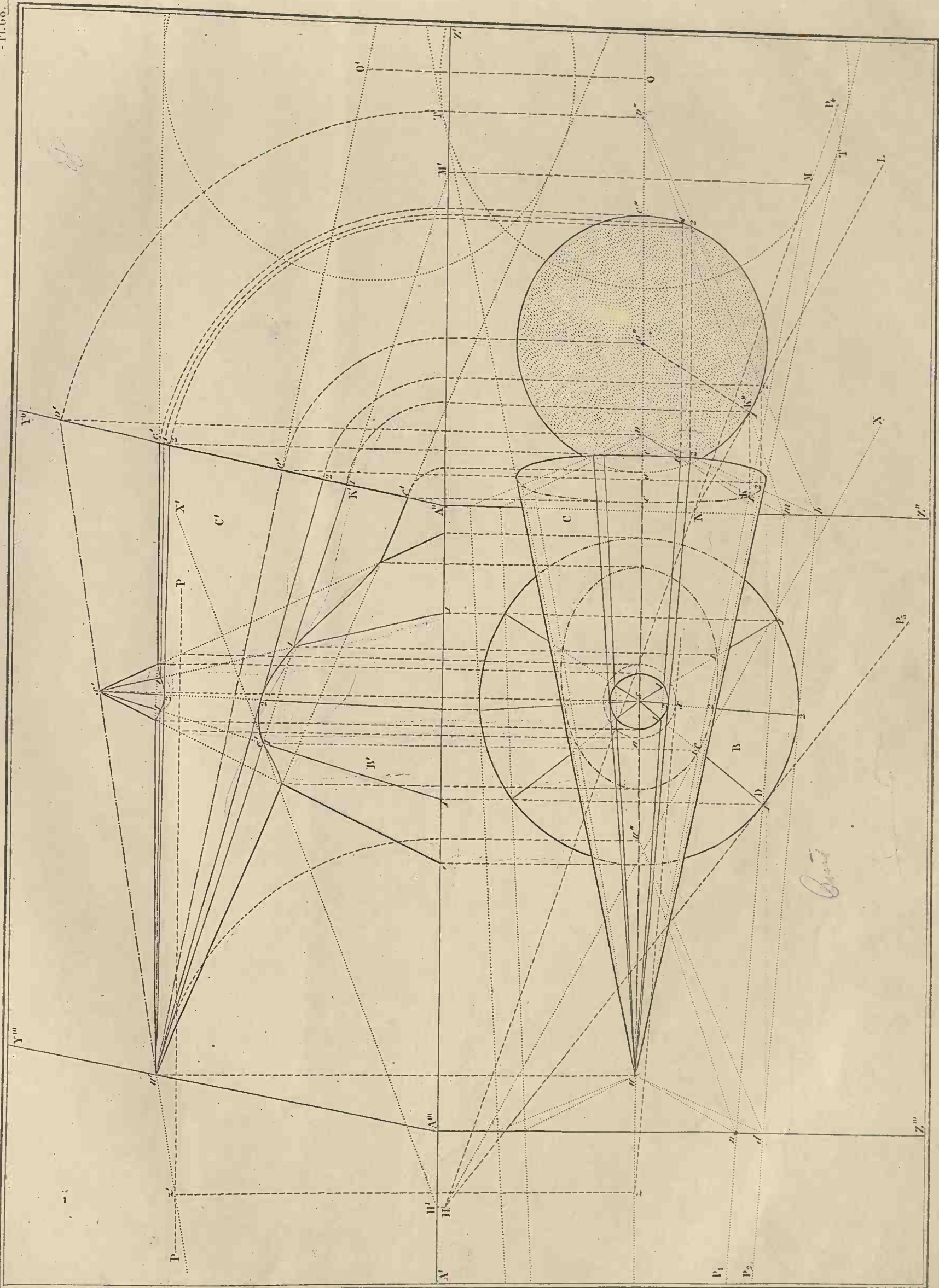

Intersections des

INTERSECTIONS DE CÔNES

6. descriptive.

Pl. 69.

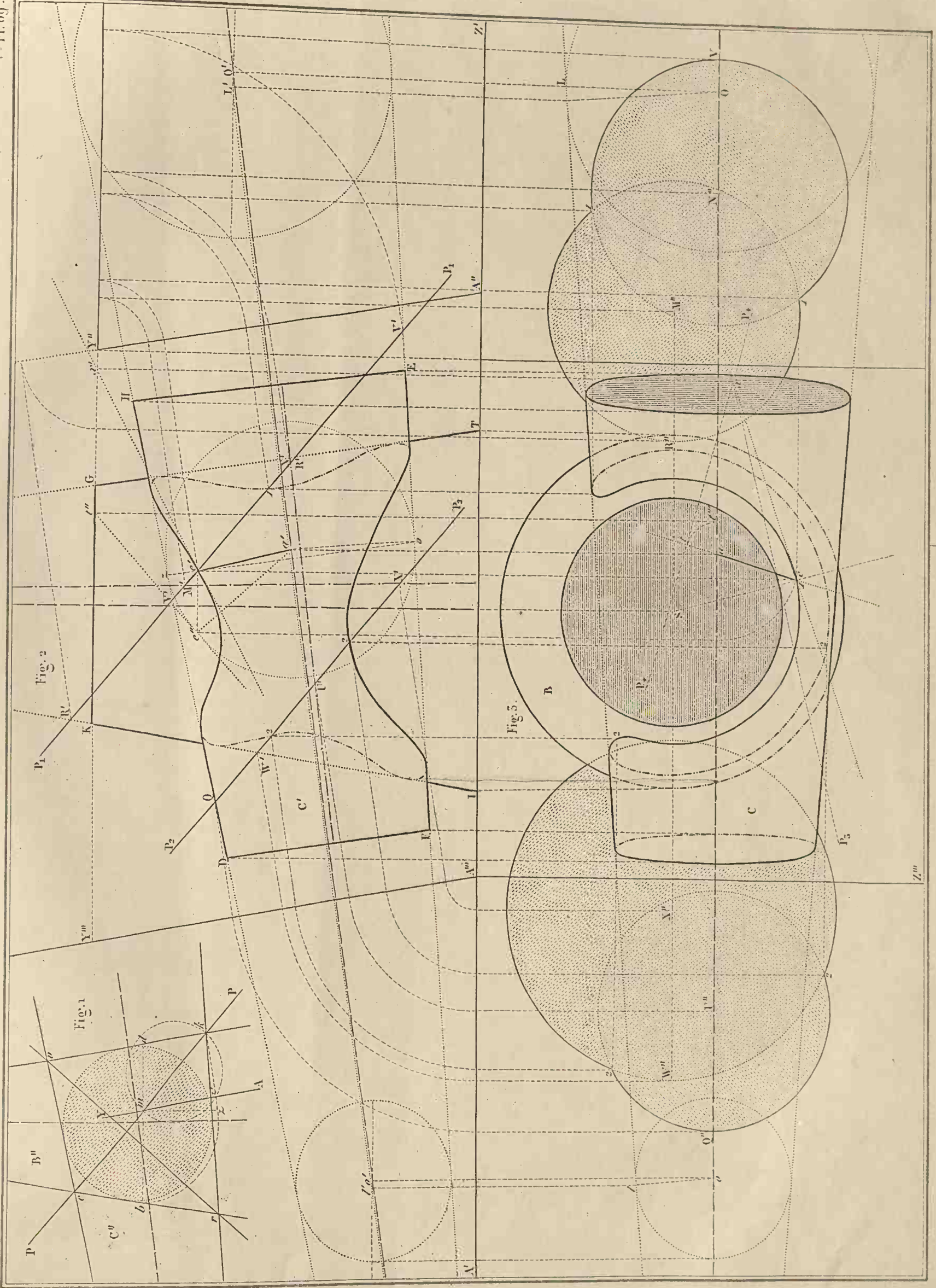

Alhambra 511

337

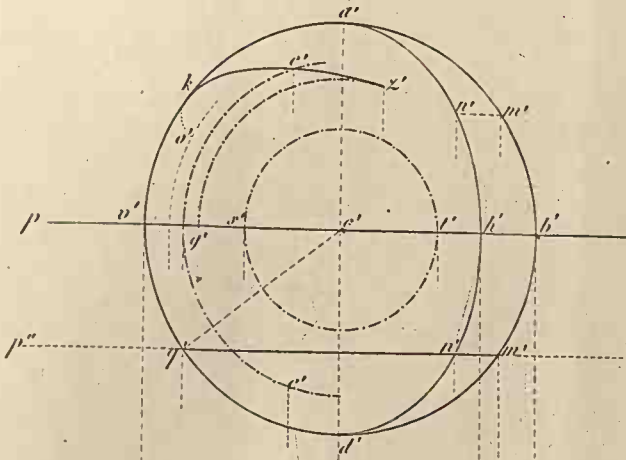

338

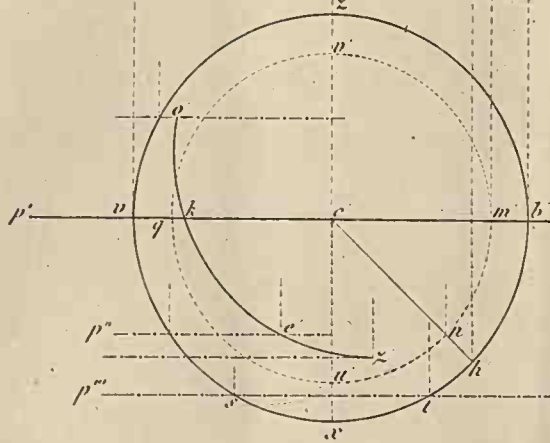
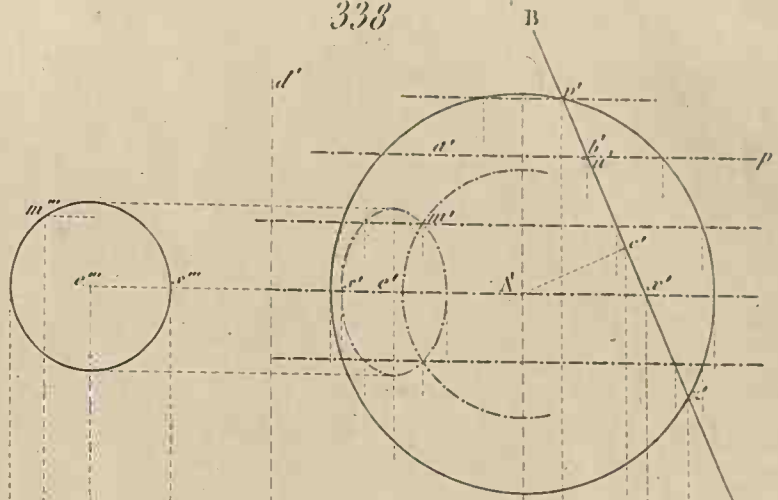

B'' m'' c'' a'' d

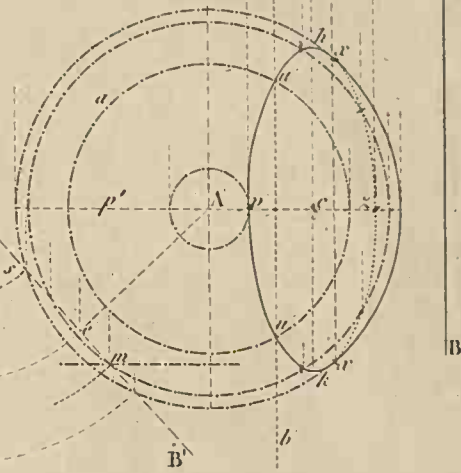

339

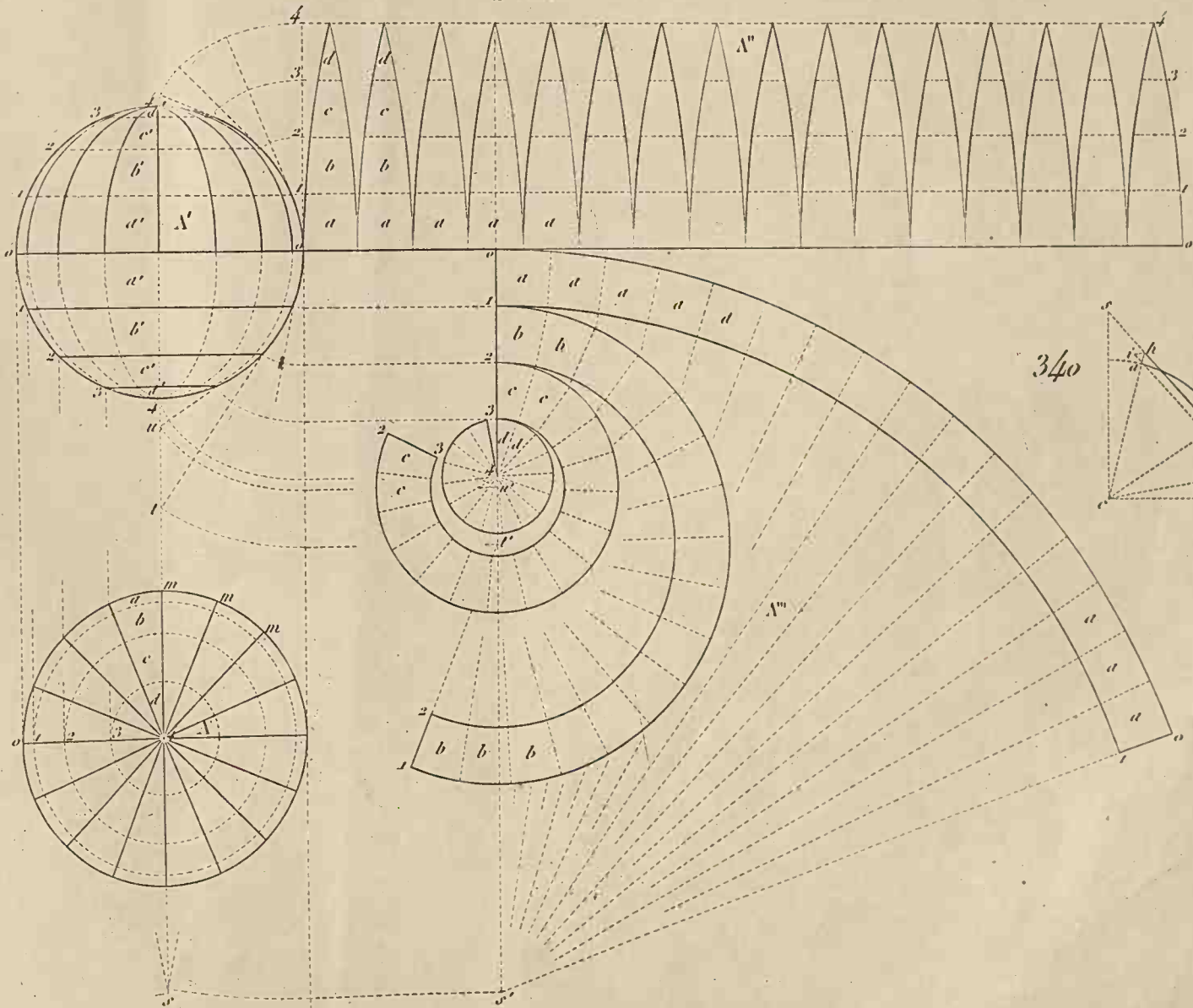

340



341

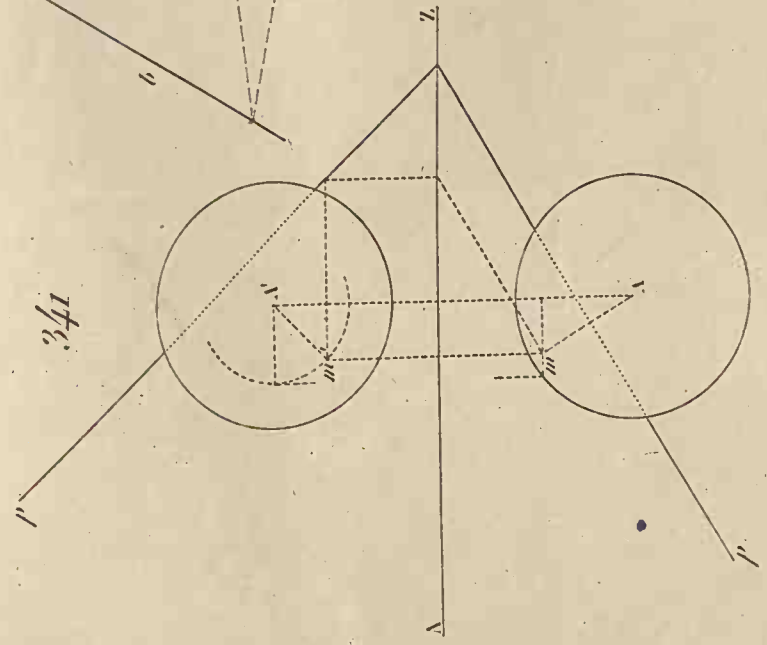

342

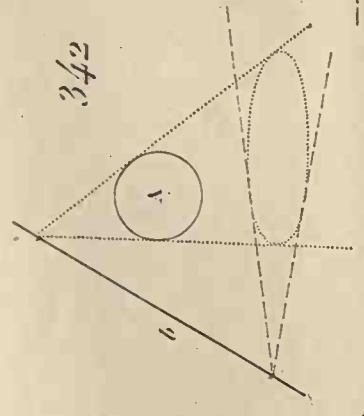

343

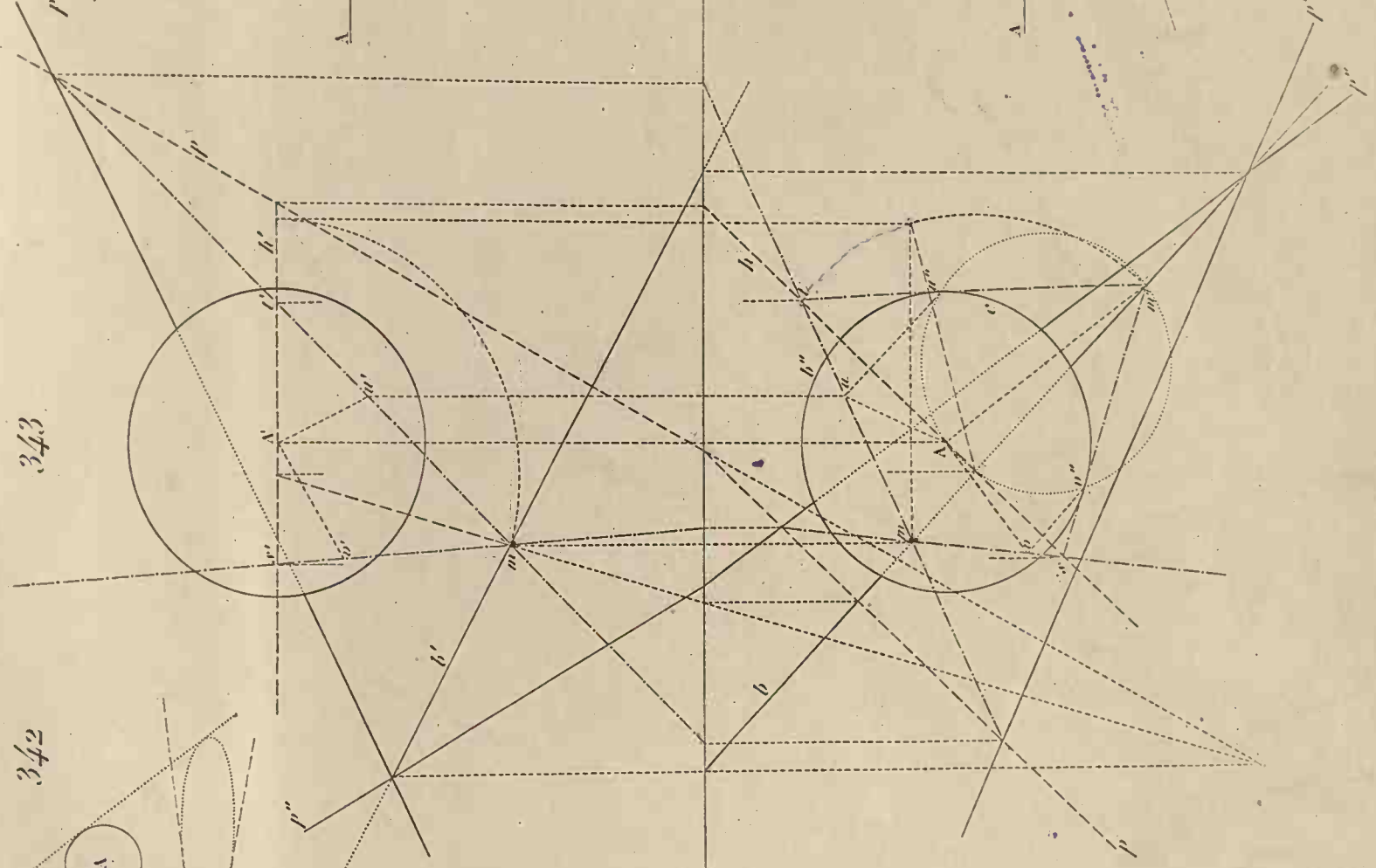

344

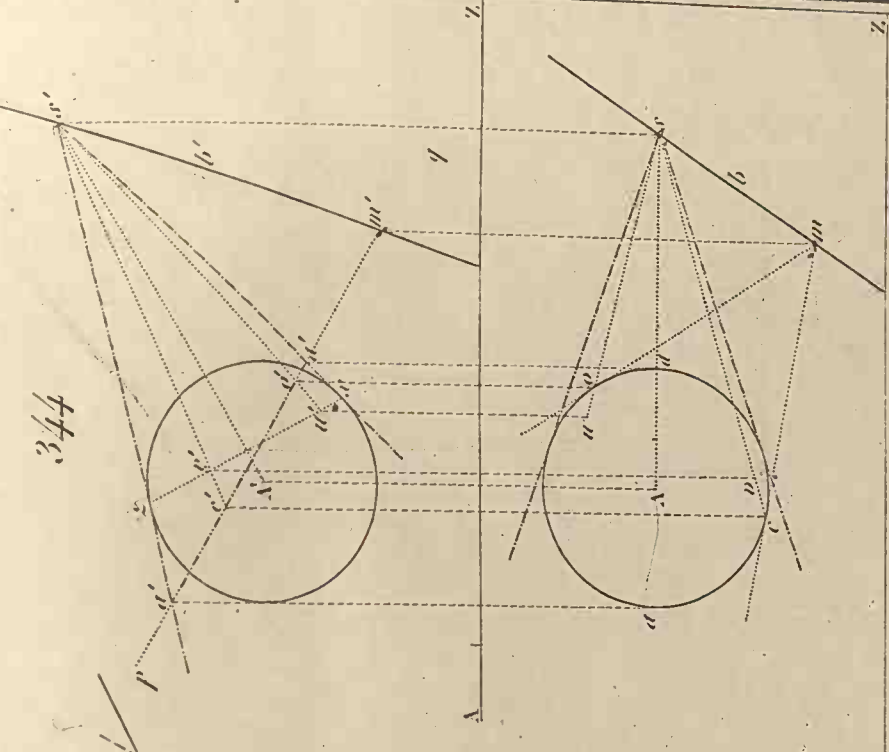

345

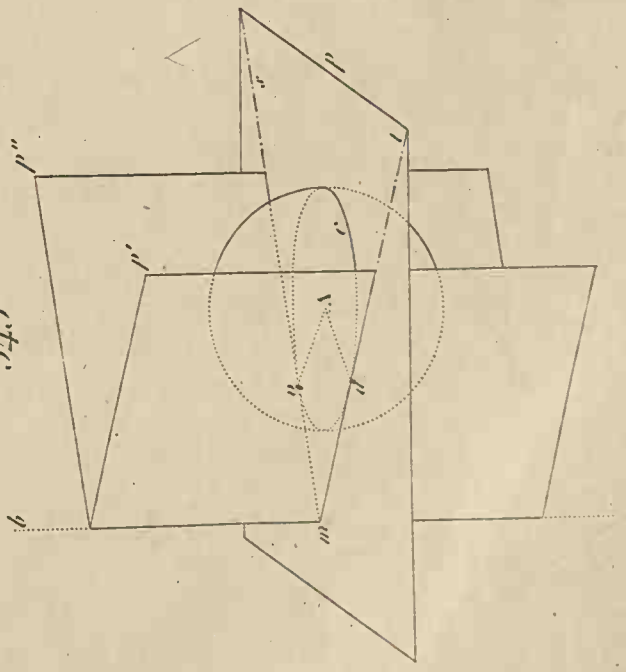

346

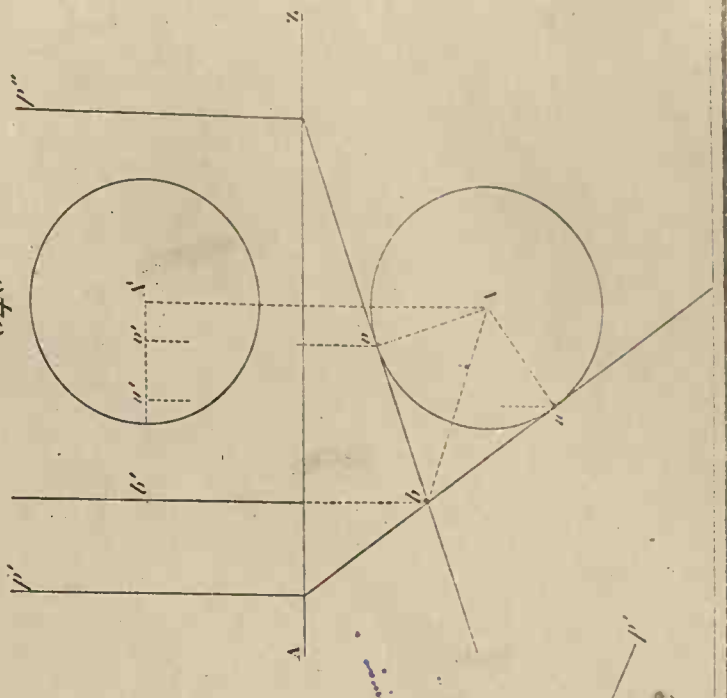

Plan tangent à la Sphere.

Geometrie descriptive.

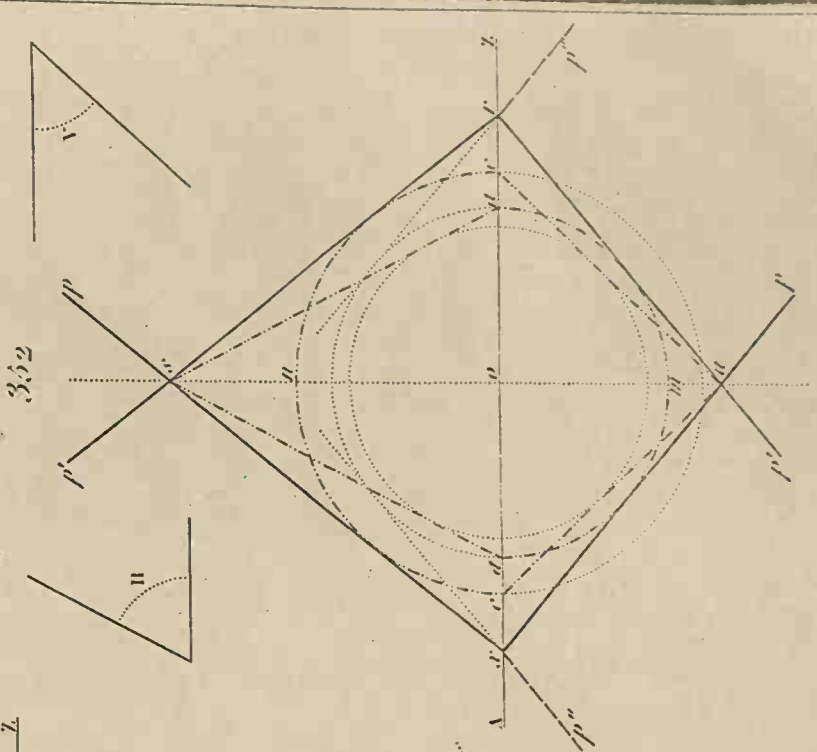
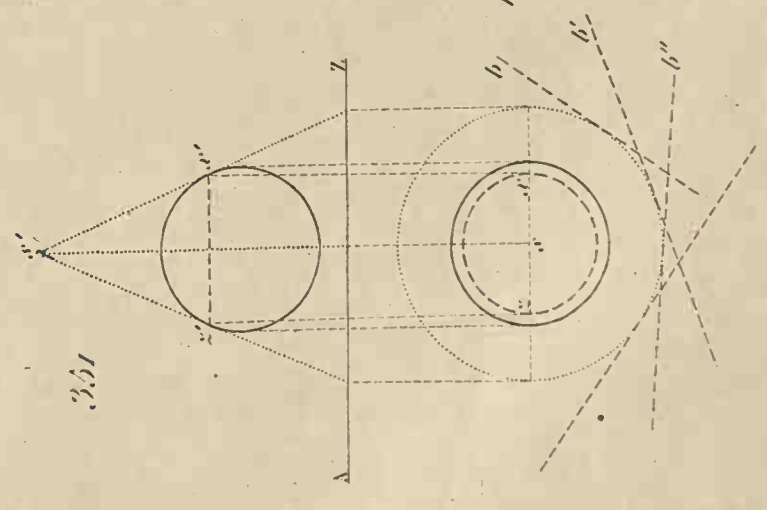
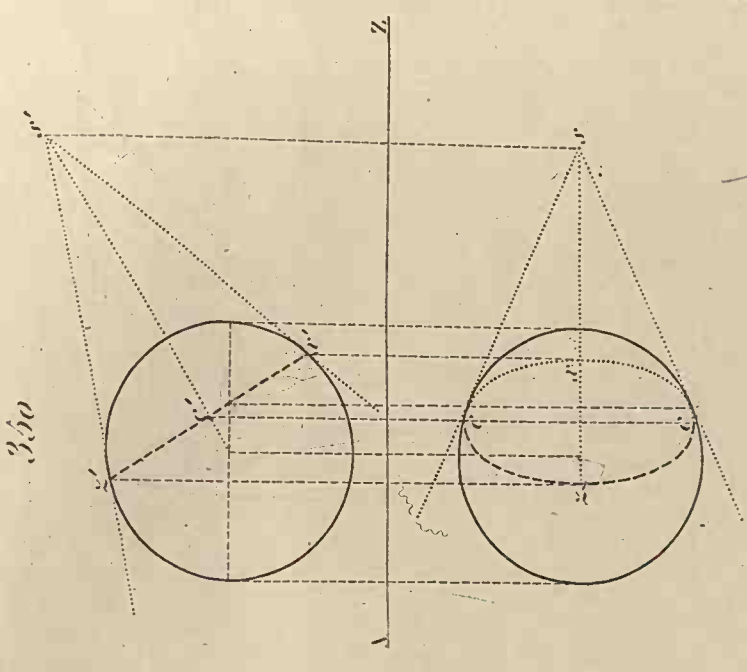
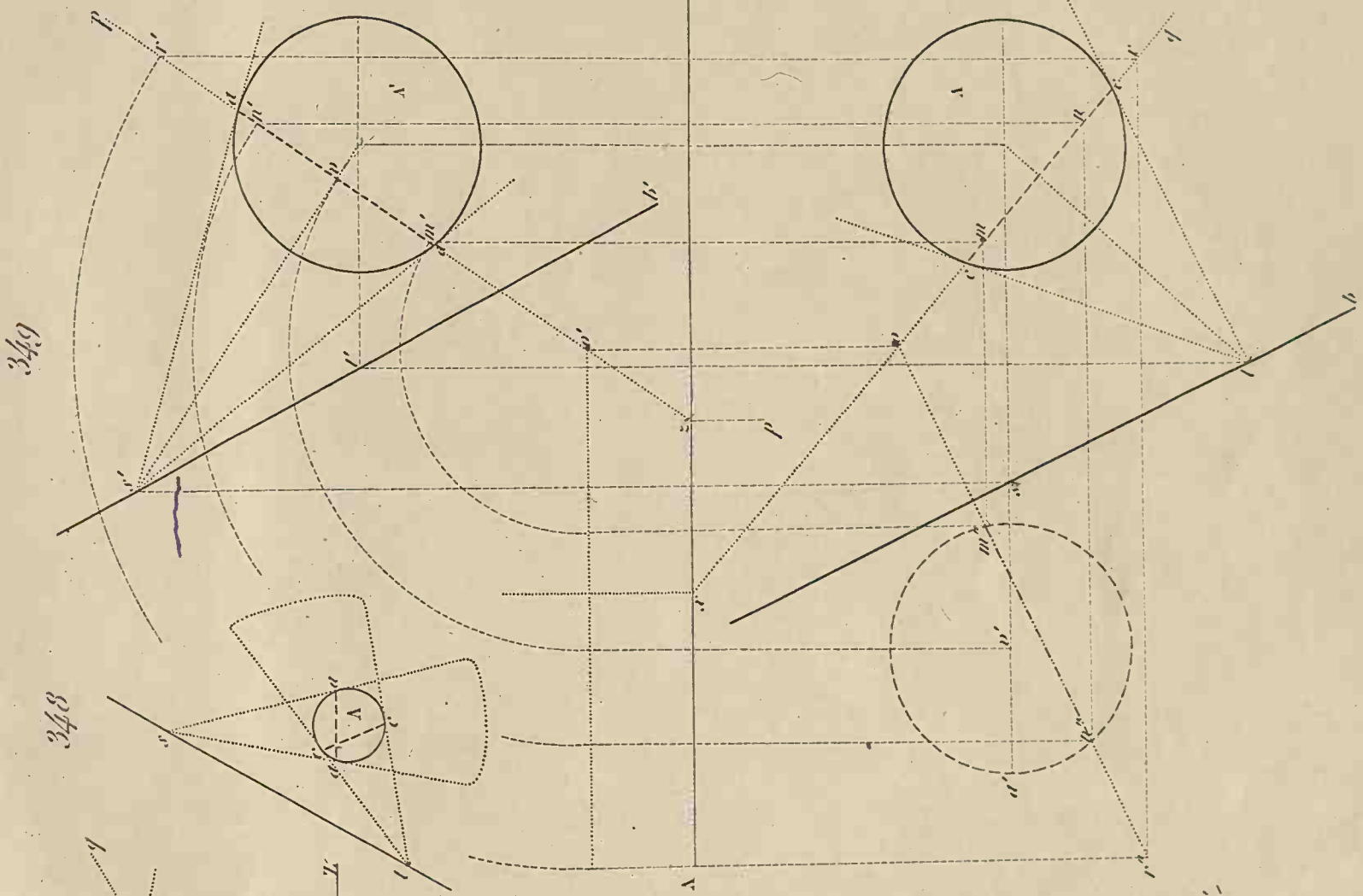
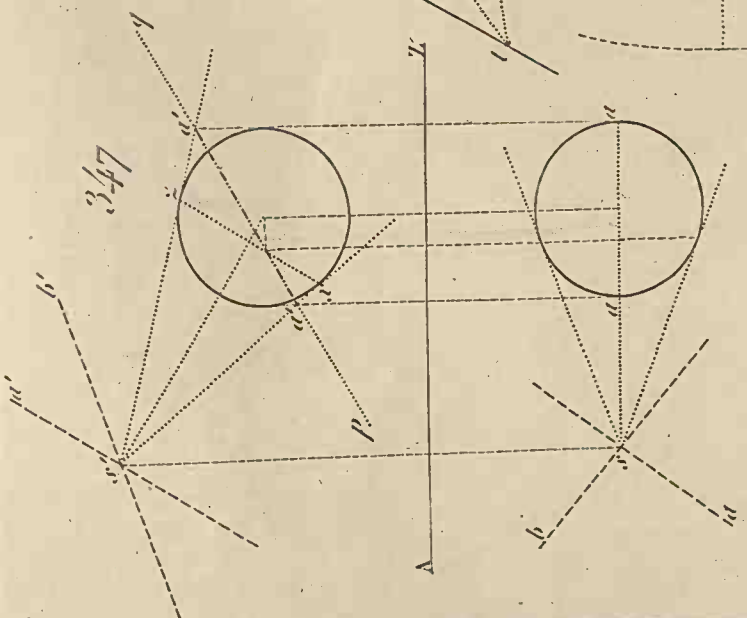

360

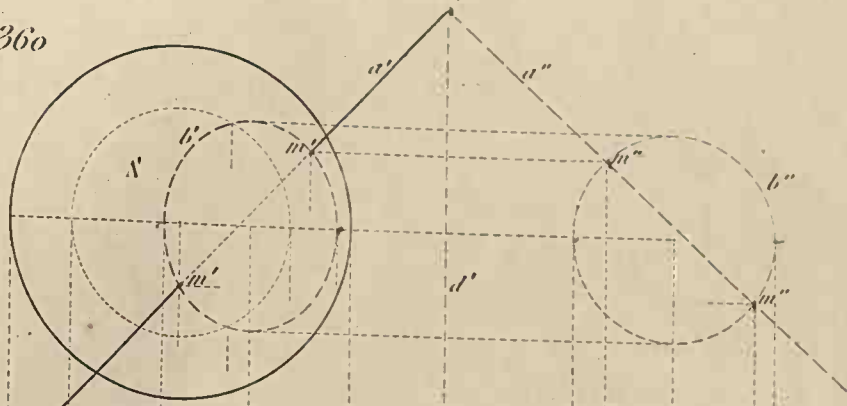

361

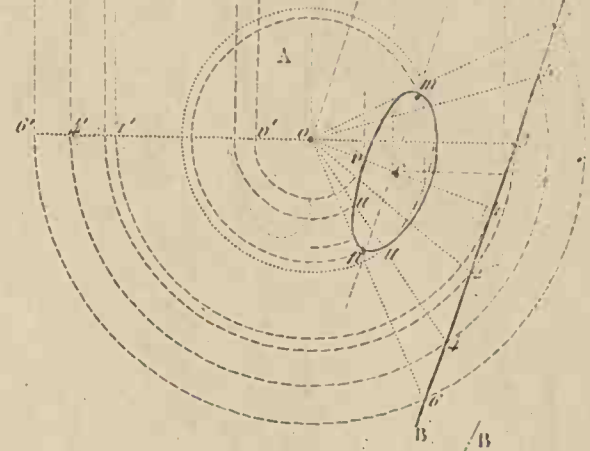
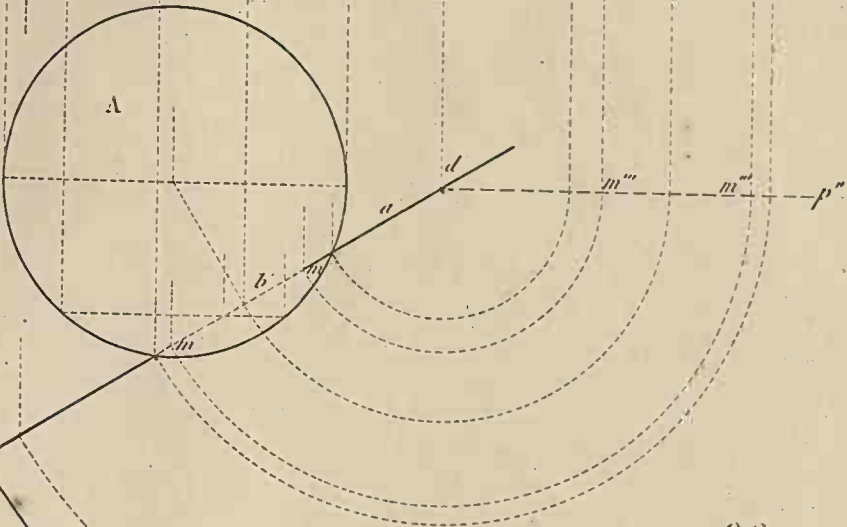
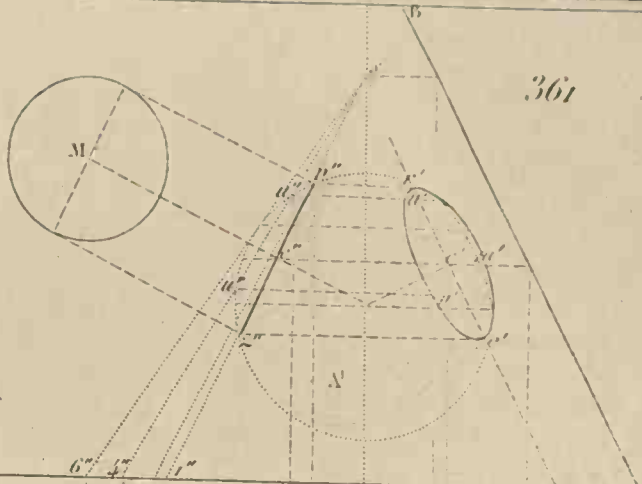

362

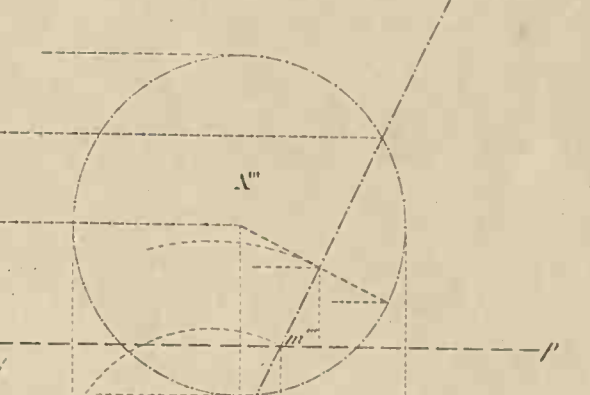
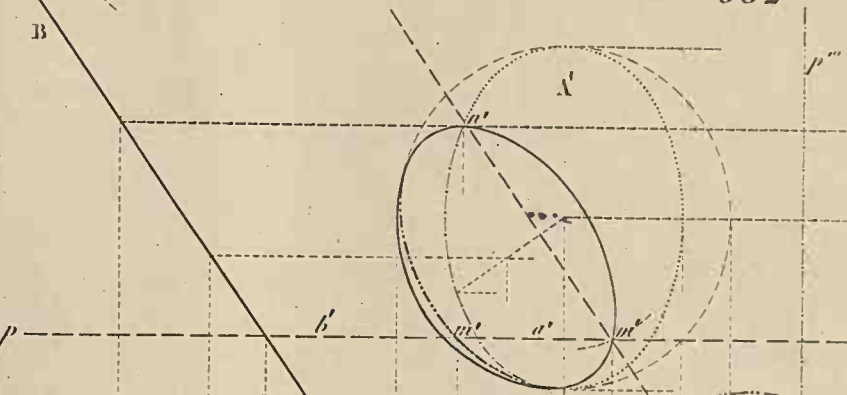

363

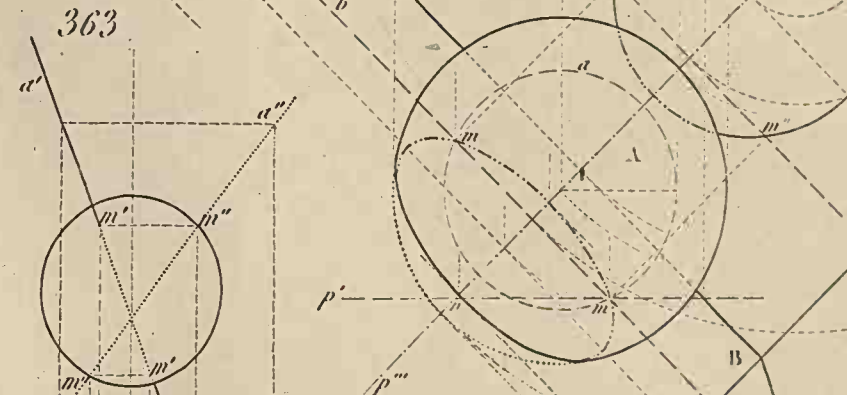

364

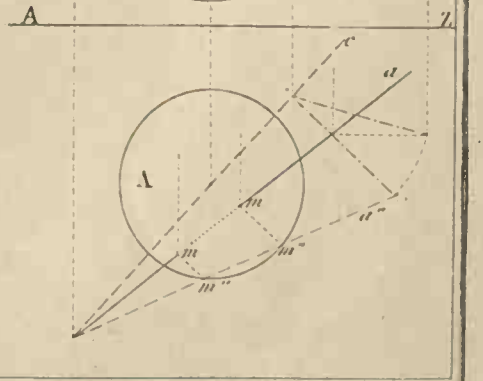
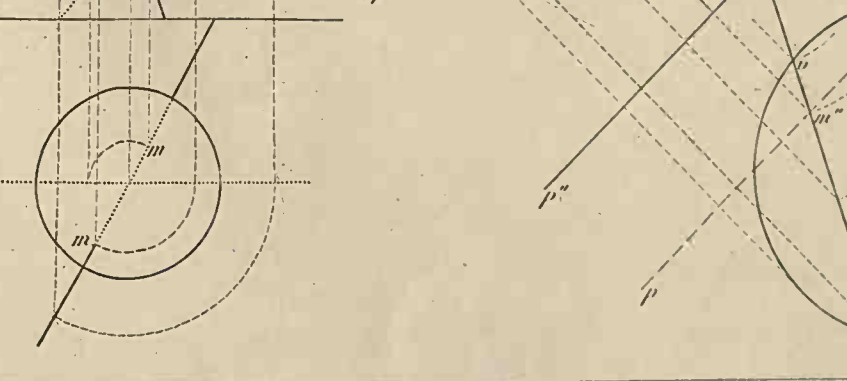
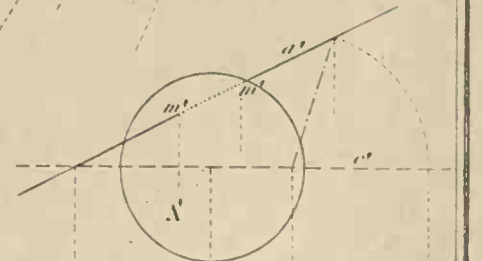

365

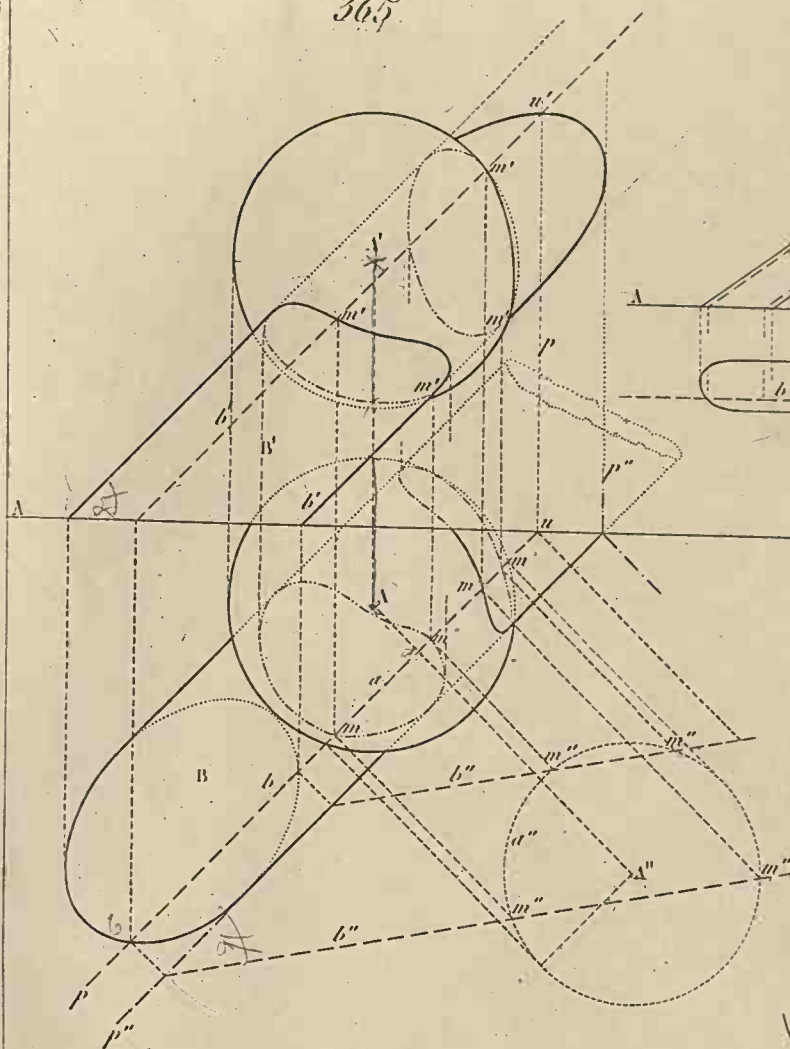

366

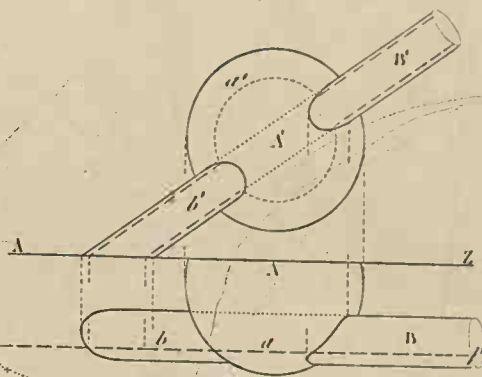

367

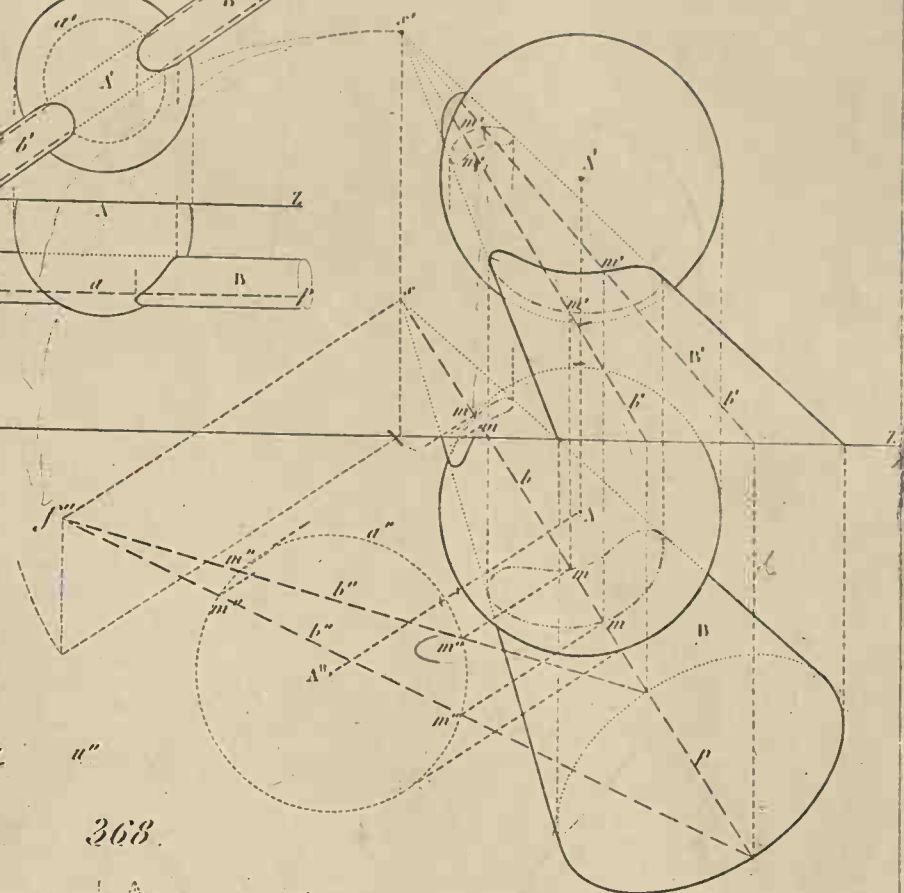

368

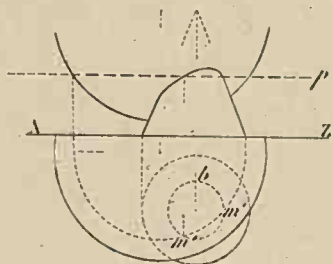

369

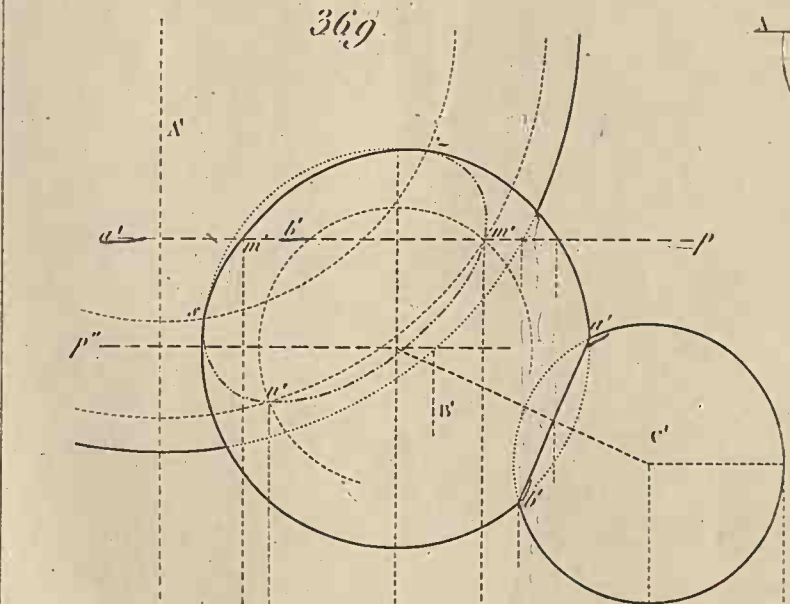

370

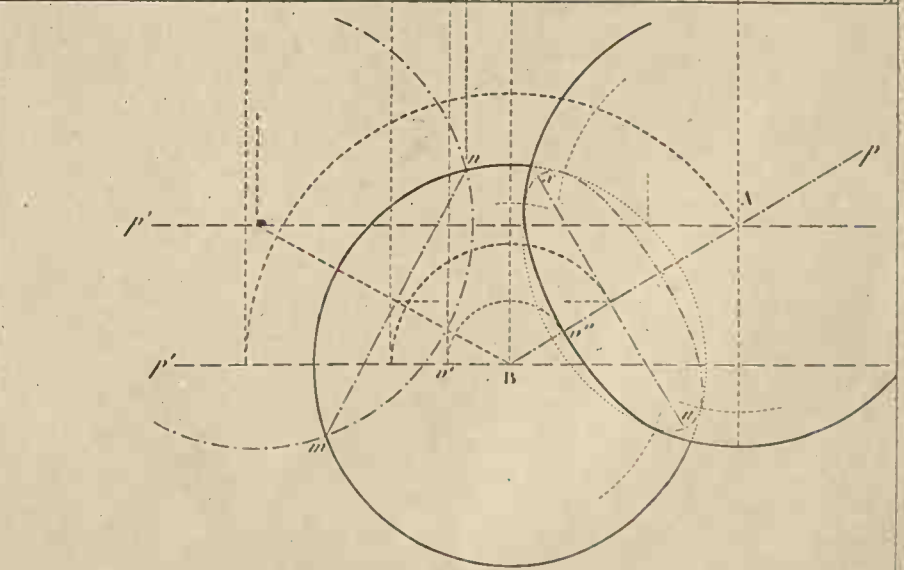
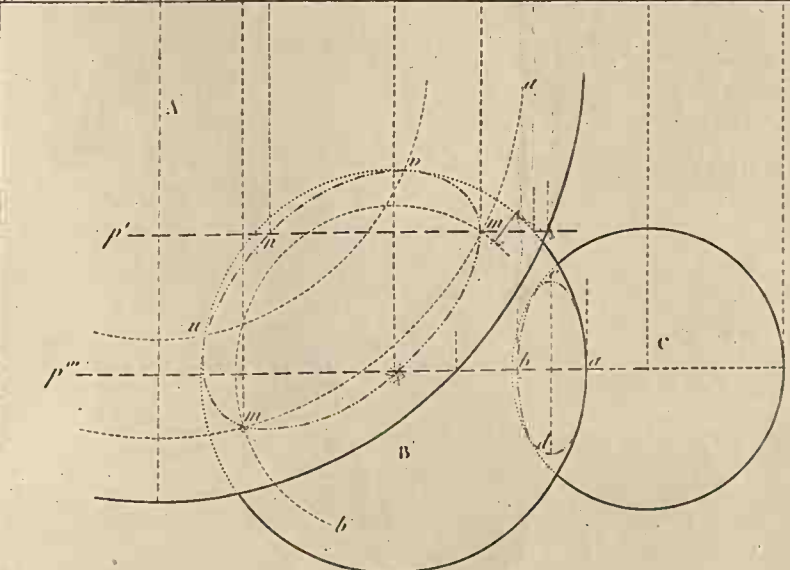
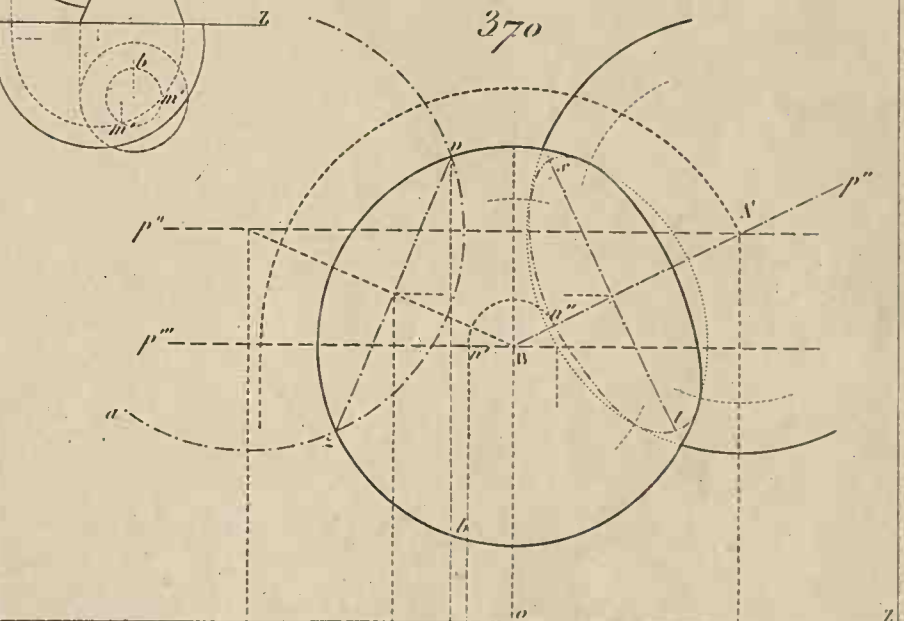

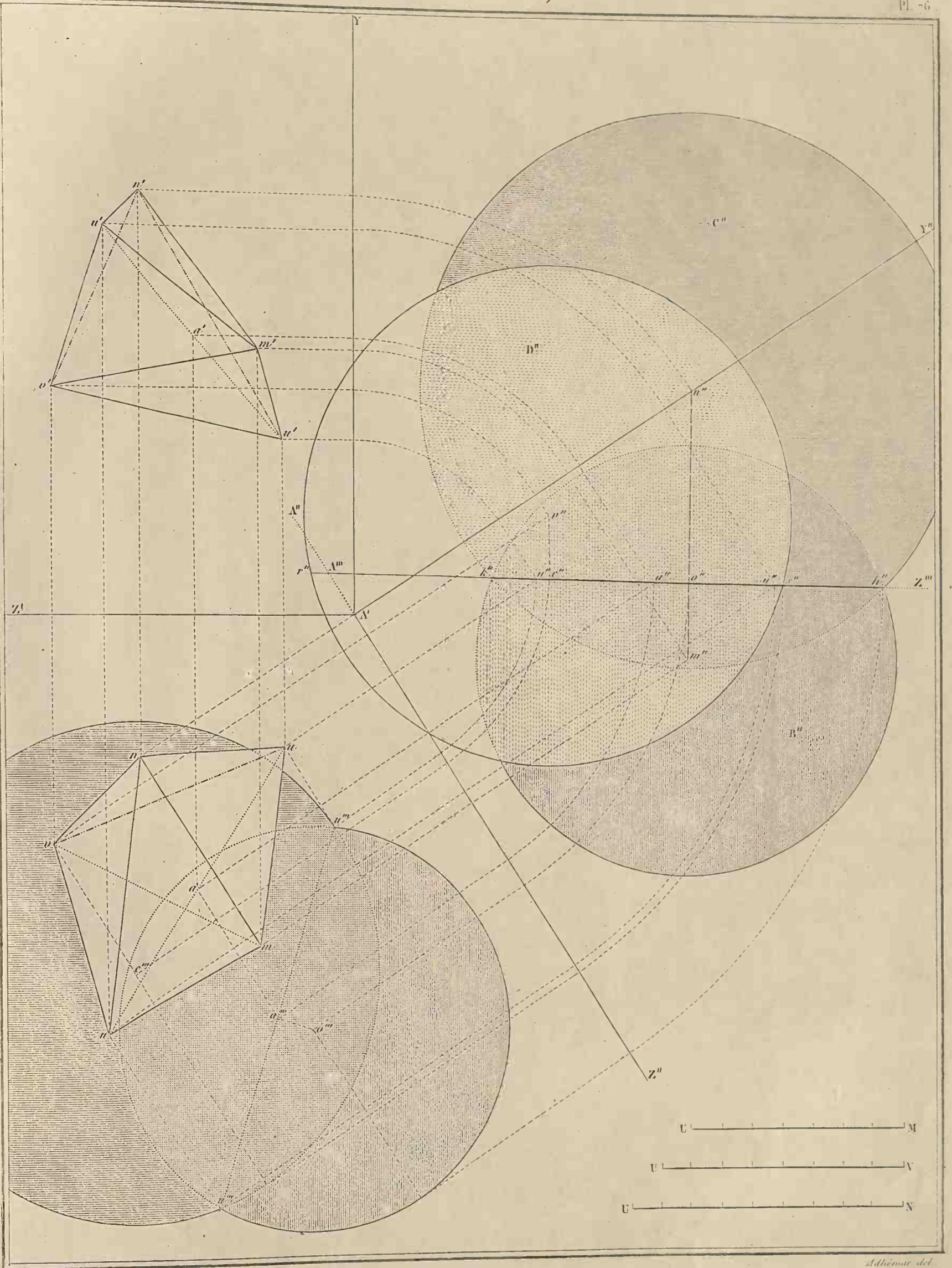

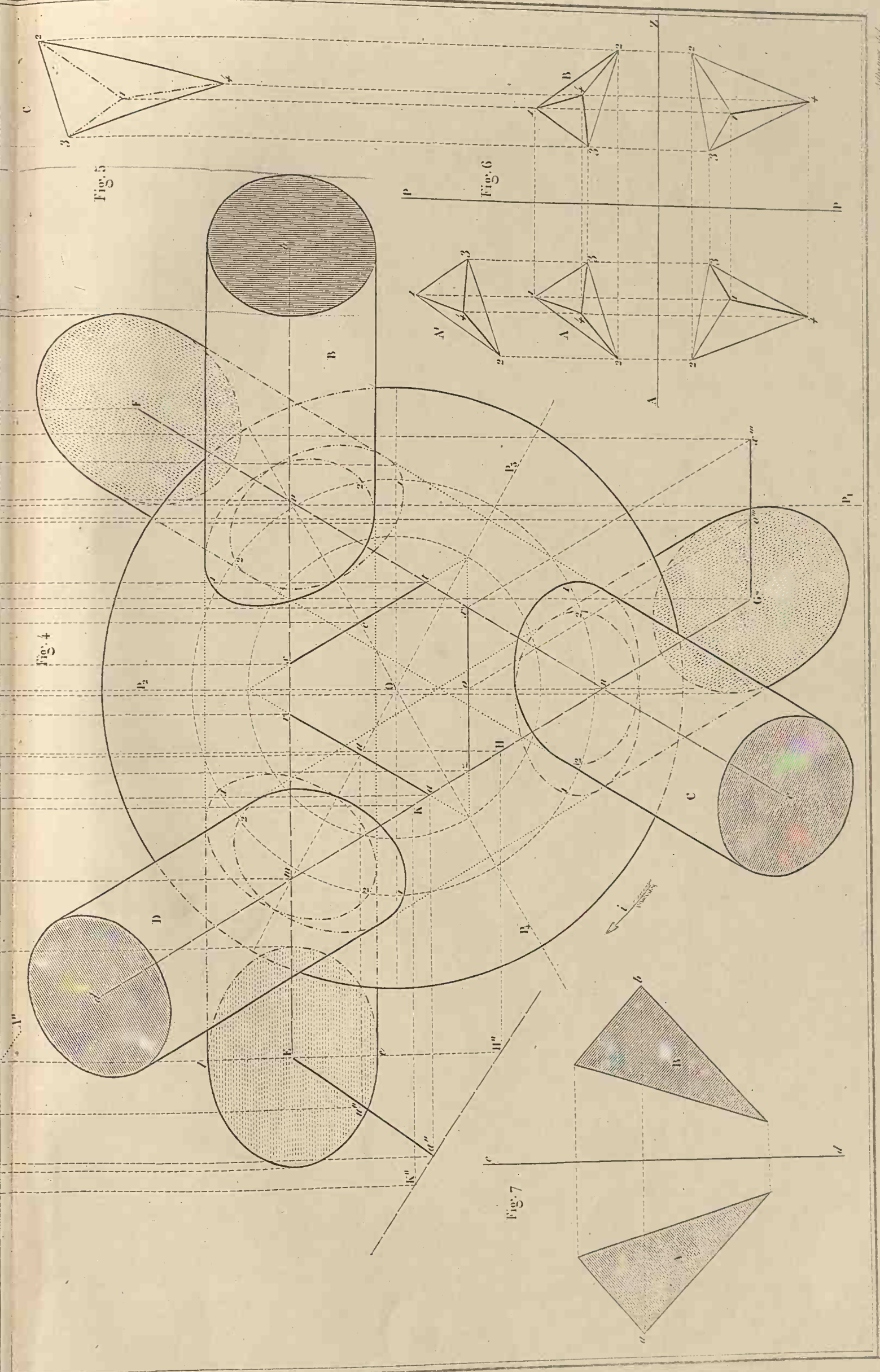
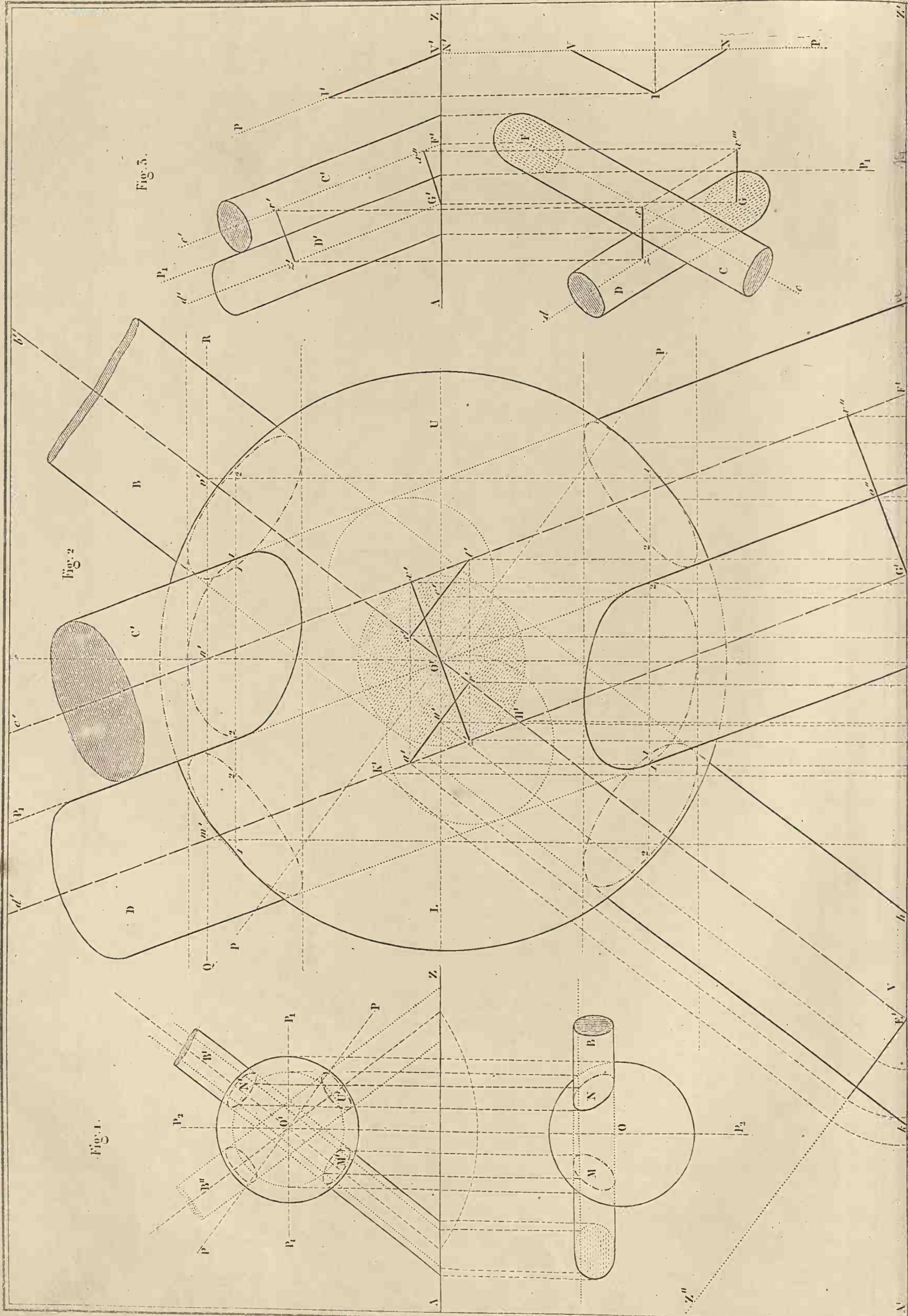

Sphères, Cylindres et Cônes.

Géométrie descriptive.

Pl. 78.

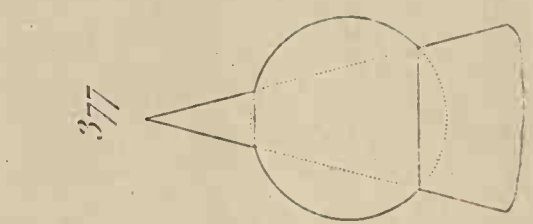
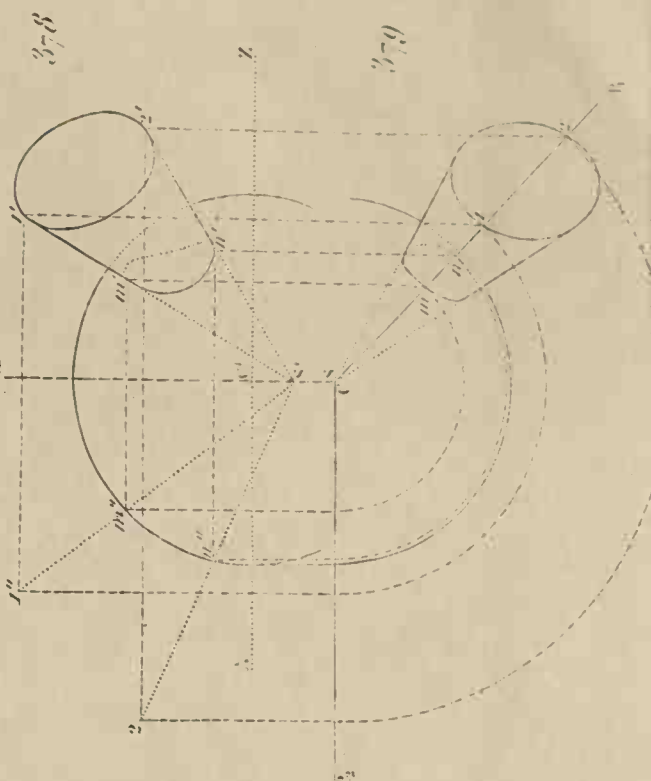
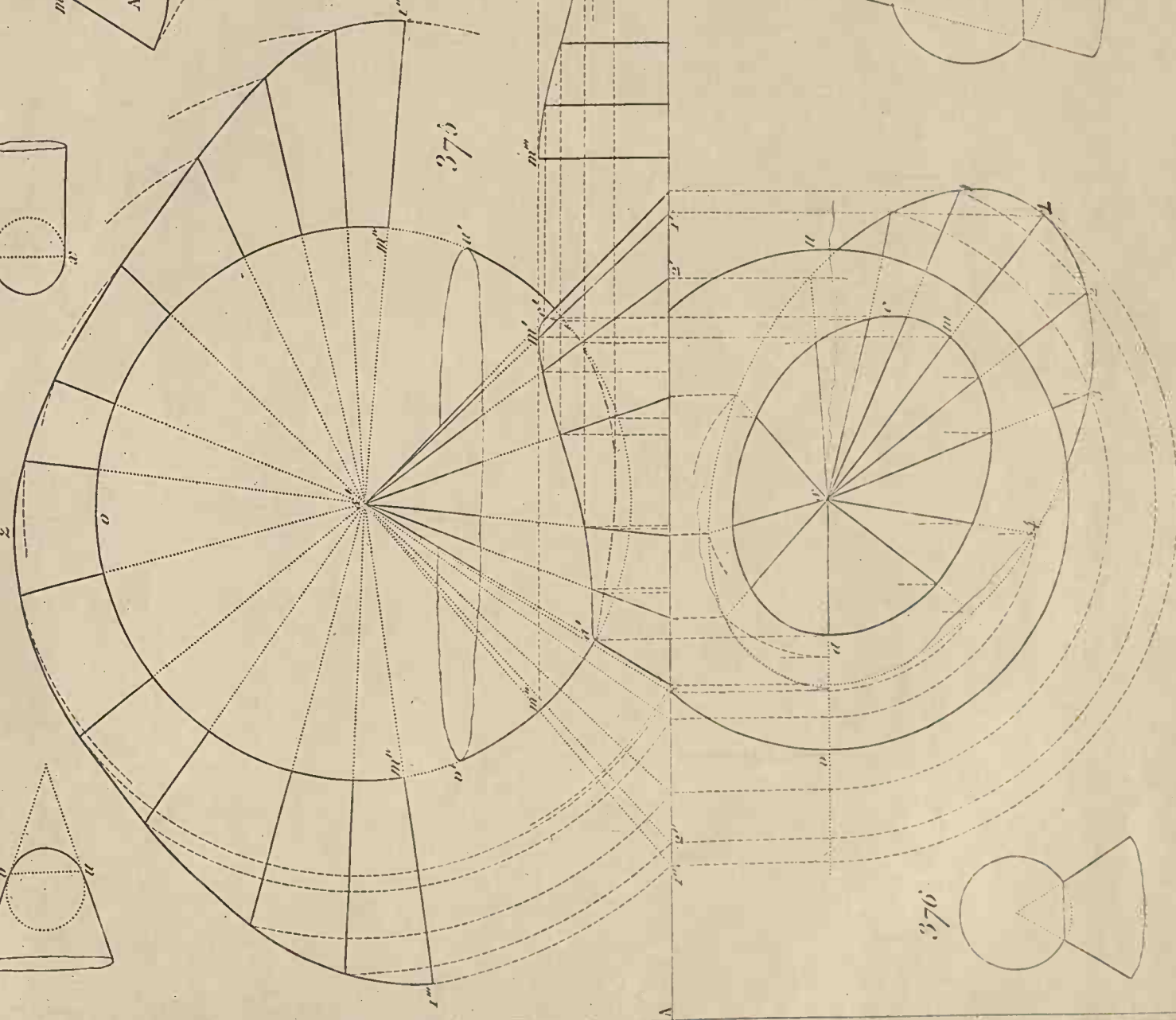
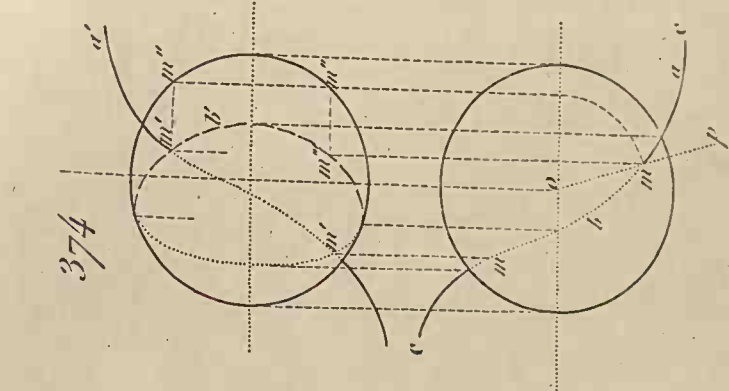
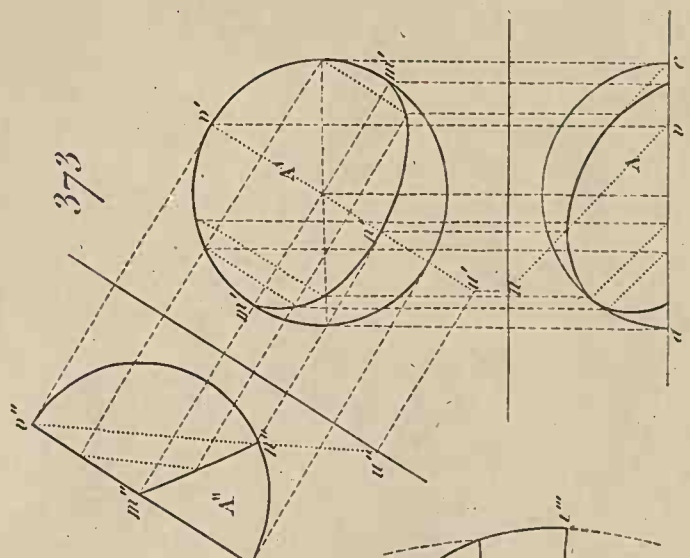
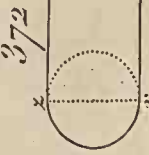
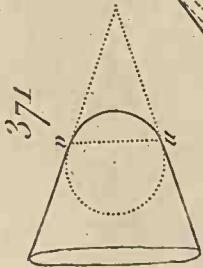

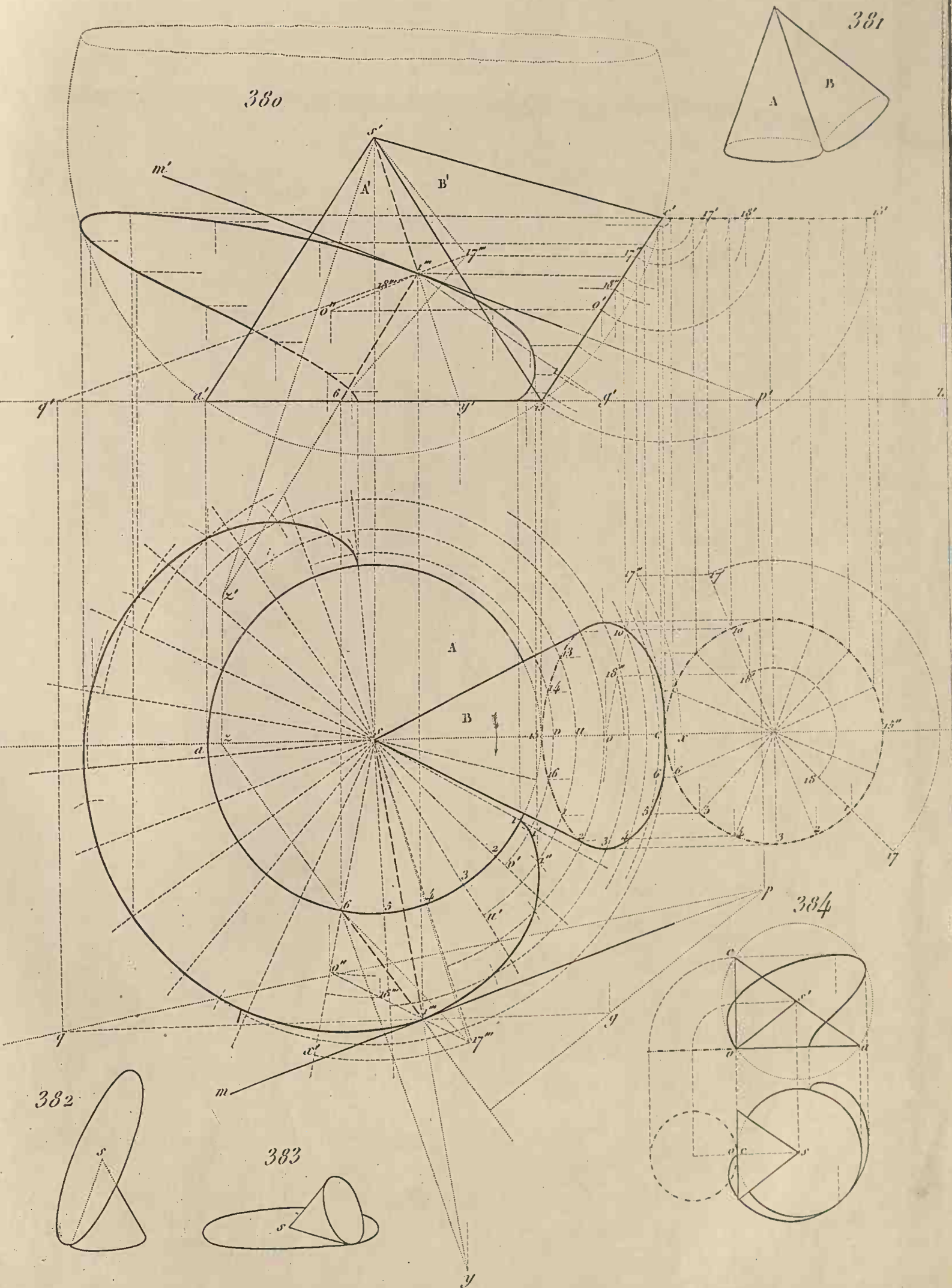

385

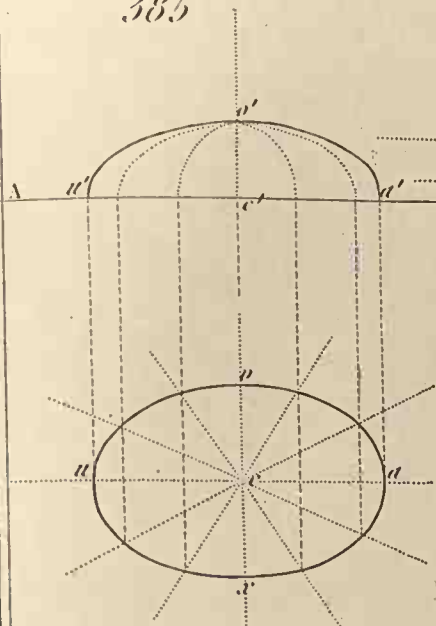

386

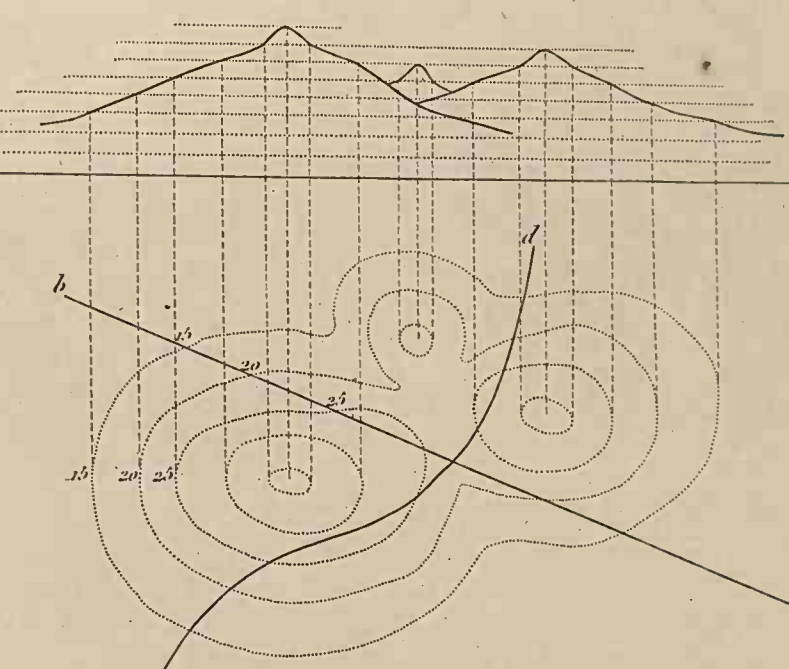

387

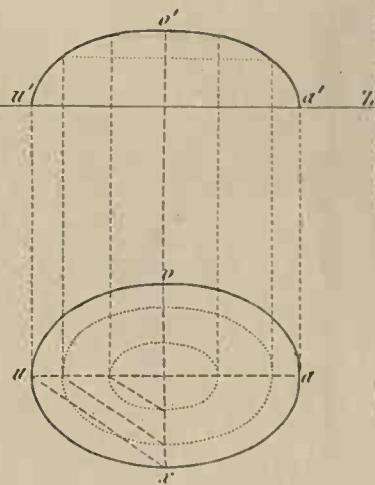

388

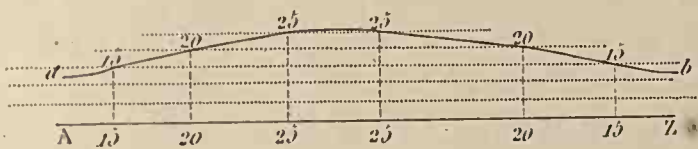

389

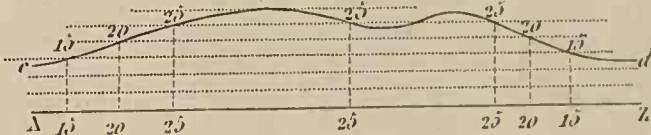

390

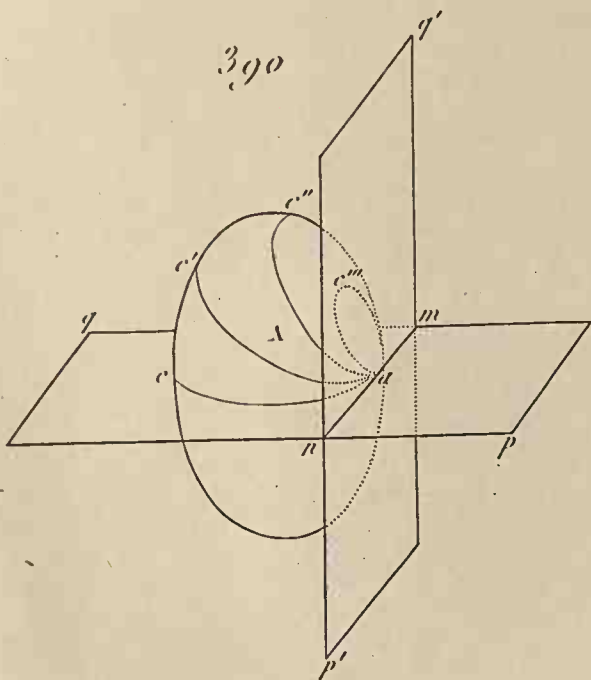

391

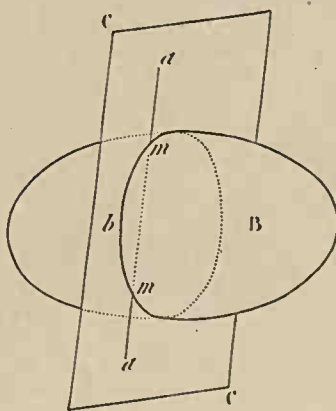

392

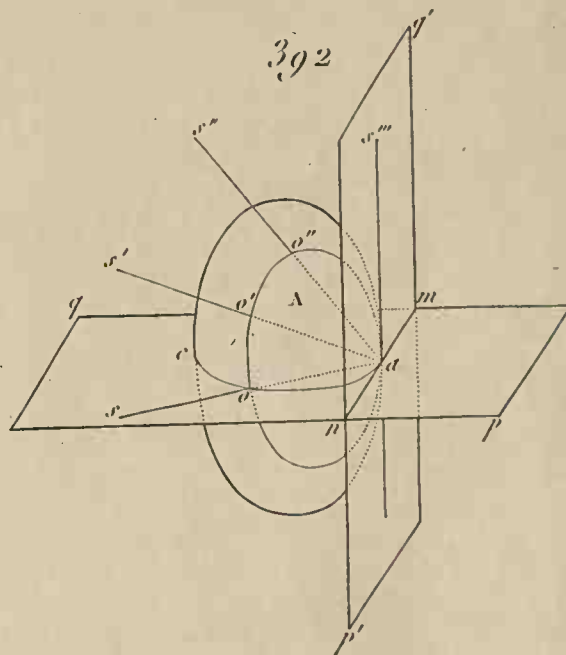

394

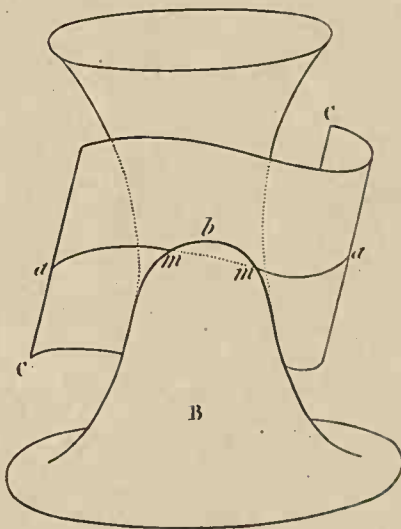

393

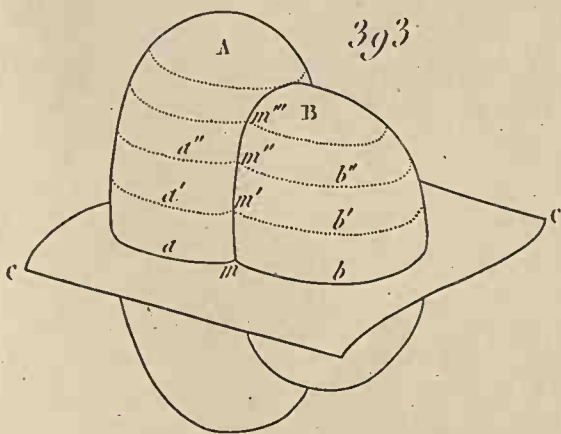

395

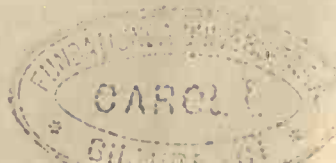
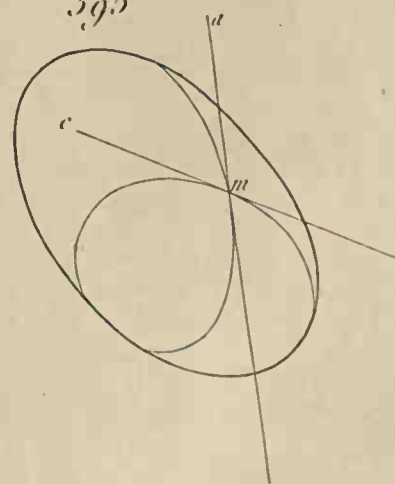

396

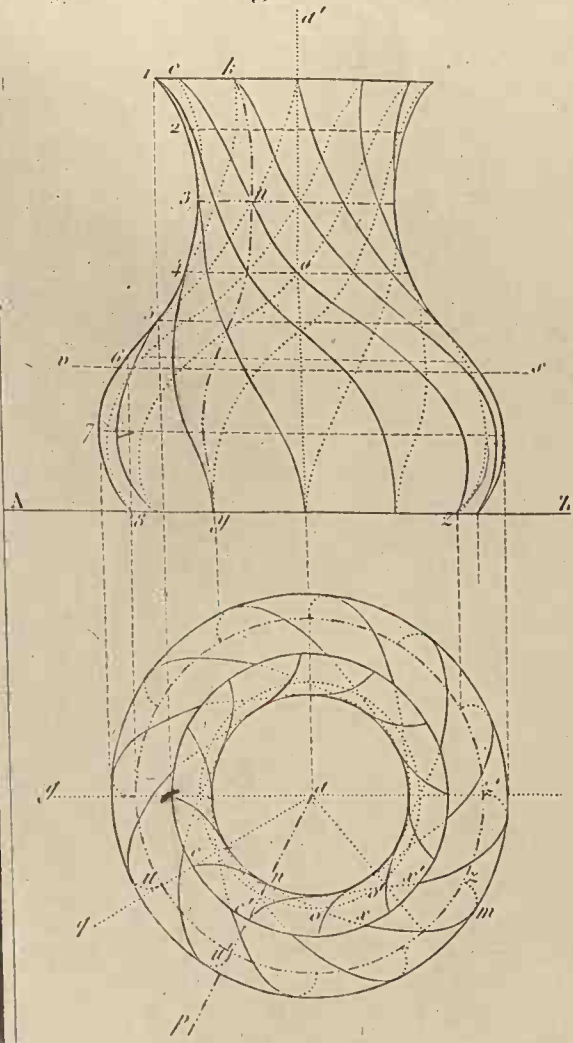

397

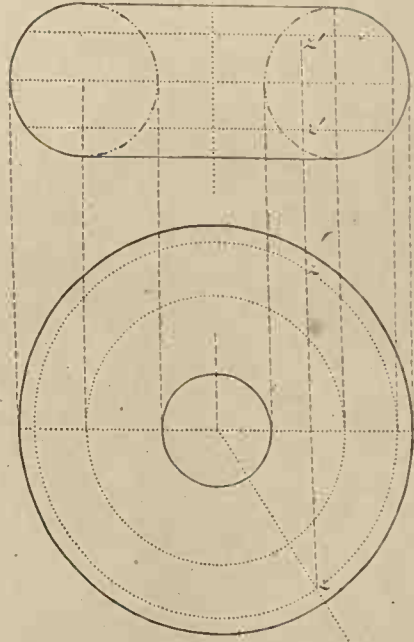

398

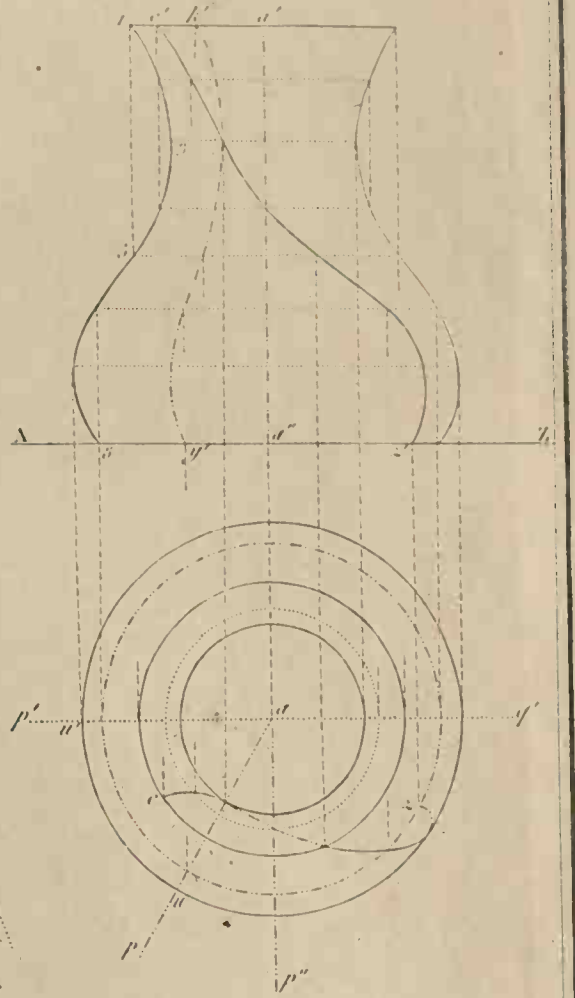

399

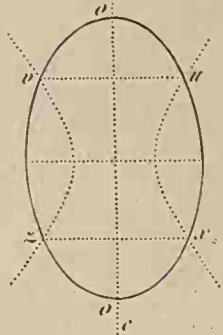

400

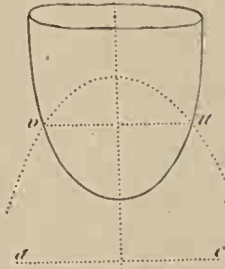

401

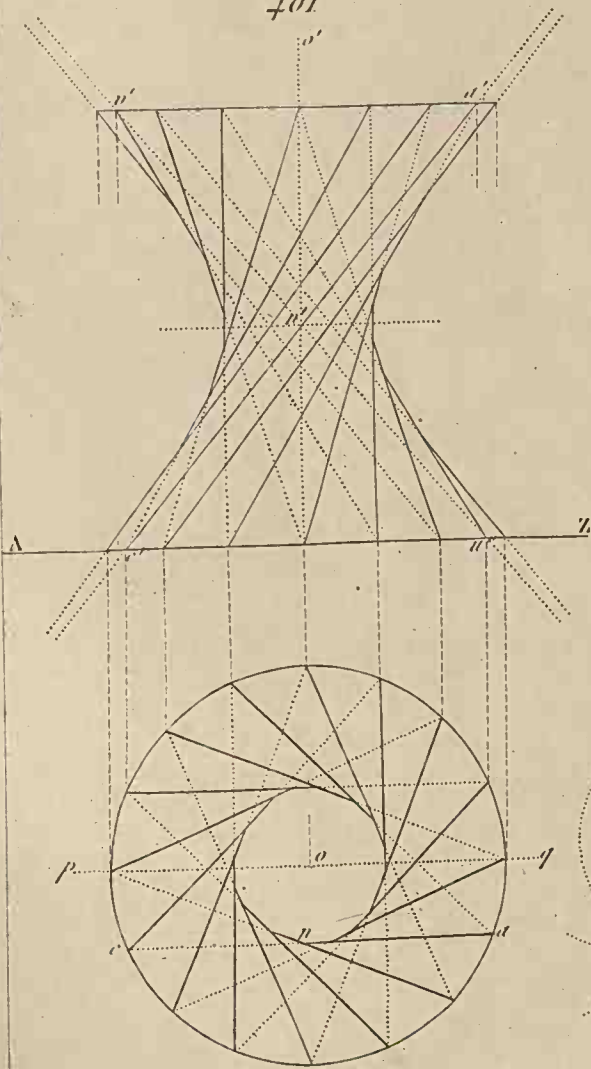

402

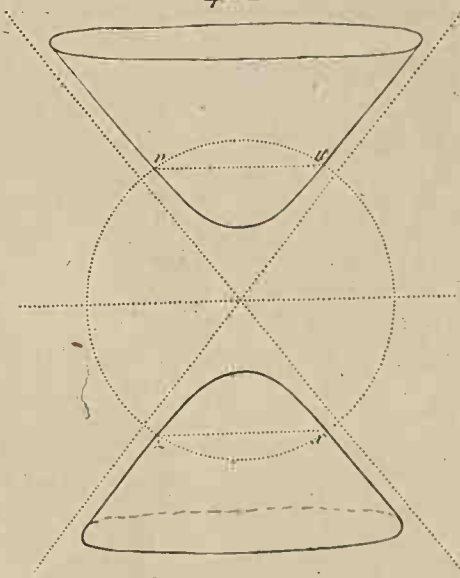

403

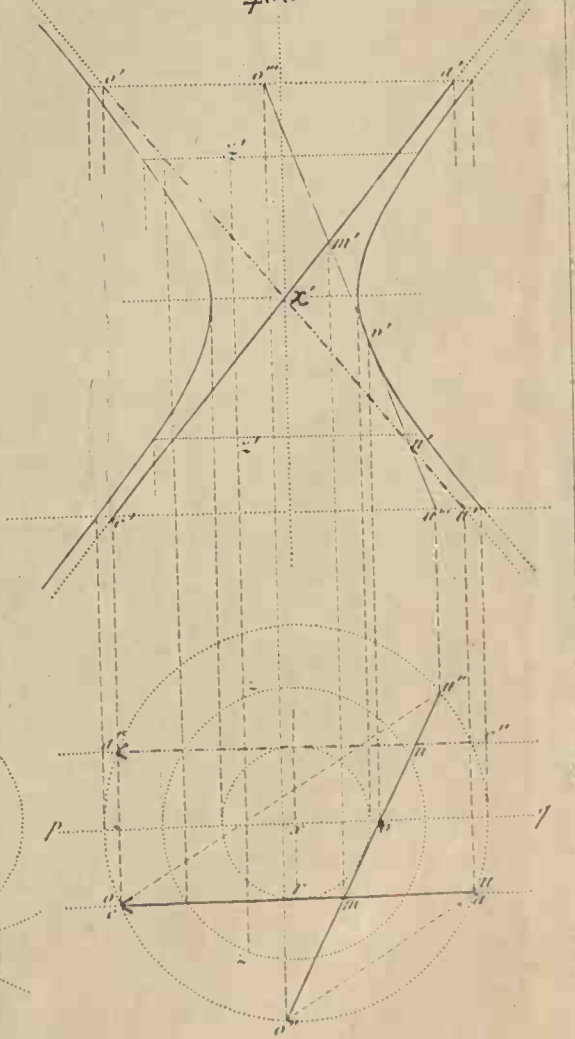

404

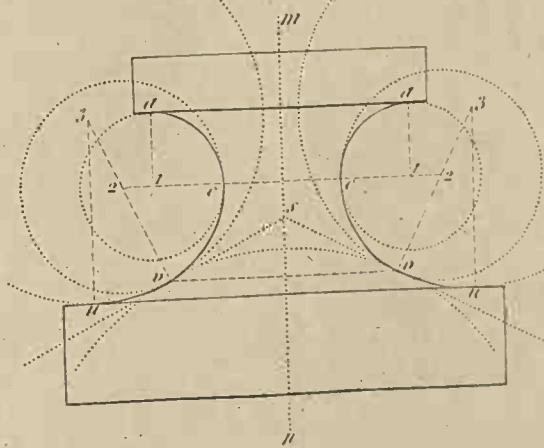

405

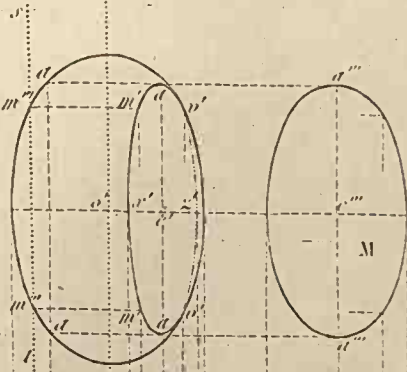

406

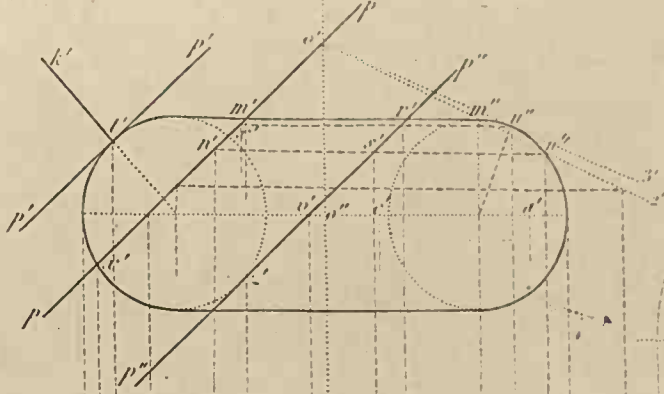

407

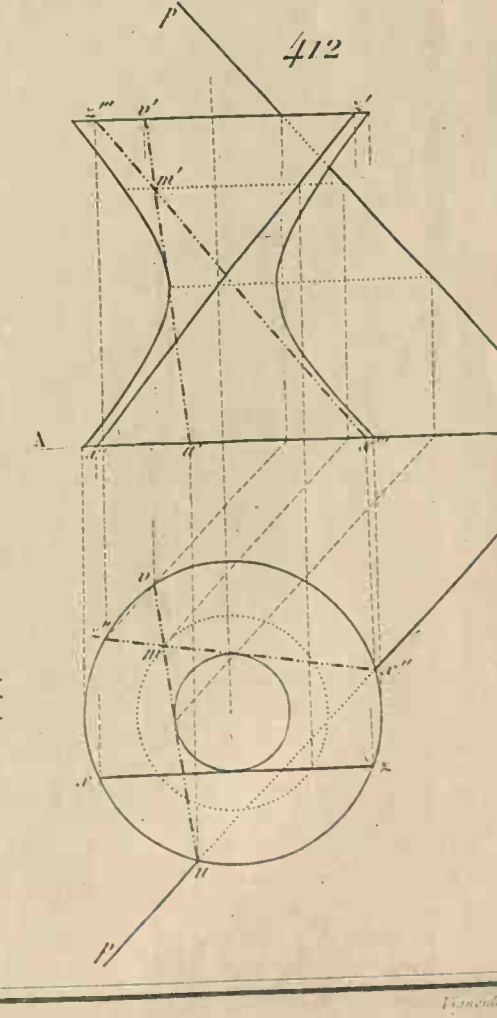
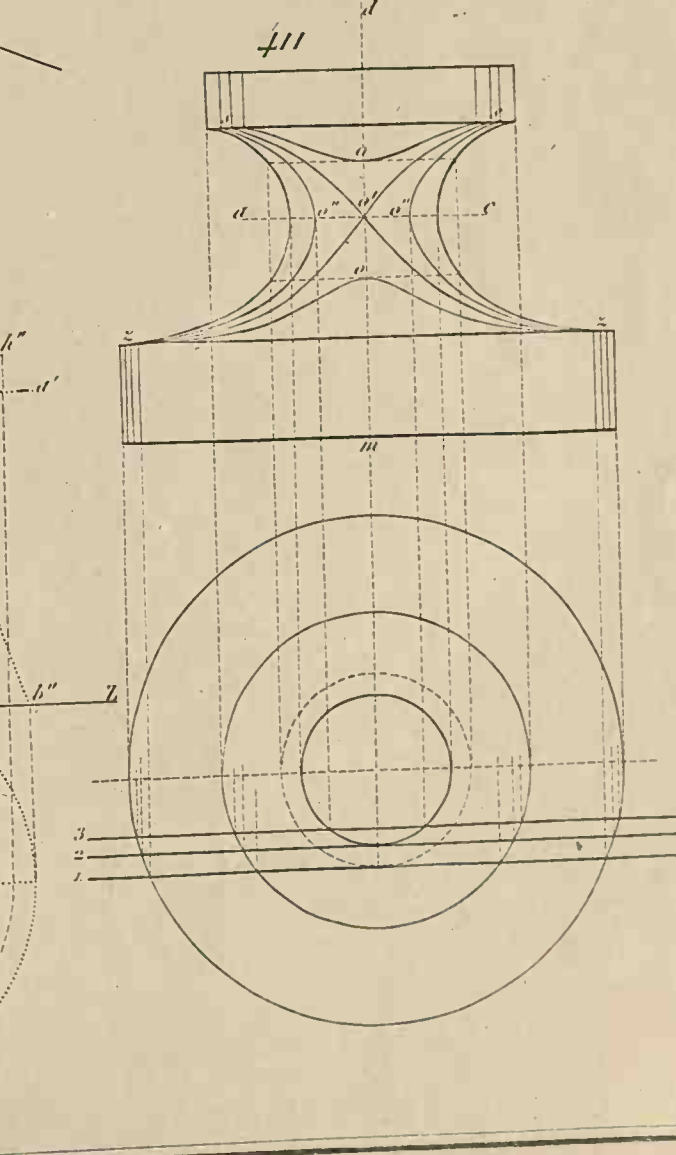
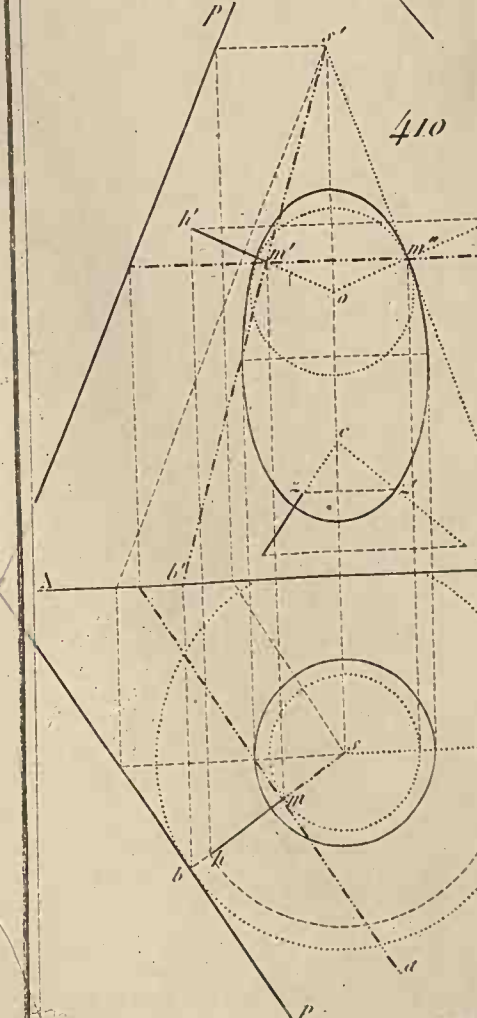
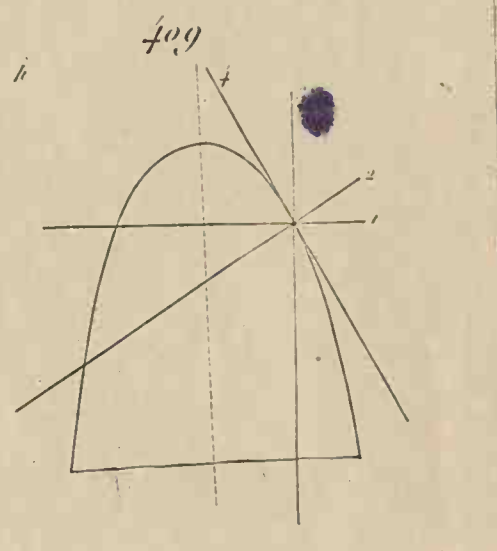
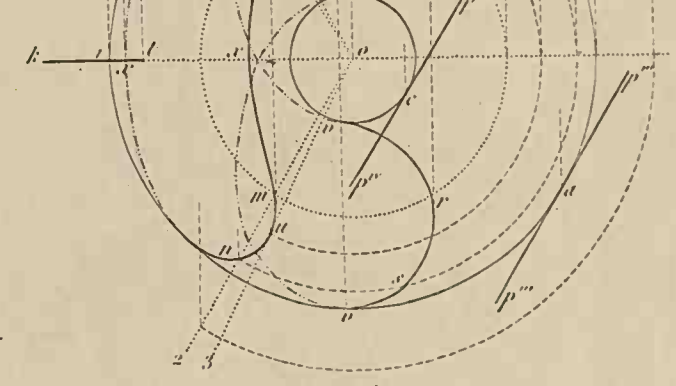
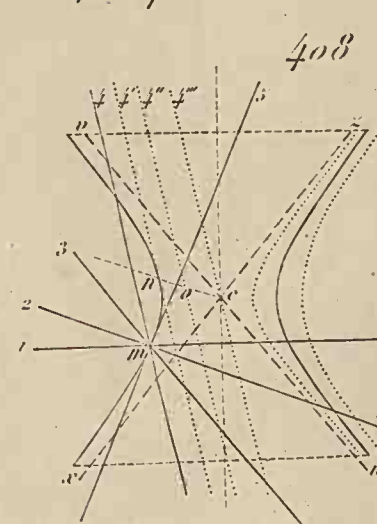
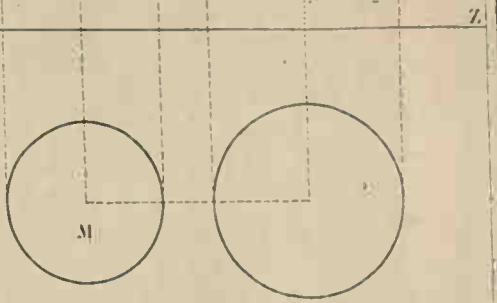
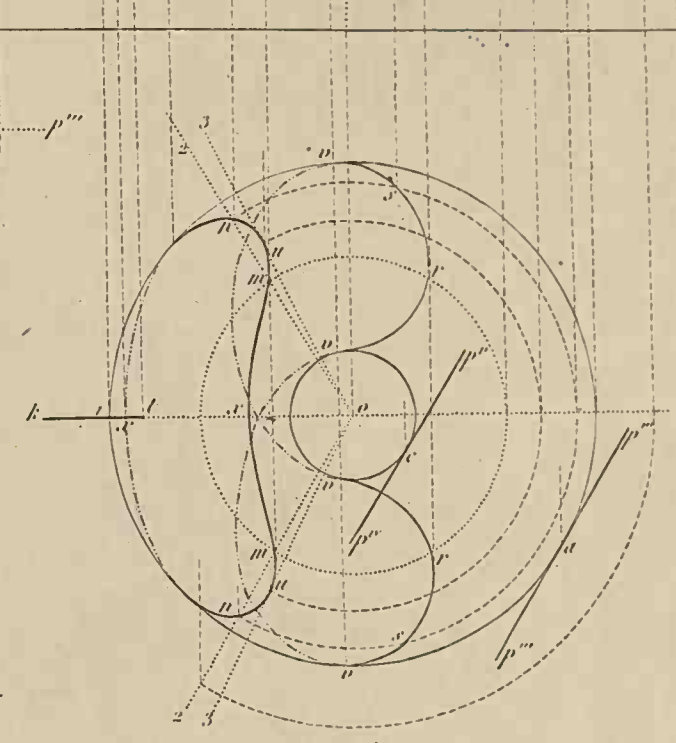
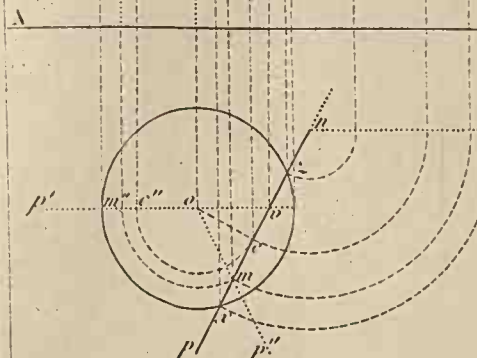
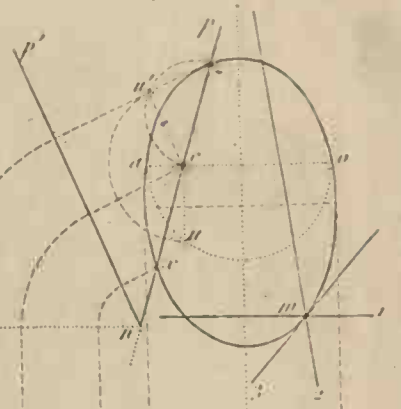

Geometrie descriptive.

413

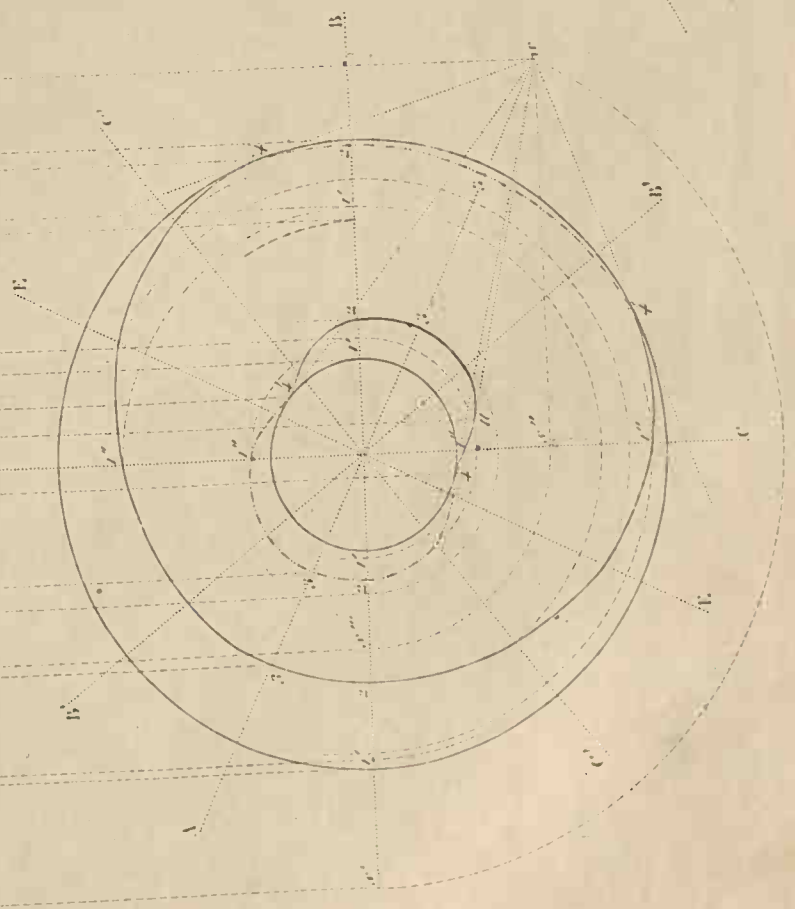
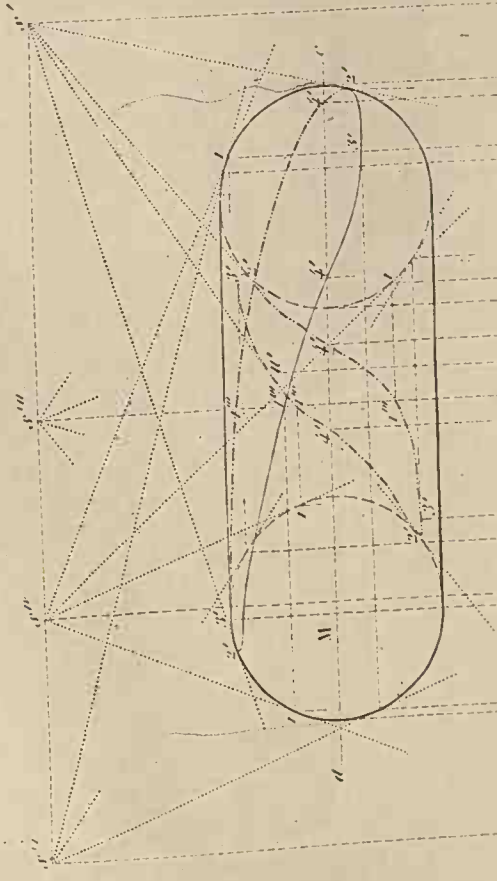

414

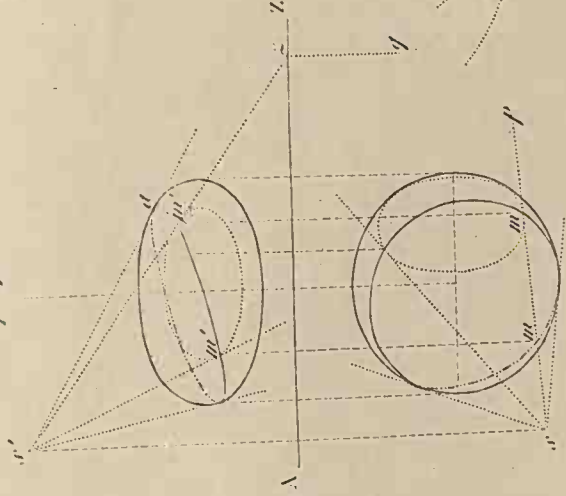

416

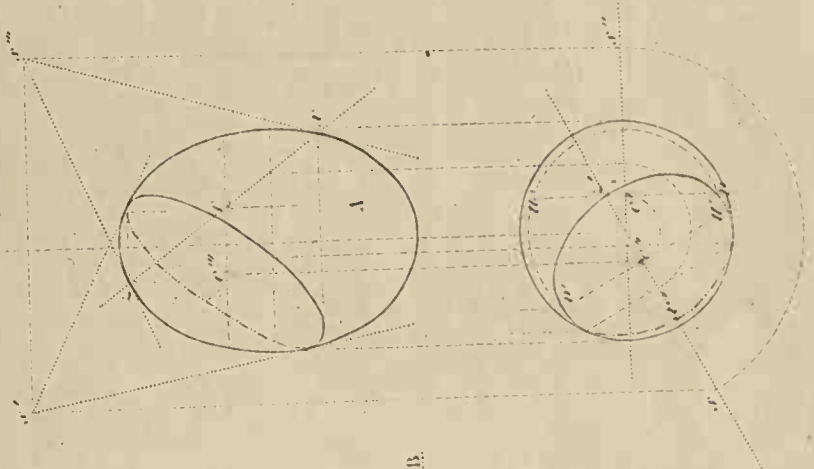

415

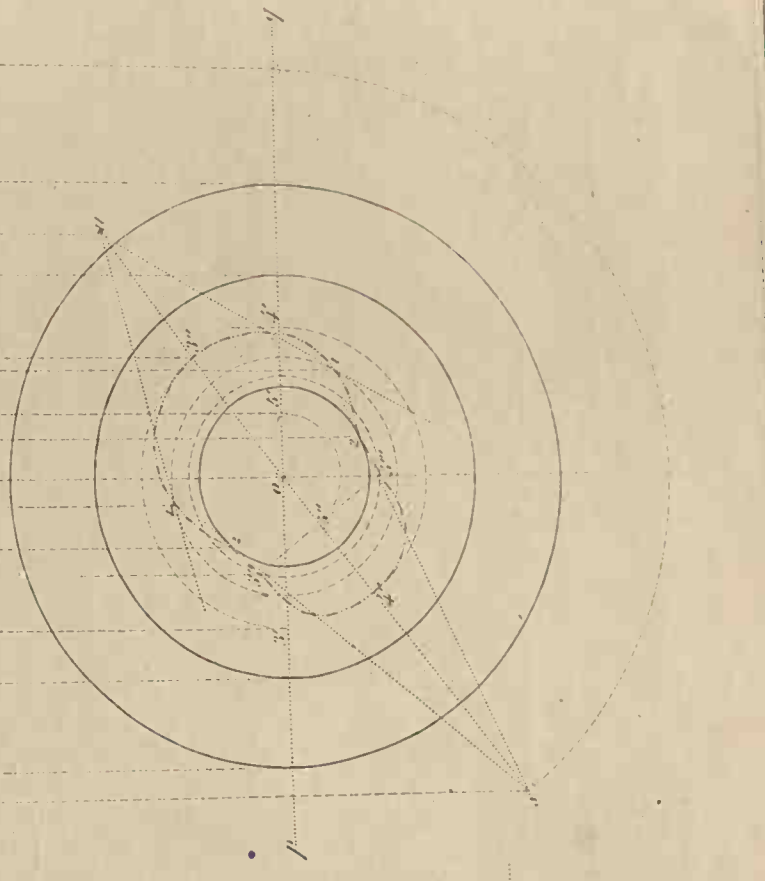
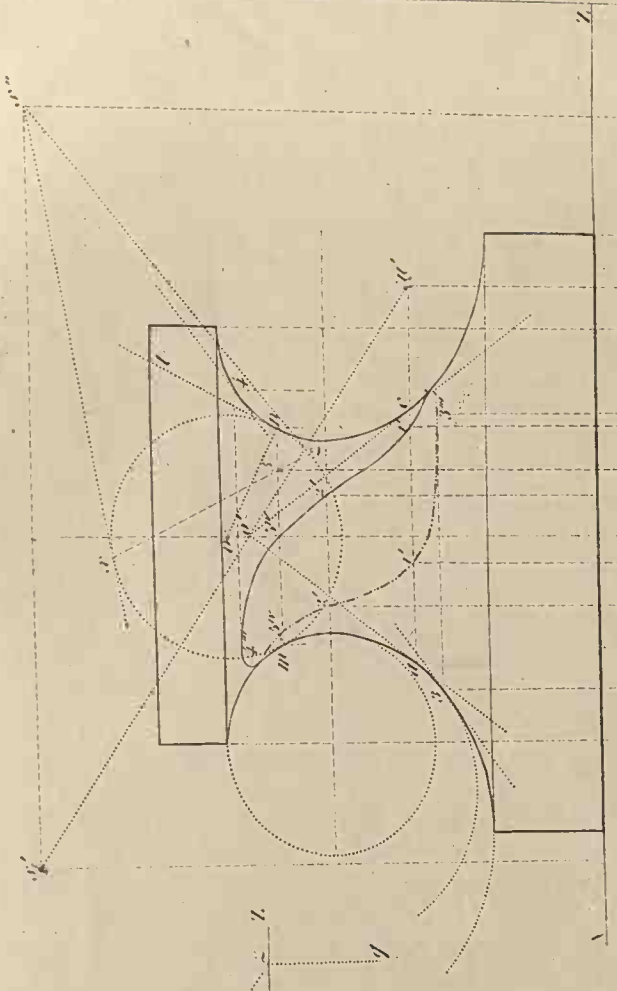

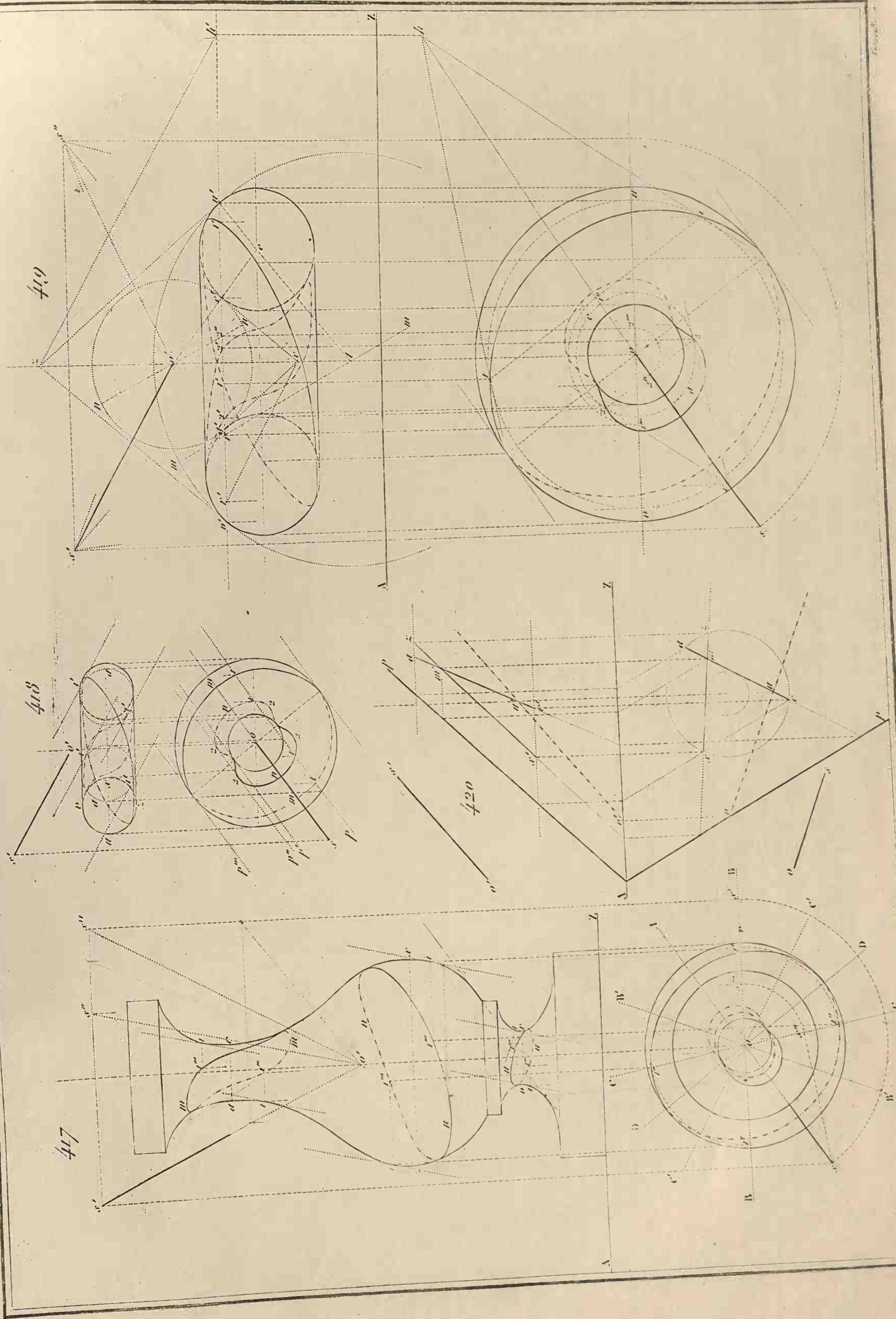

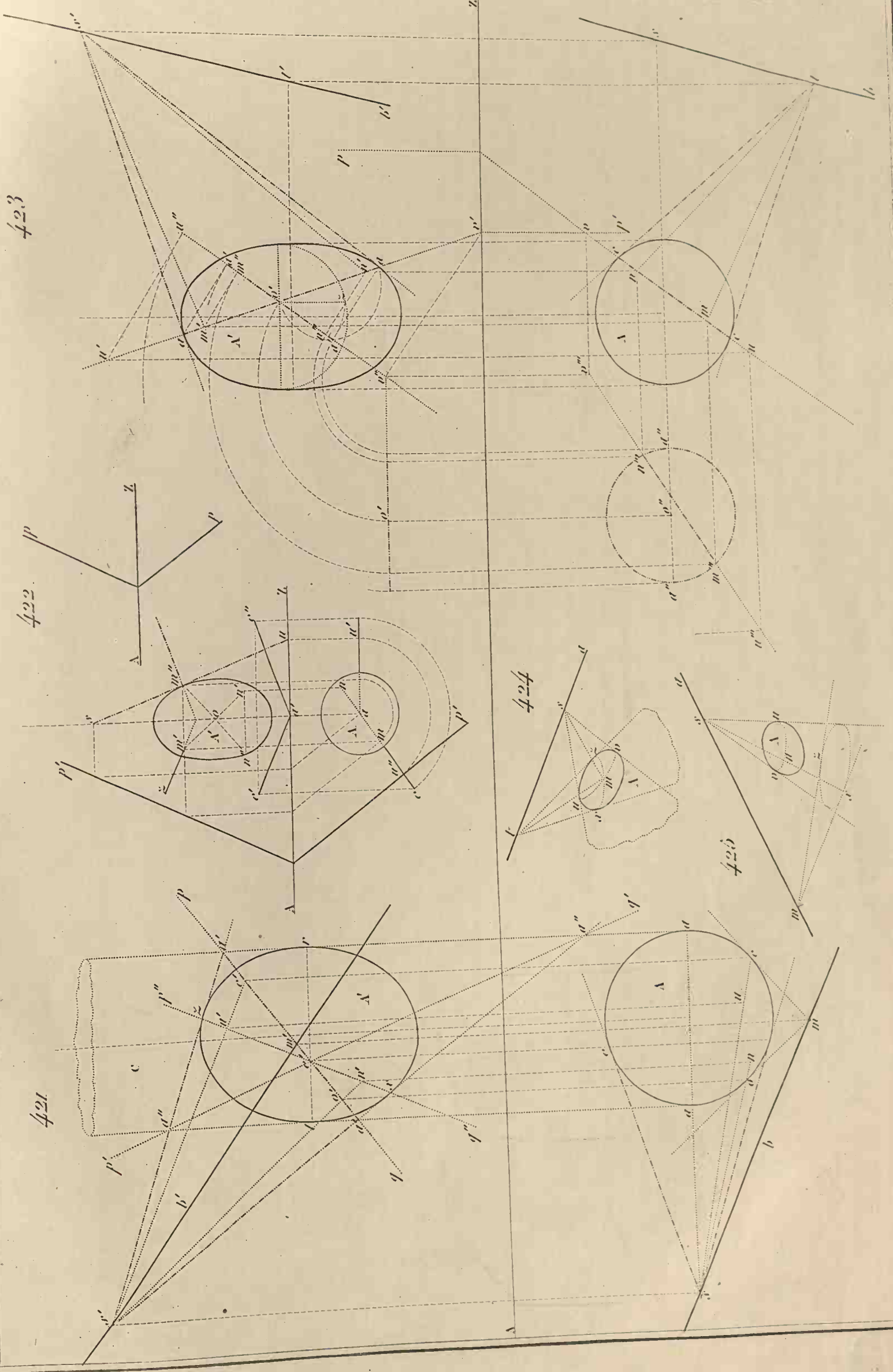

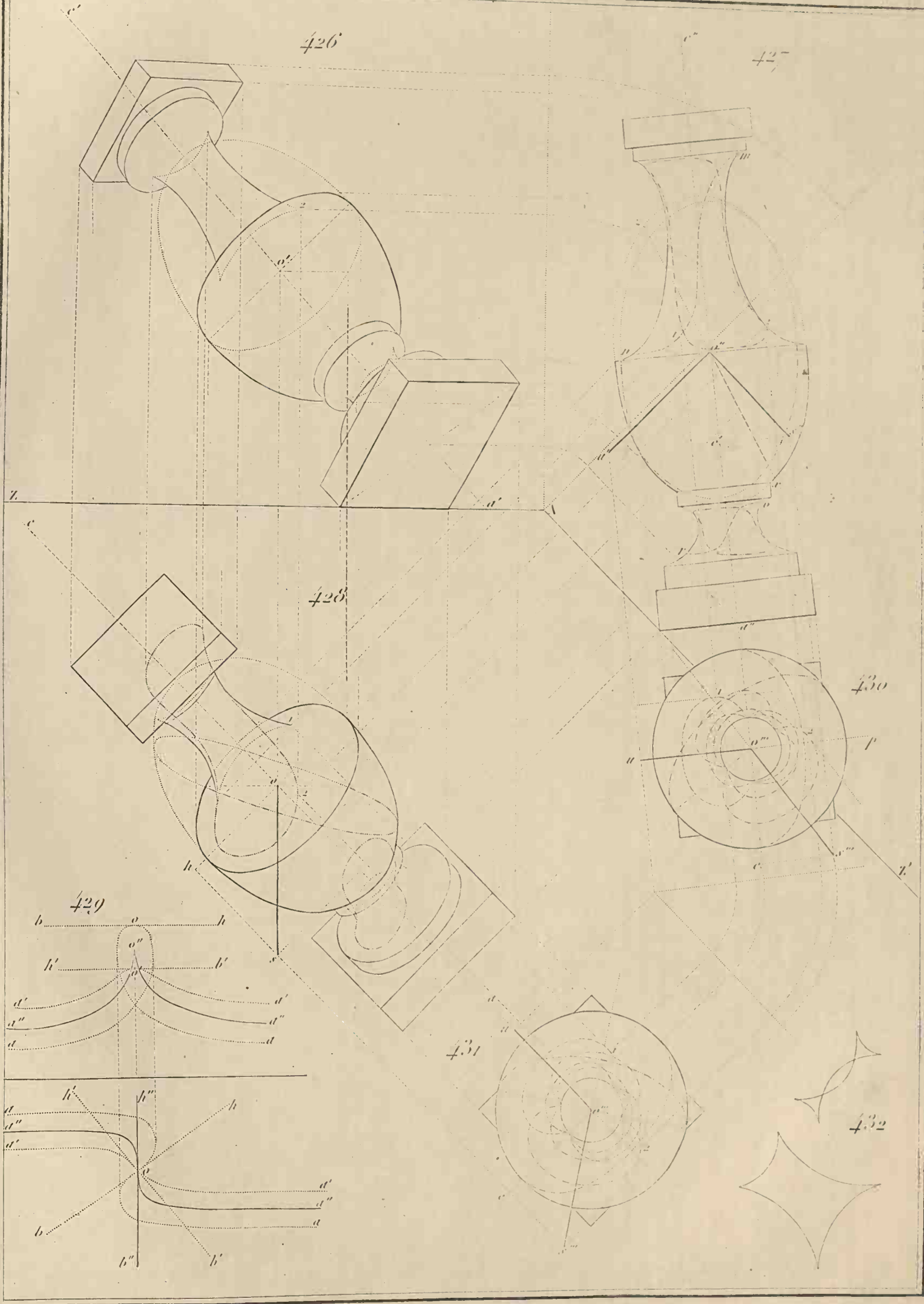

433

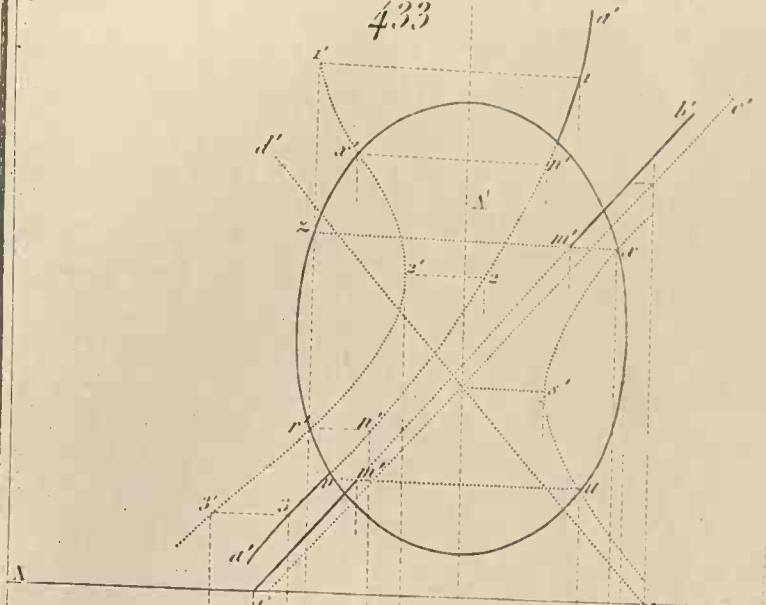

434

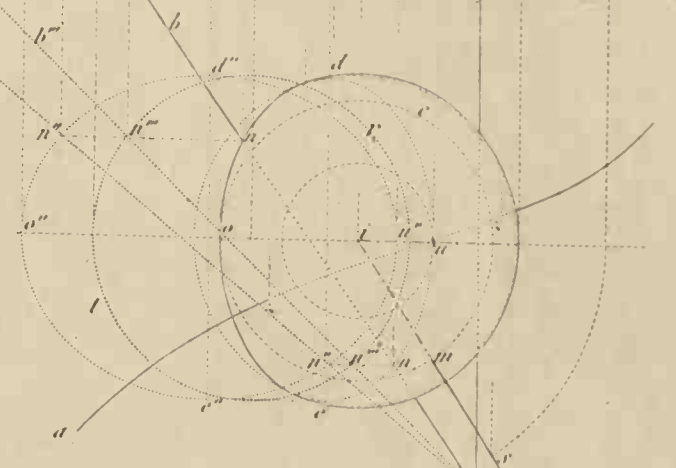
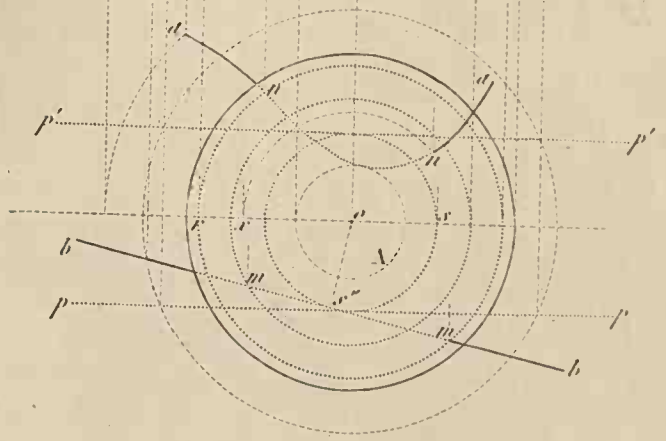
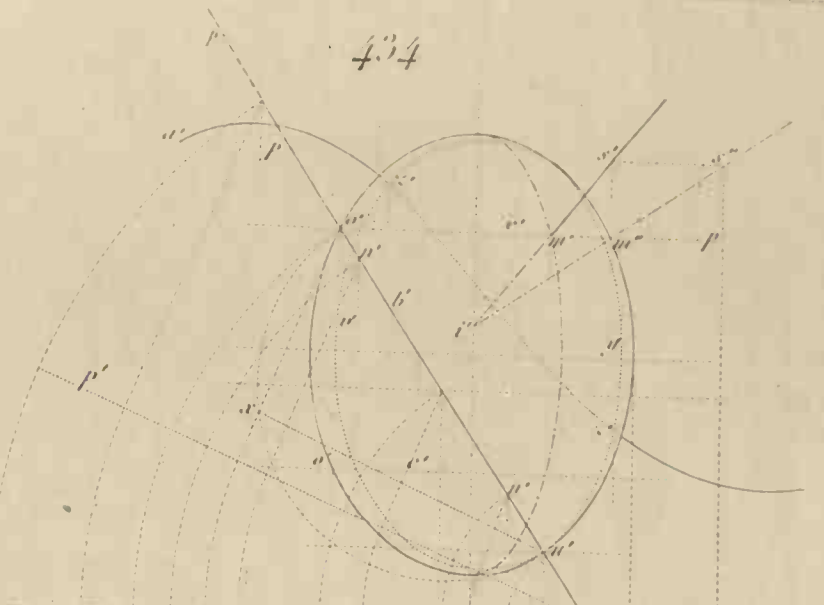

435

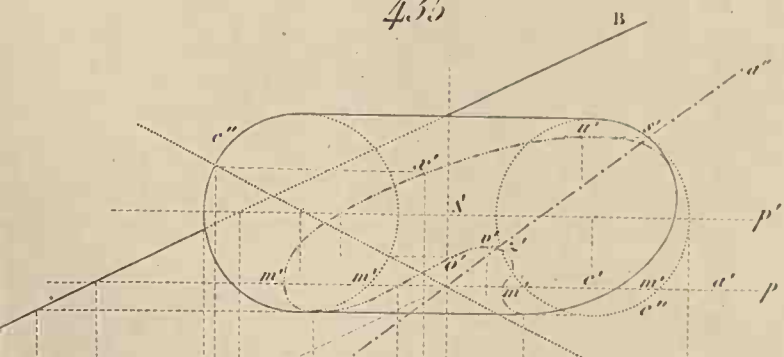

436

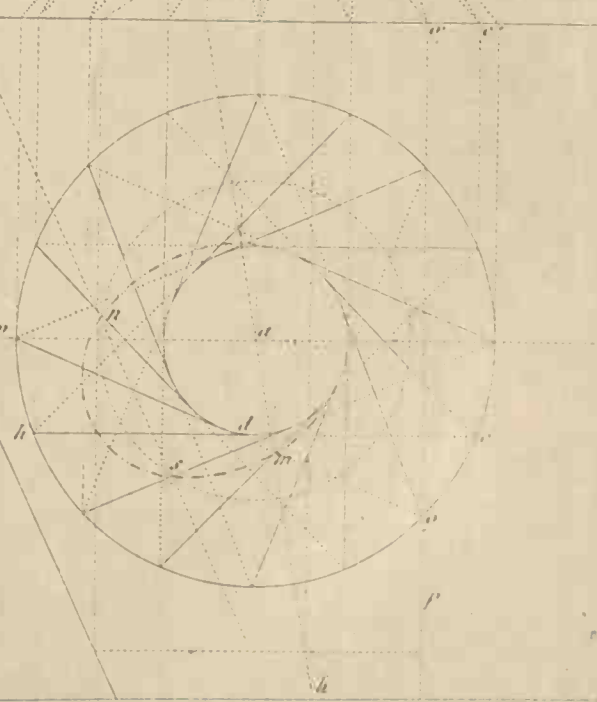
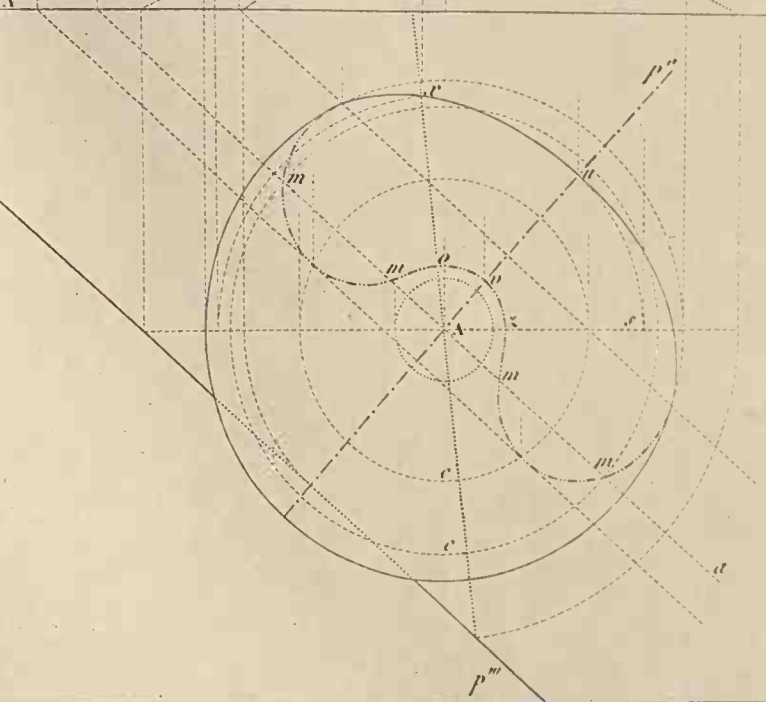
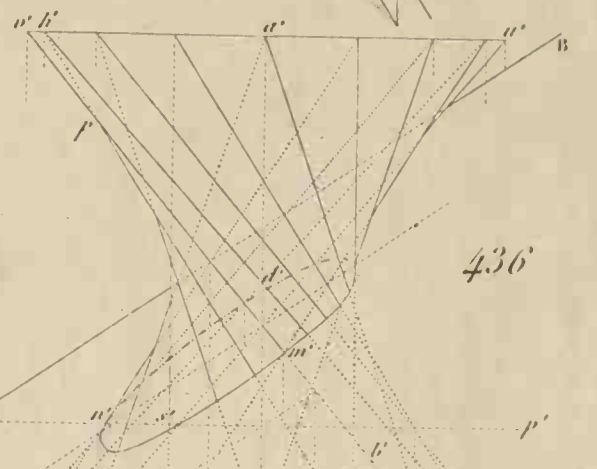

437

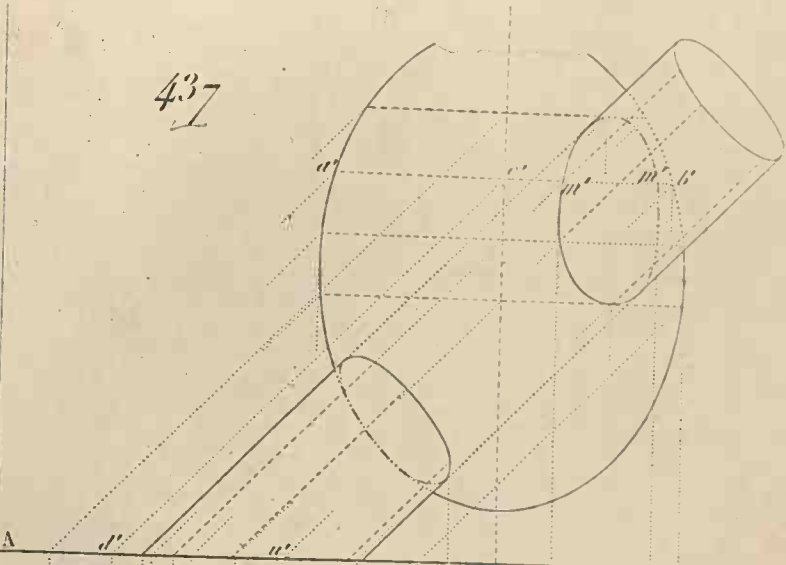

438

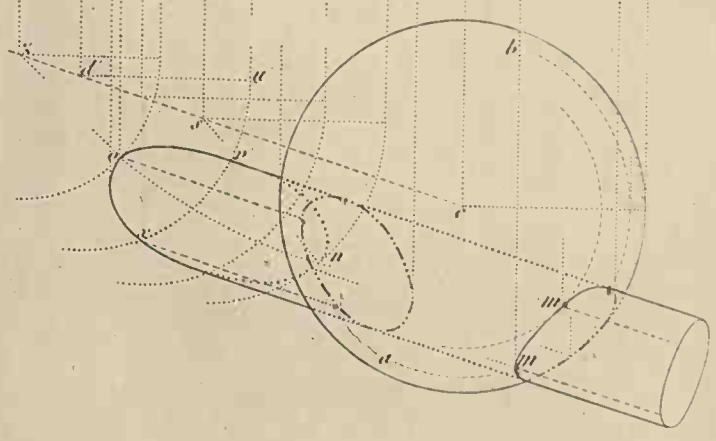
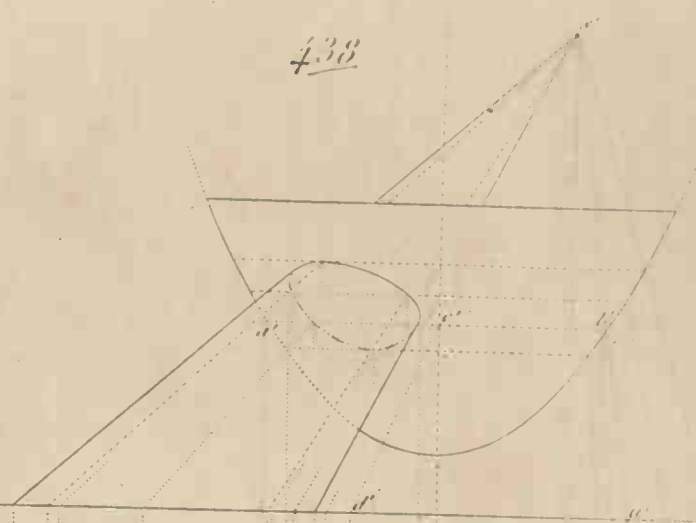

439

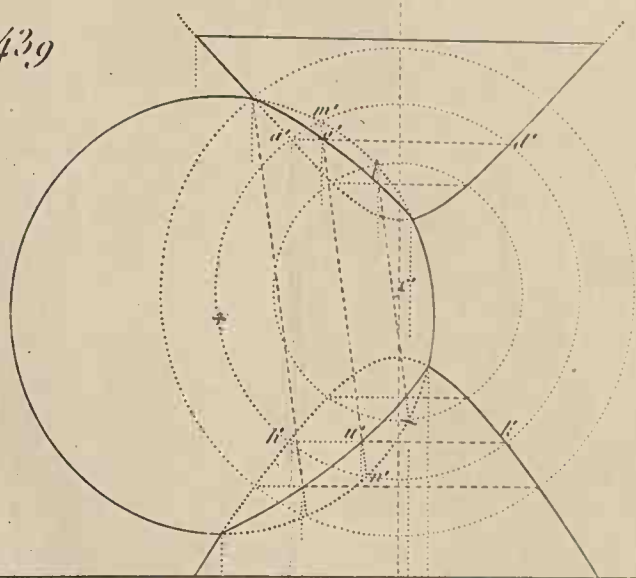

440

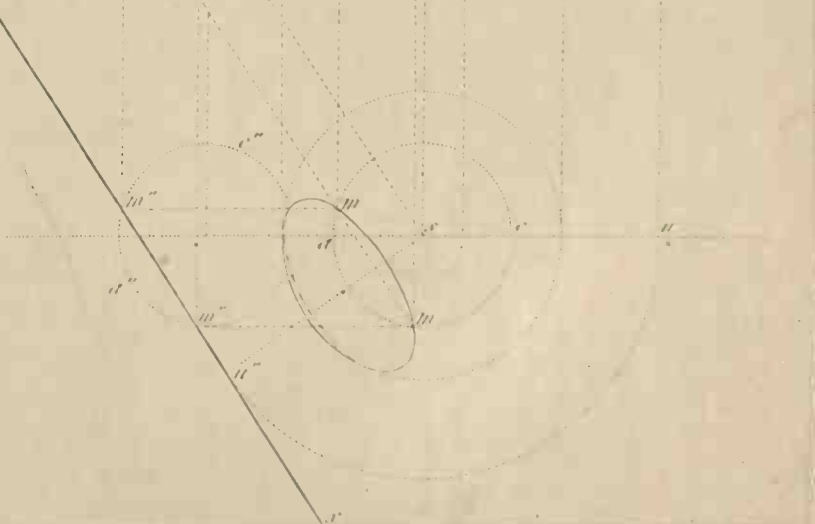
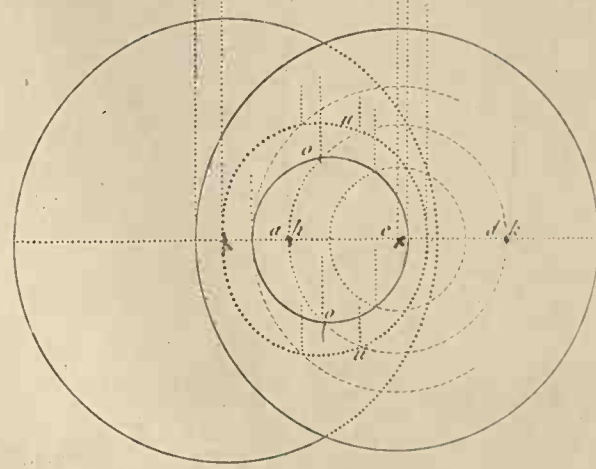
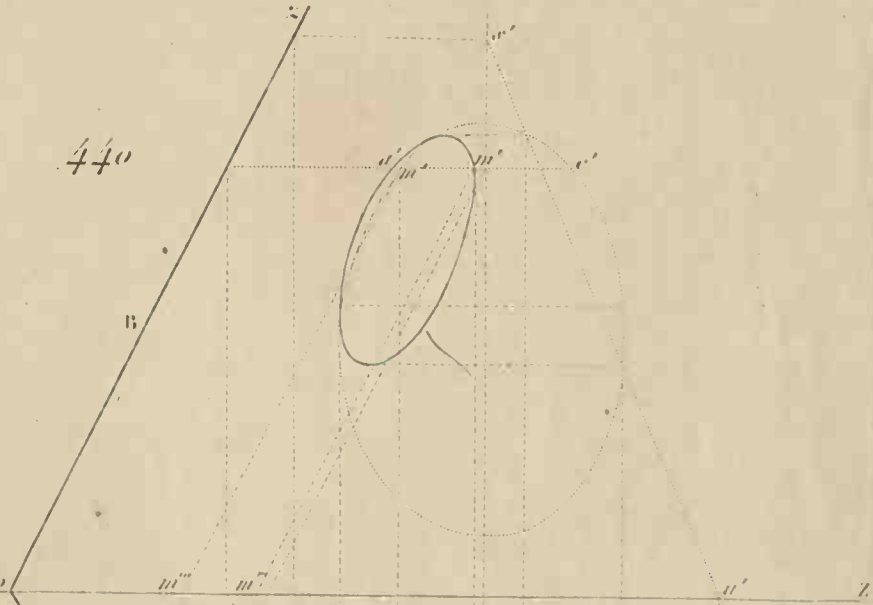

Surfaces de révolution.

Géométrie descriptive.

Pl. 89.

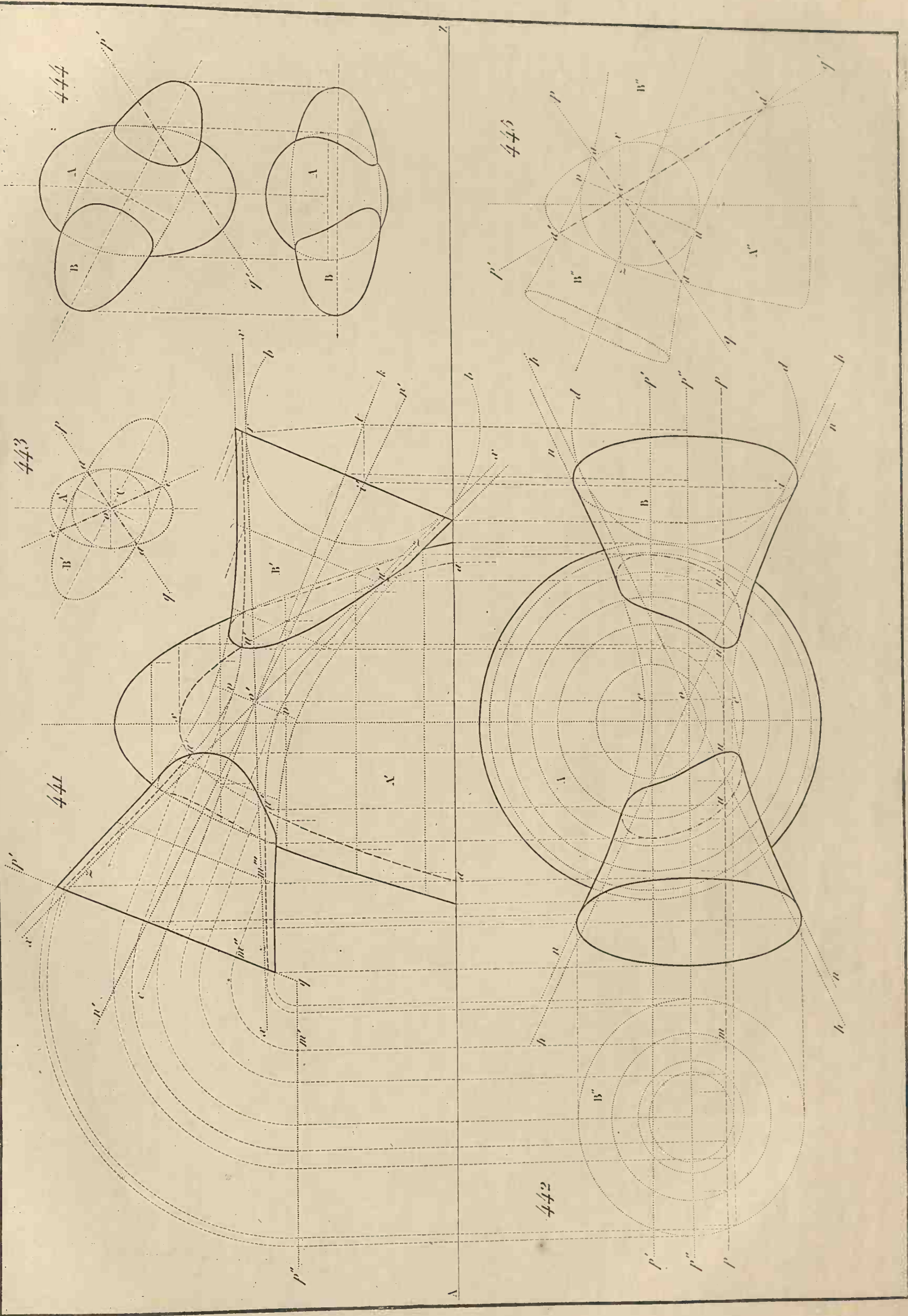

446

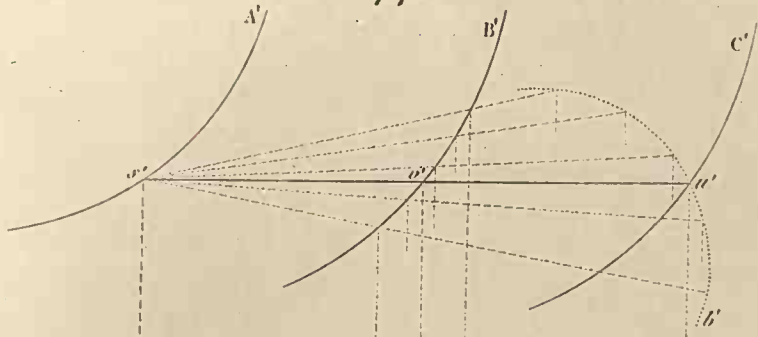

447

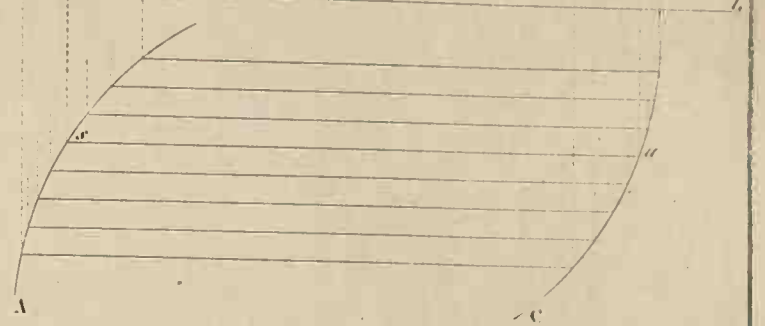
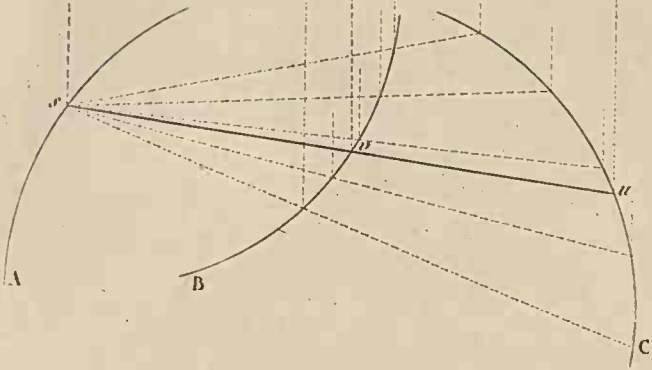
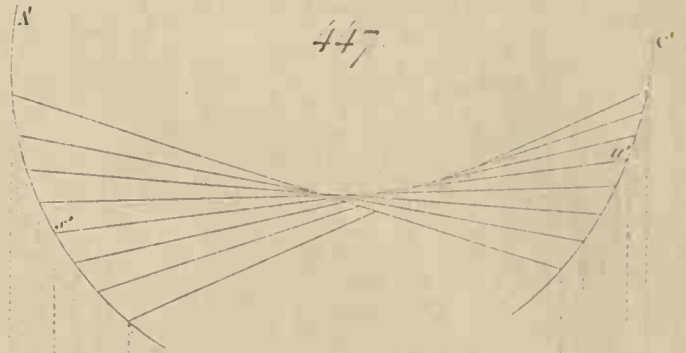

448

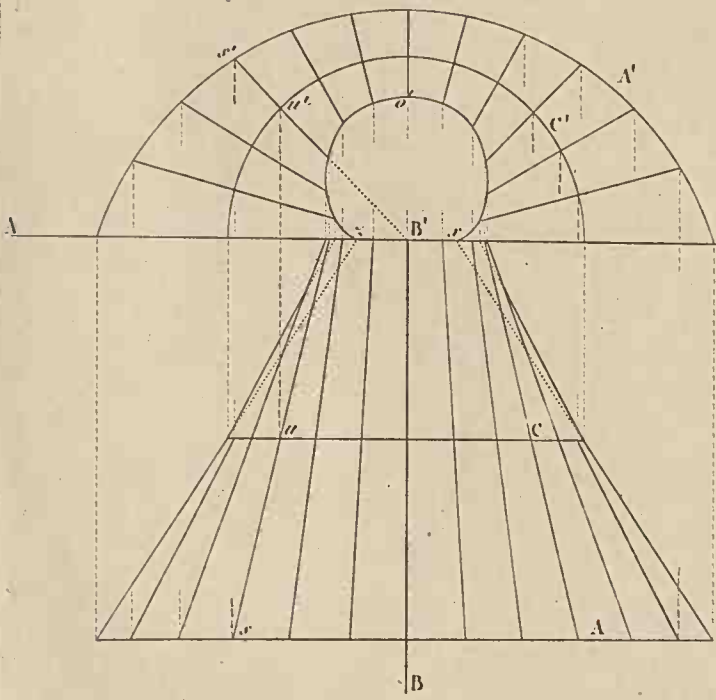

449

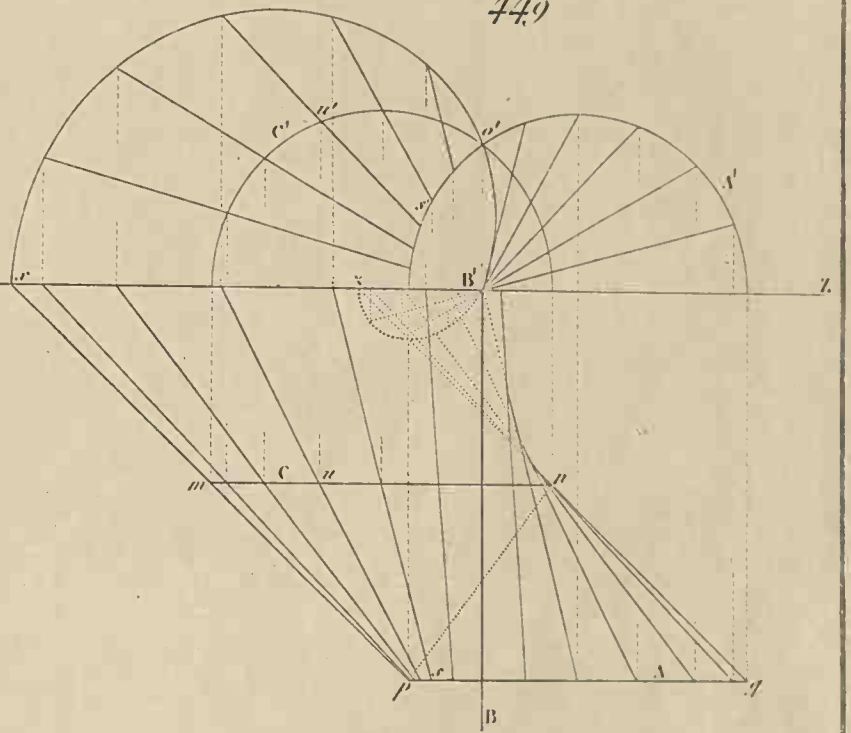

450

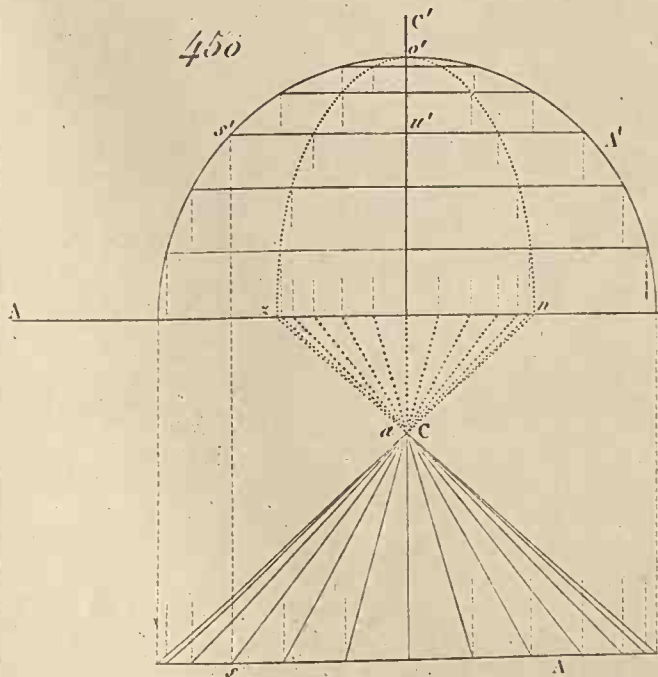

451

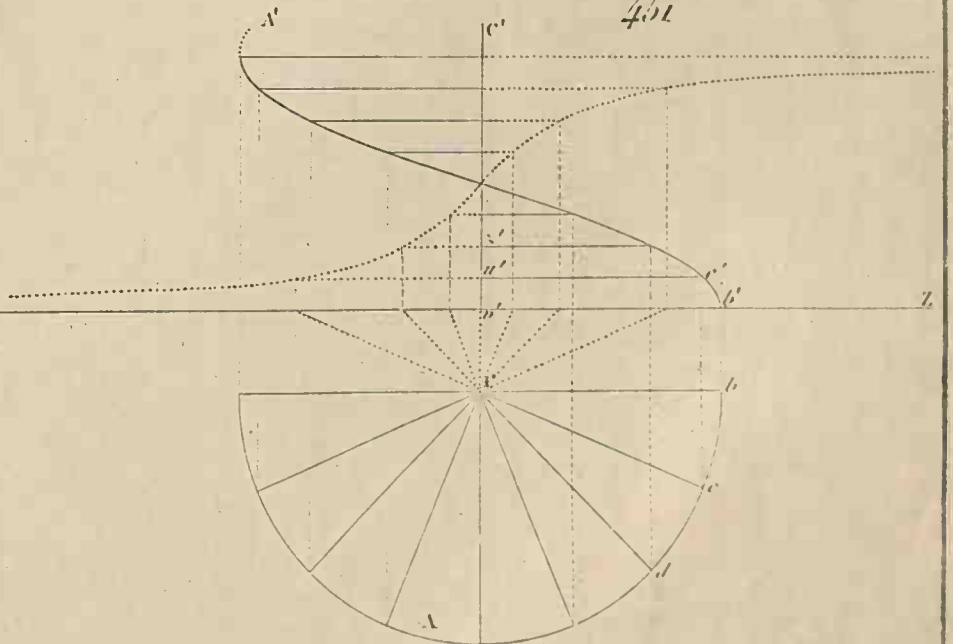

452

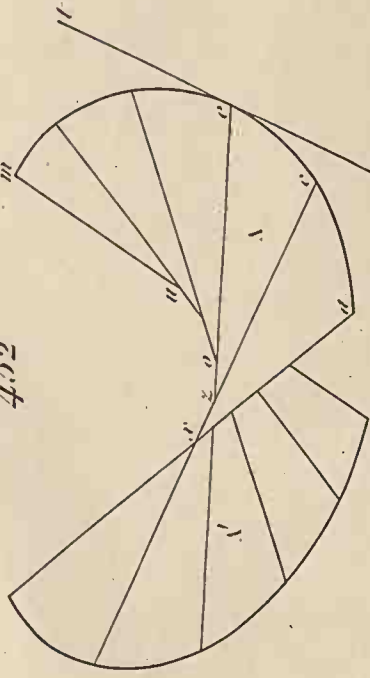

453

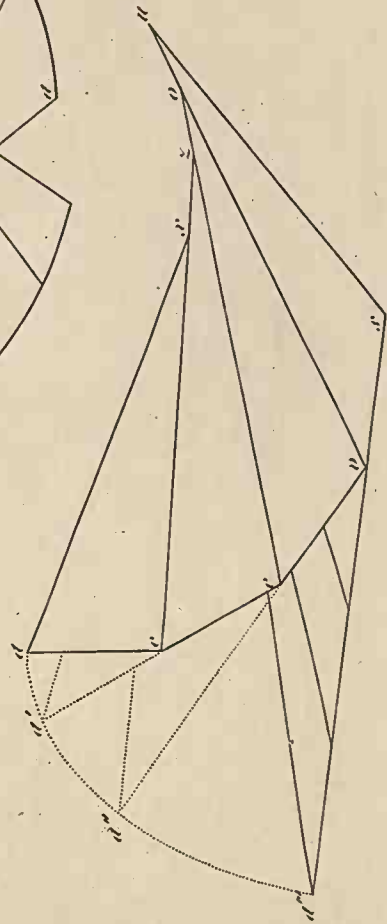

454

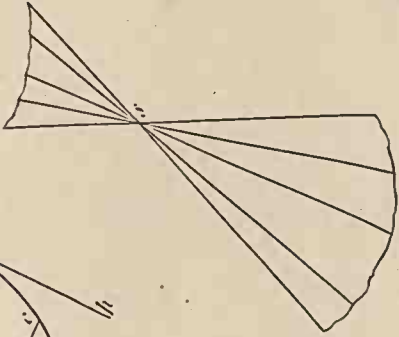

455

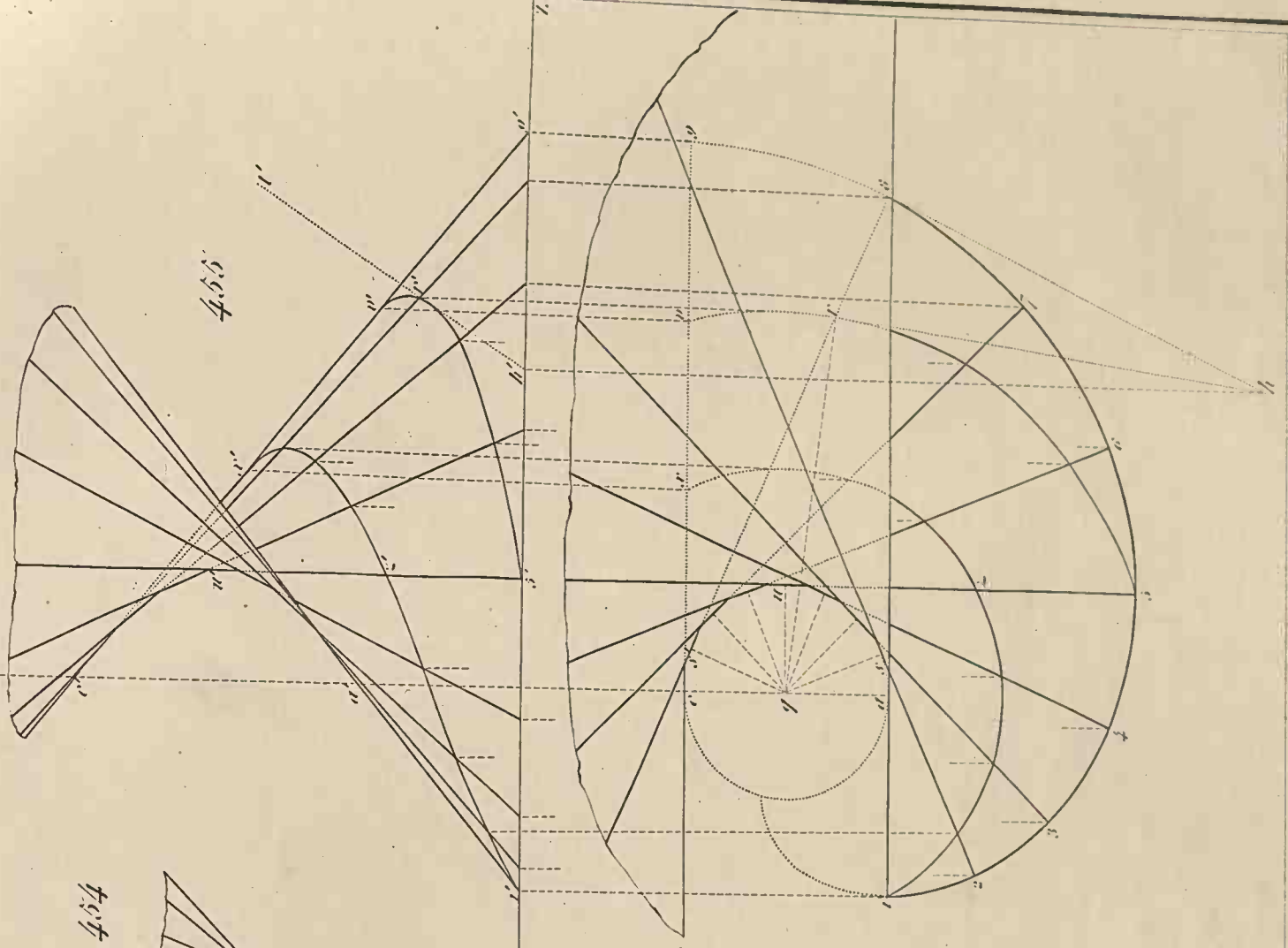

456

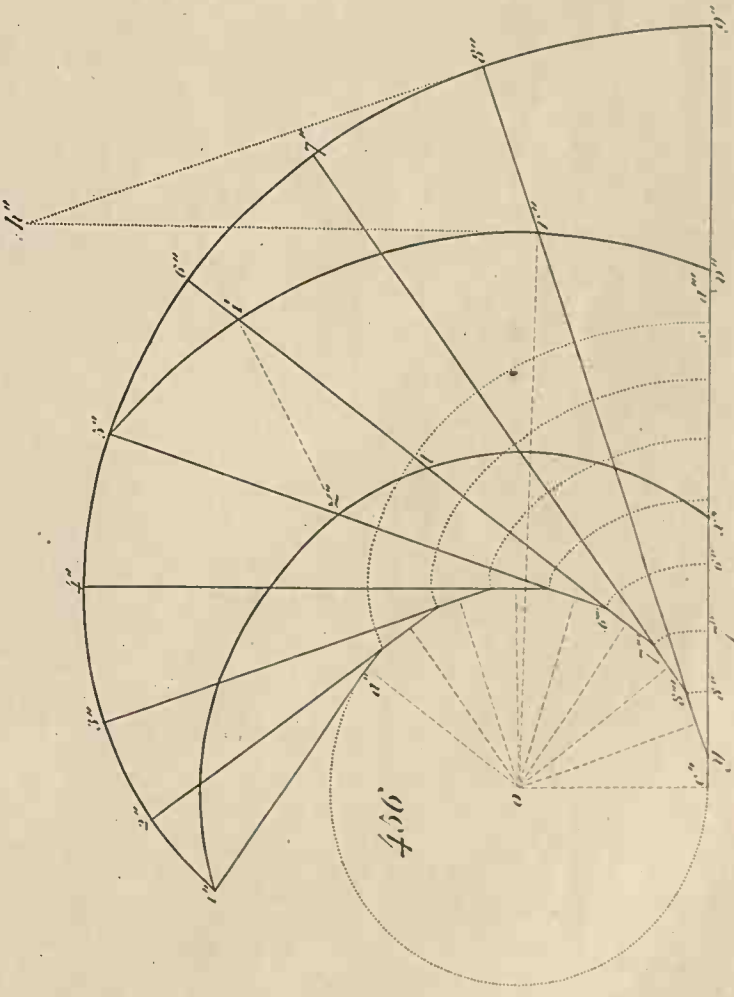

457

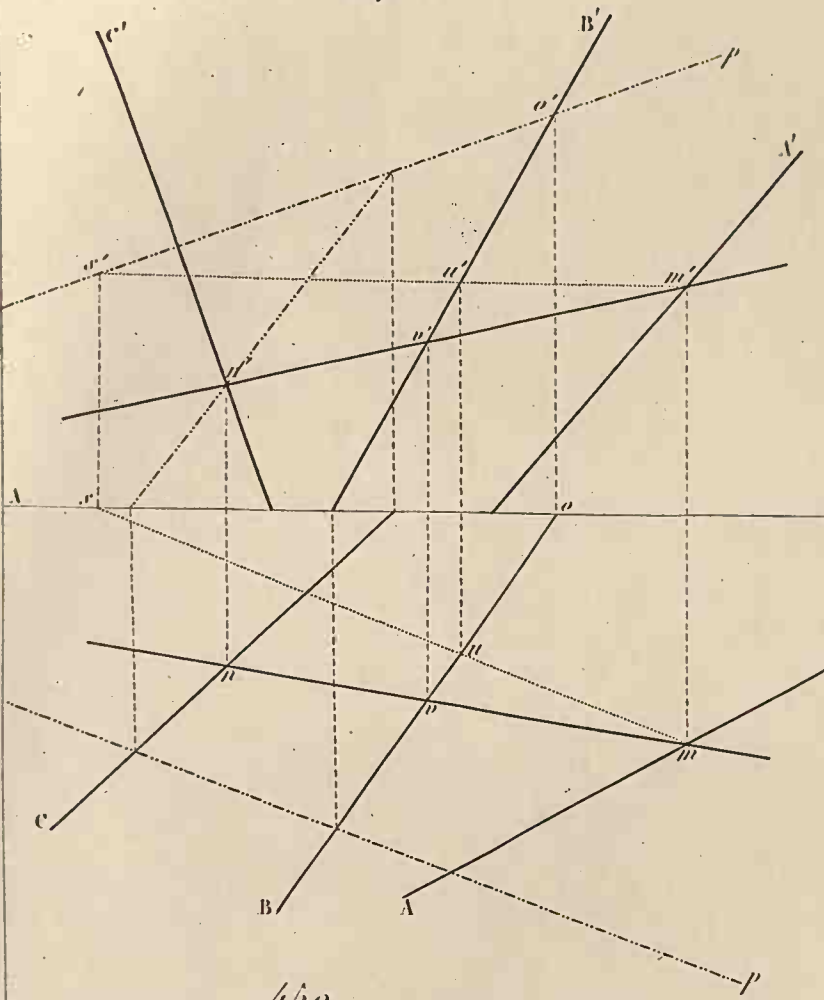

458

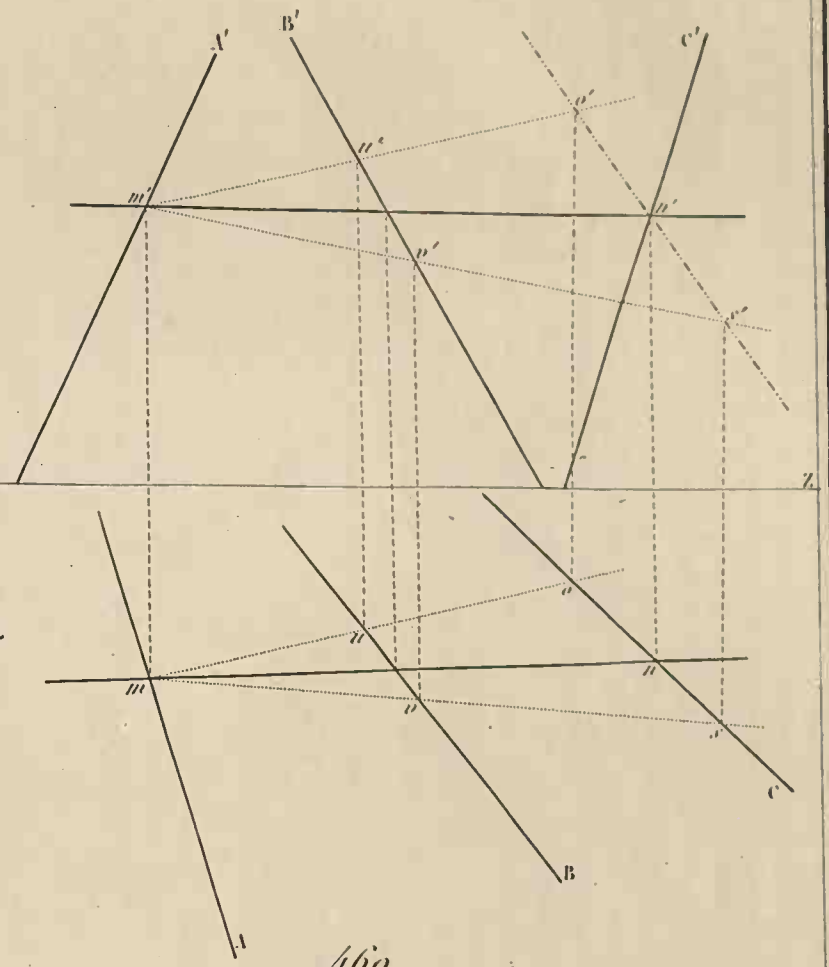

459

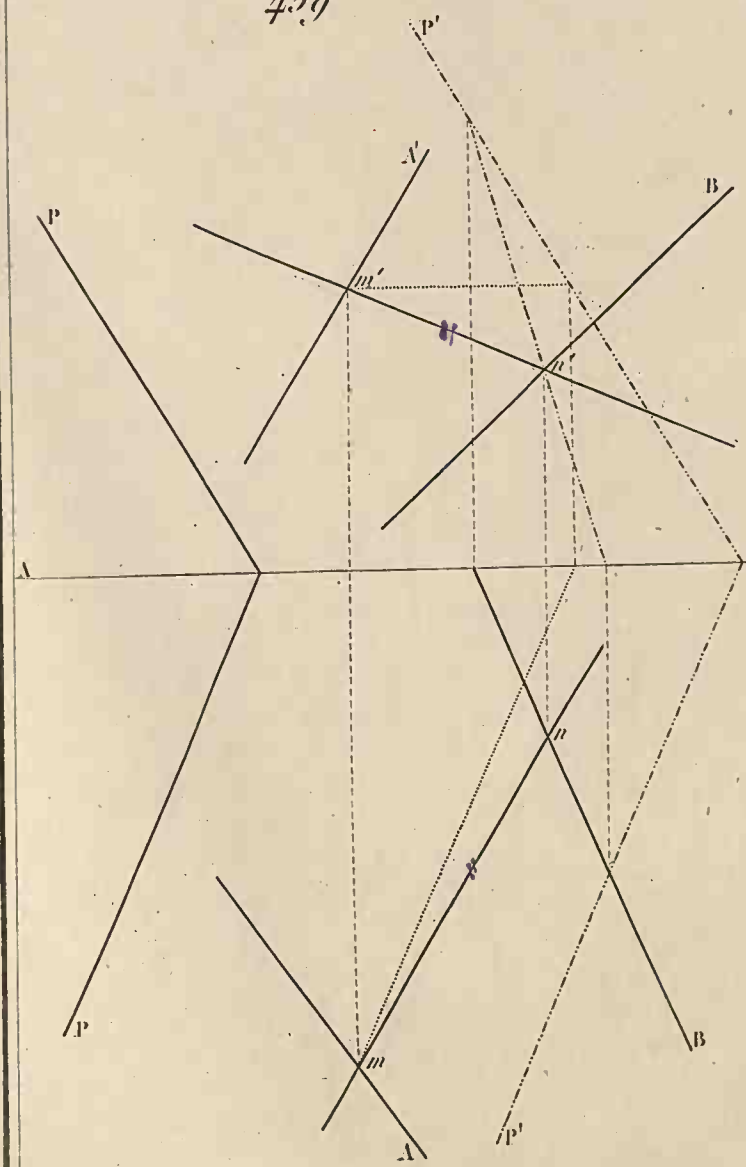

460

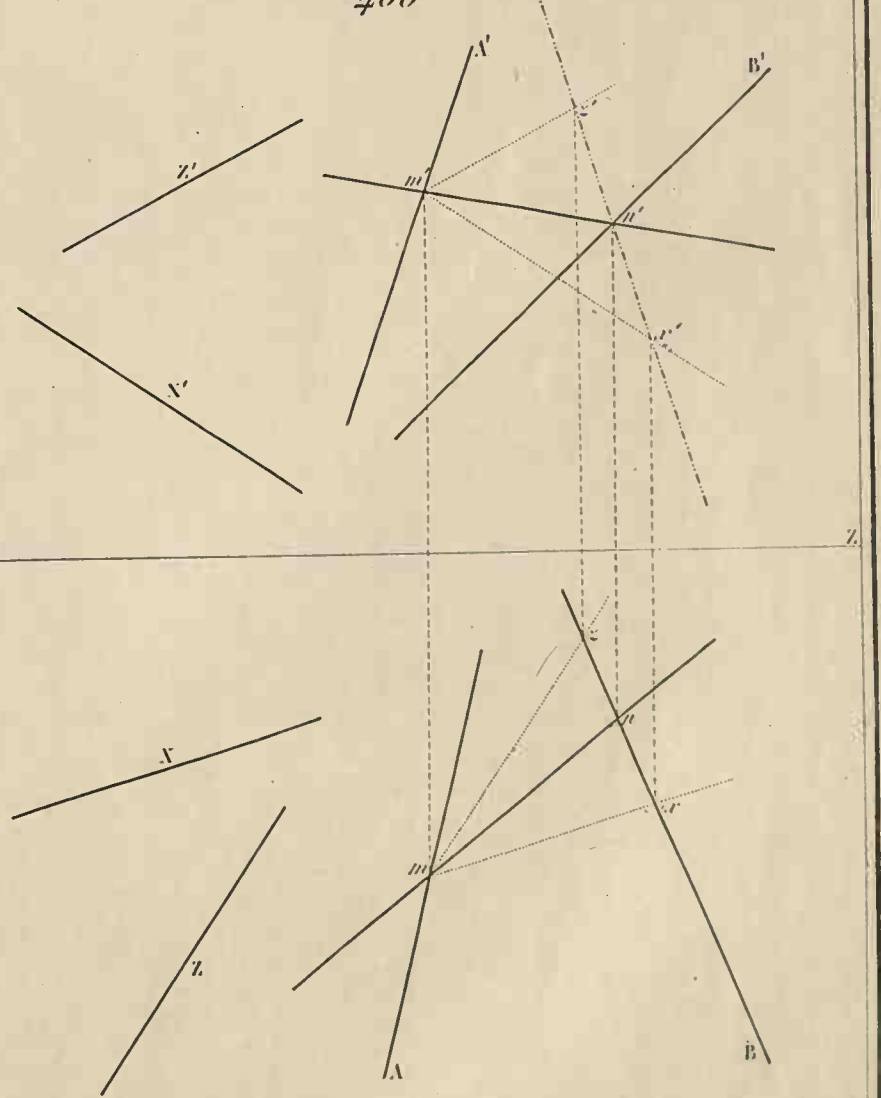

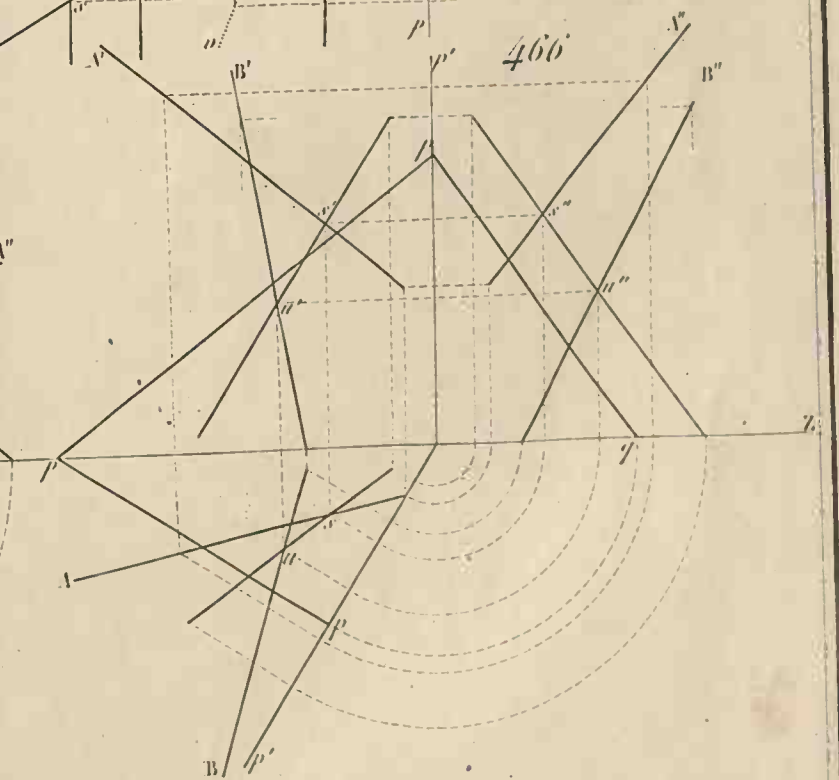
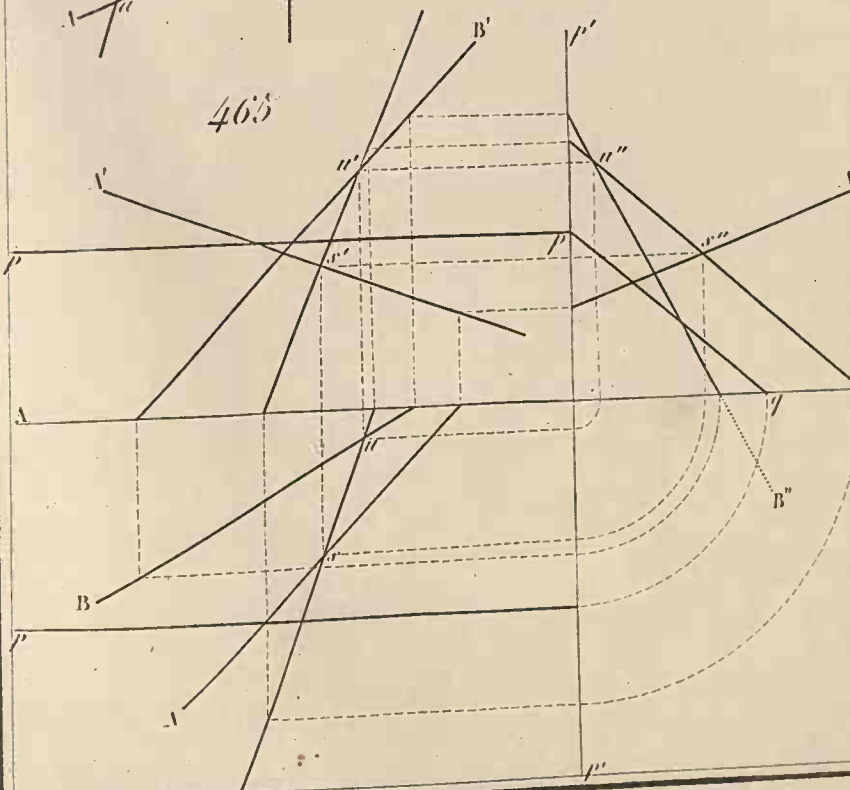
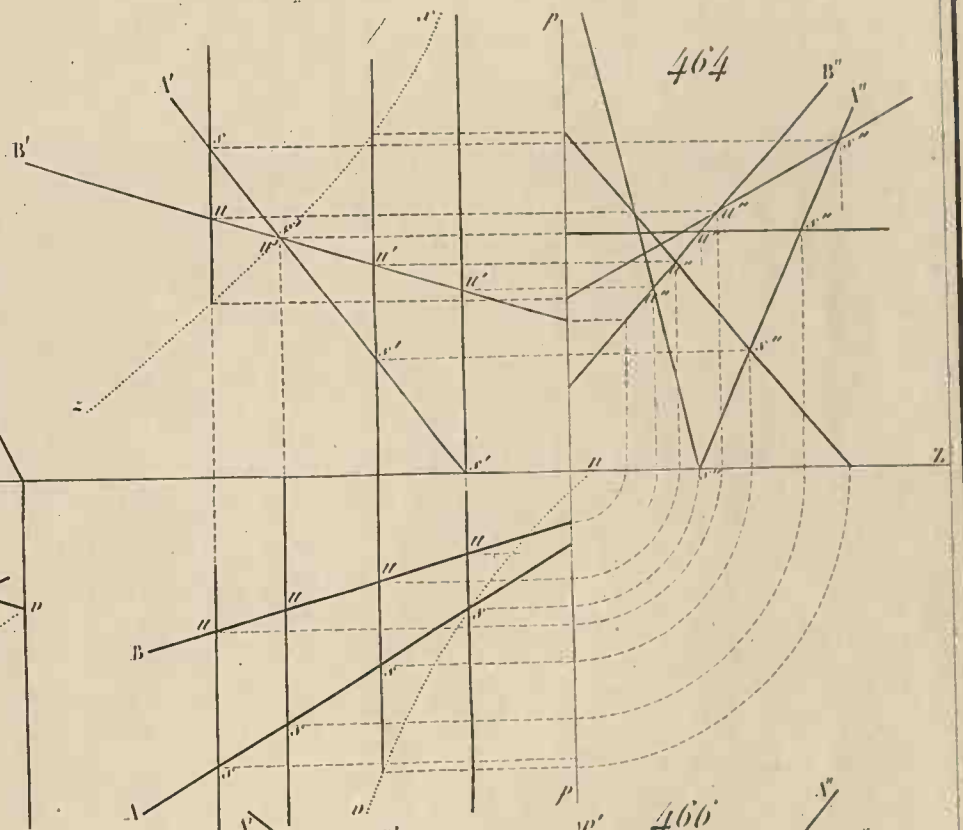
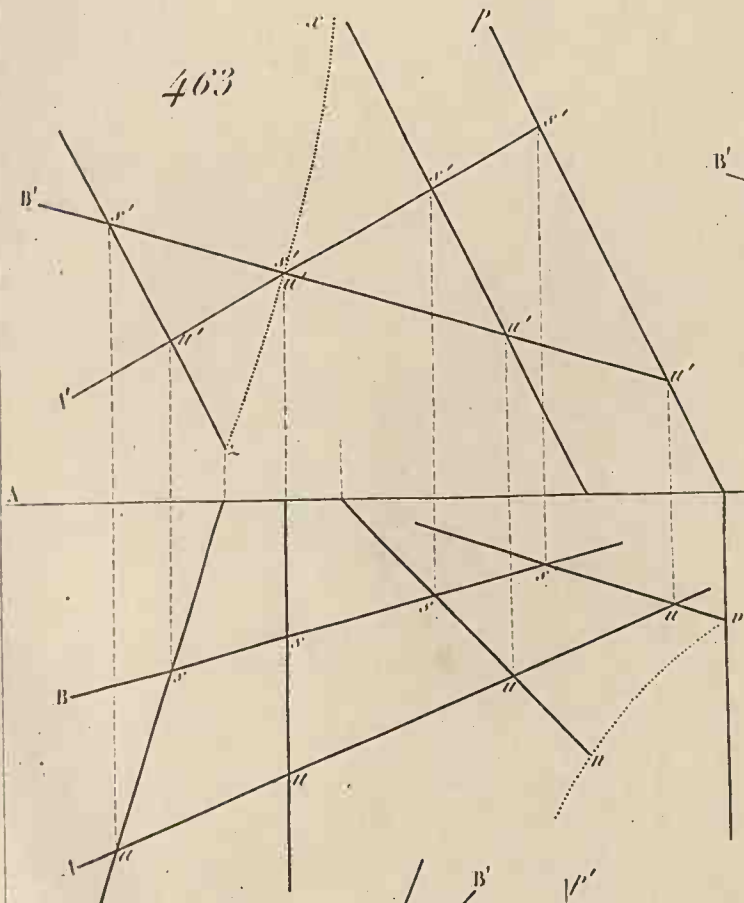
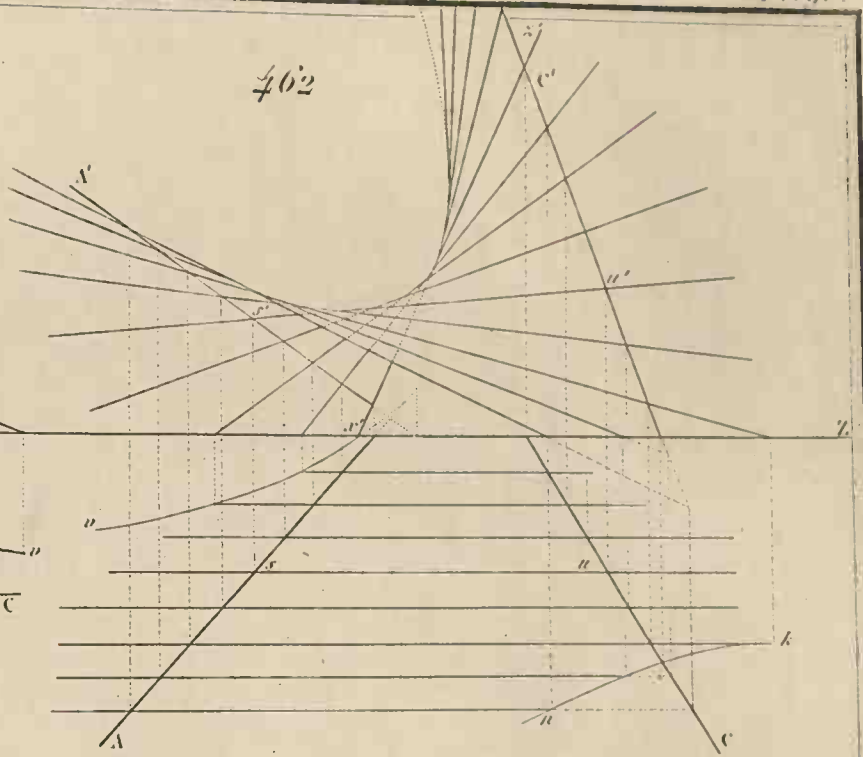
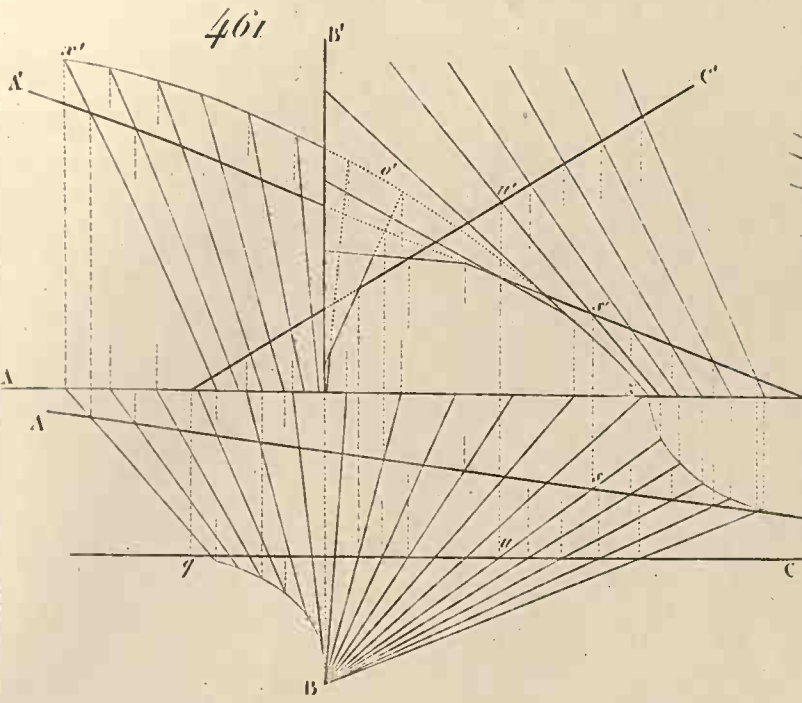

467

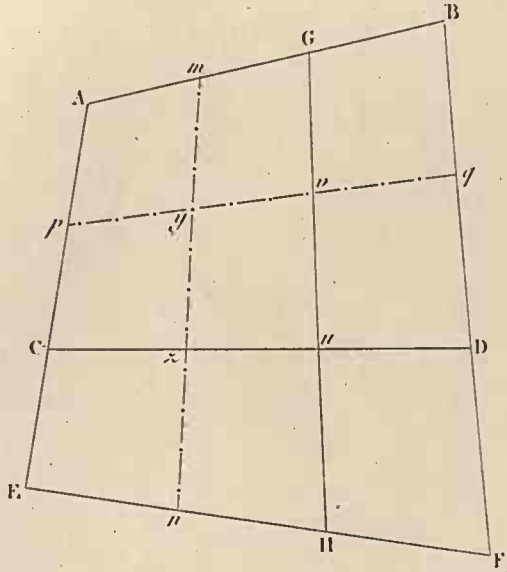

468

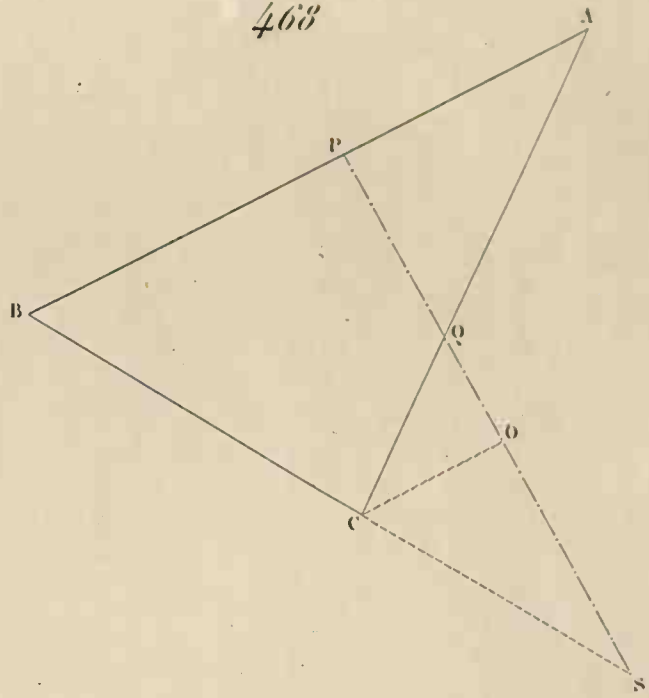

469

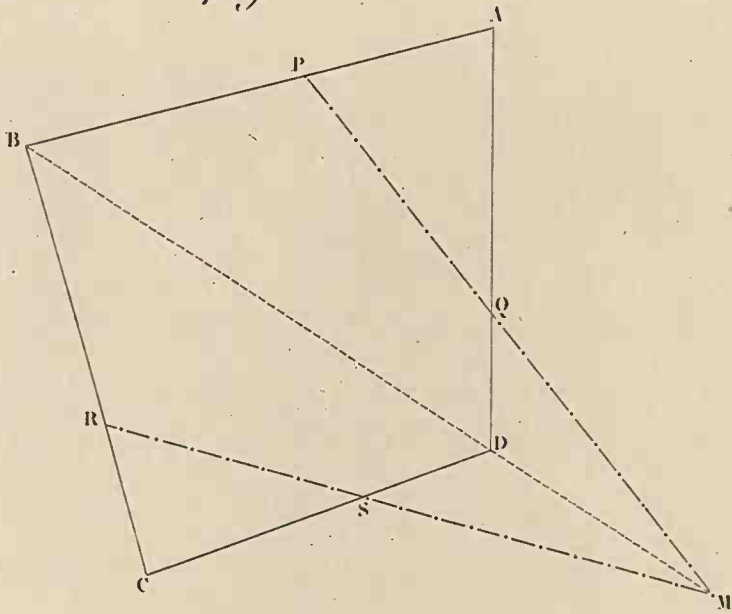

470

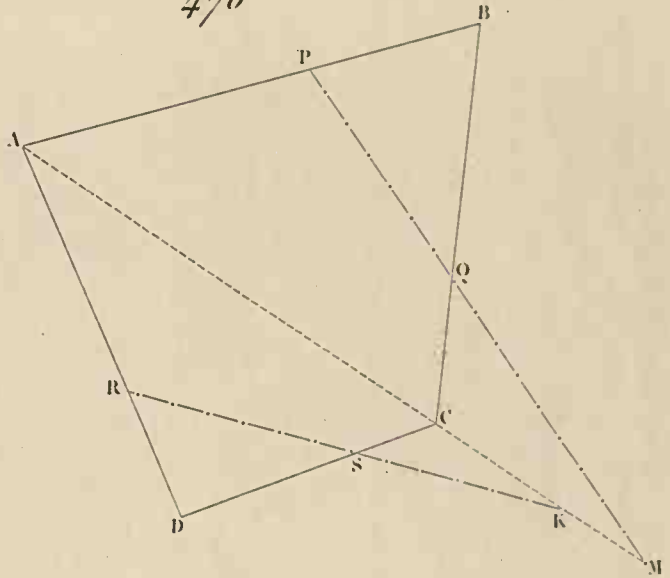

471

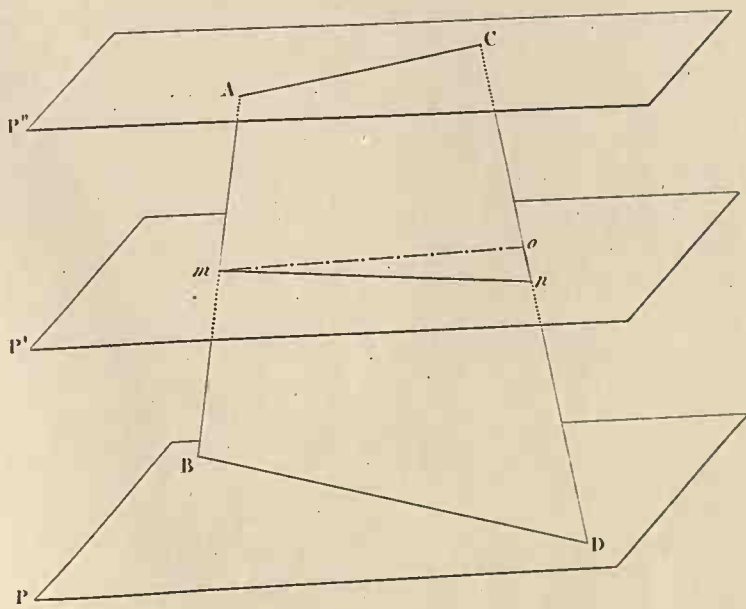

472

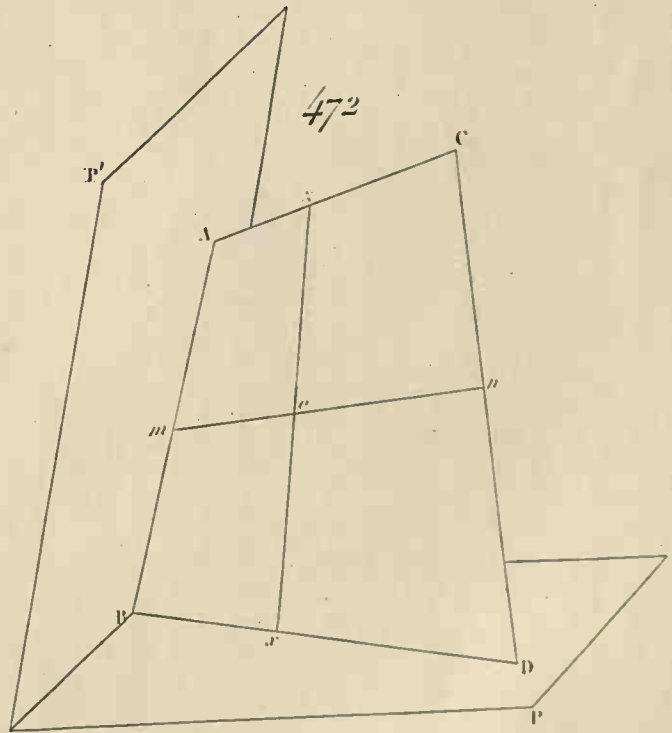

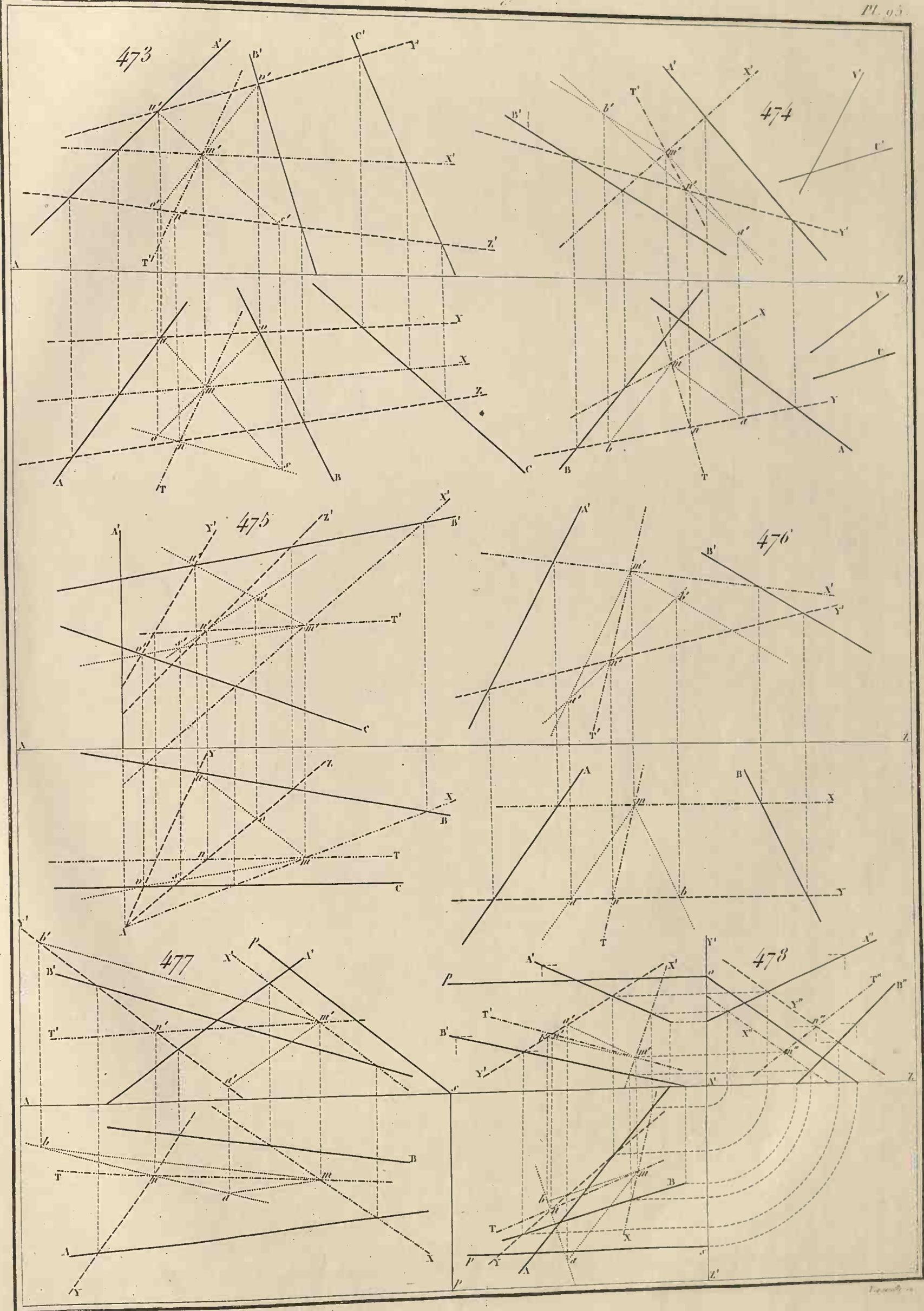

Géométrie descriptive.

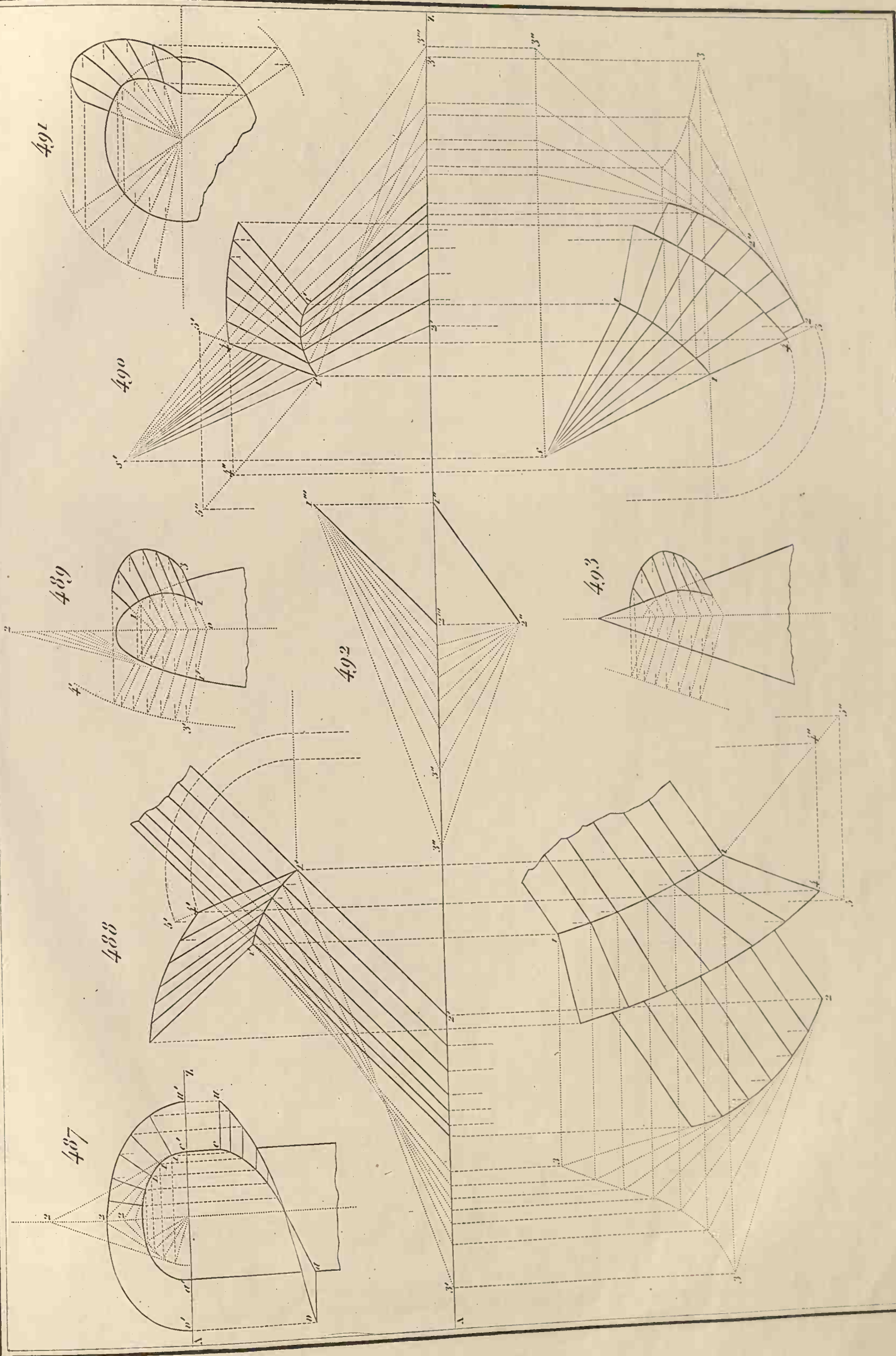

479

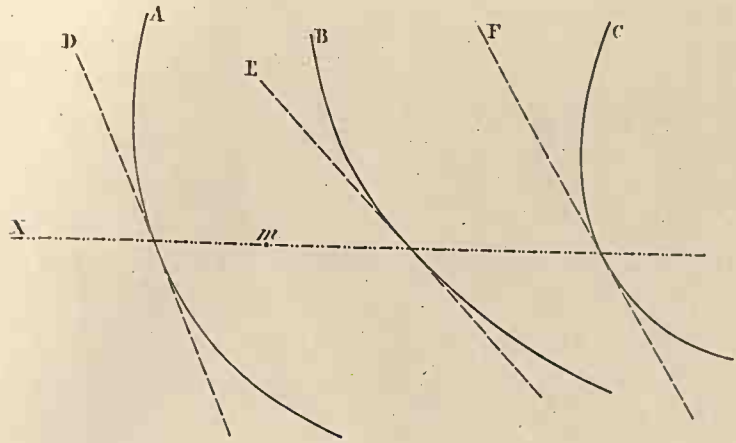

480

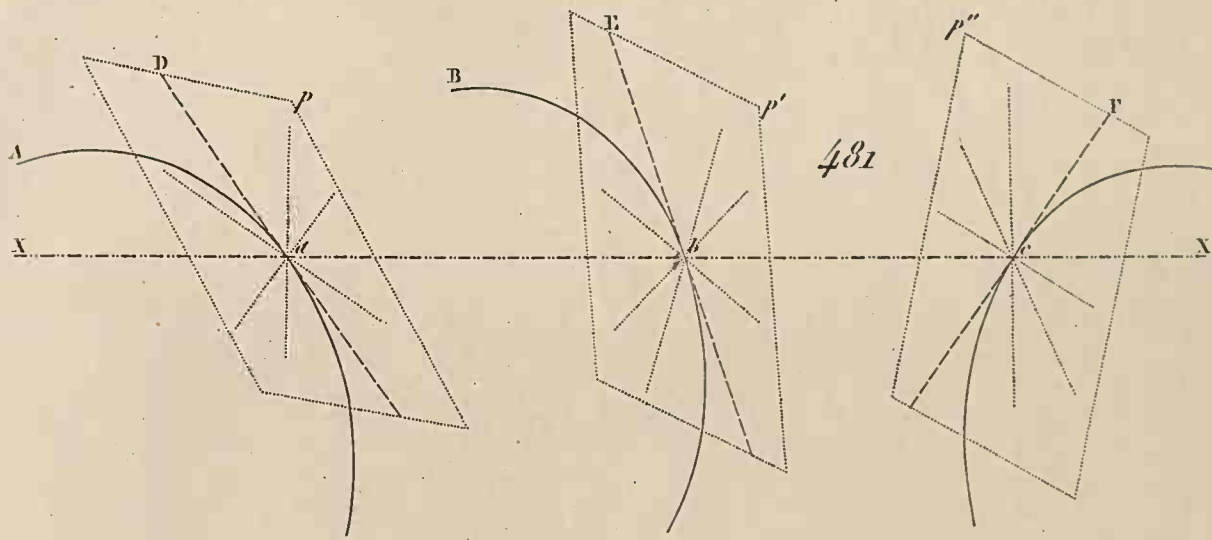
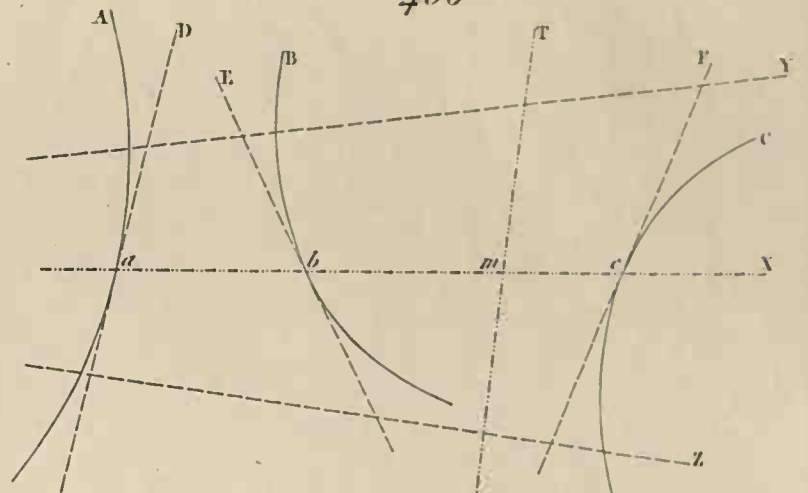

481

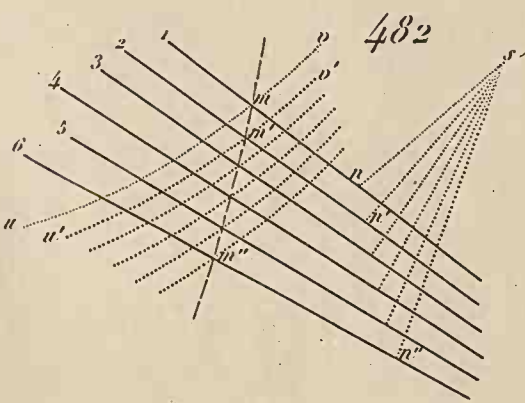

482

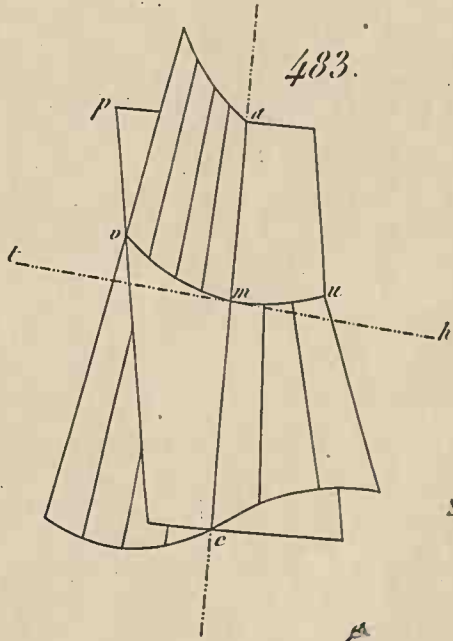

483

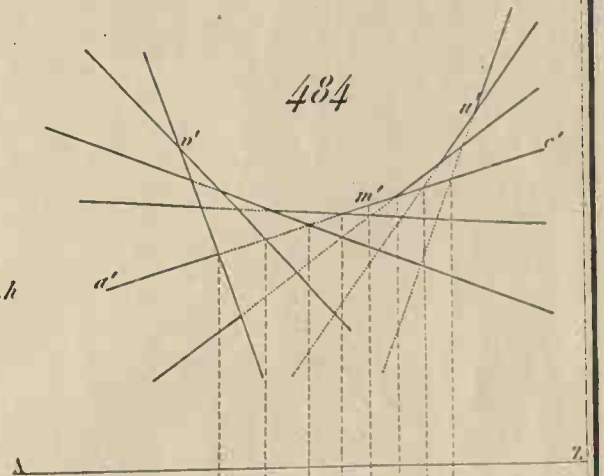

484

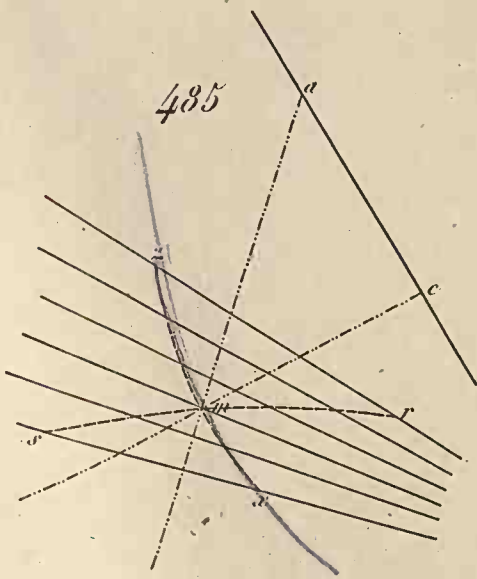

485

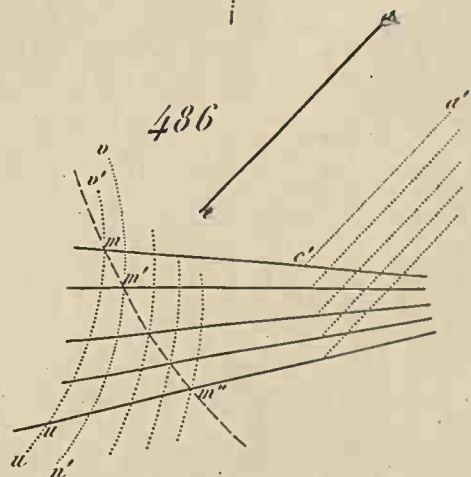

486

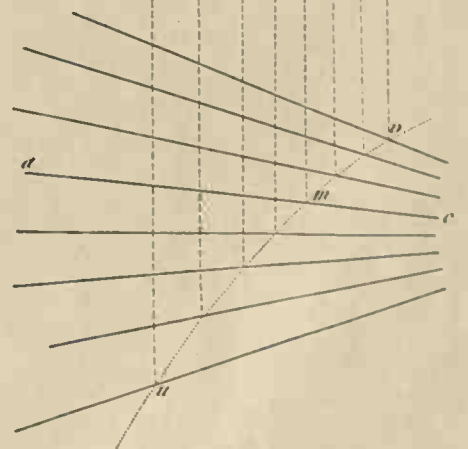

494

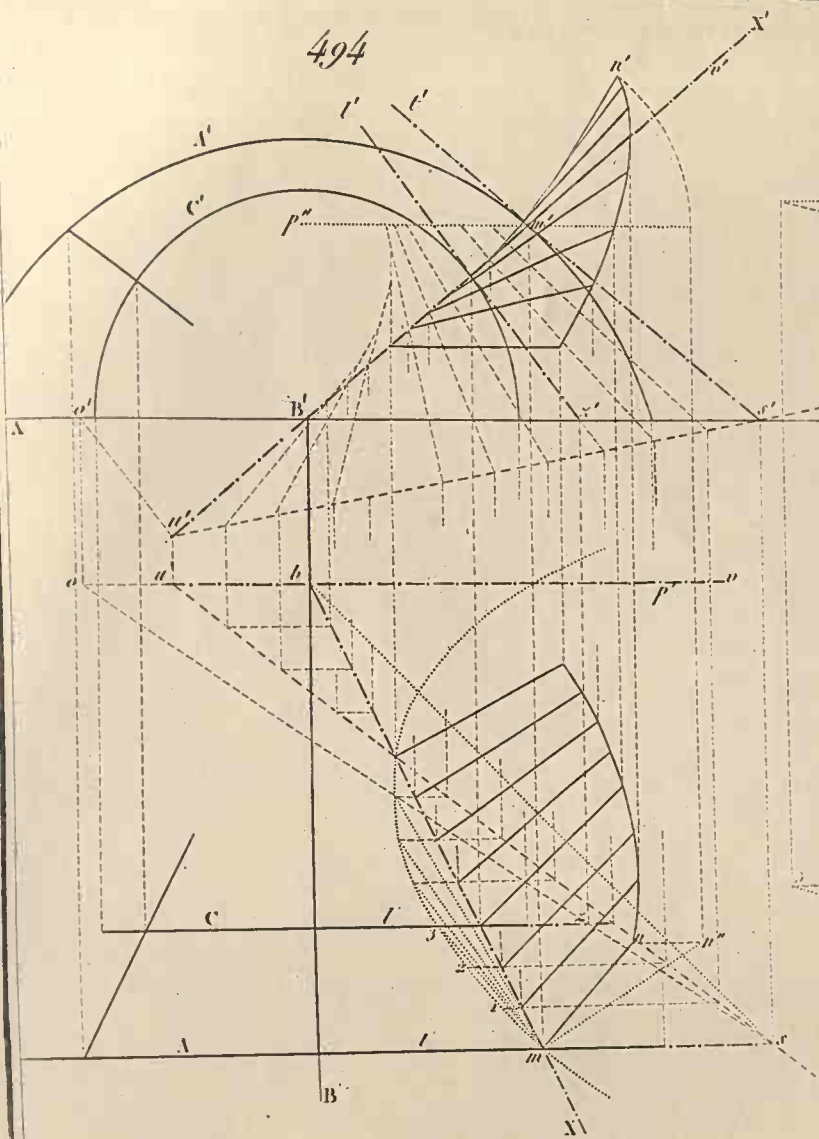

495

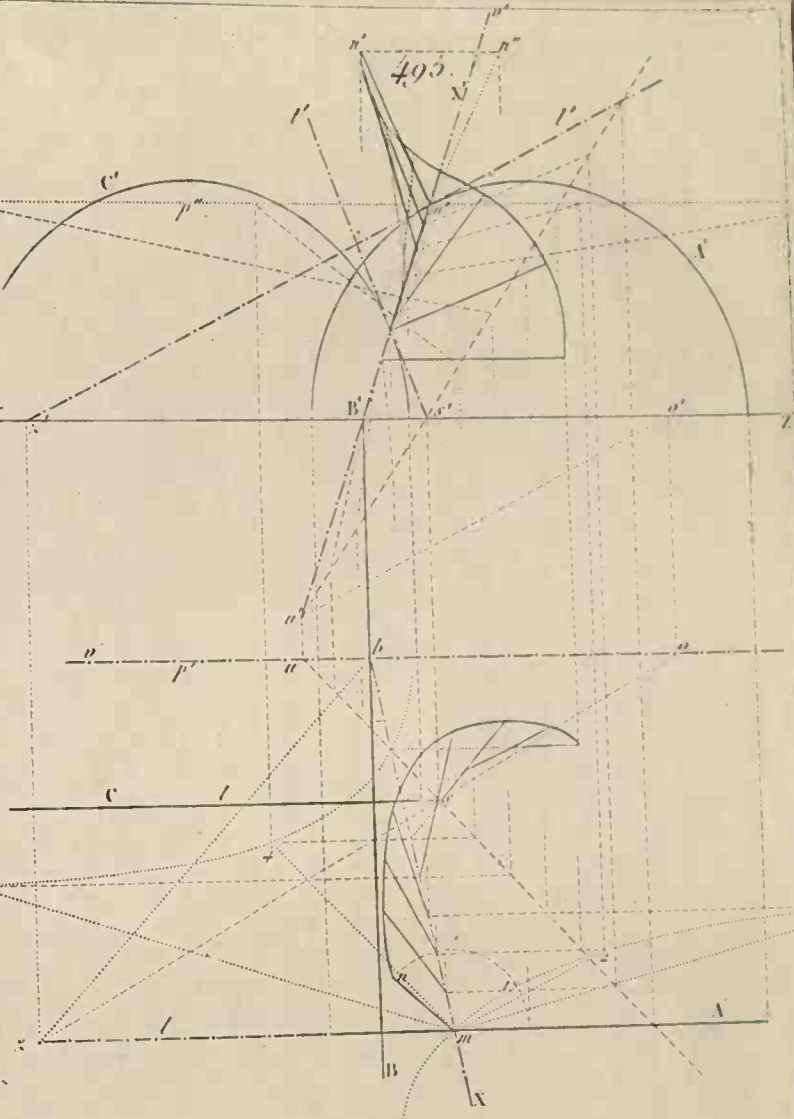

496

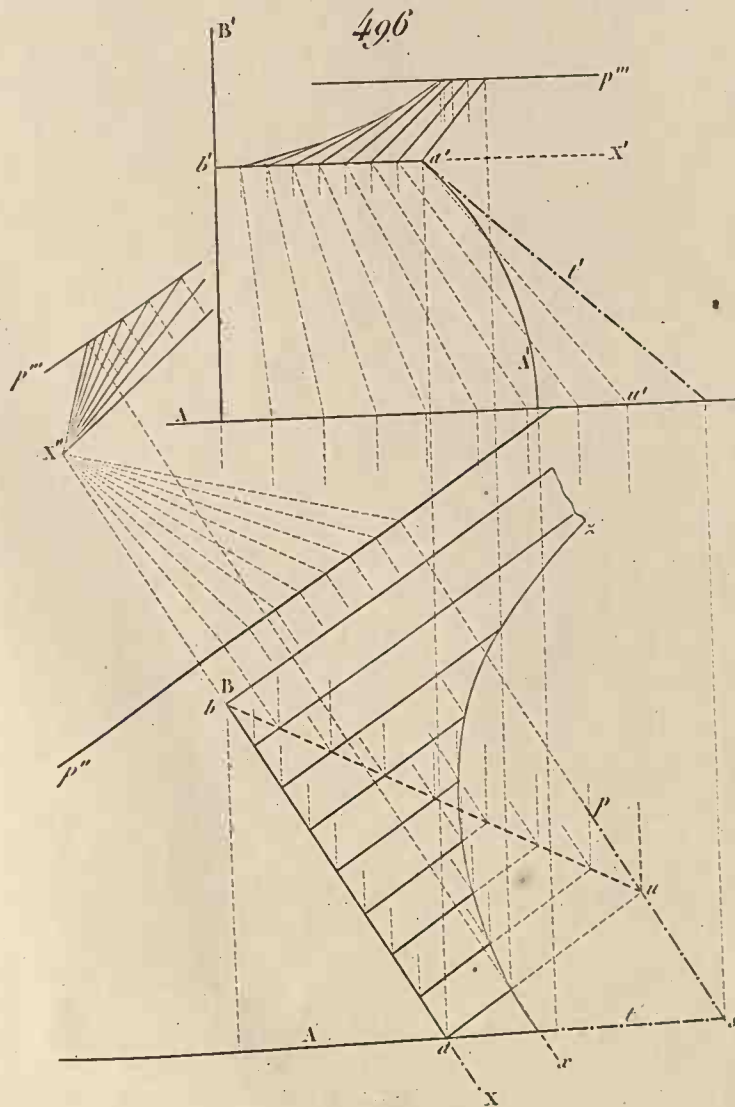

497

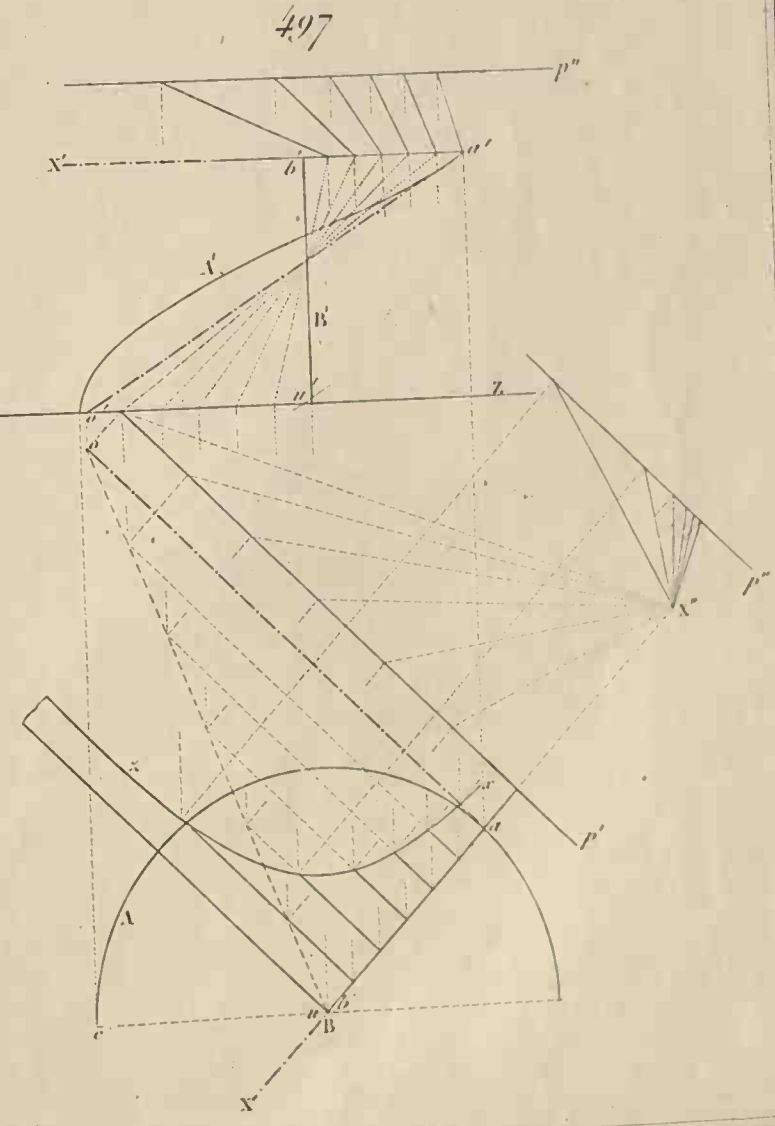

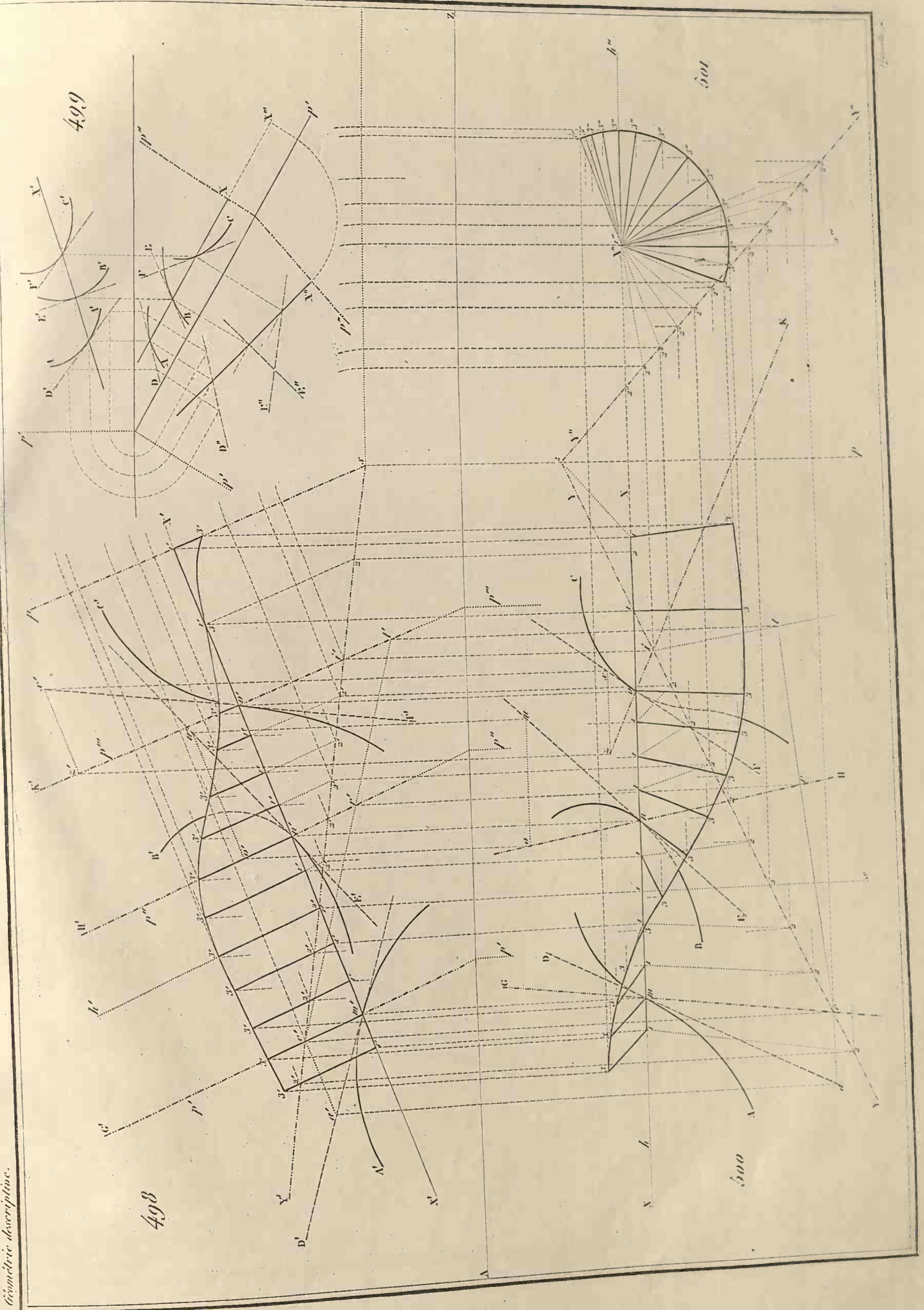

502

503

505

504

506

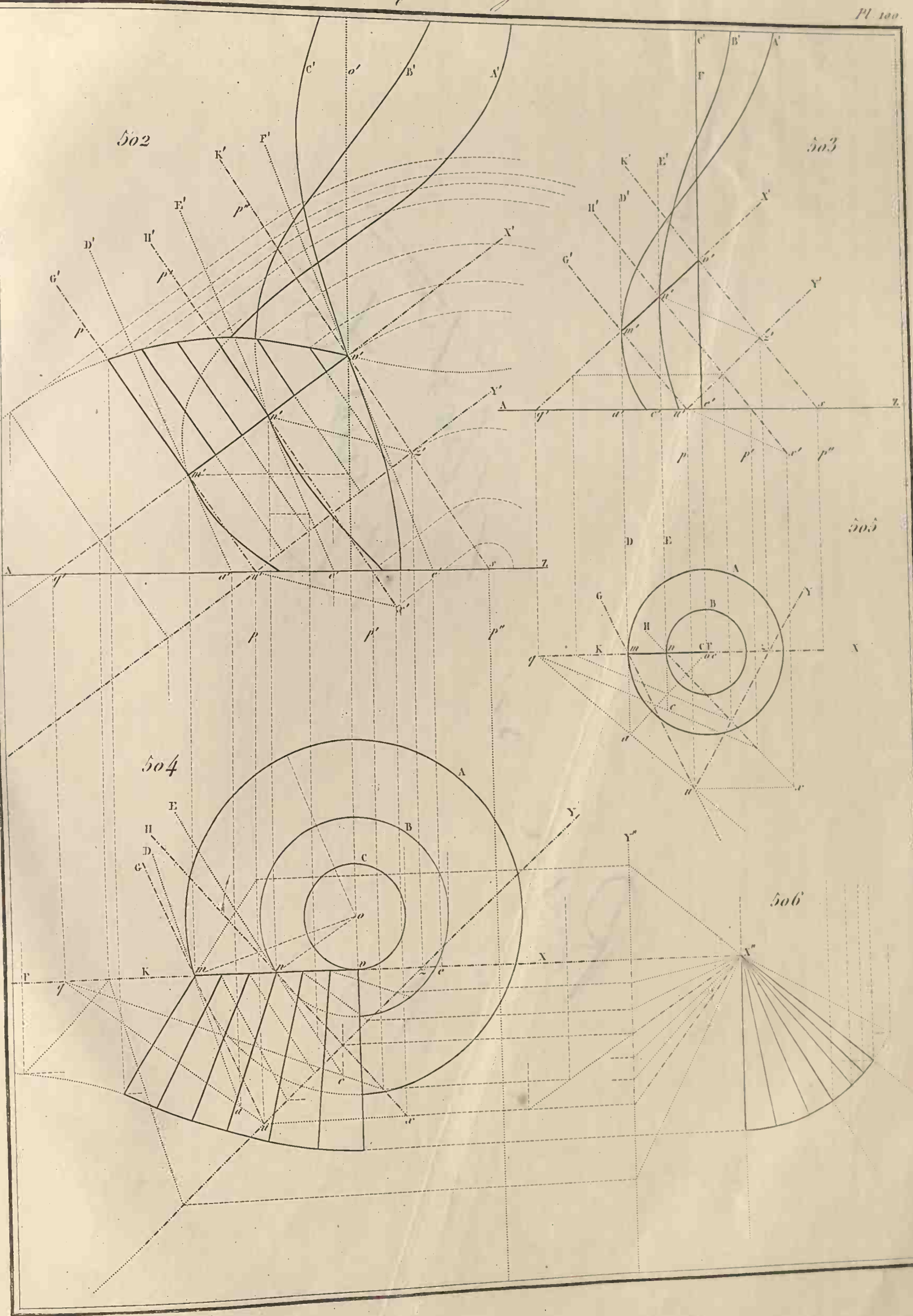

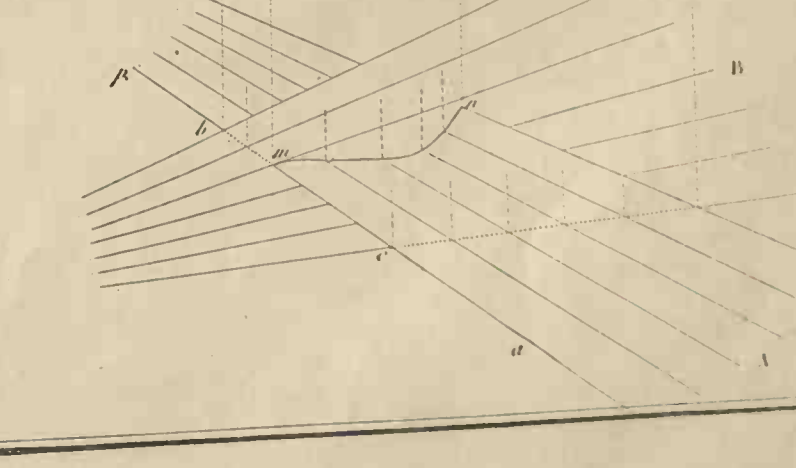
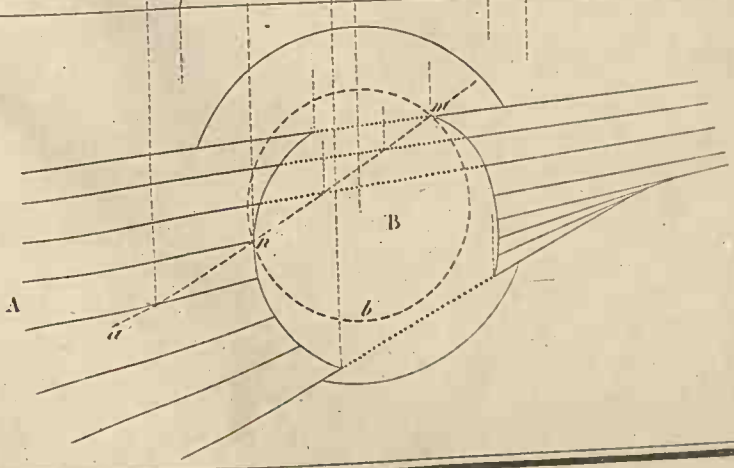
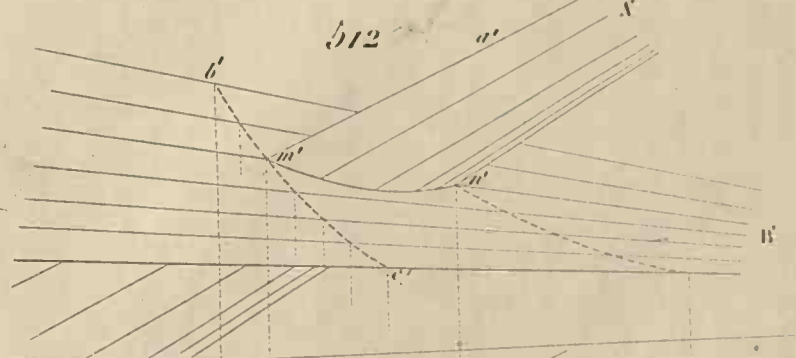
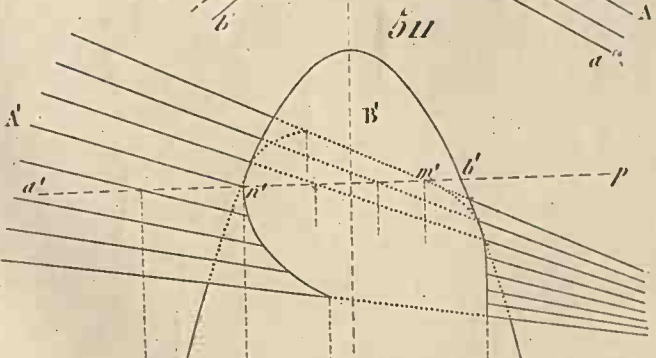
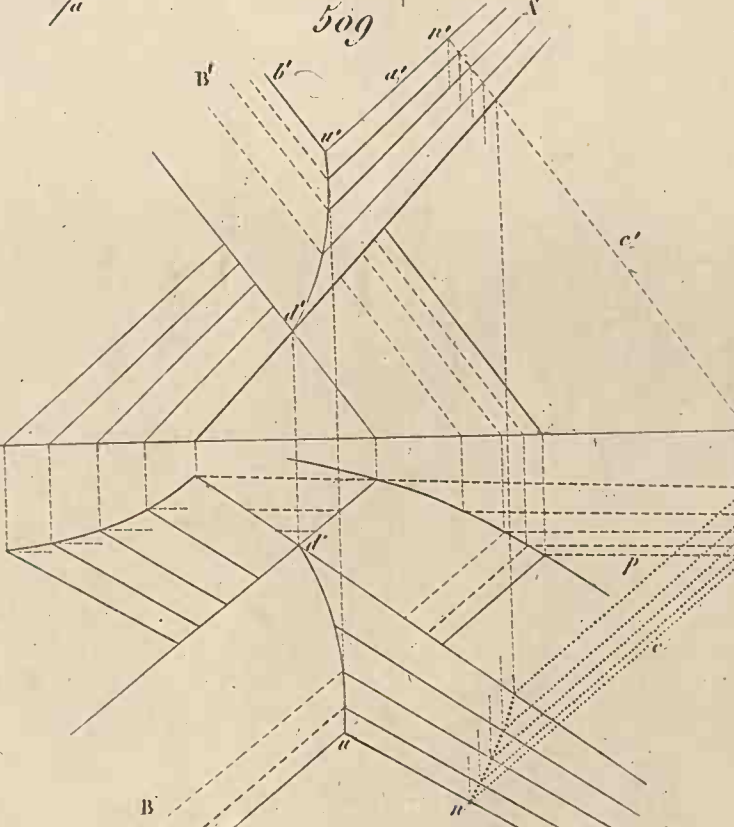
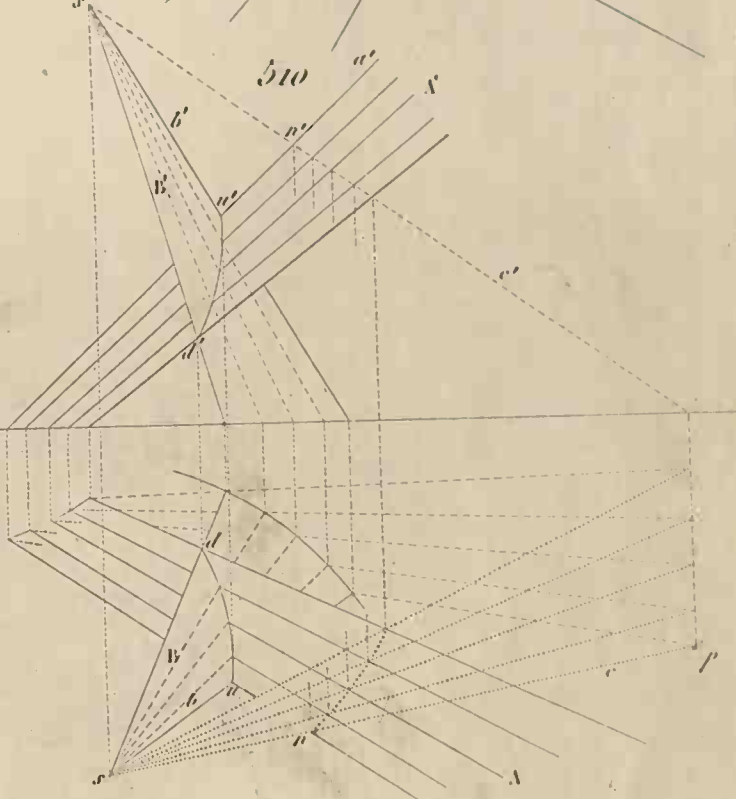
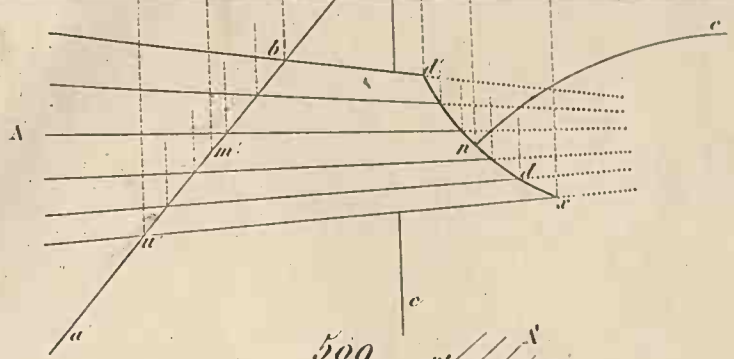
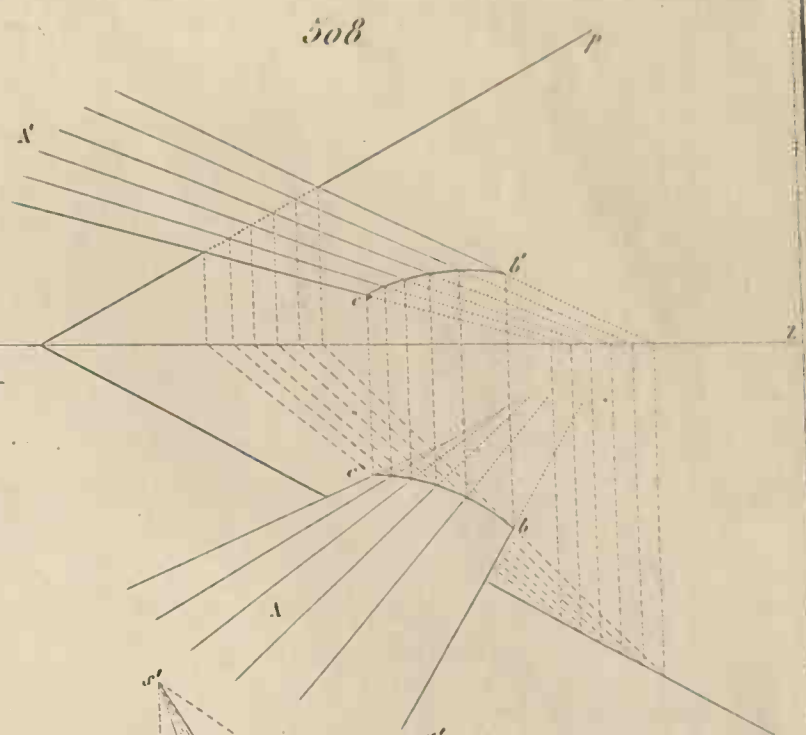
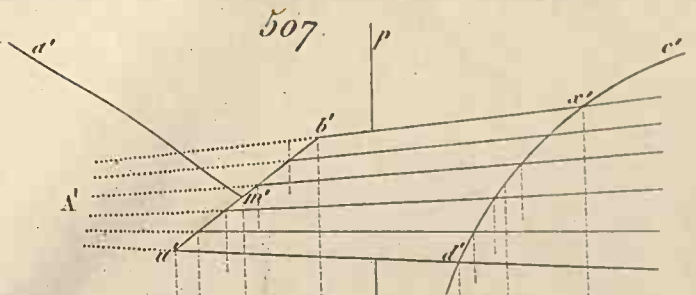

513

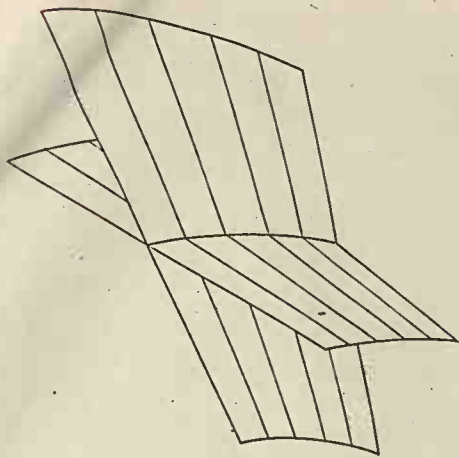

514

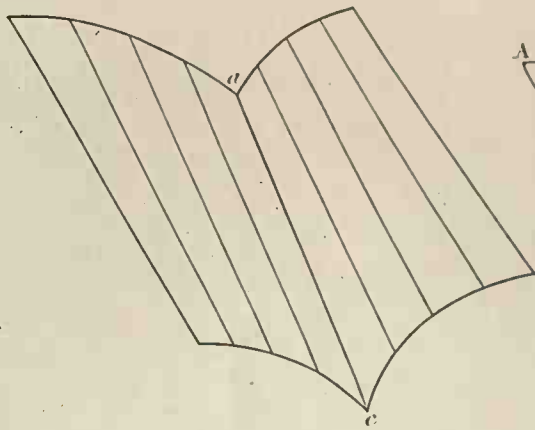

515

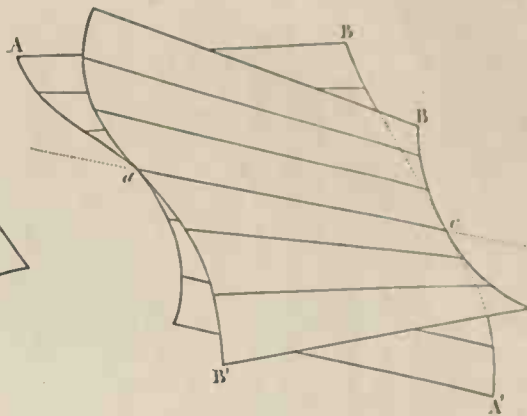

516

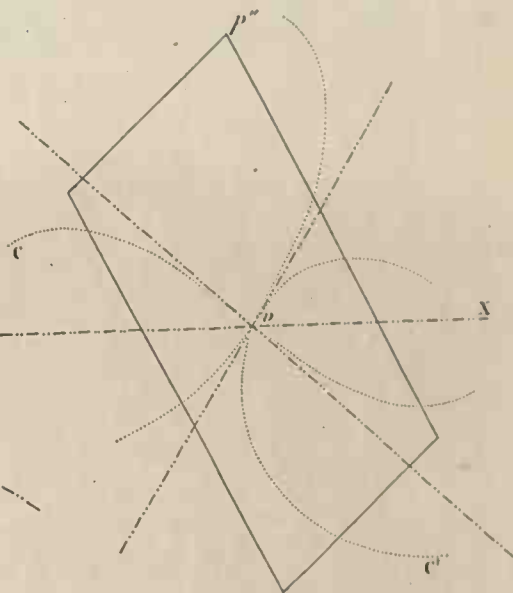
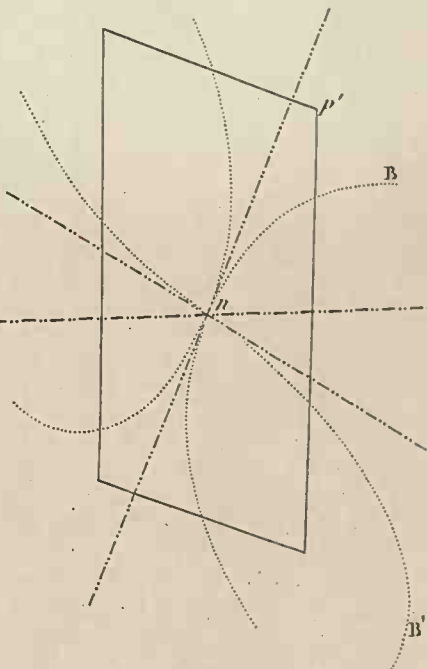
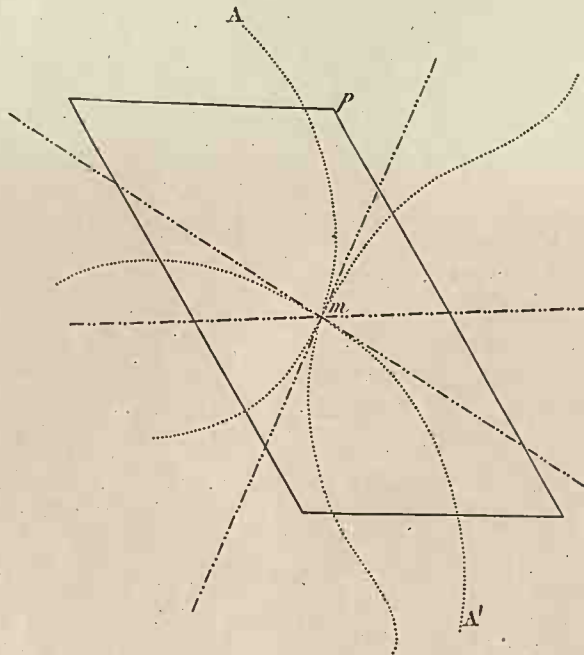

517

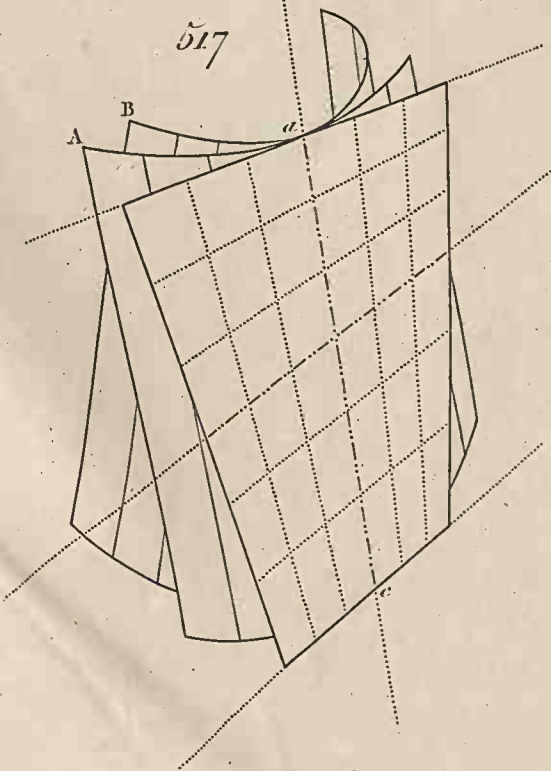

518

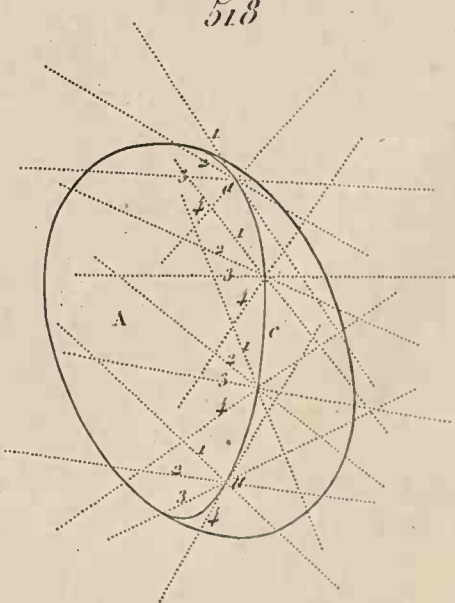

519

