

~~In. A. 35.1117~~

IV. 18651

COURS

DE

MATHÉMATIQUES

A L'USAGE

163450

328 179

DES ARCHITECTES, INGÉNIEURS CIVILS, ETC.

Amal

PAR J. ADHÉMAR

APPLICATIONS DE GÉOMÉTRIE DESCRIPTIVE

CHARPENTES



24586

Quatrième édition

PARIS

ARMAND COLIN ET C^{IE}, ÉDITEURS

16, RUE DE CONDÉ, 16

1875

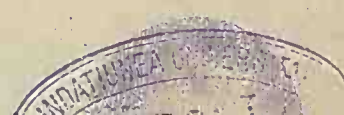
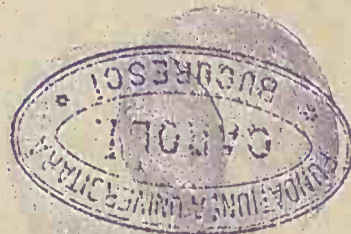

C/953

1961

L

1956

BIBLIOTECA ȘTIINȚILOR UNIVERSITARE
BUCUREȘTI
Cota 18651
Inventar 24556

RC115/06

B.C.U. Bucuresti

C24556

BIBLIOTECA
ȘTIINȚILOR UNIVERSITARE
BUCUREȘTI

Projections

Pl. I.

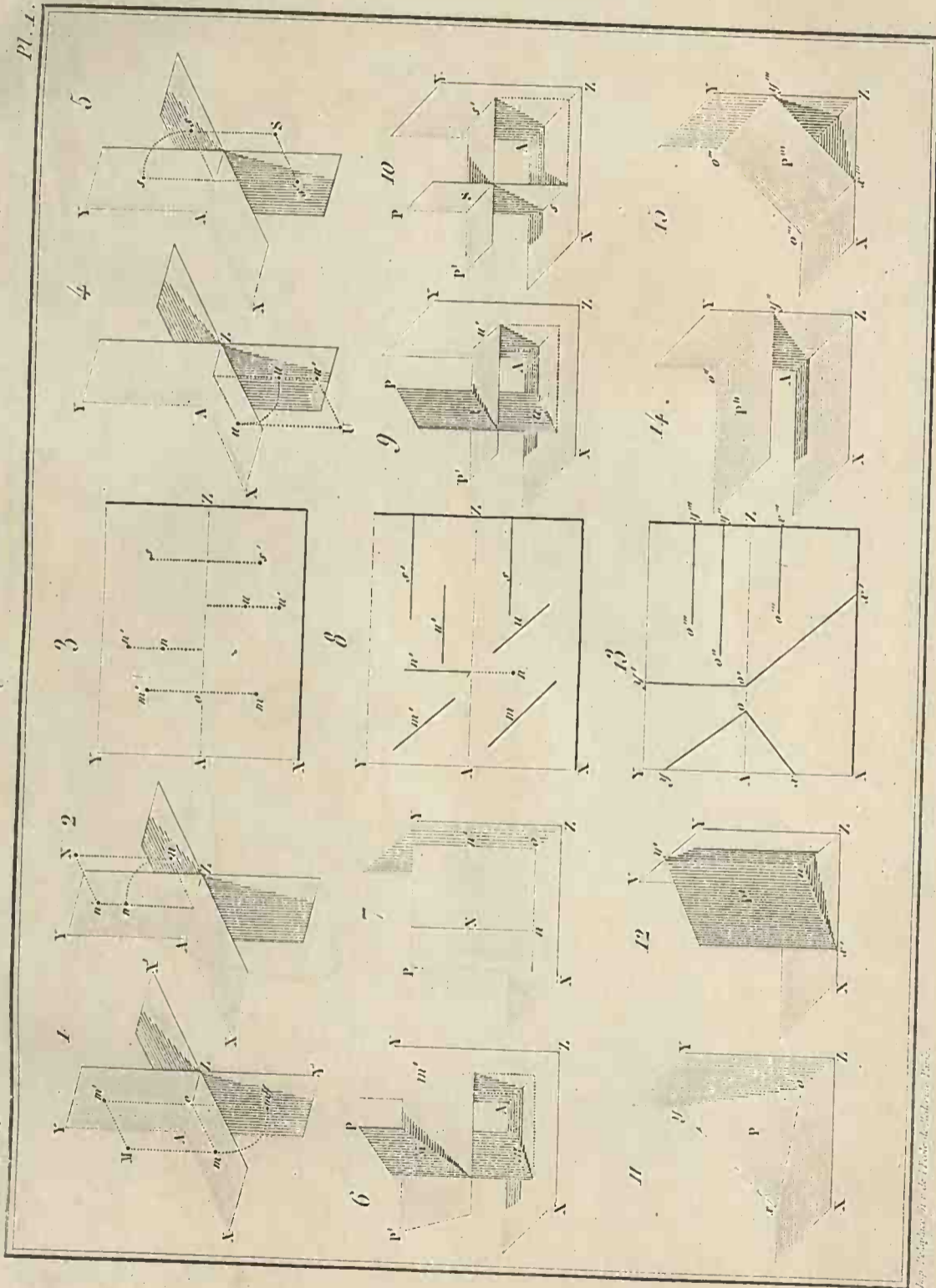
Introduction



L'ap. de l'art de l'ingénieur.

Altkumar del.

Points, lignes droites, plans

Introduction

Pl. 2.

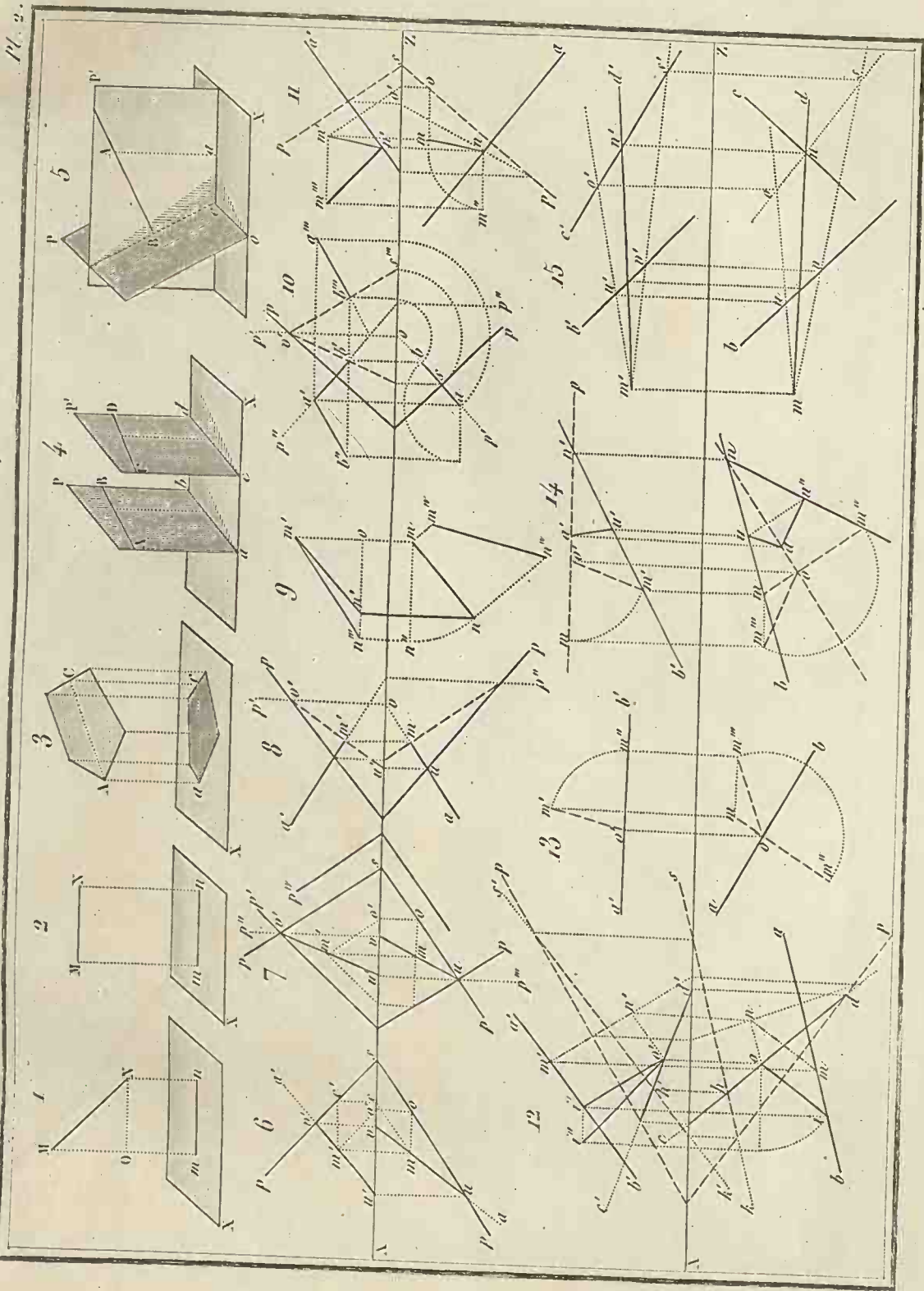

Mémoires del

Angles des droites et des plans

Introduction

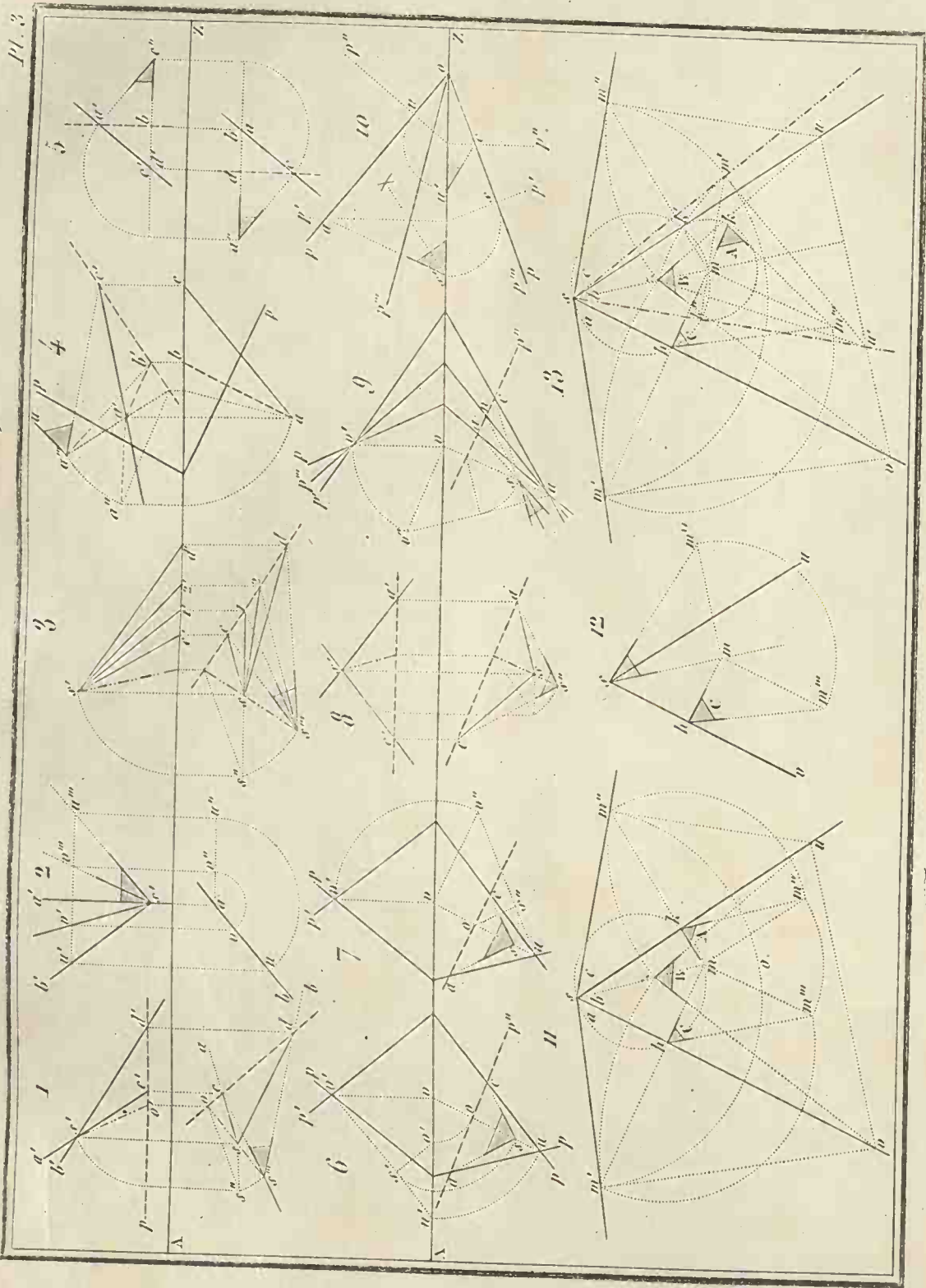

Pl. 3

Blancard del.

Sections et courbes planes.

Introduction

Pl. 4.

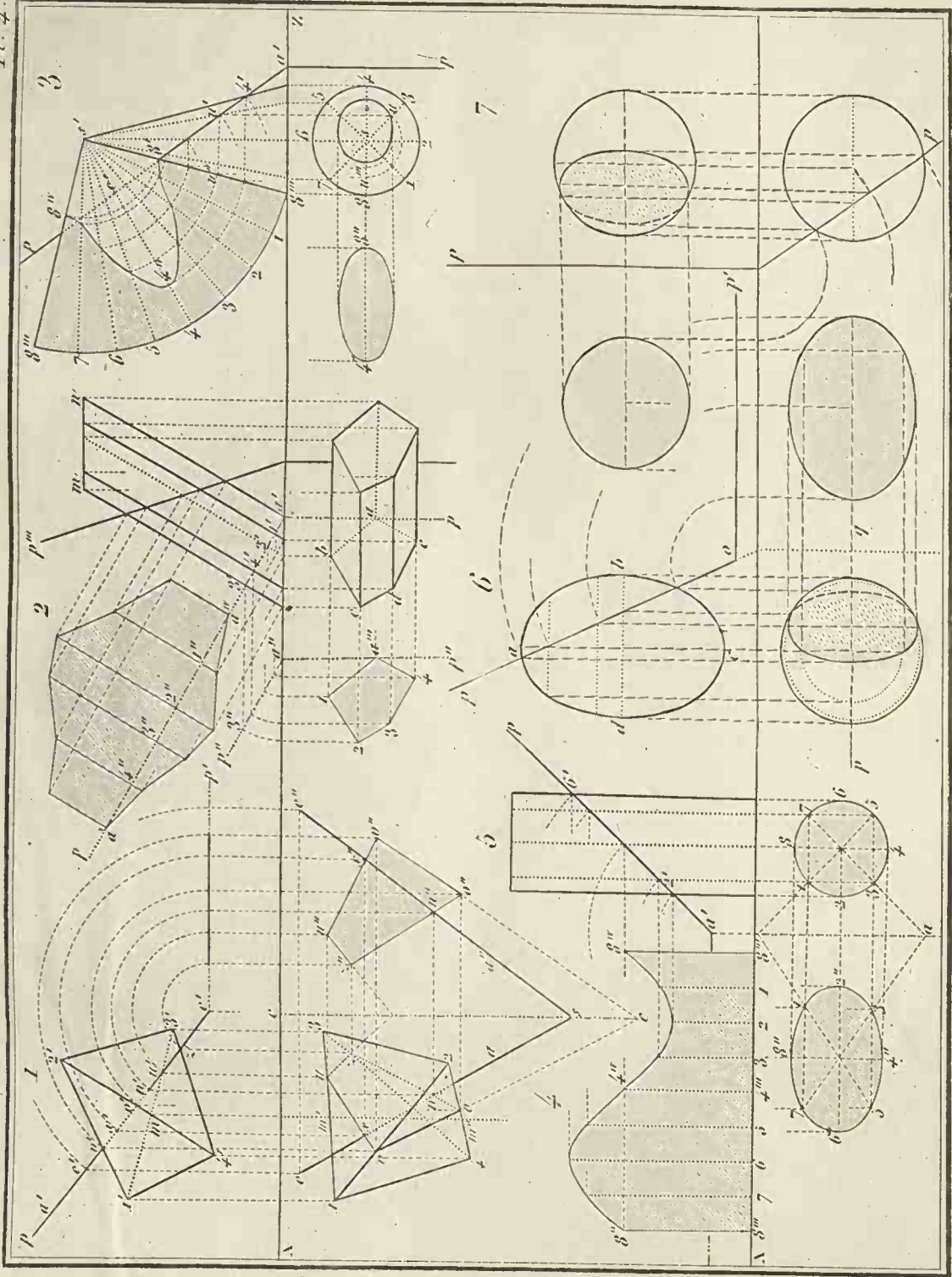

Adhemar de L.

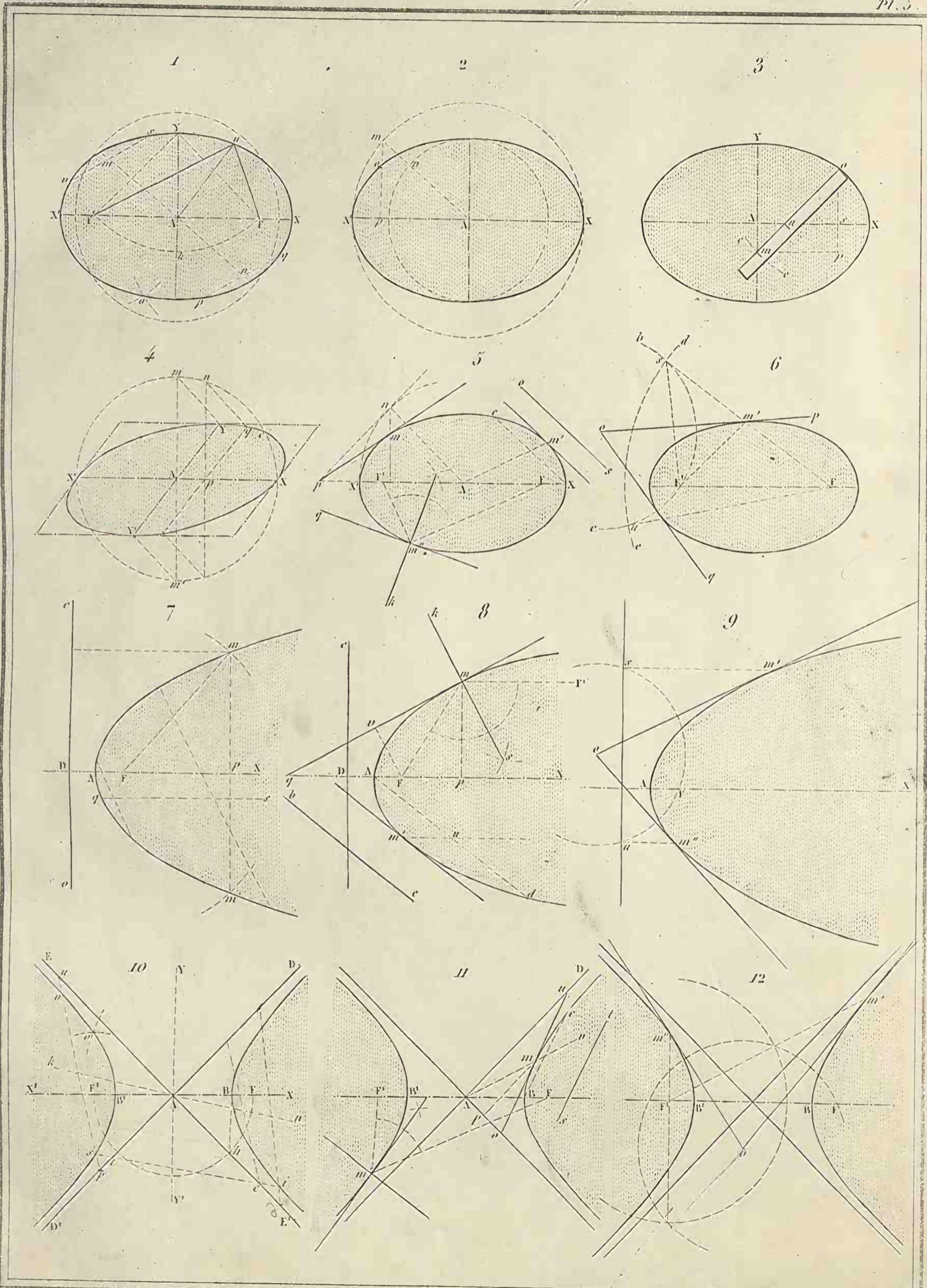

Sections coniques

Introduction

Pl. 6.

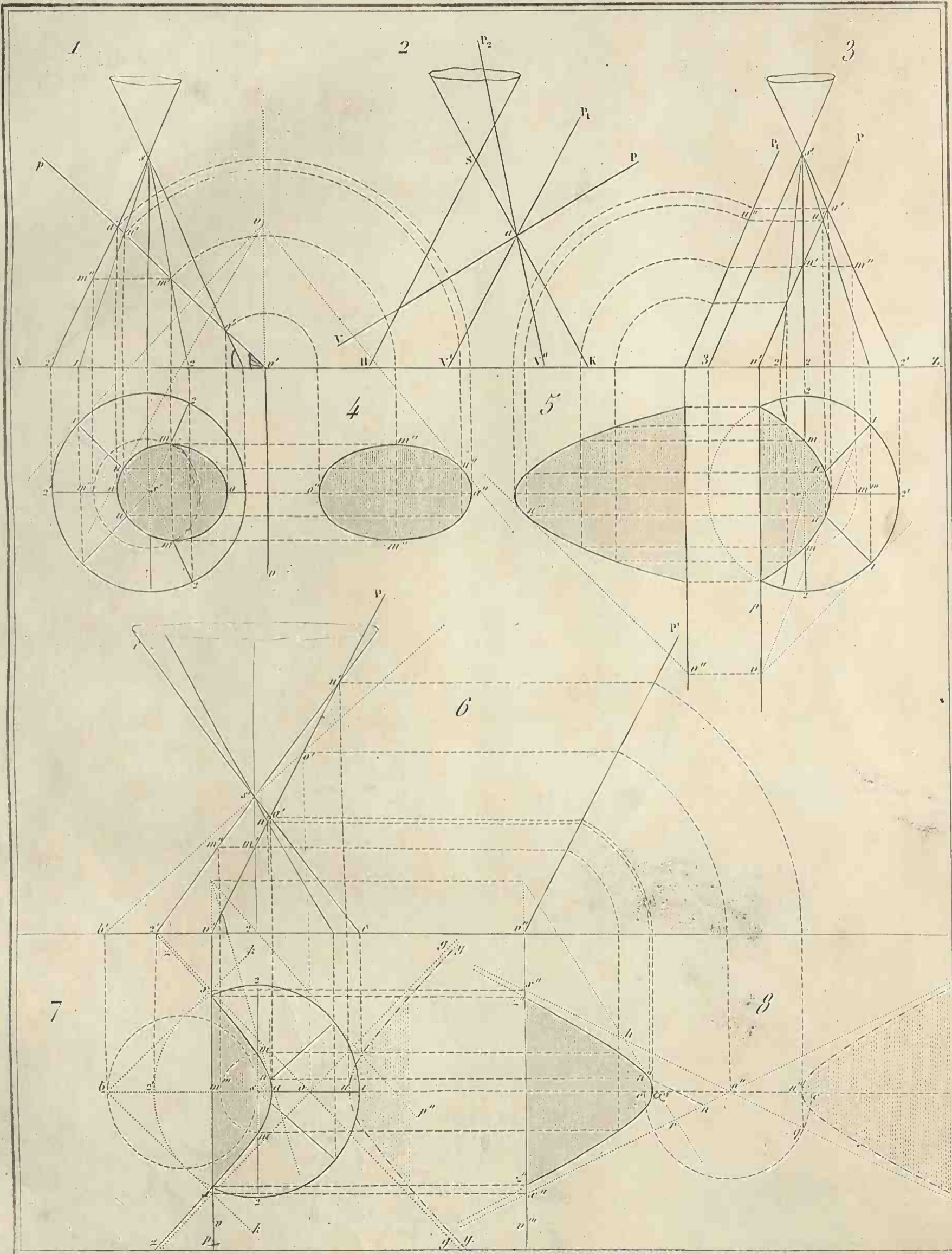

Courbes à double courbure.

Introduction

Pl. 7.

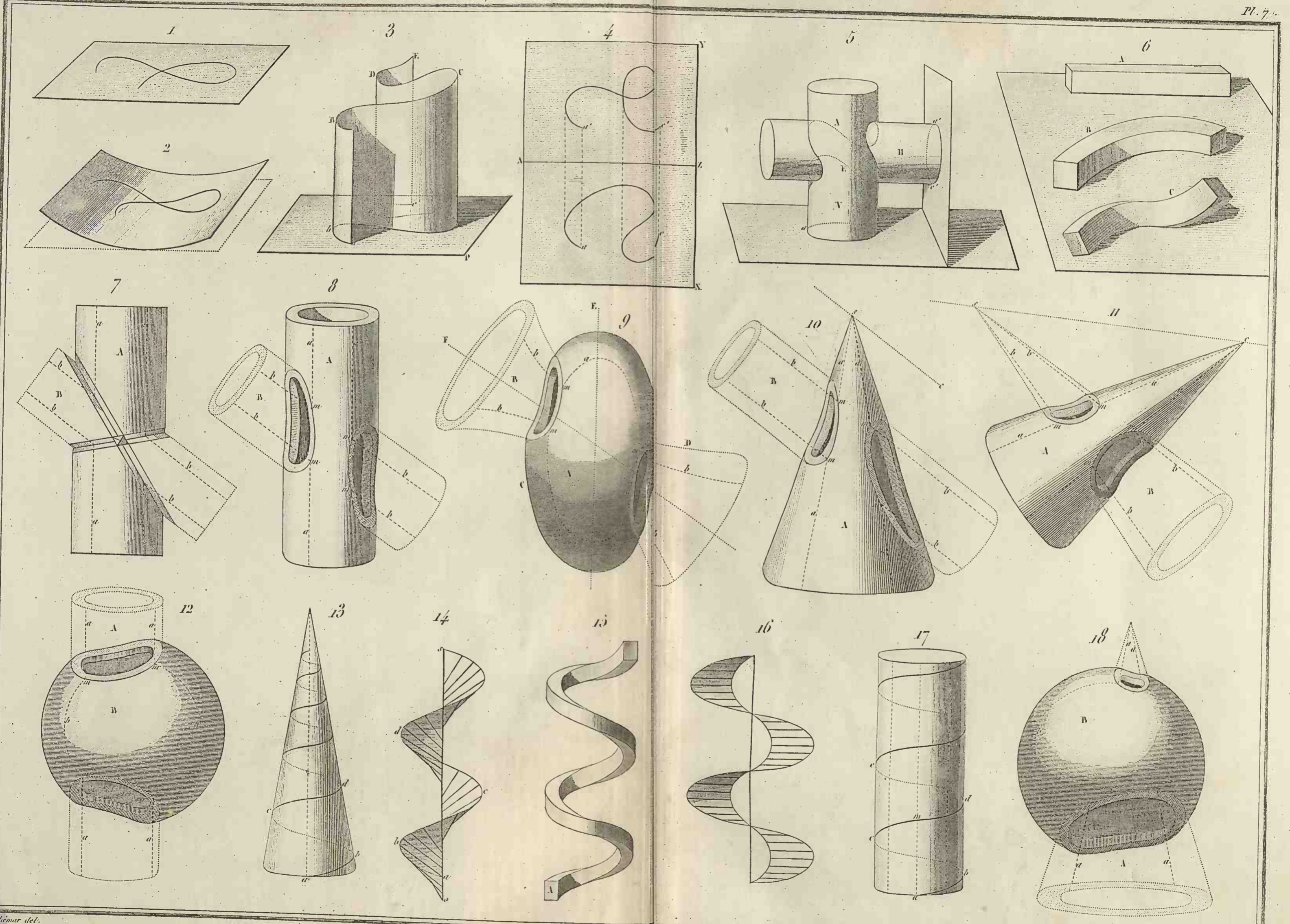

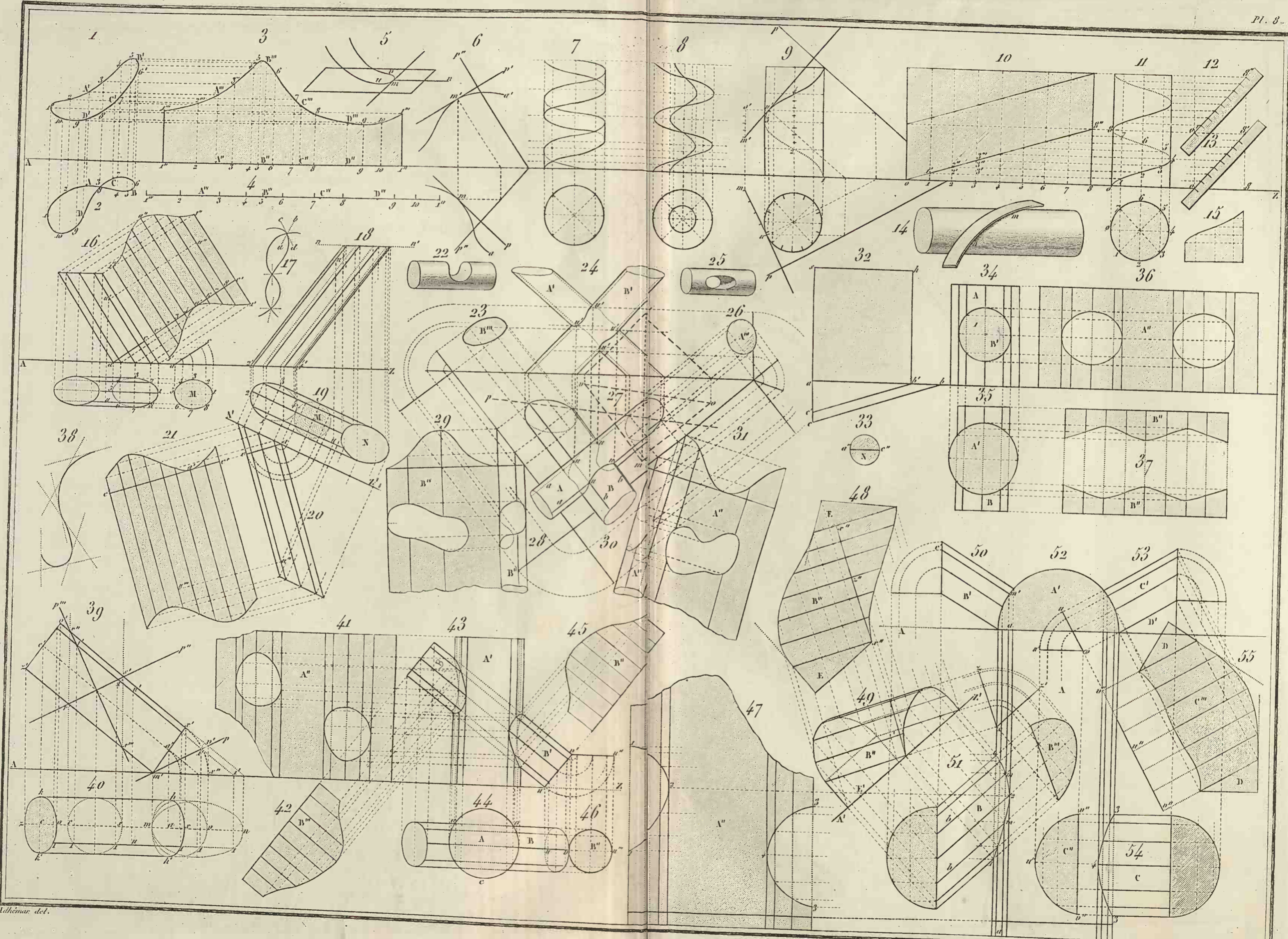

Courbes à double courbure.

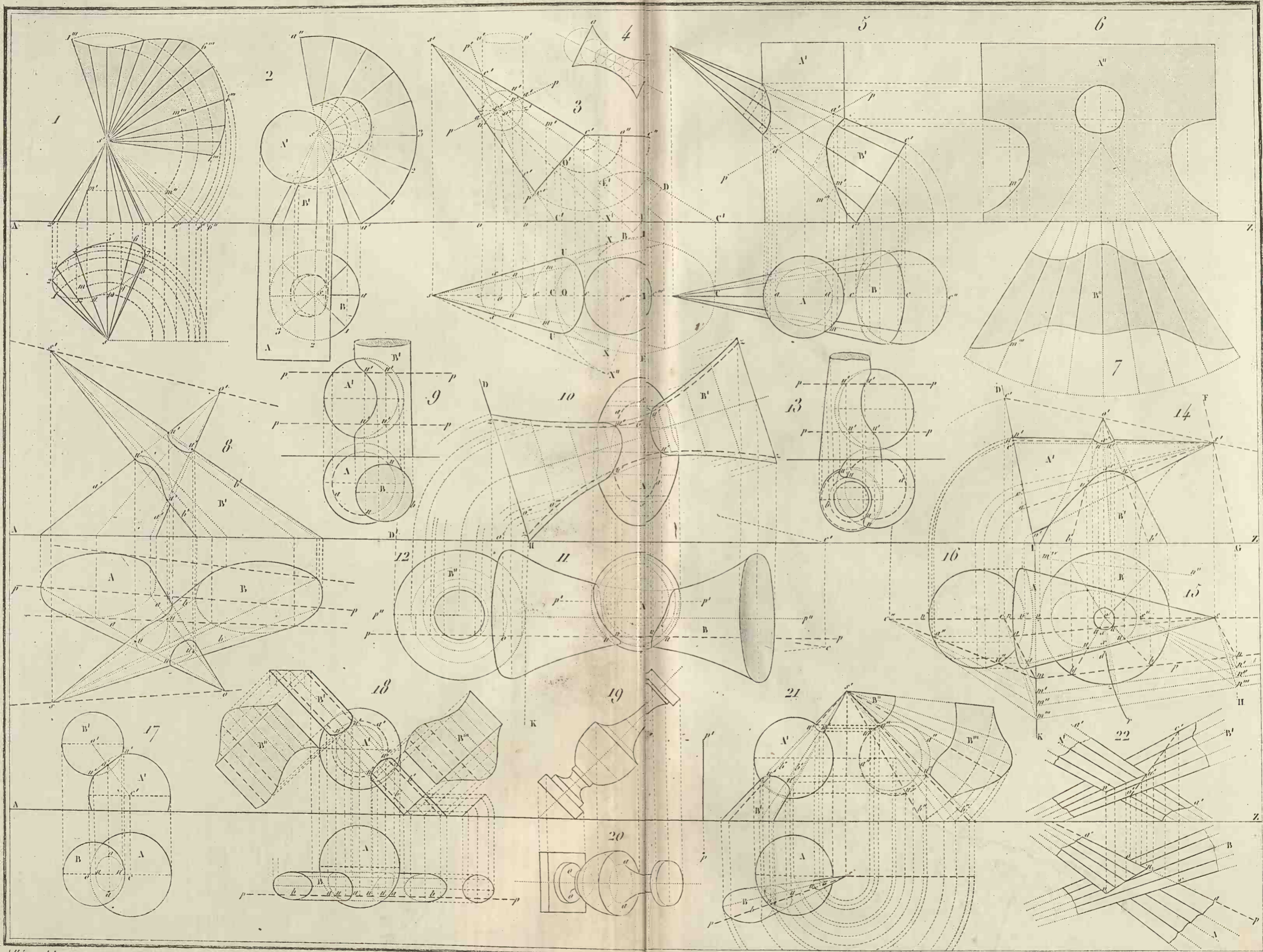

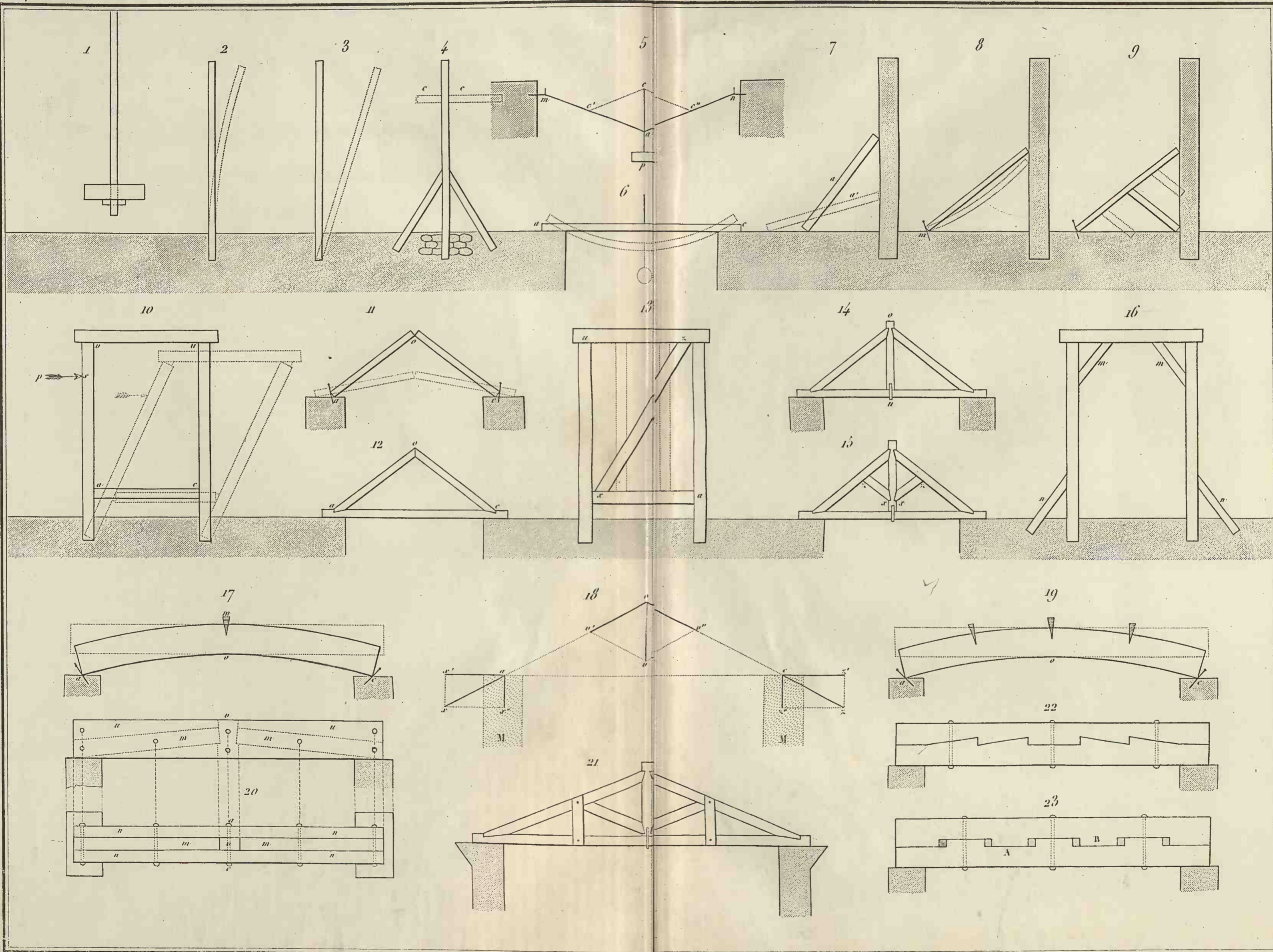

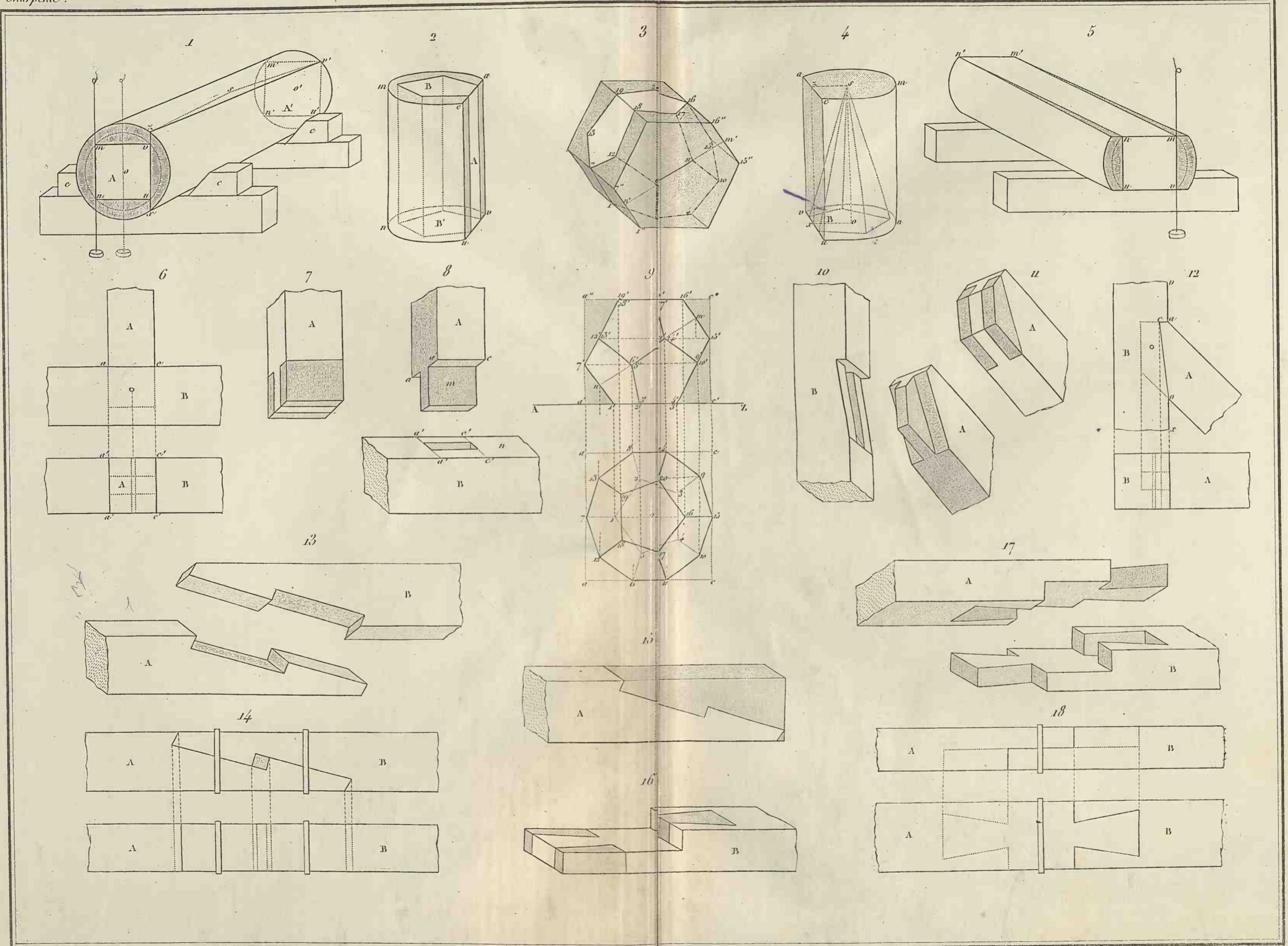

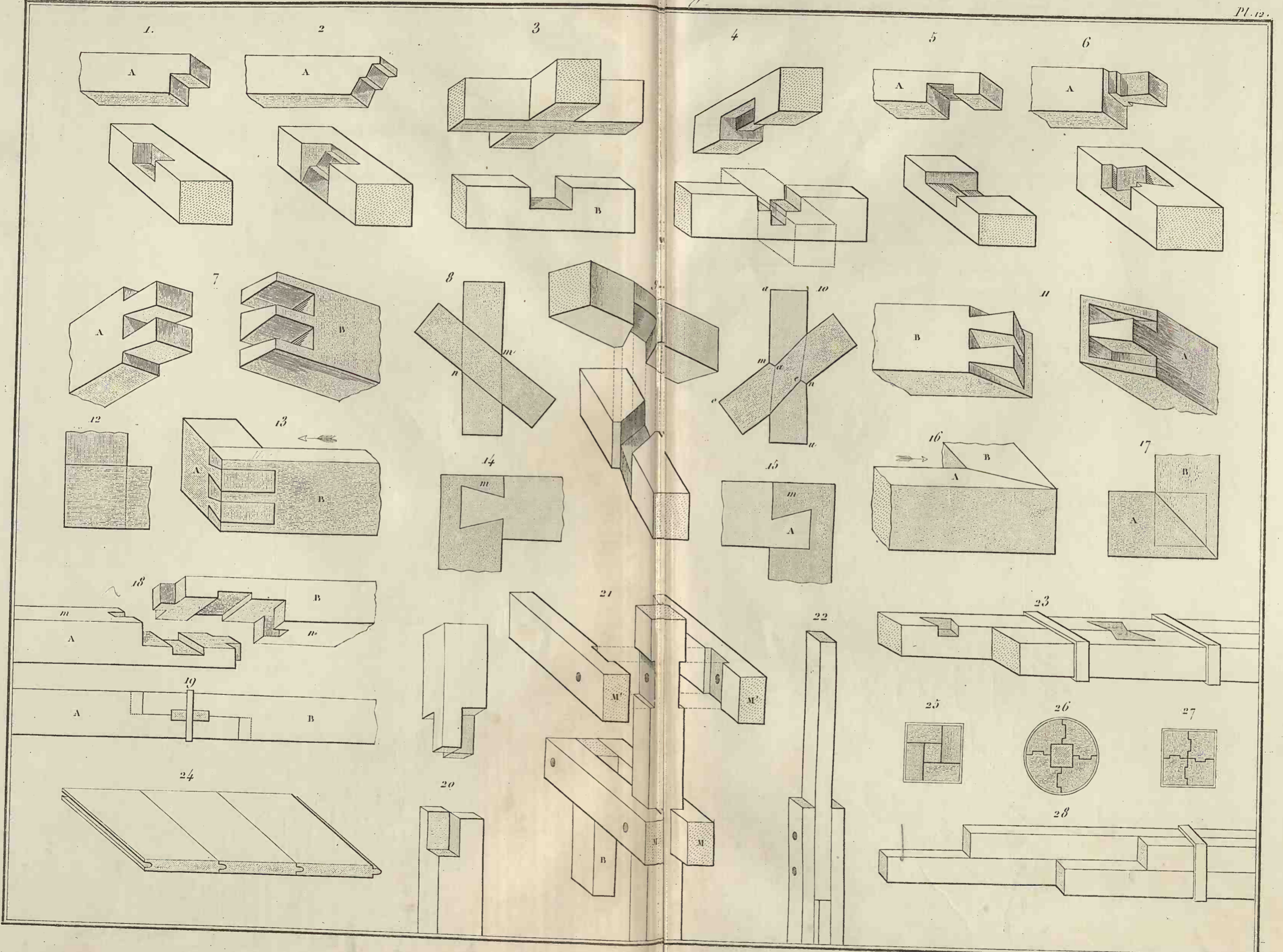

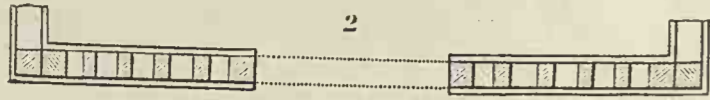

3

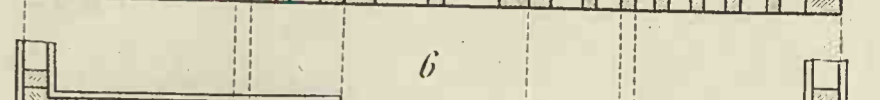
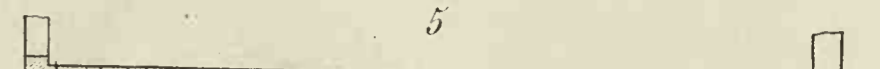
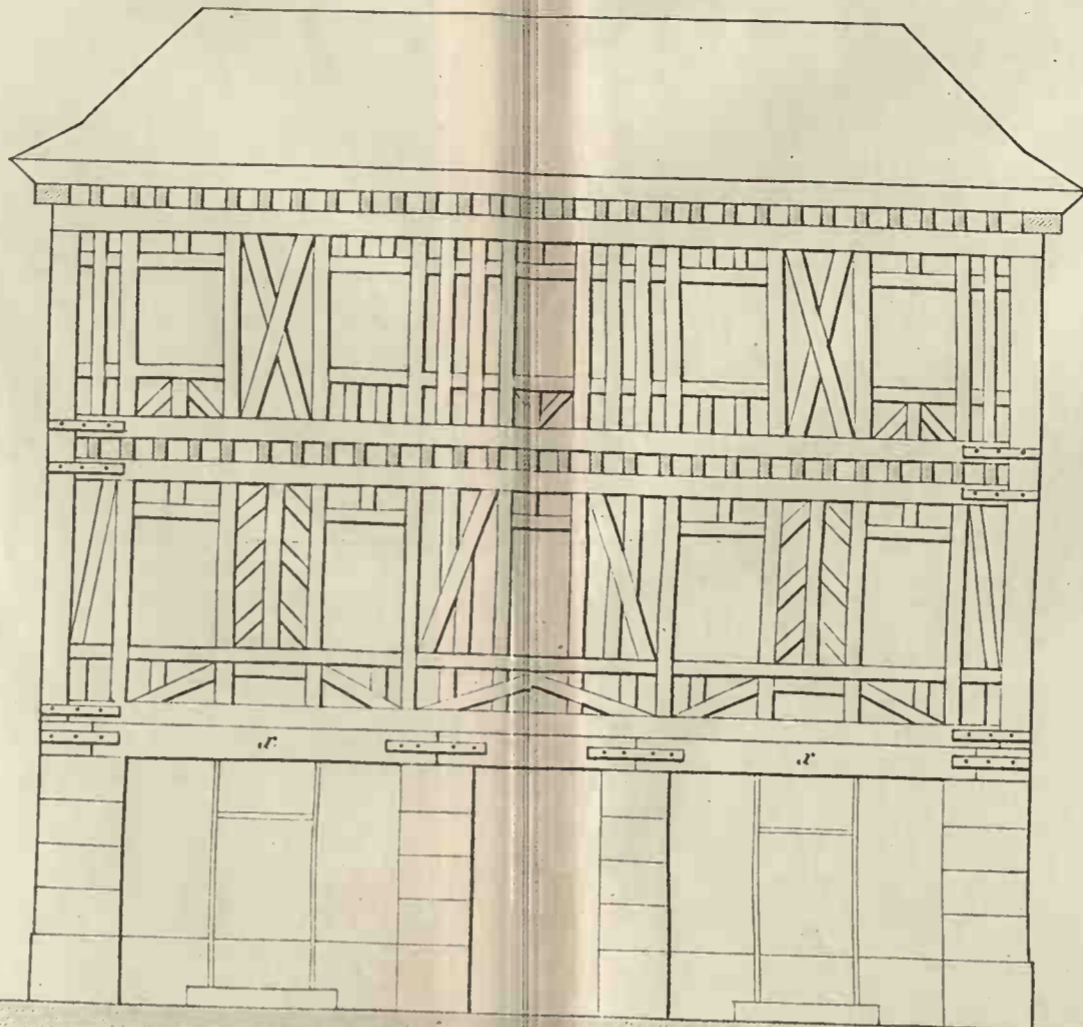
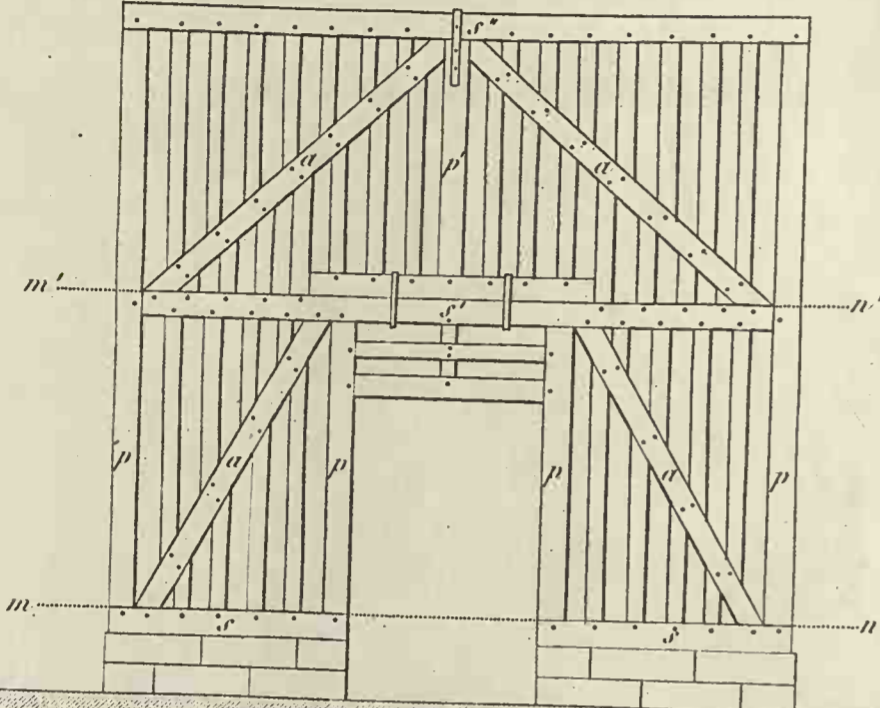

7

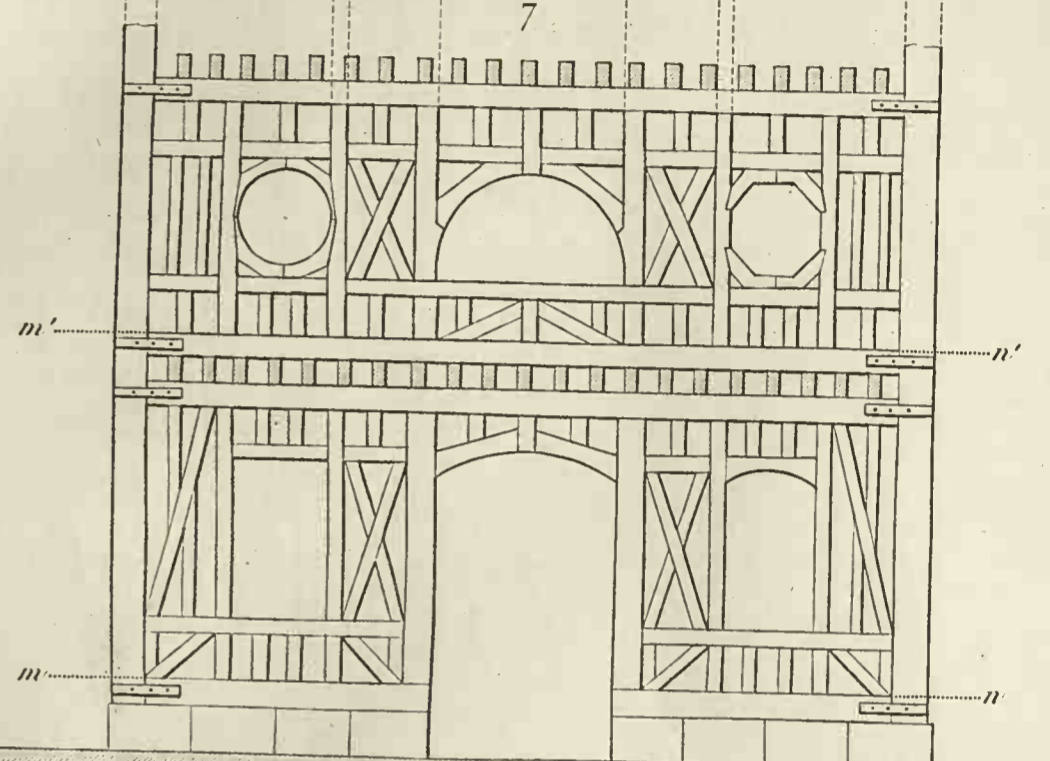

8



9

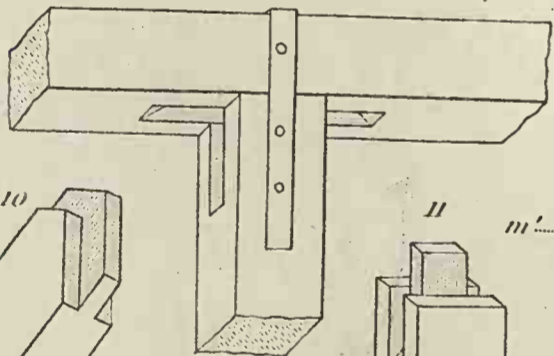

11

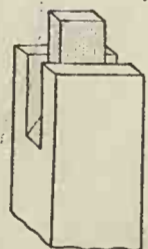

14



13



12

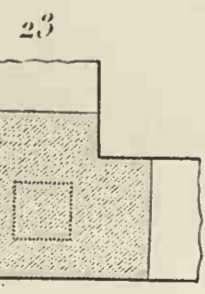
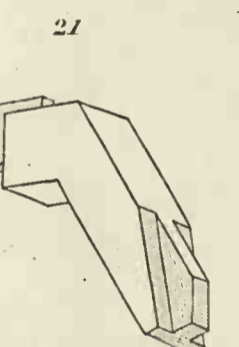
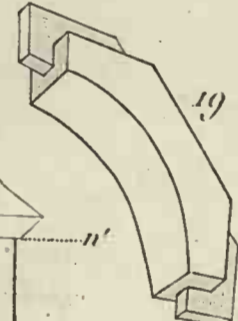
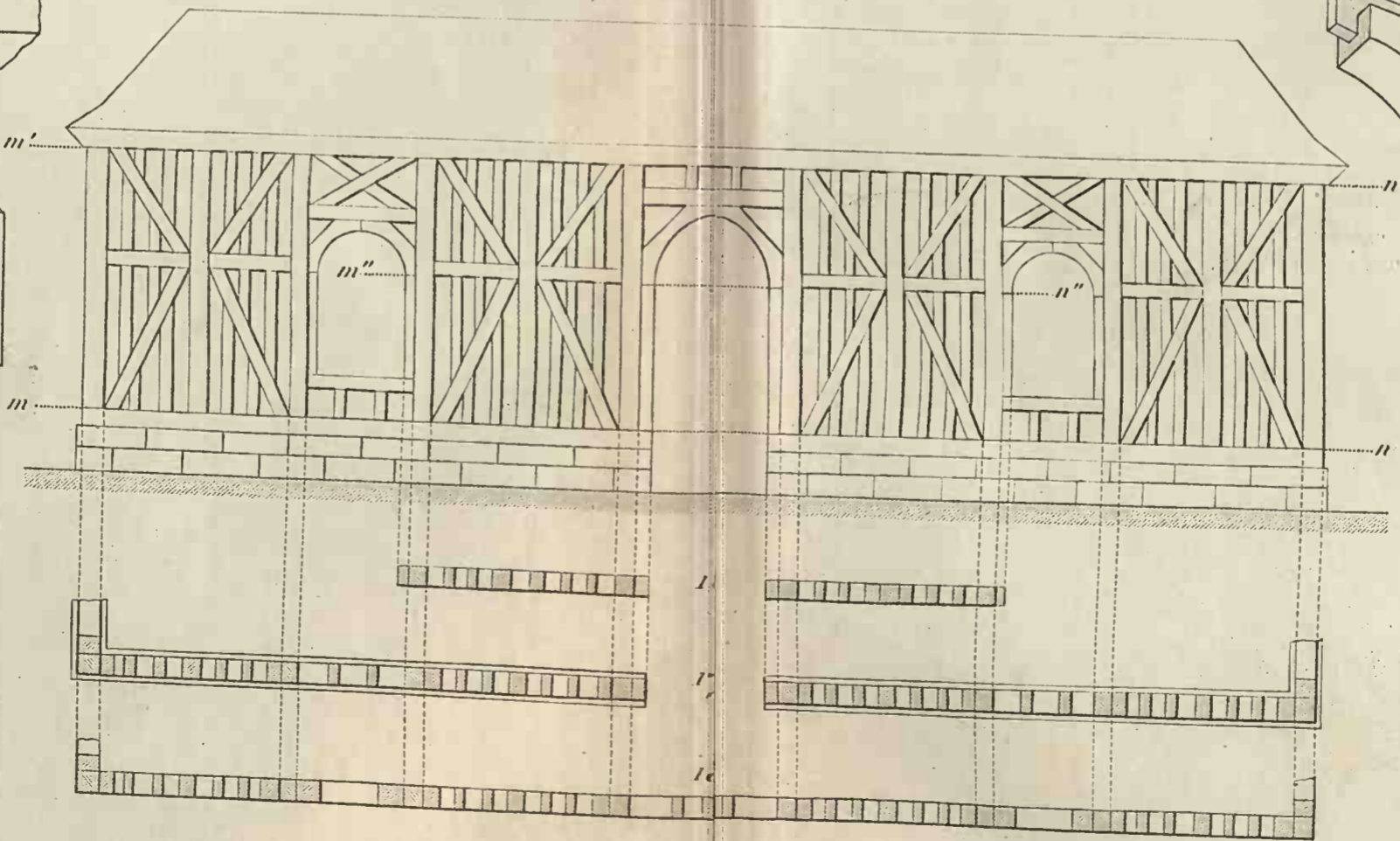

26

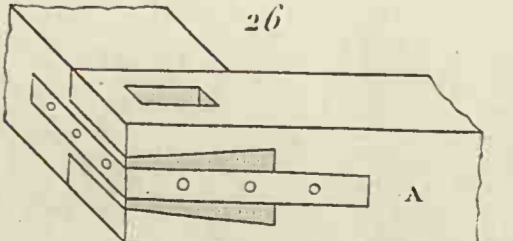

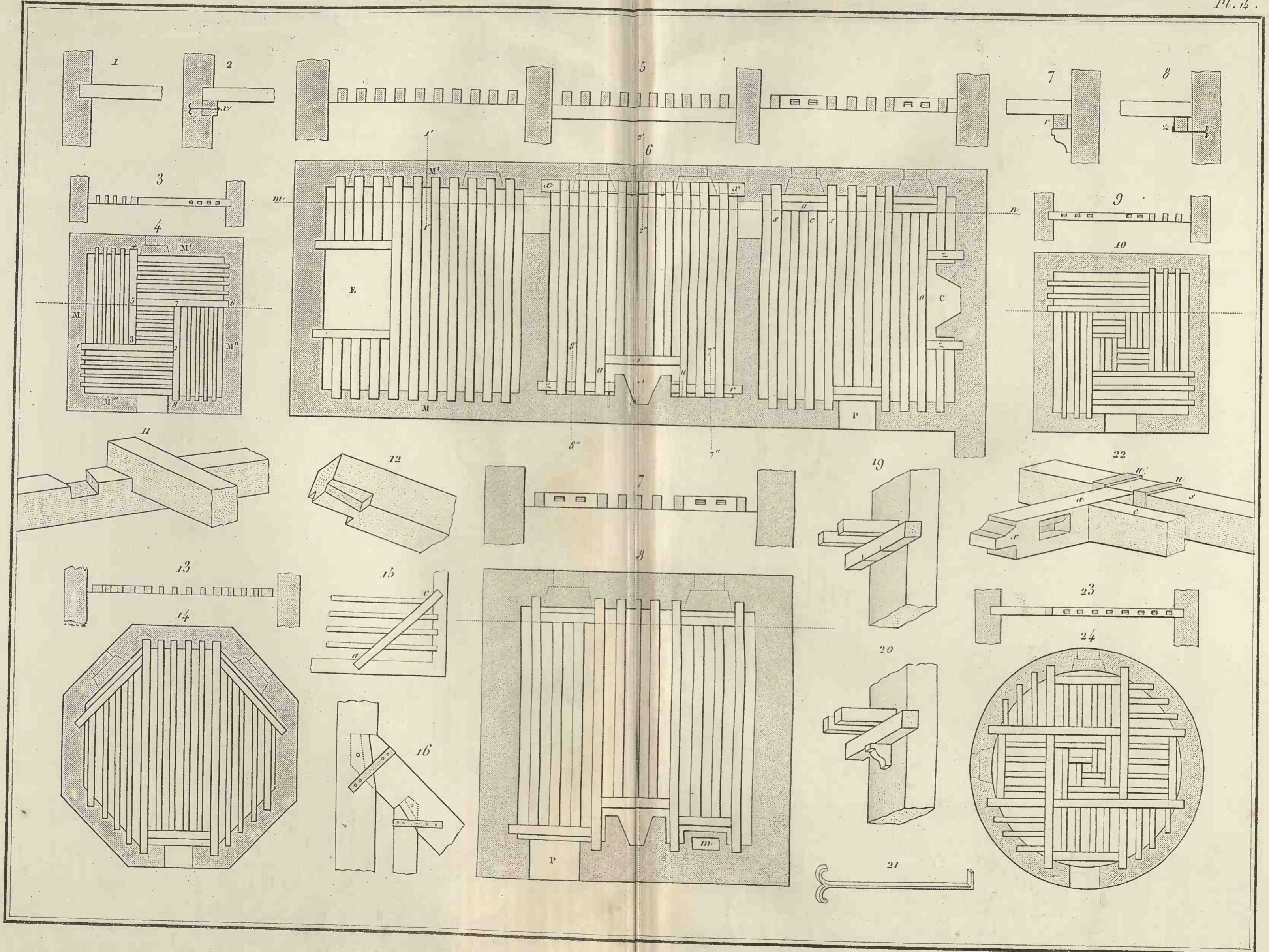

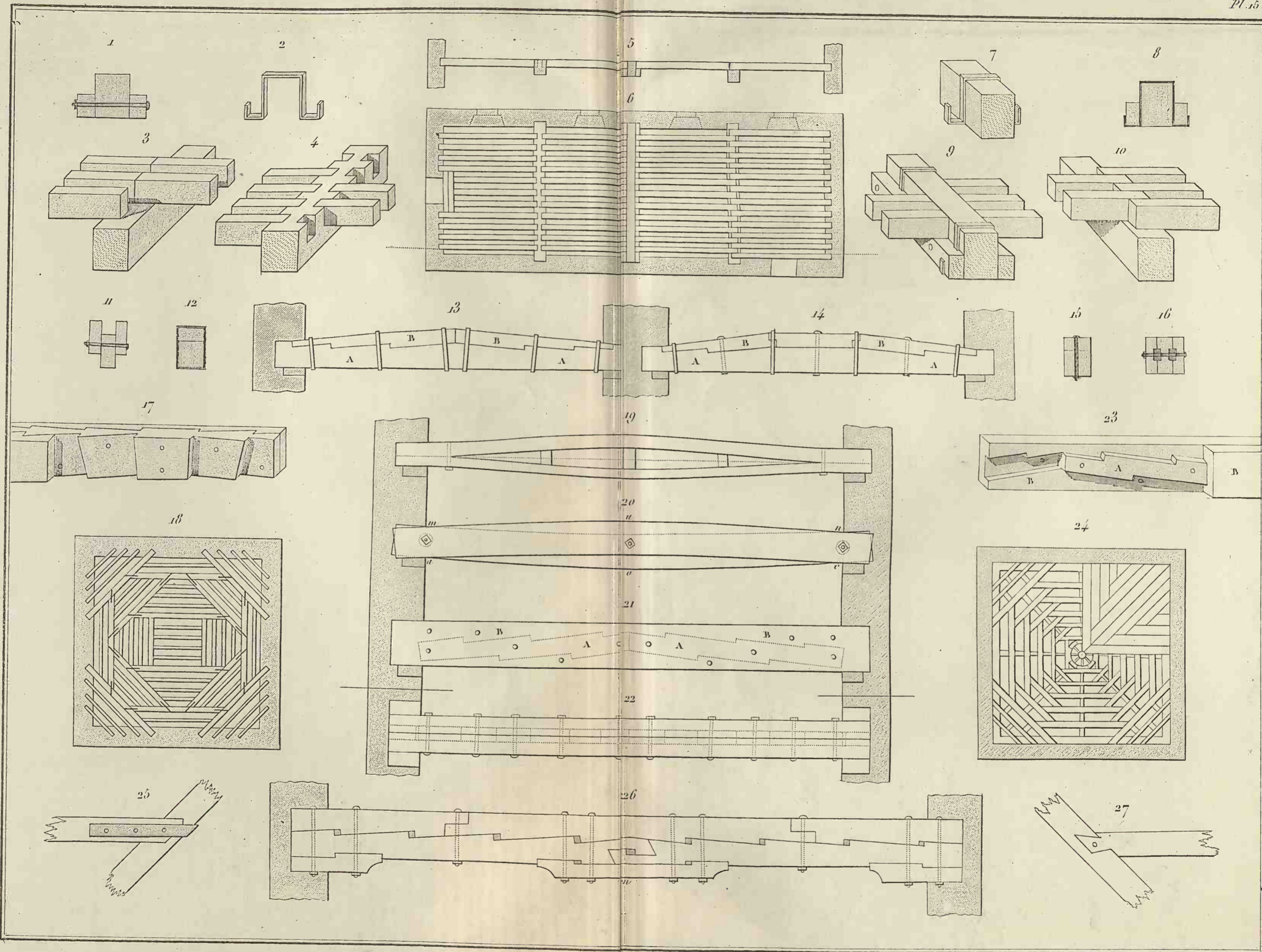

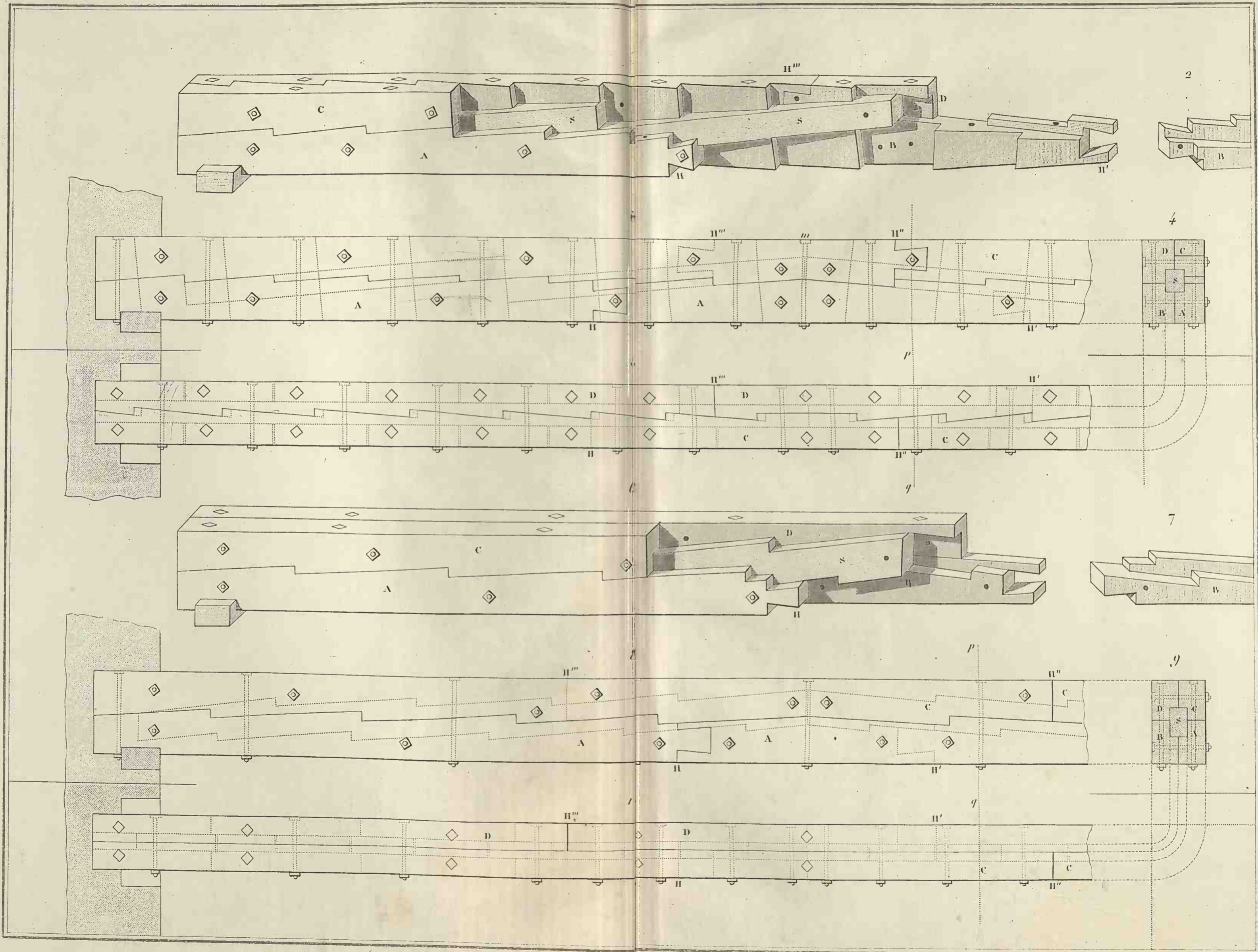

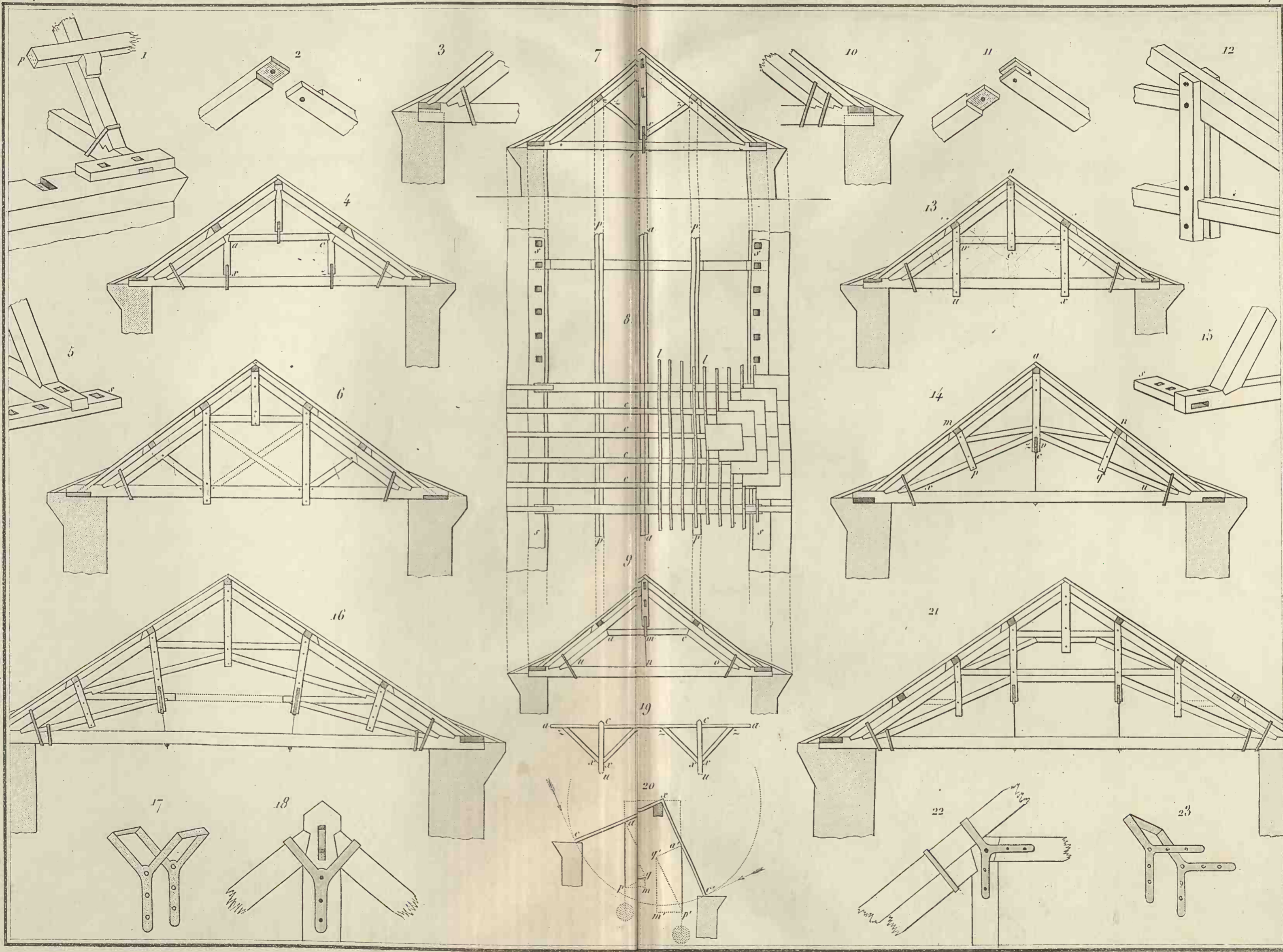

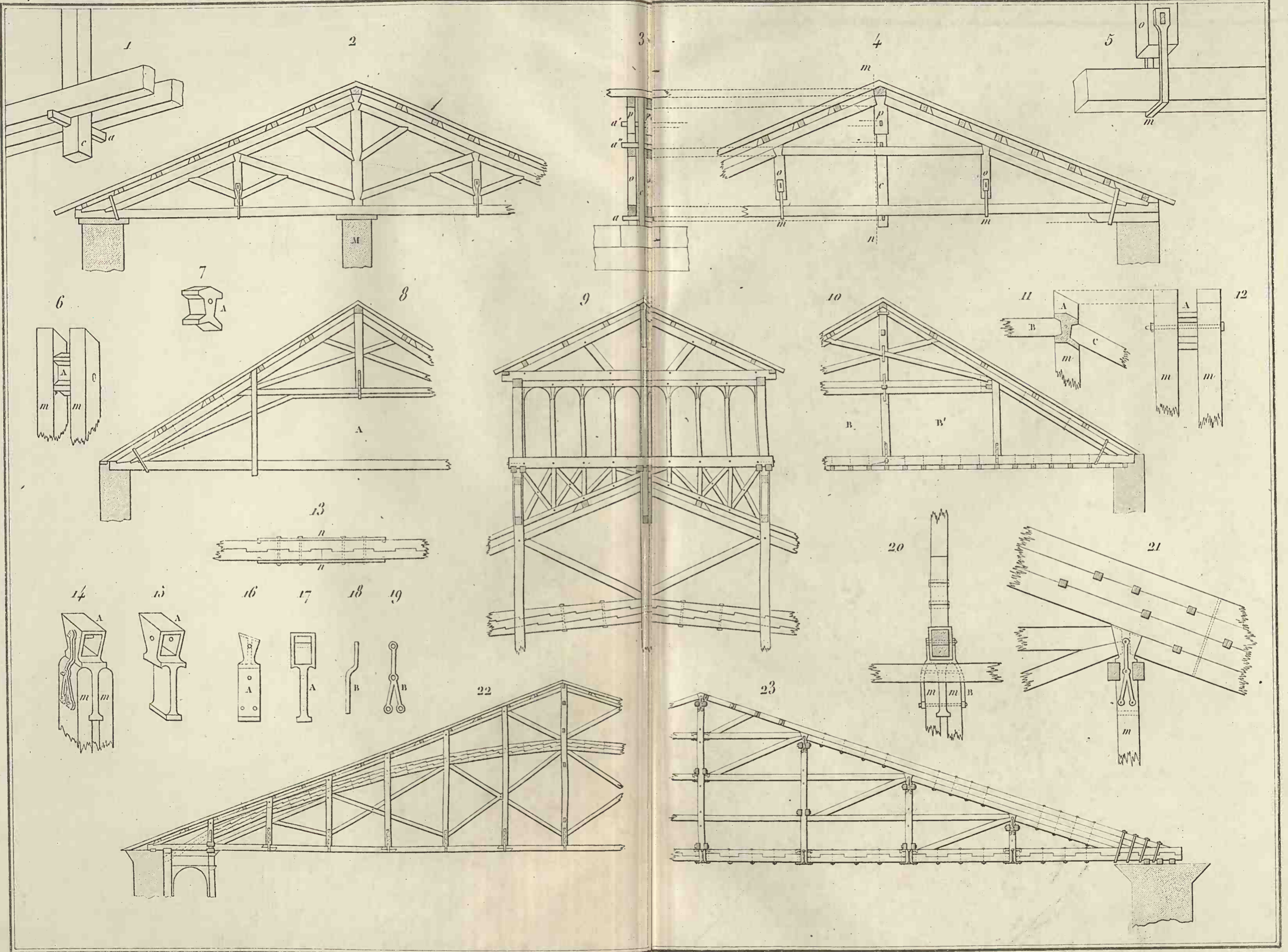

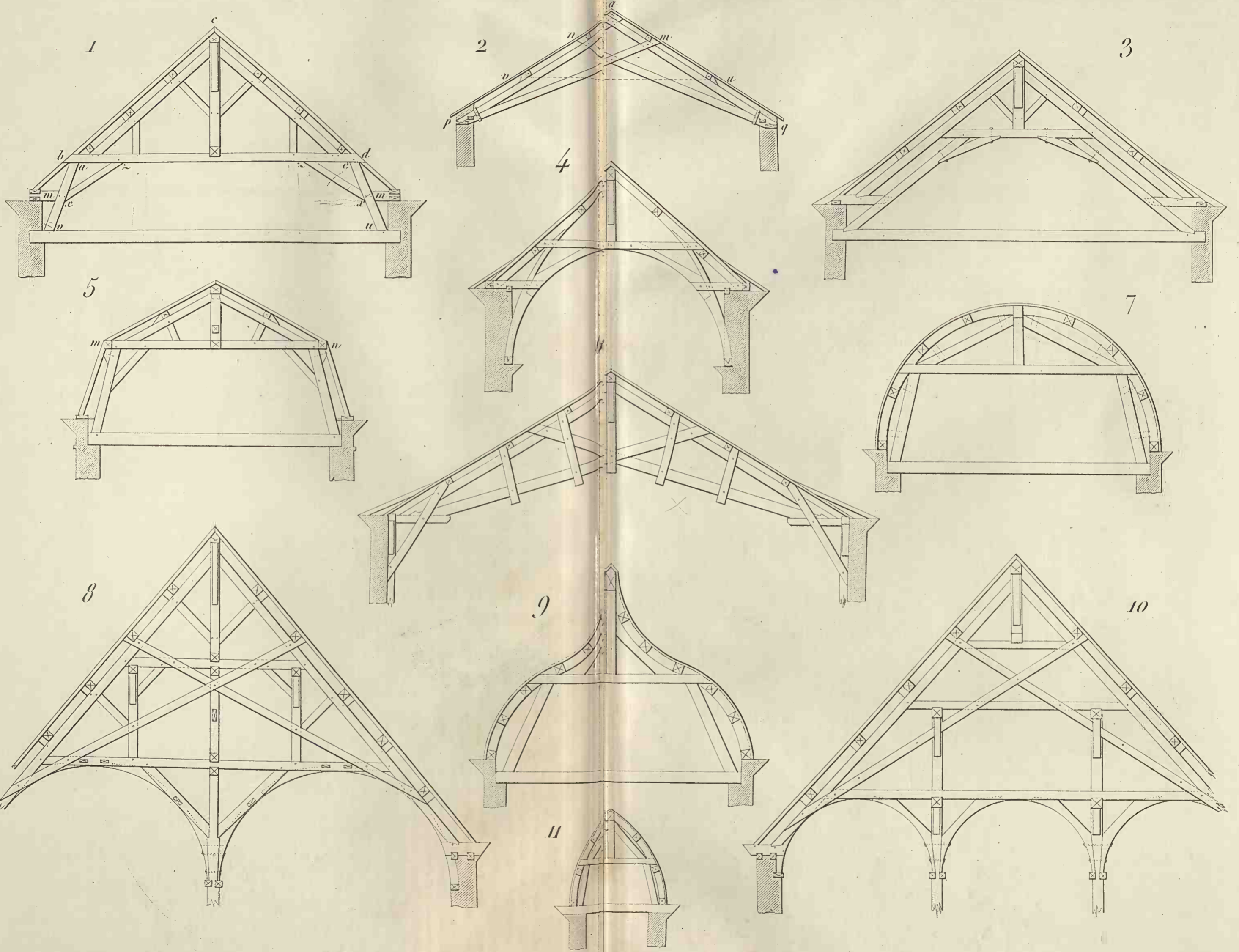

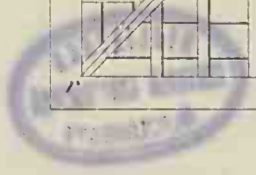
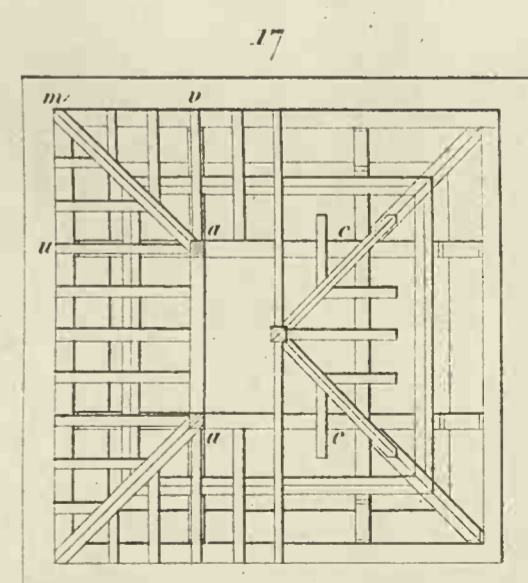
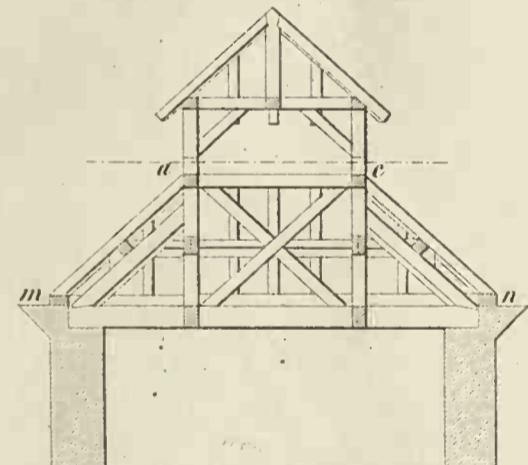
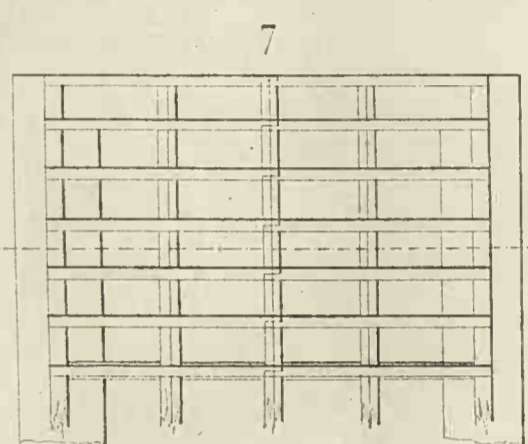
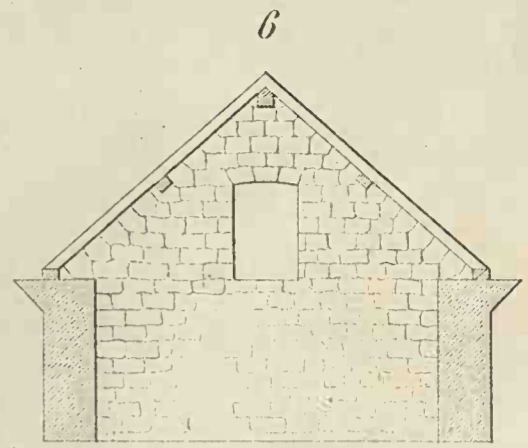
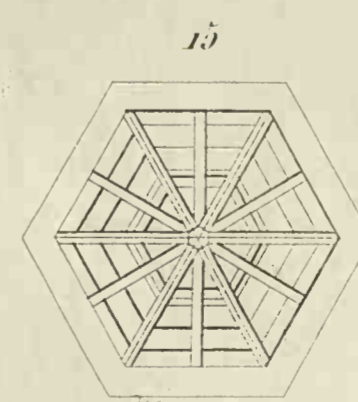
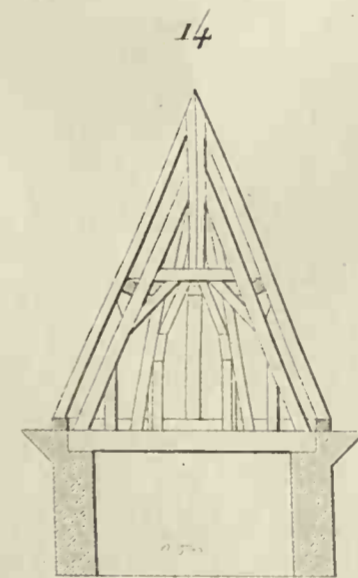
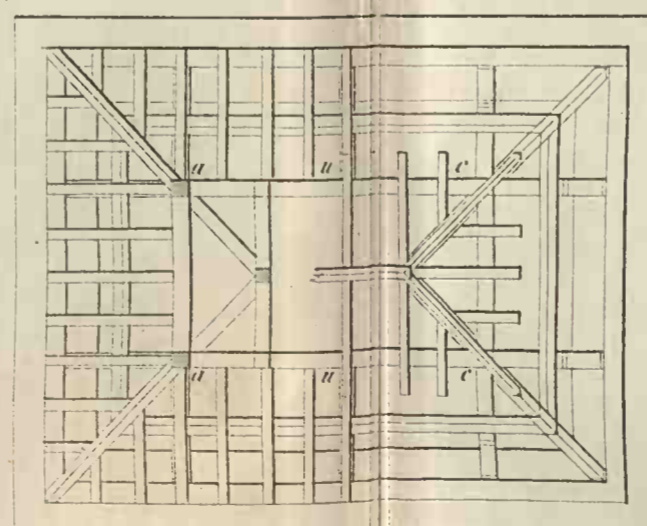
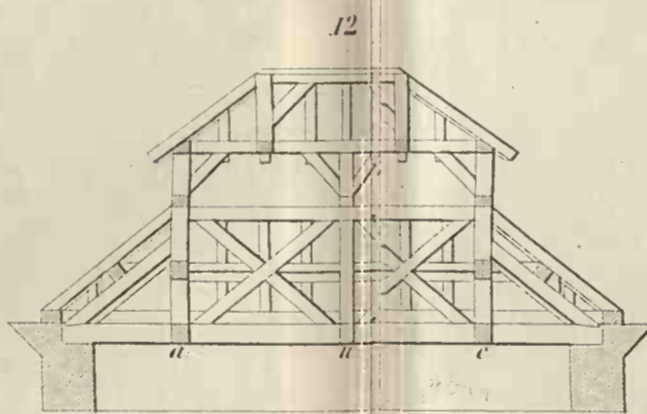
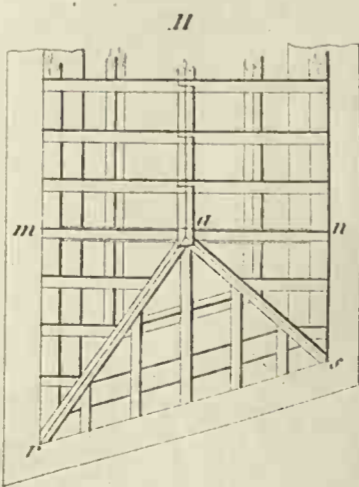
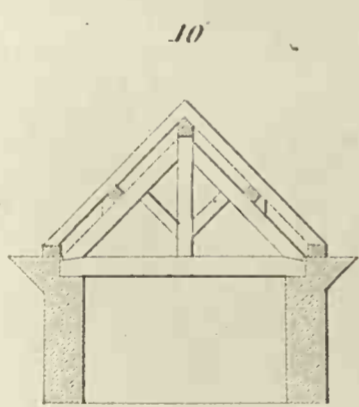
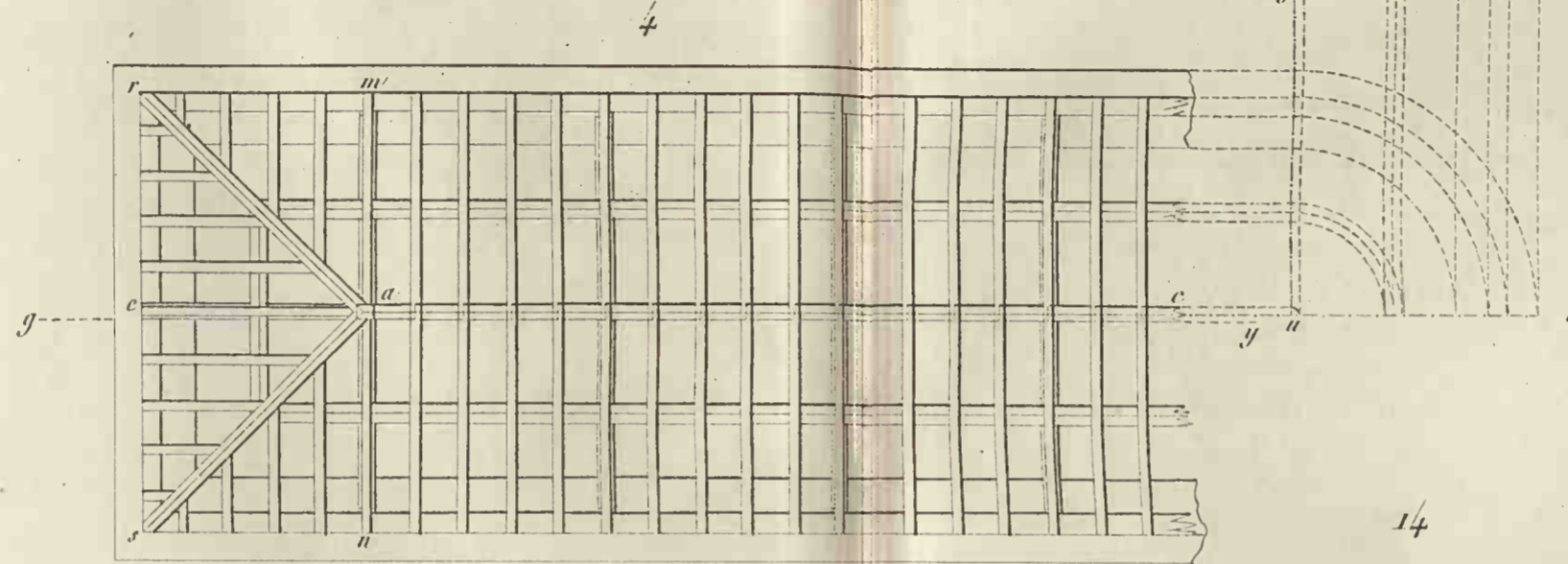
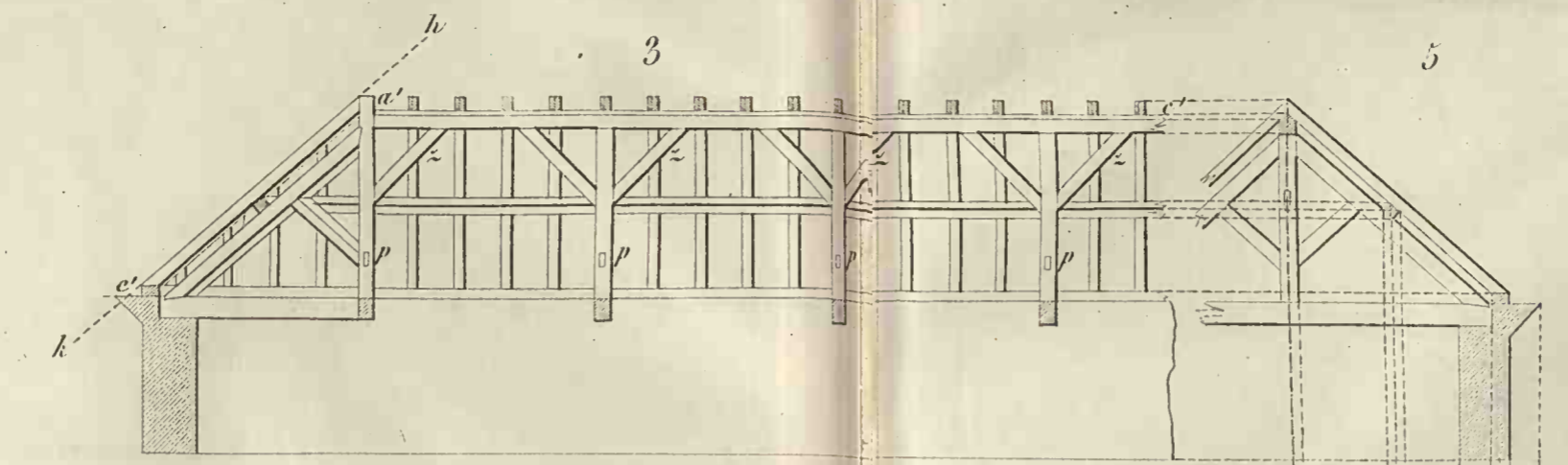
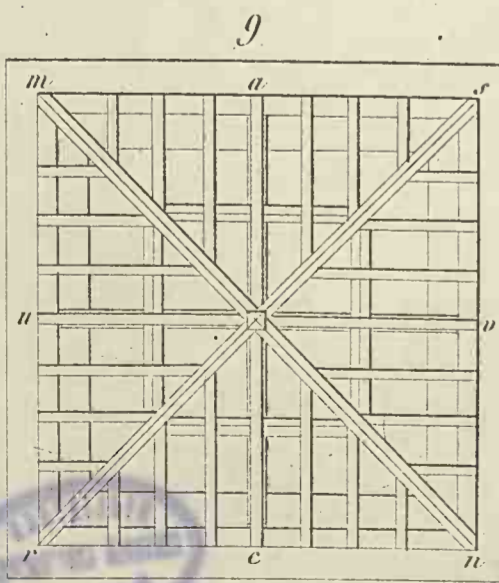
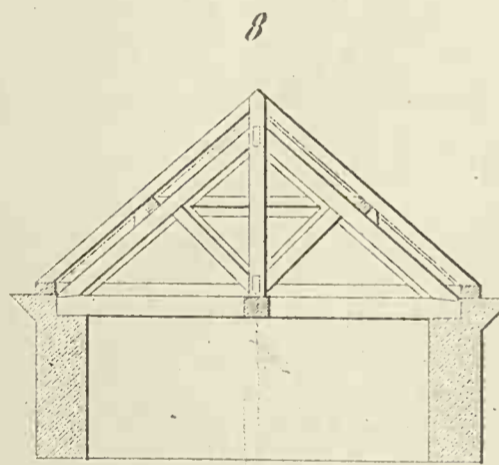
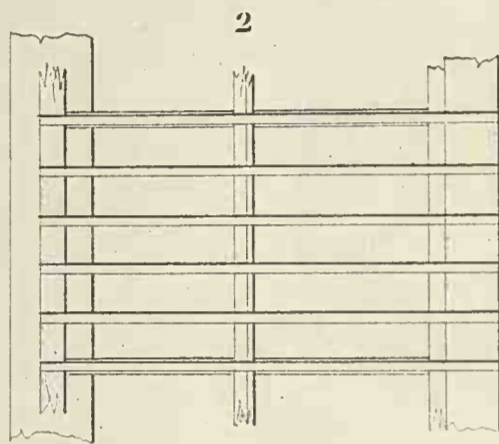
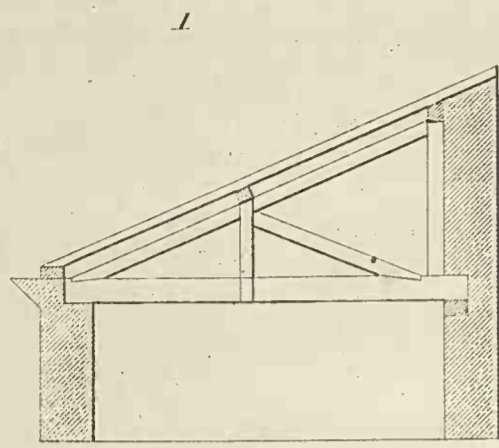

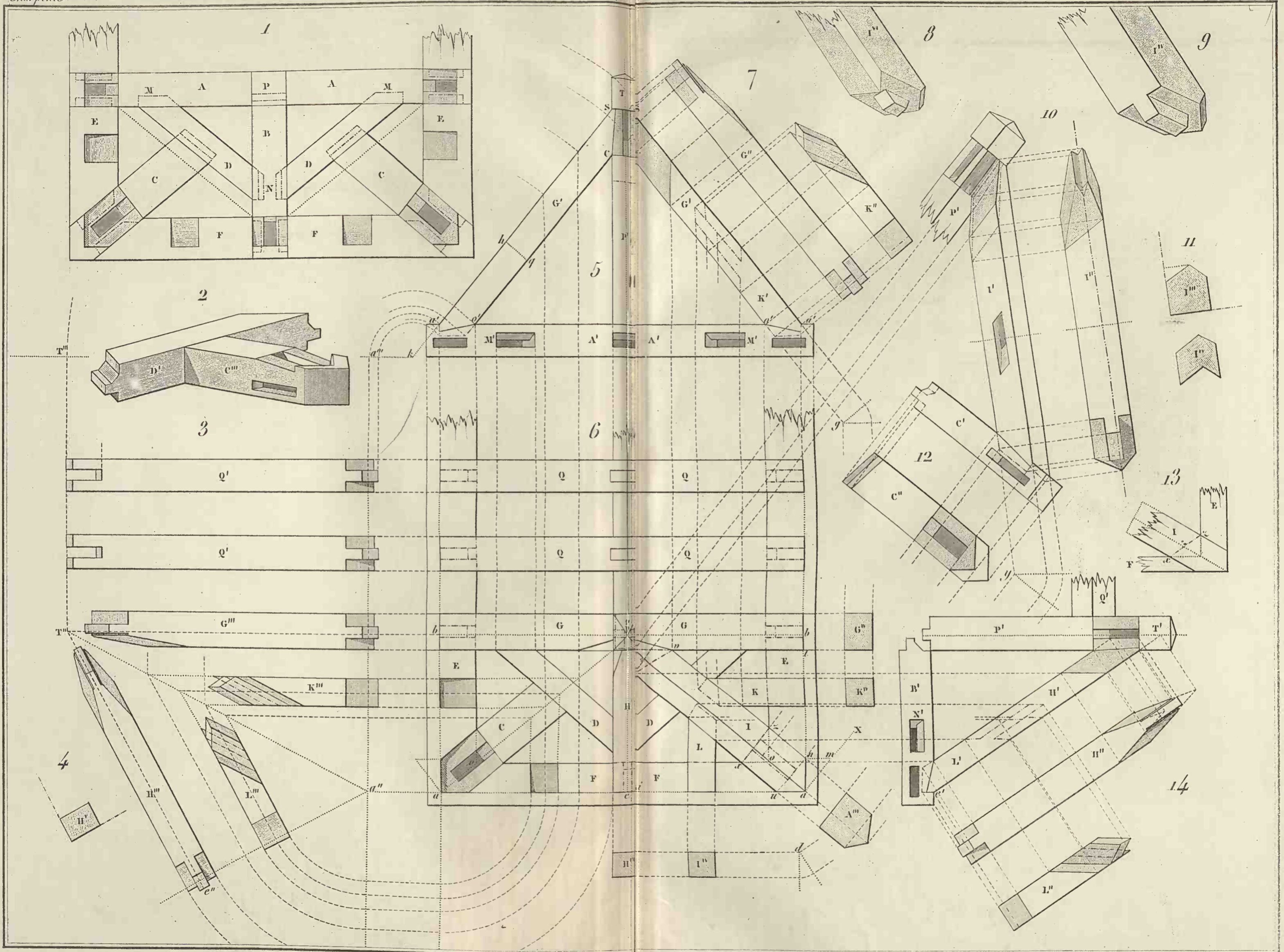

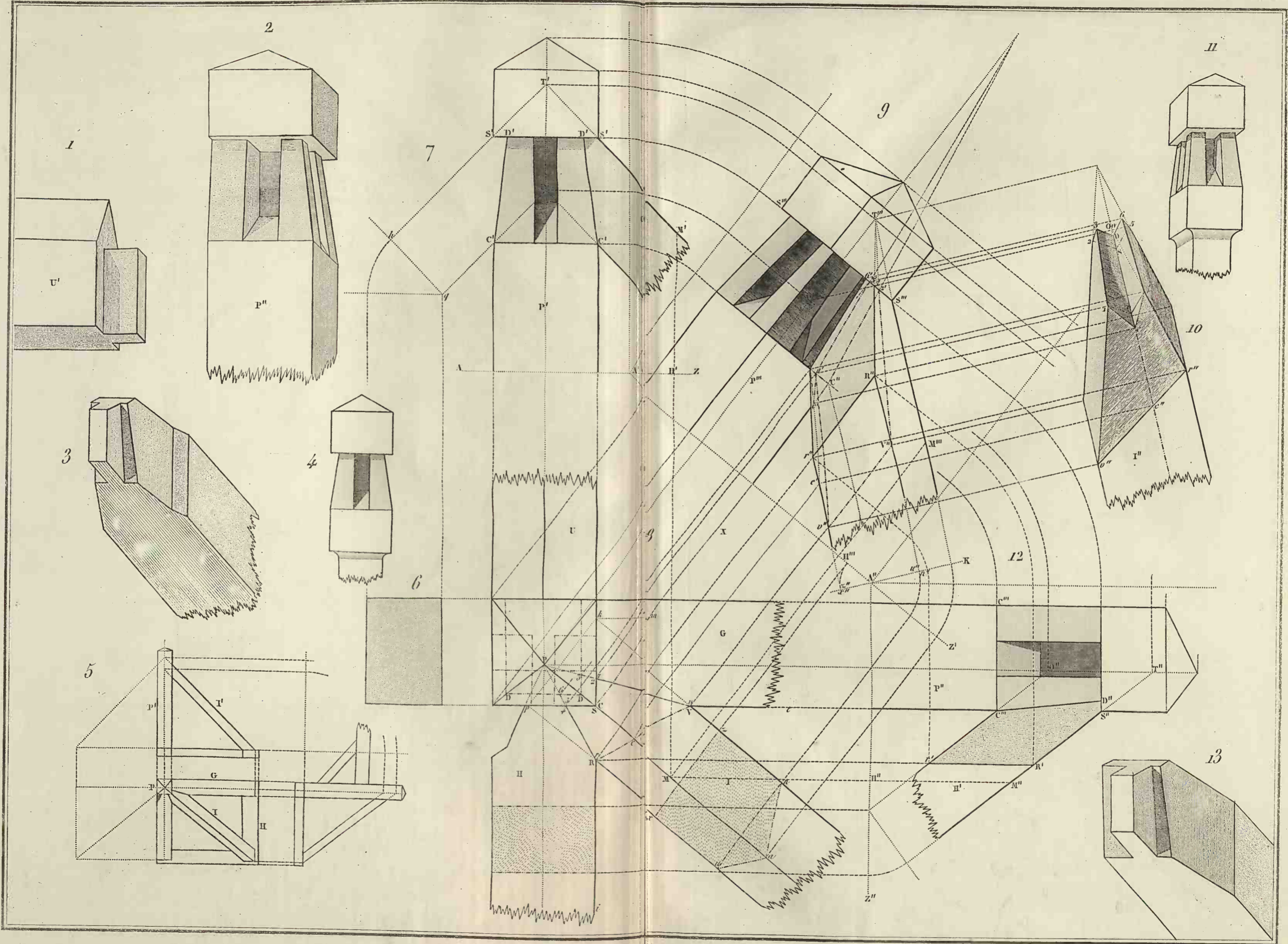

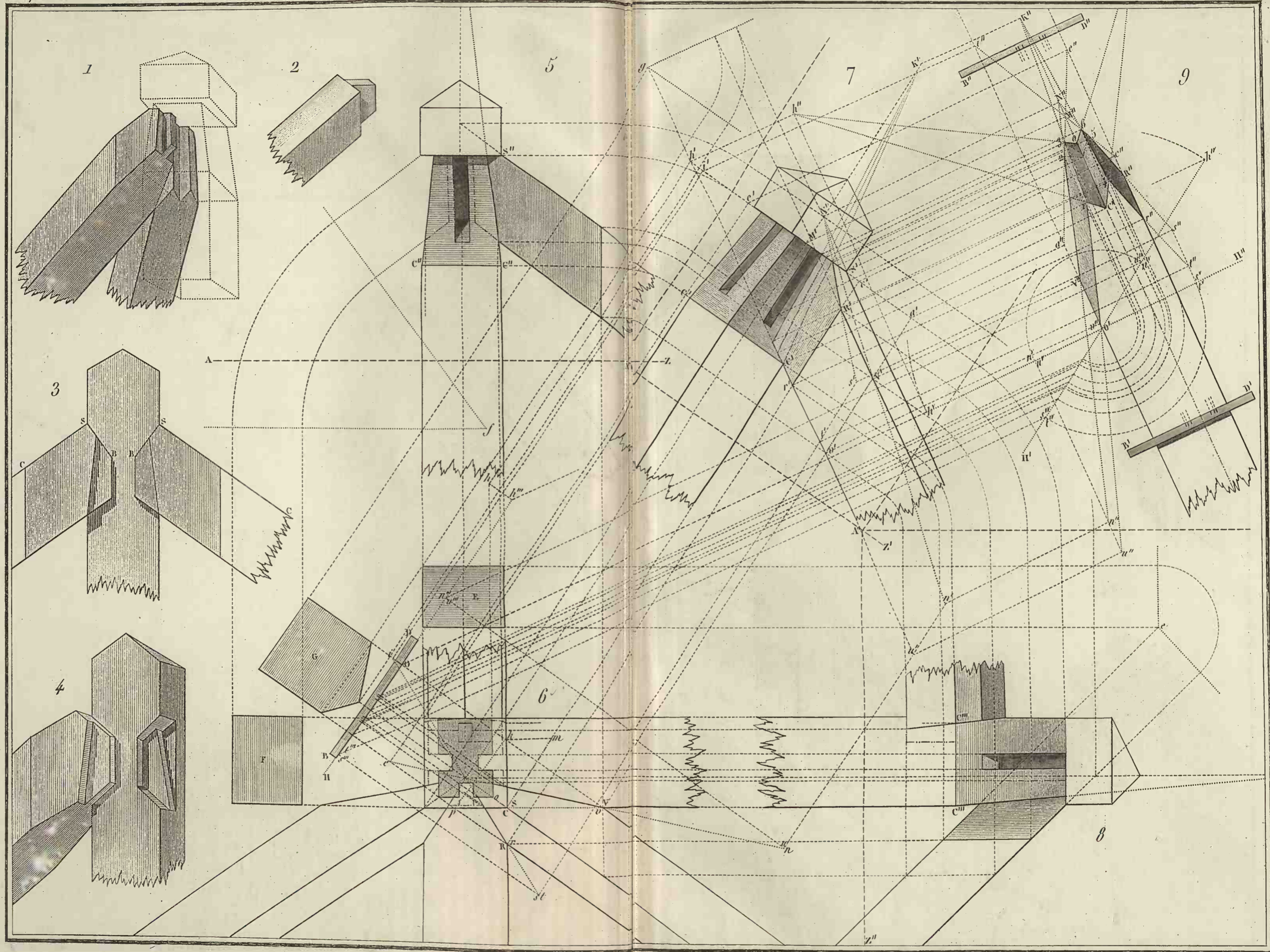

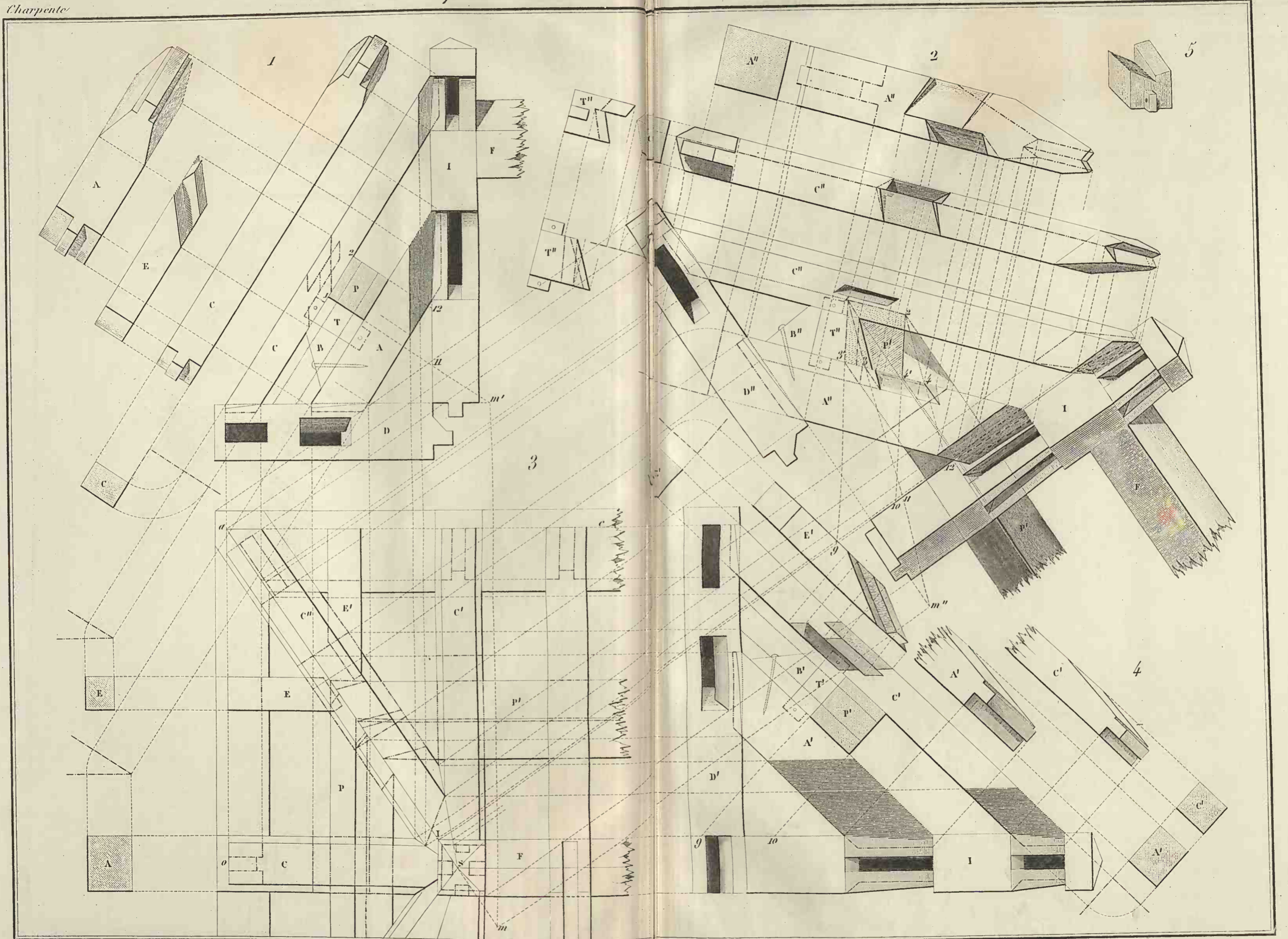

Charpente

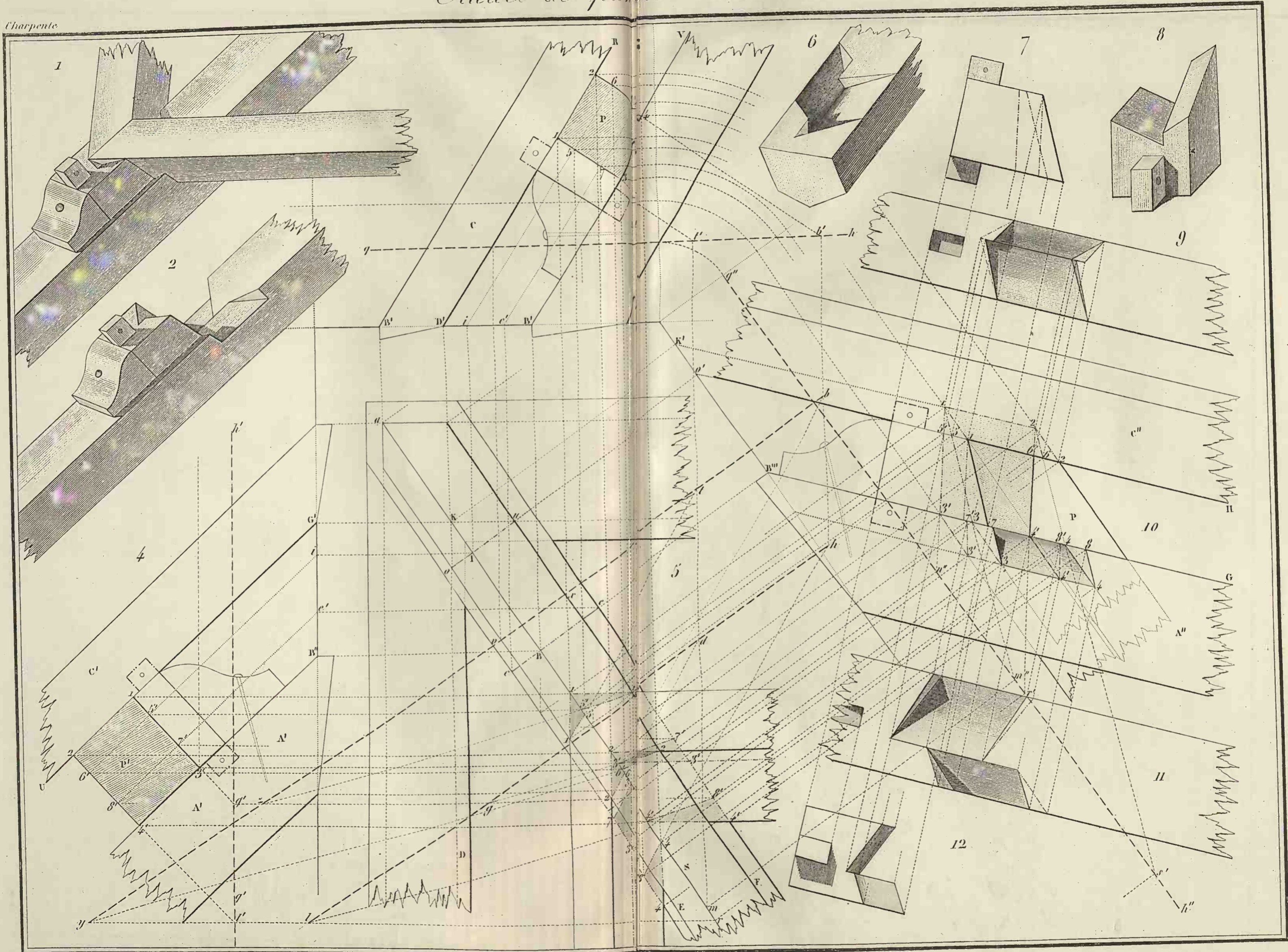

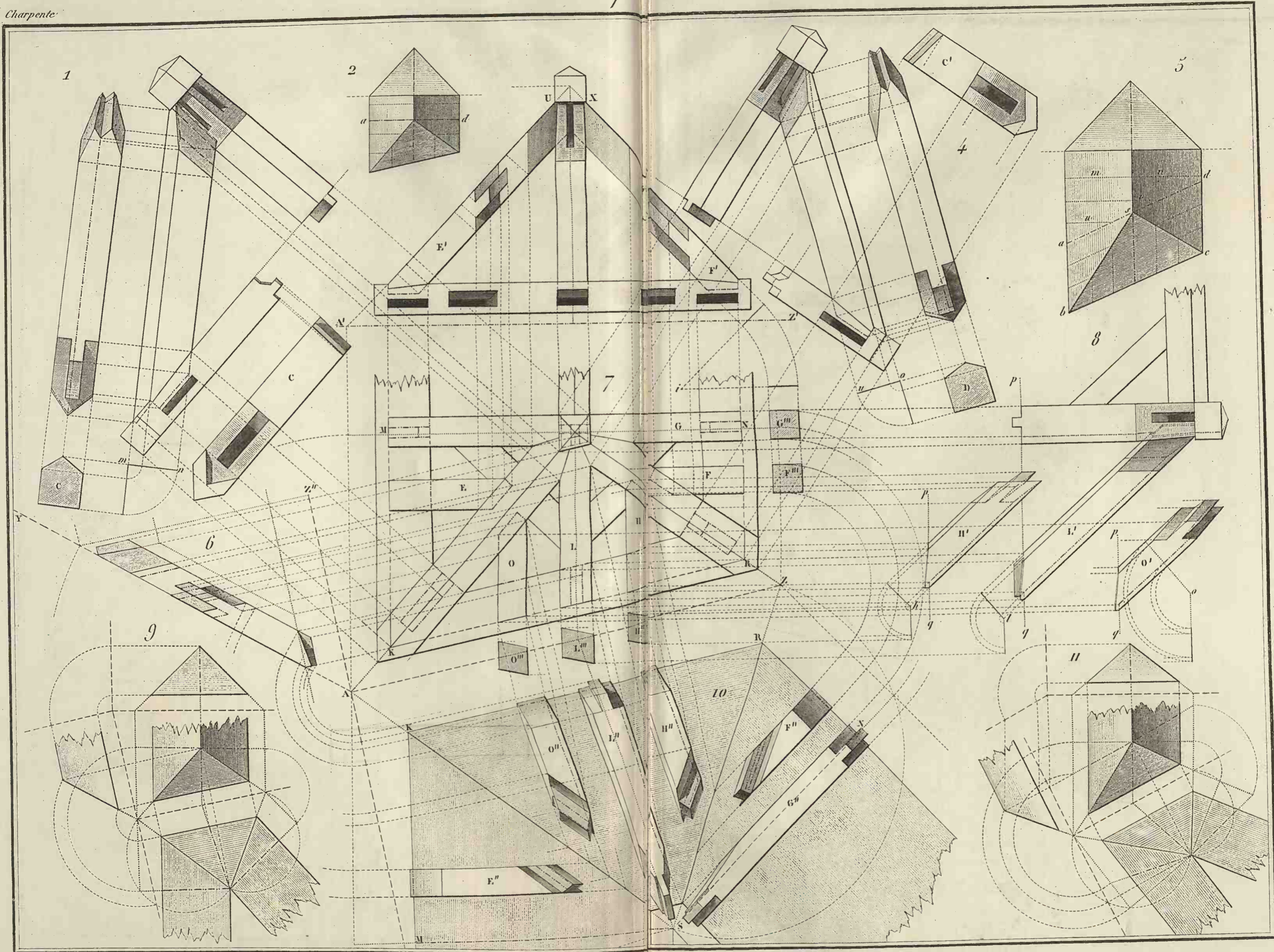

Empañon et charbon de croupe braise

Charpente

Pl. 27

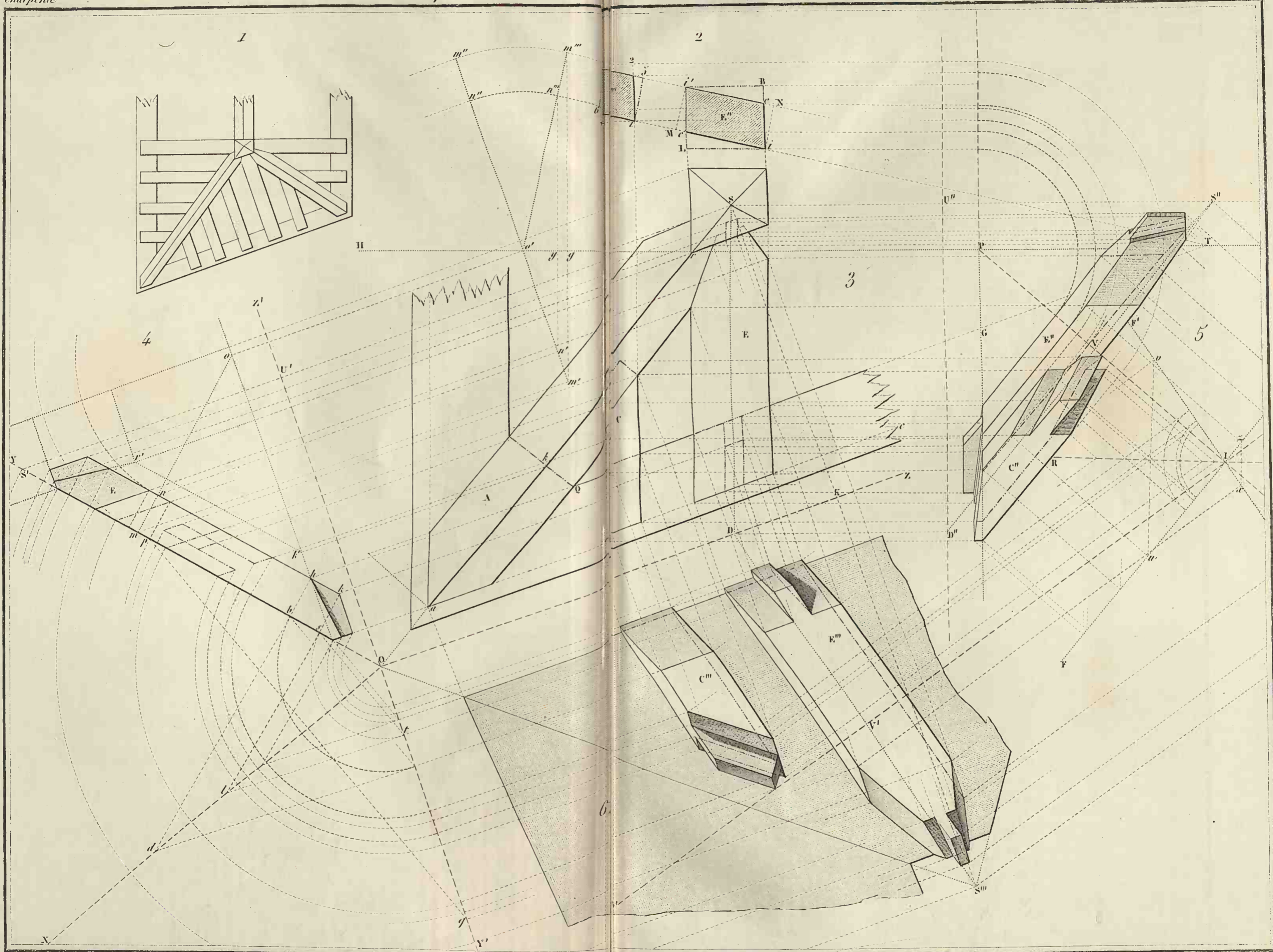

Charpente

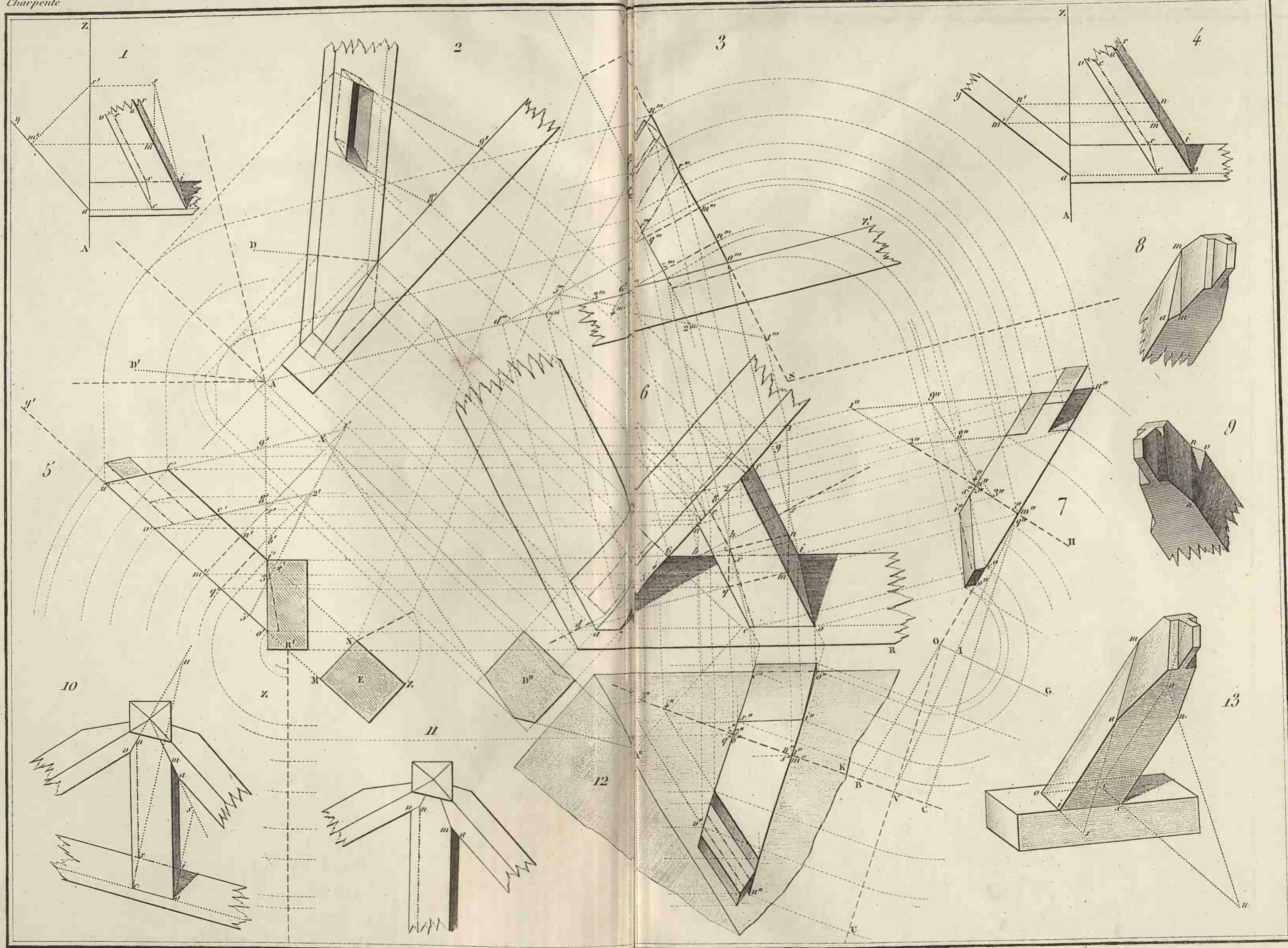

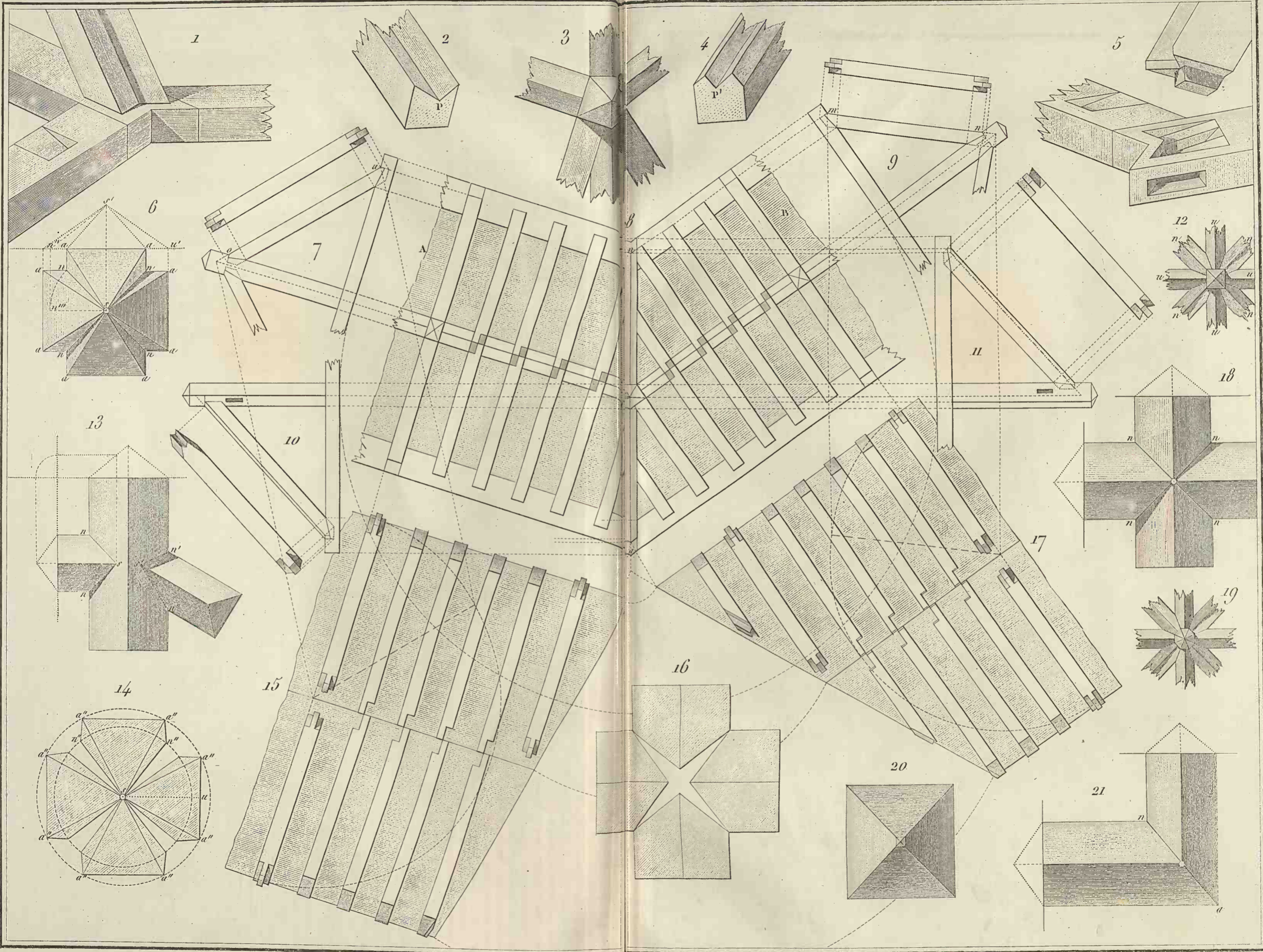

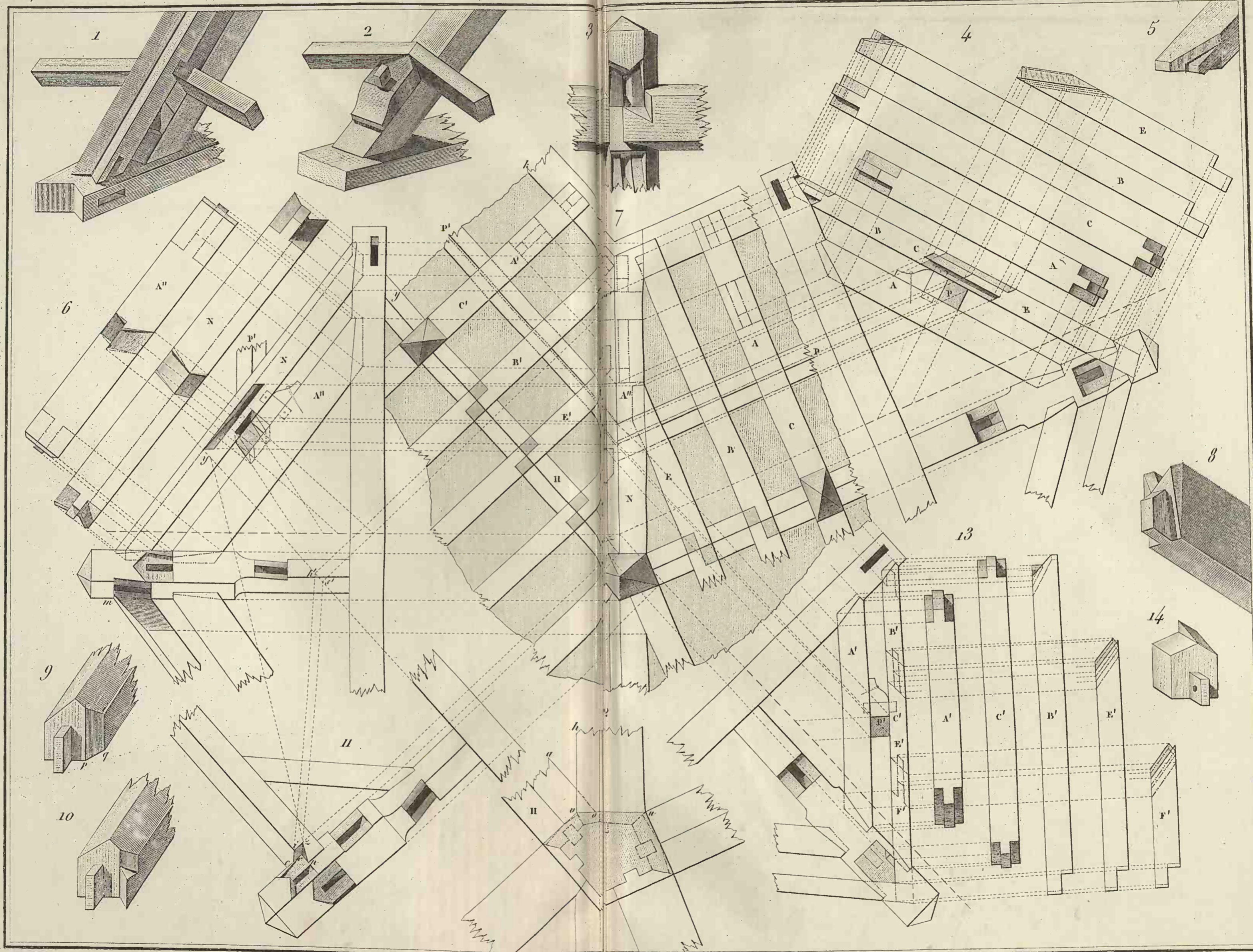

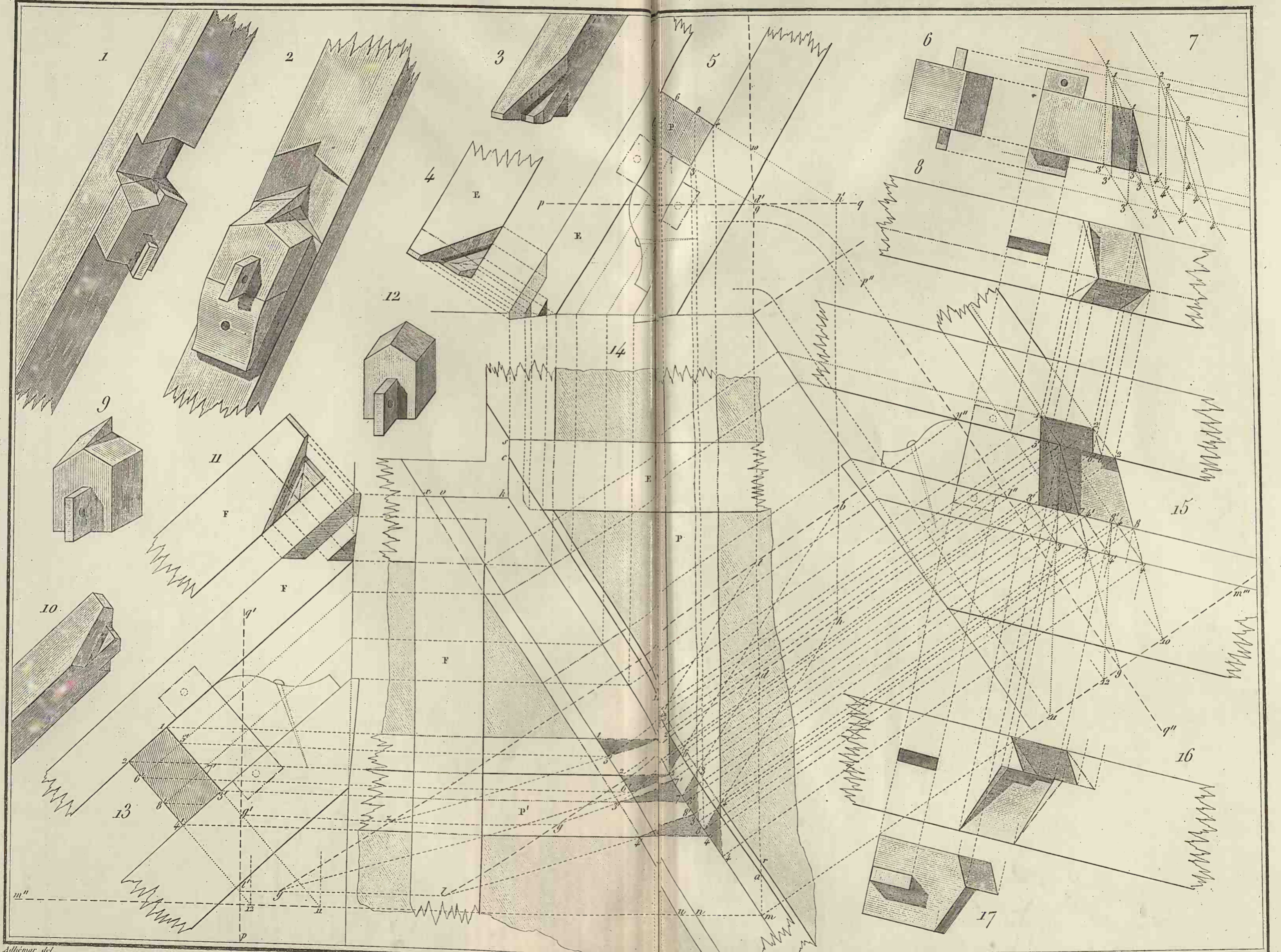

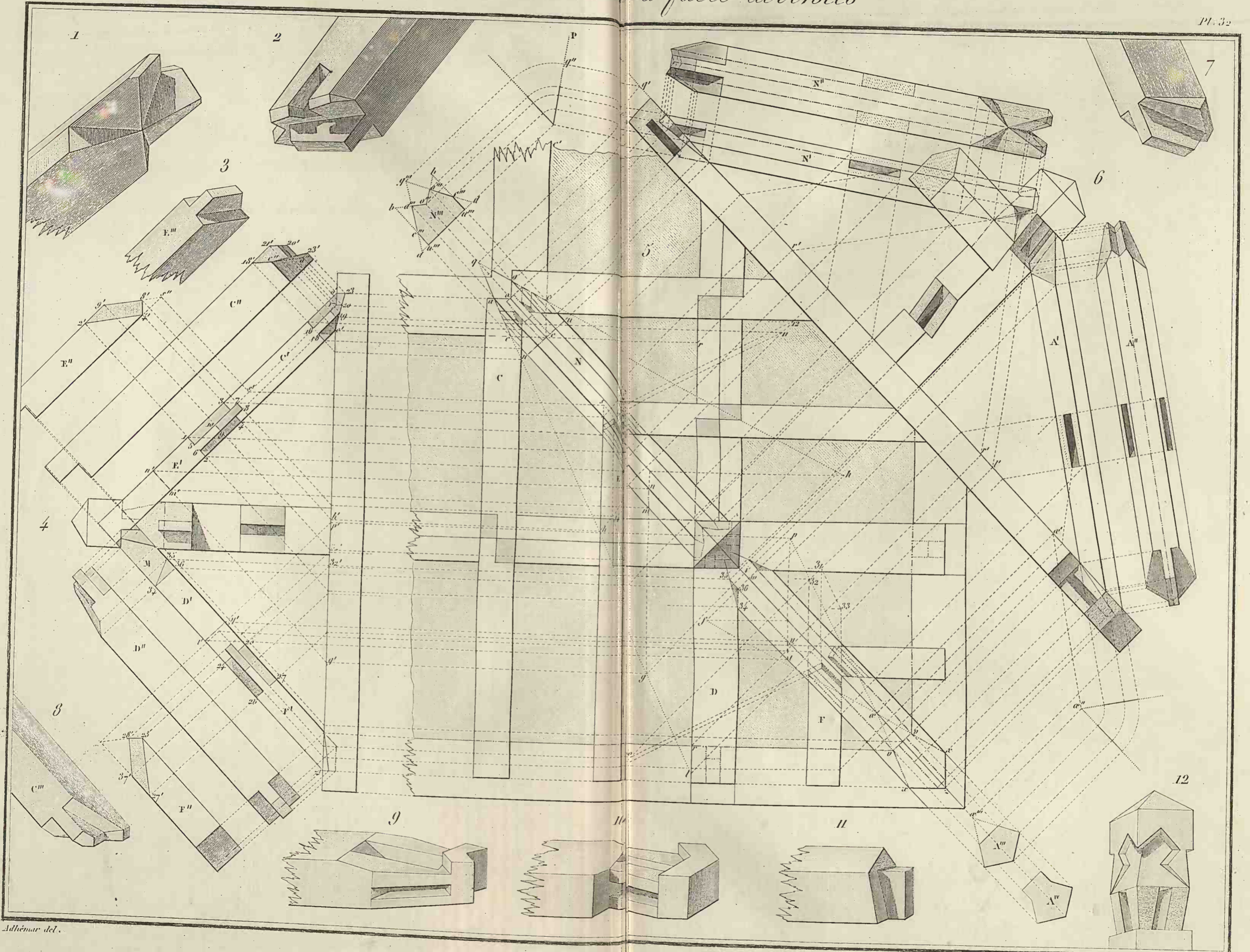

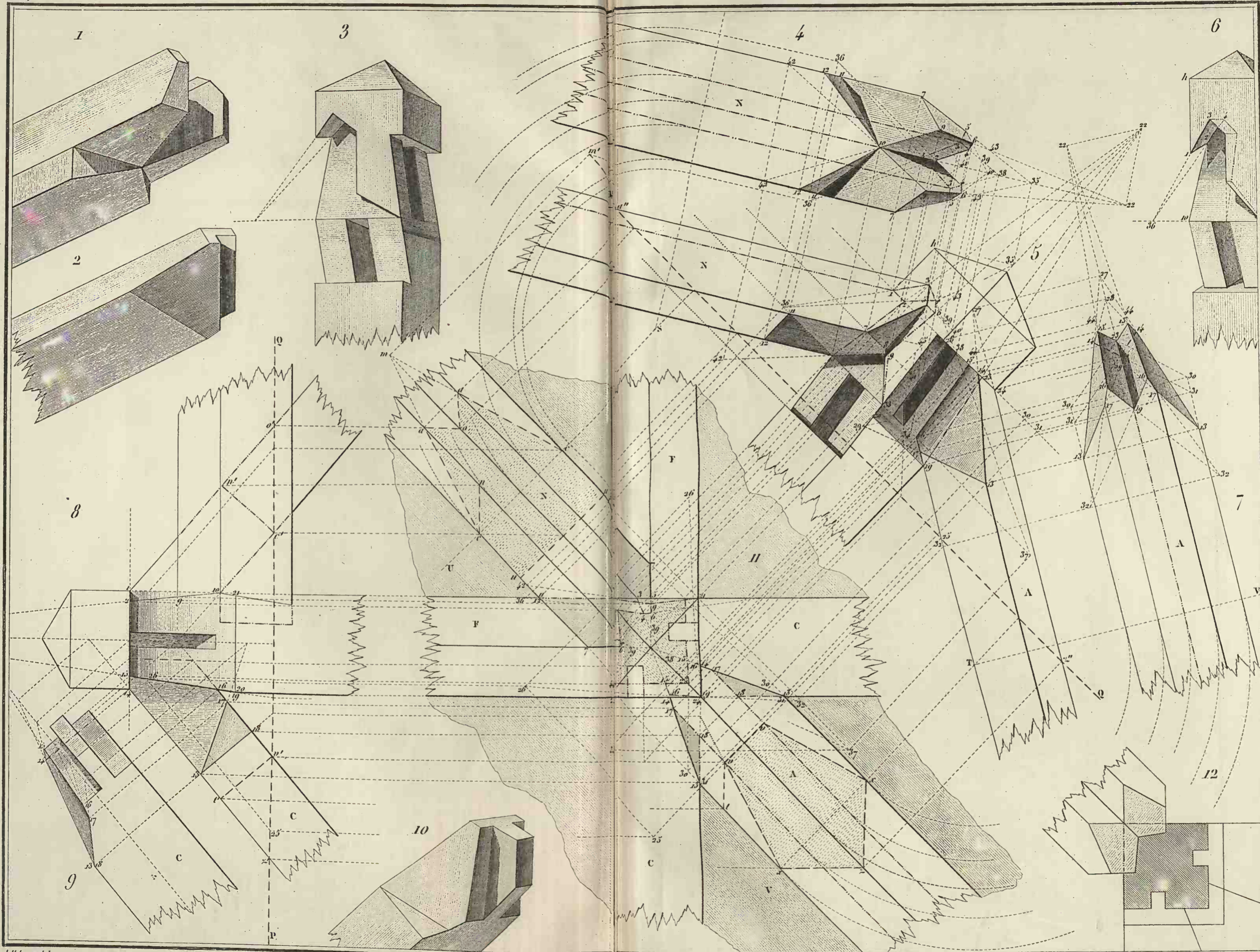

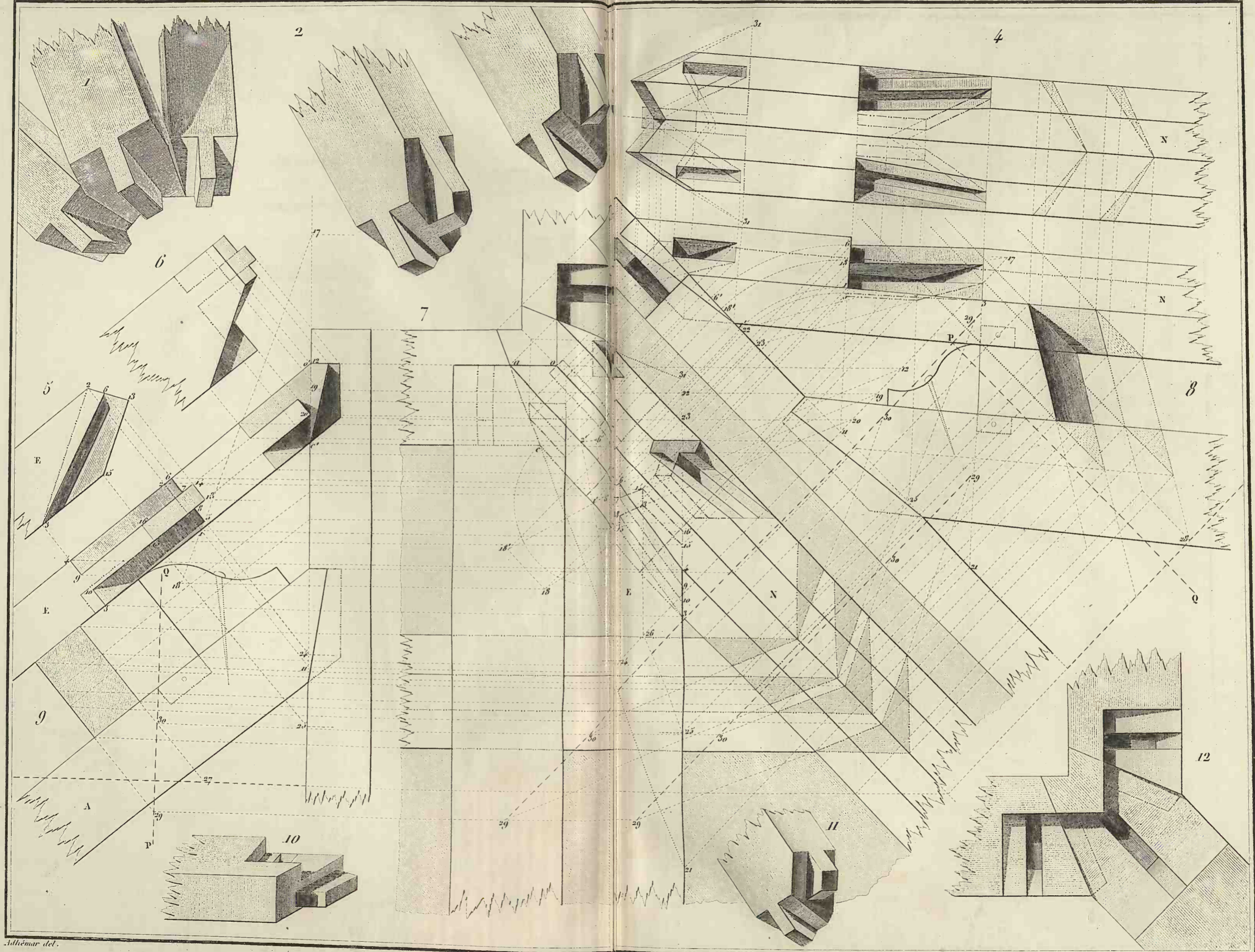

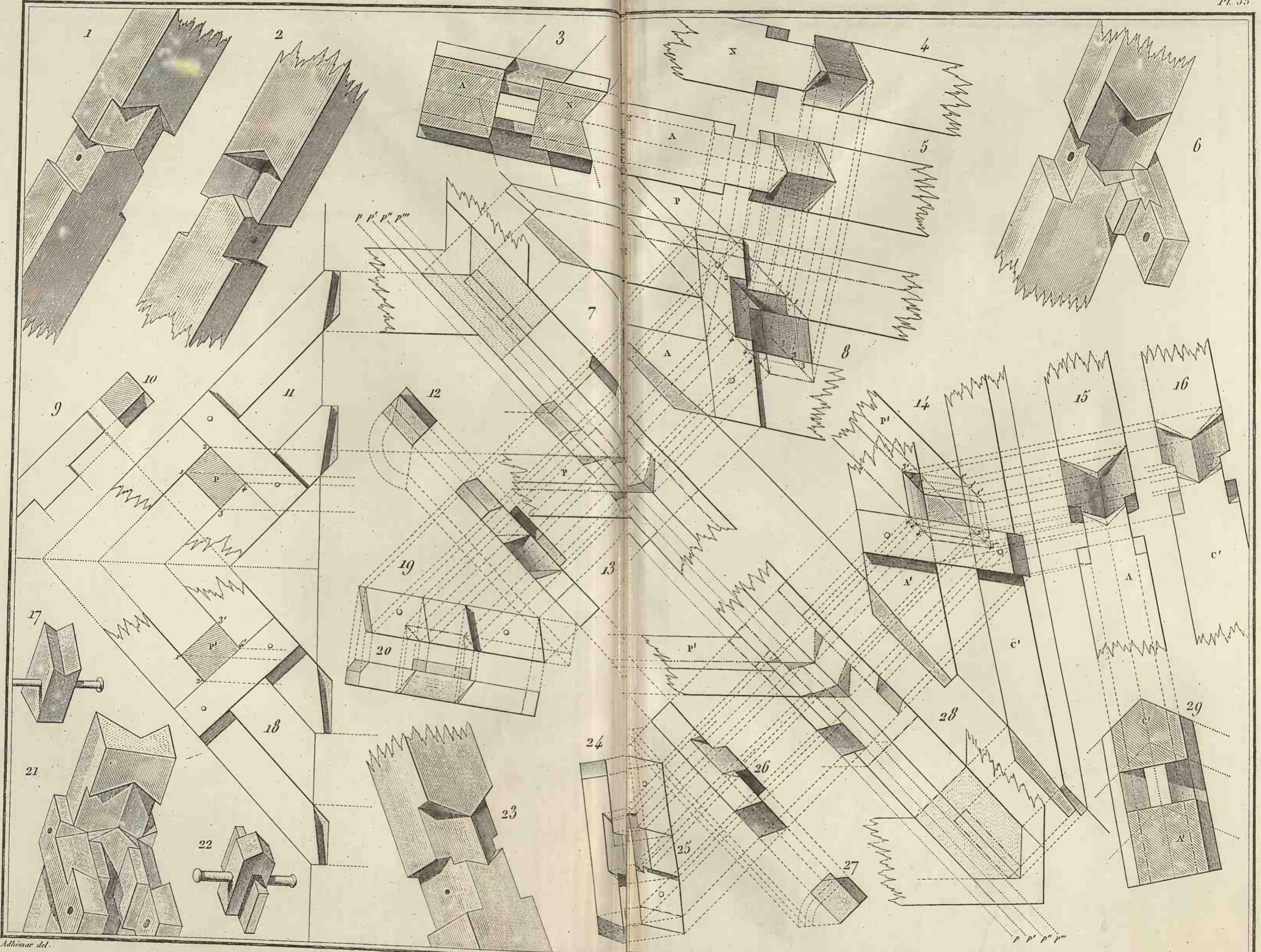

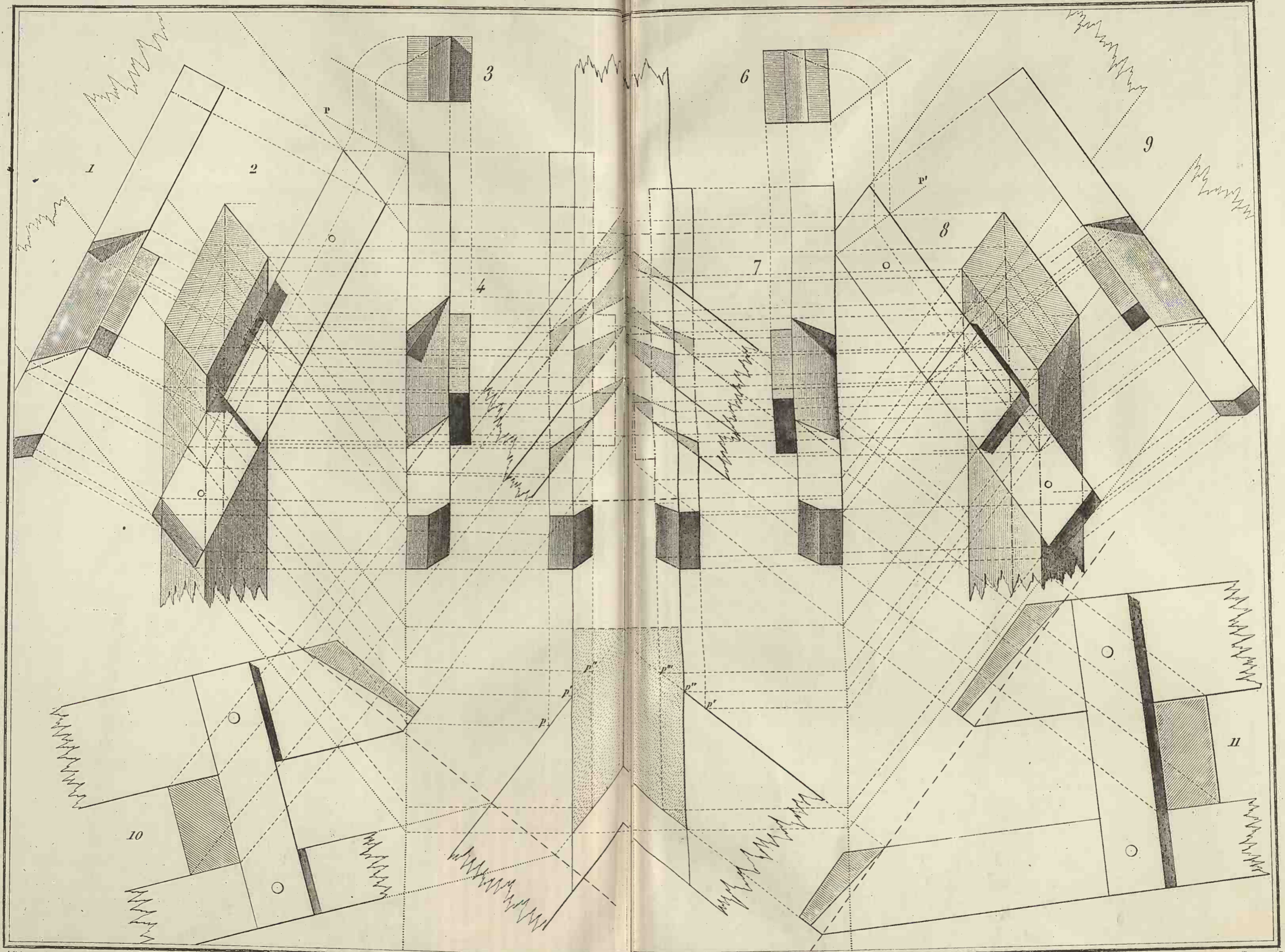

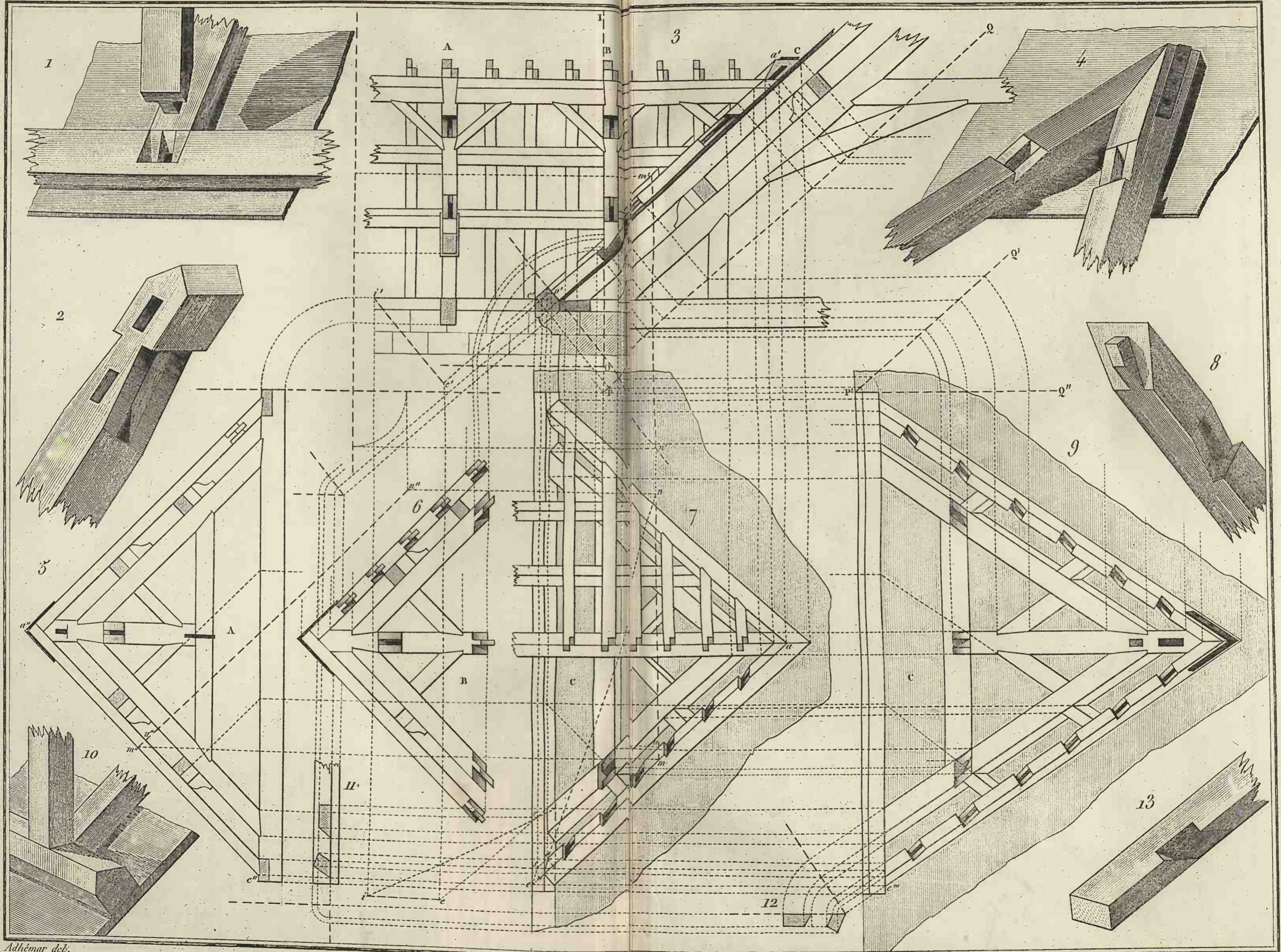

A=B=C
A=B=1
A=1/B

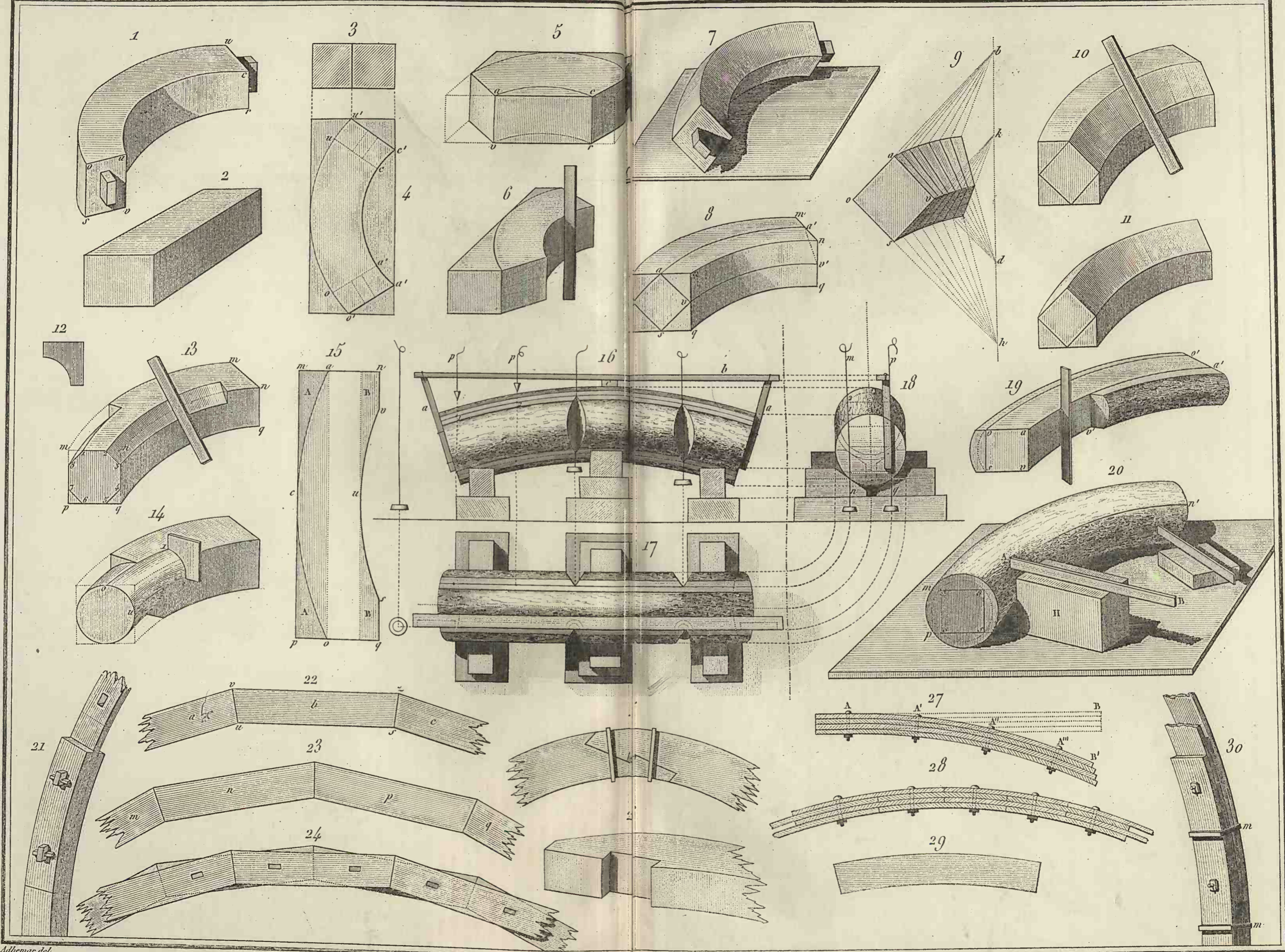

Surfaces courbes.

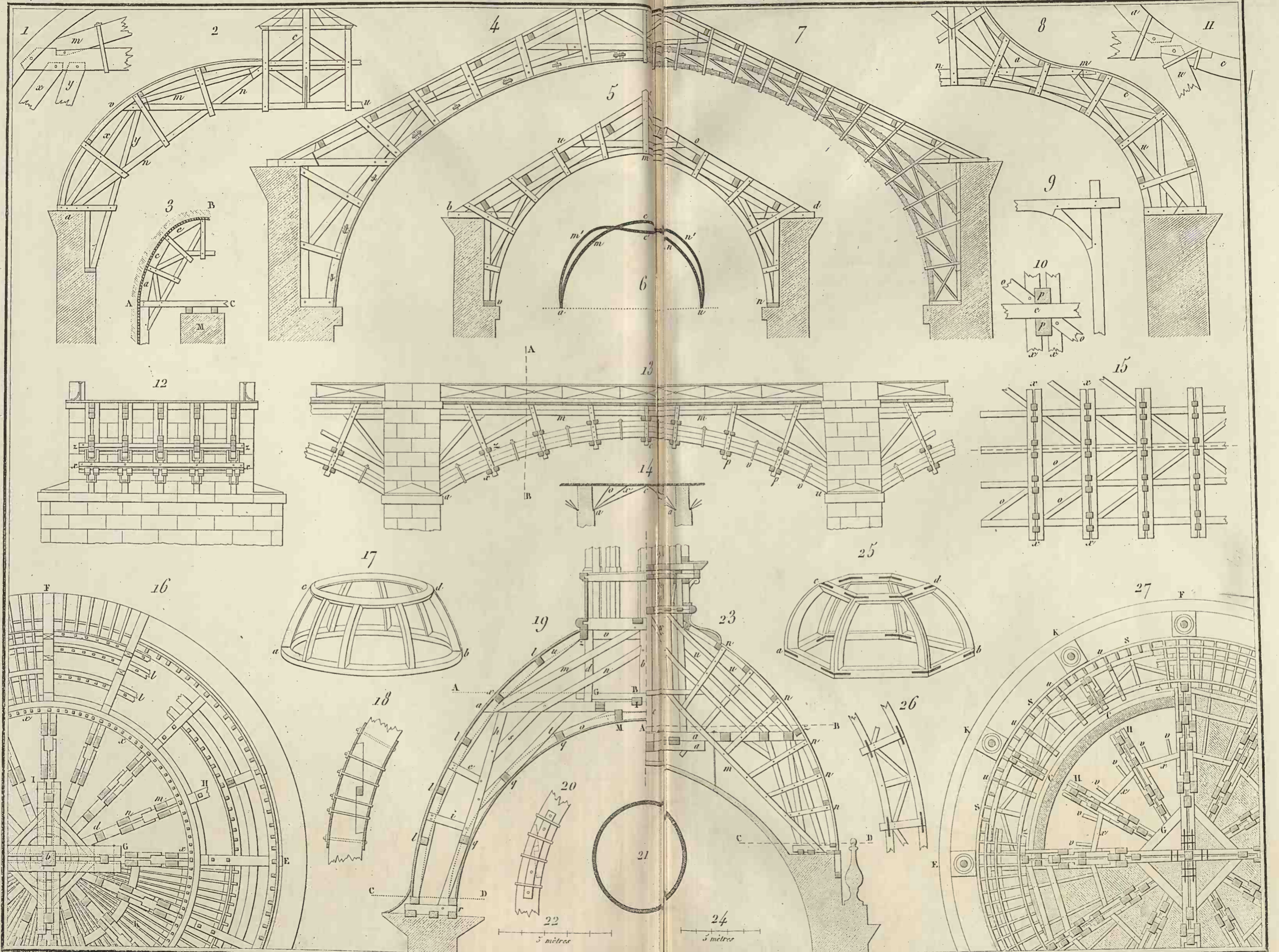

Berceaux cylindriques

Charpente

Pl. 40.

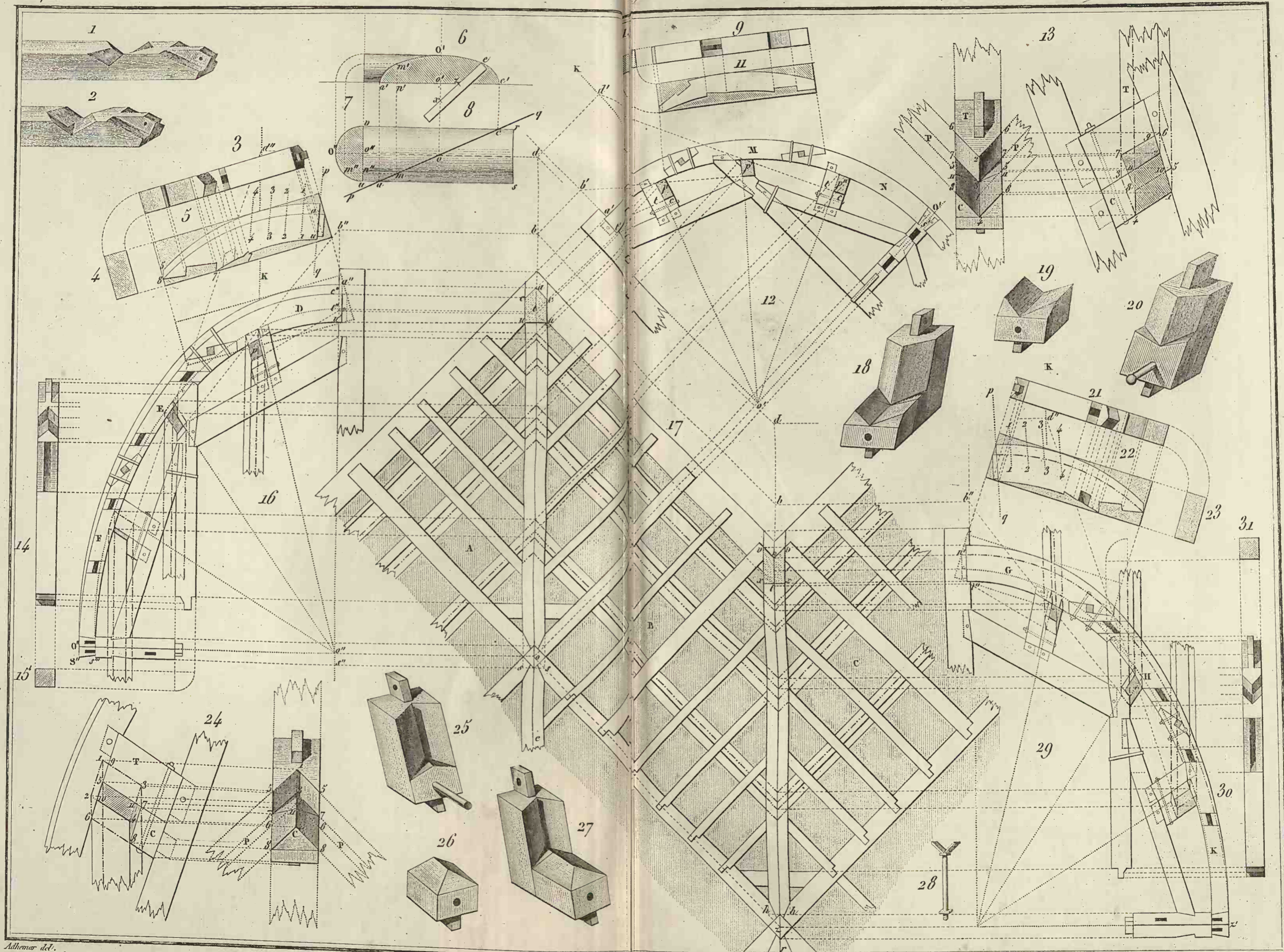

Adhemar del.

Durau sc.

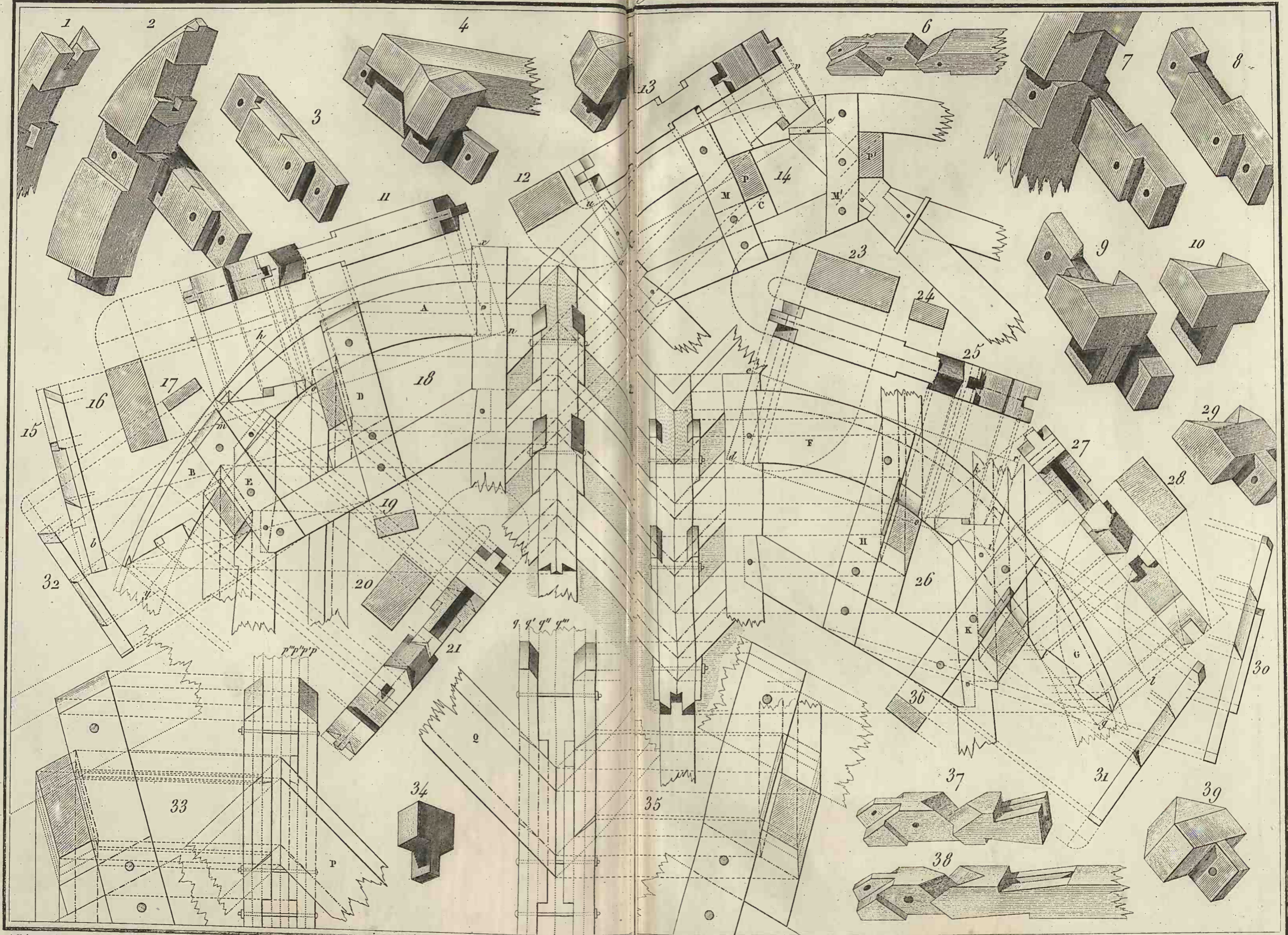

Berceaux cylindriques

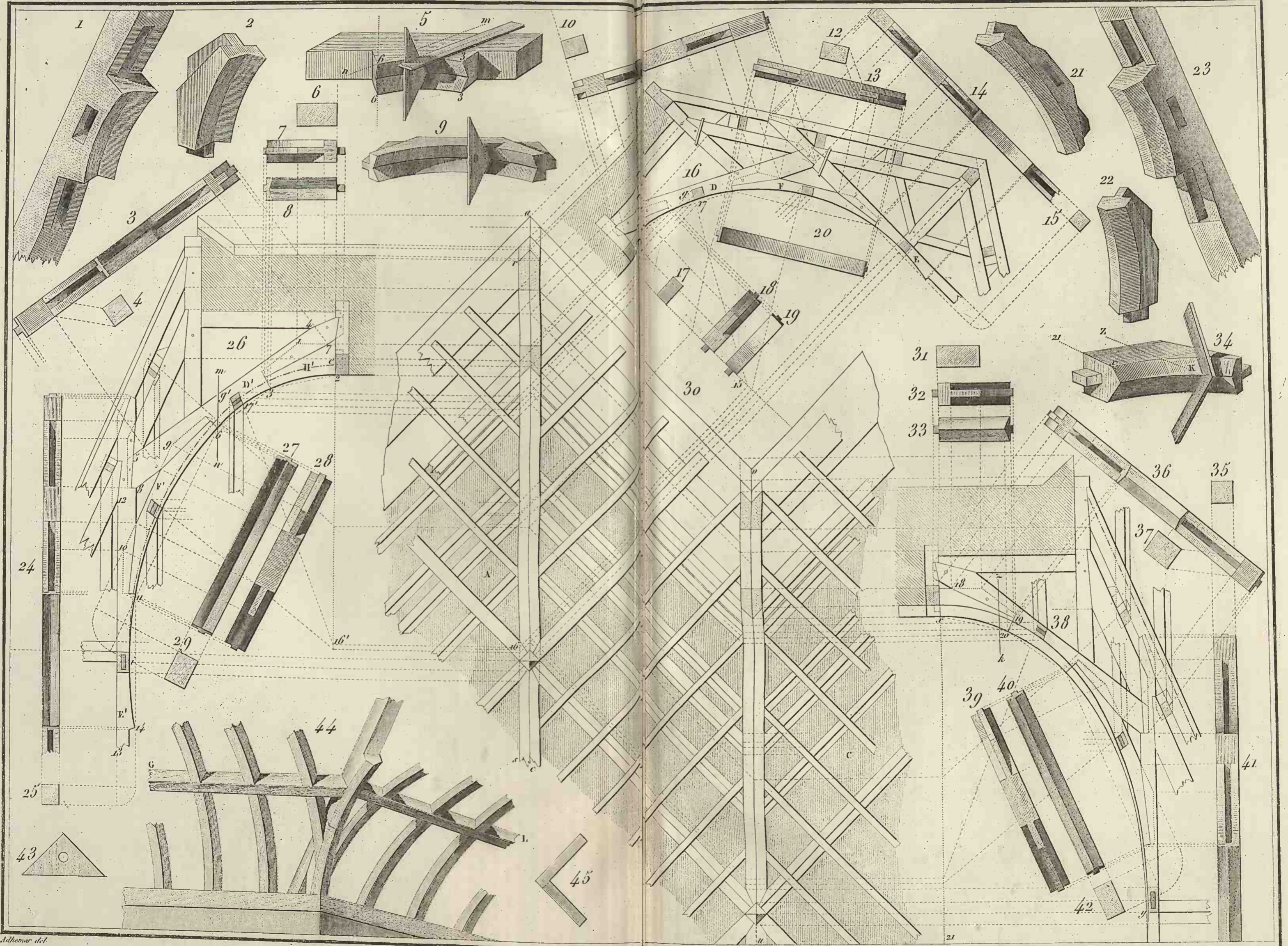

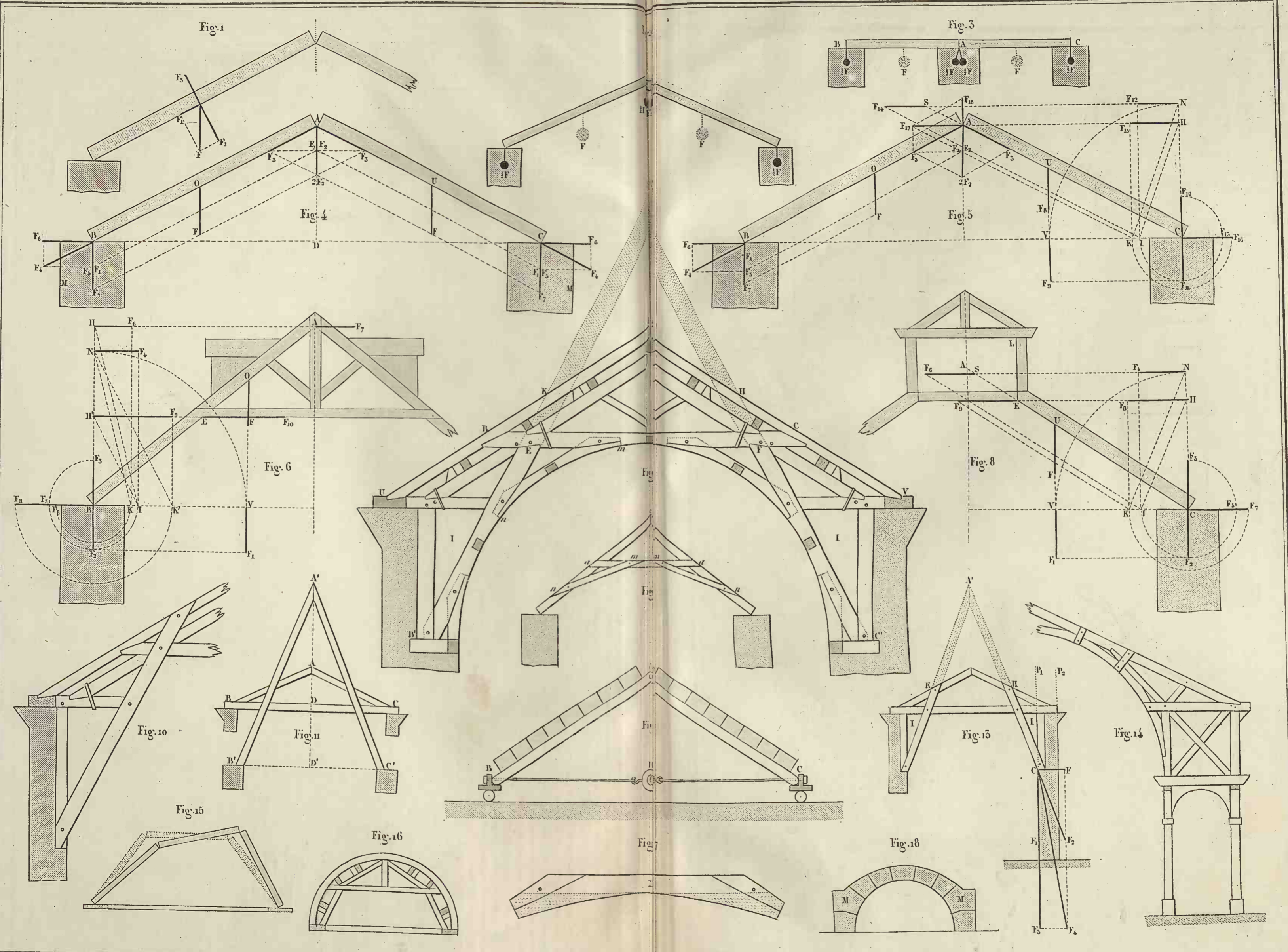

Courbes, lances.

Charpente

Pl. 44.

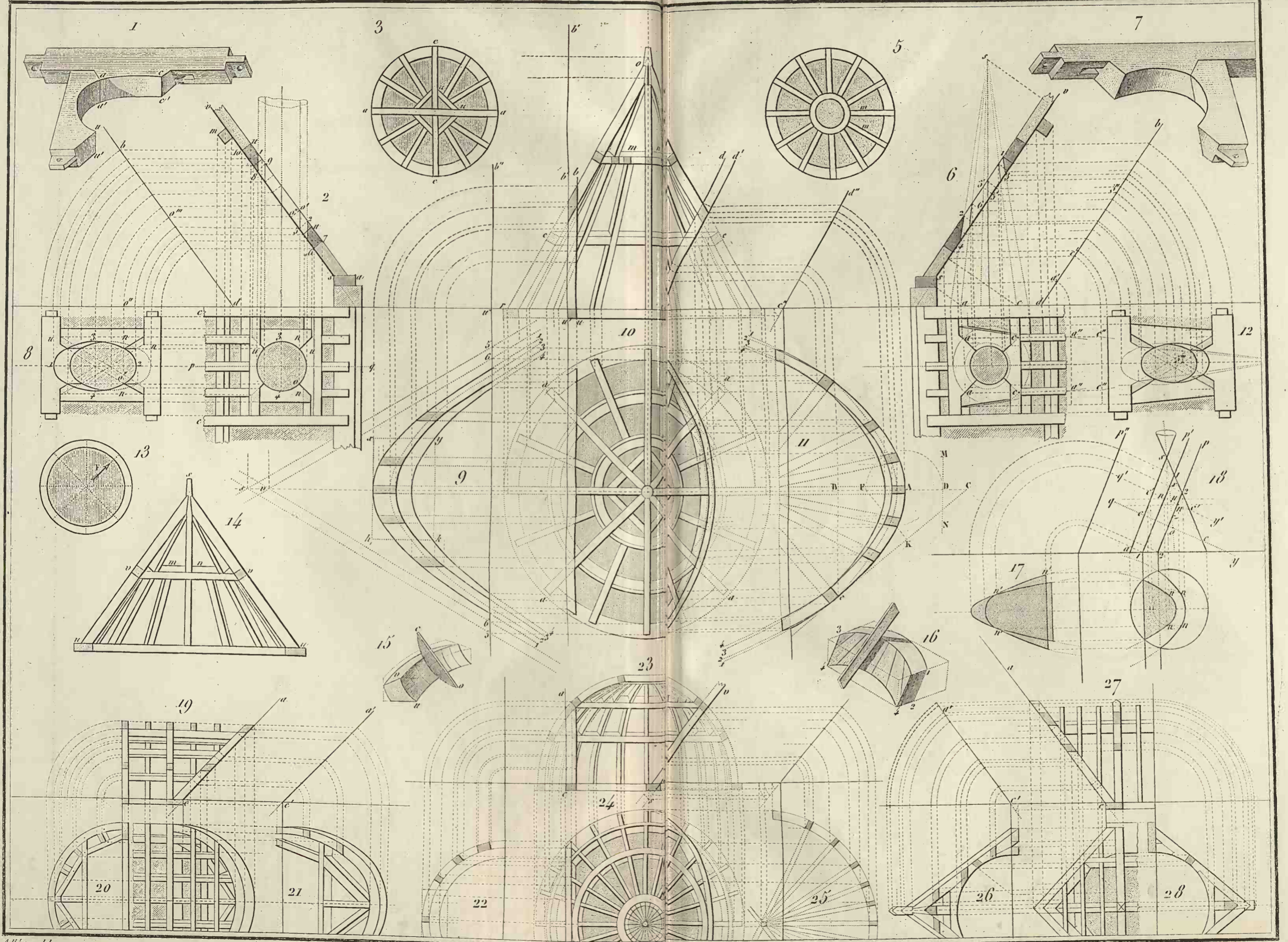

Voûtes cylindriques et coniques

Charpente.

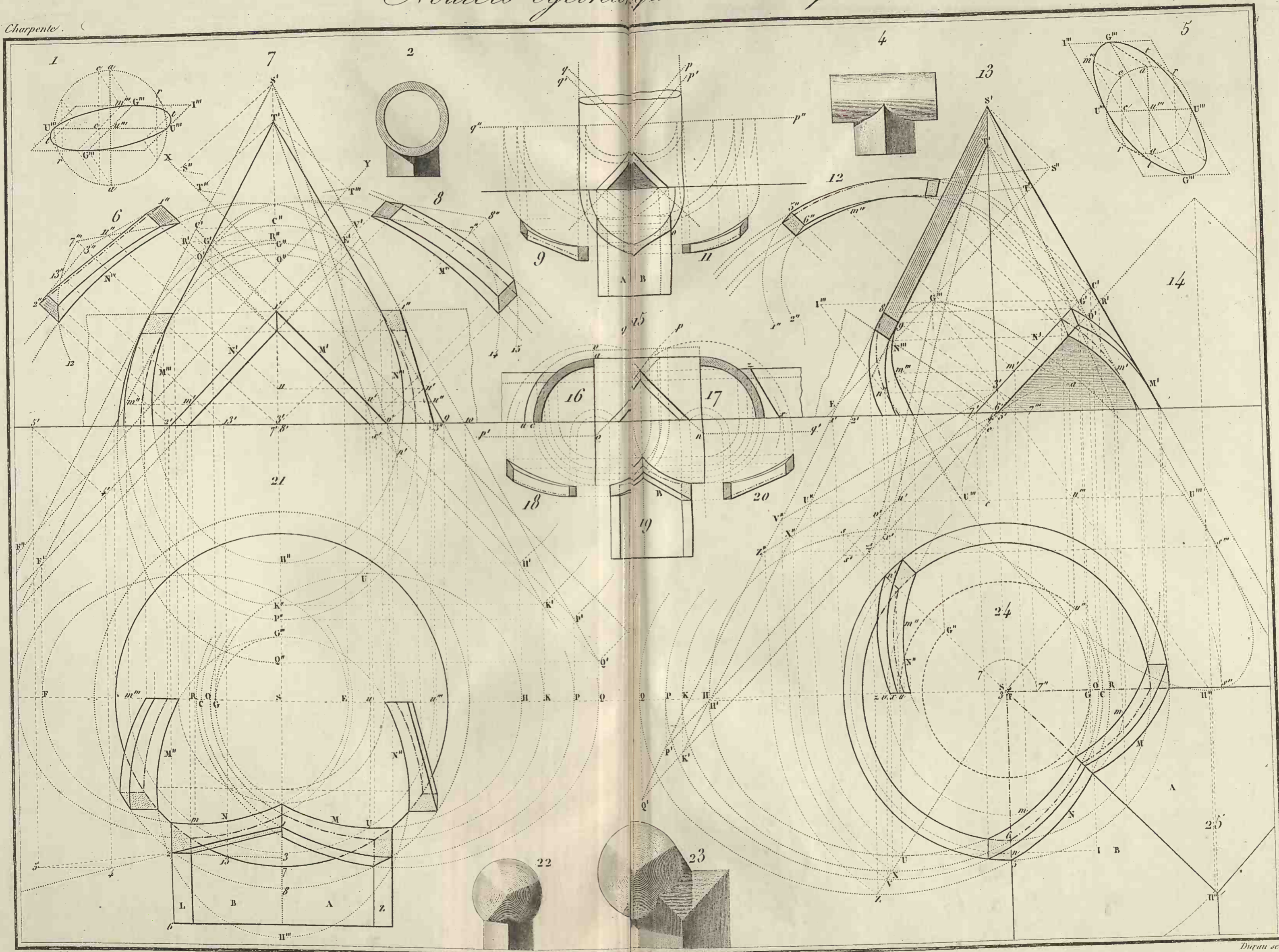

Voûtes sphériques.

Charpente

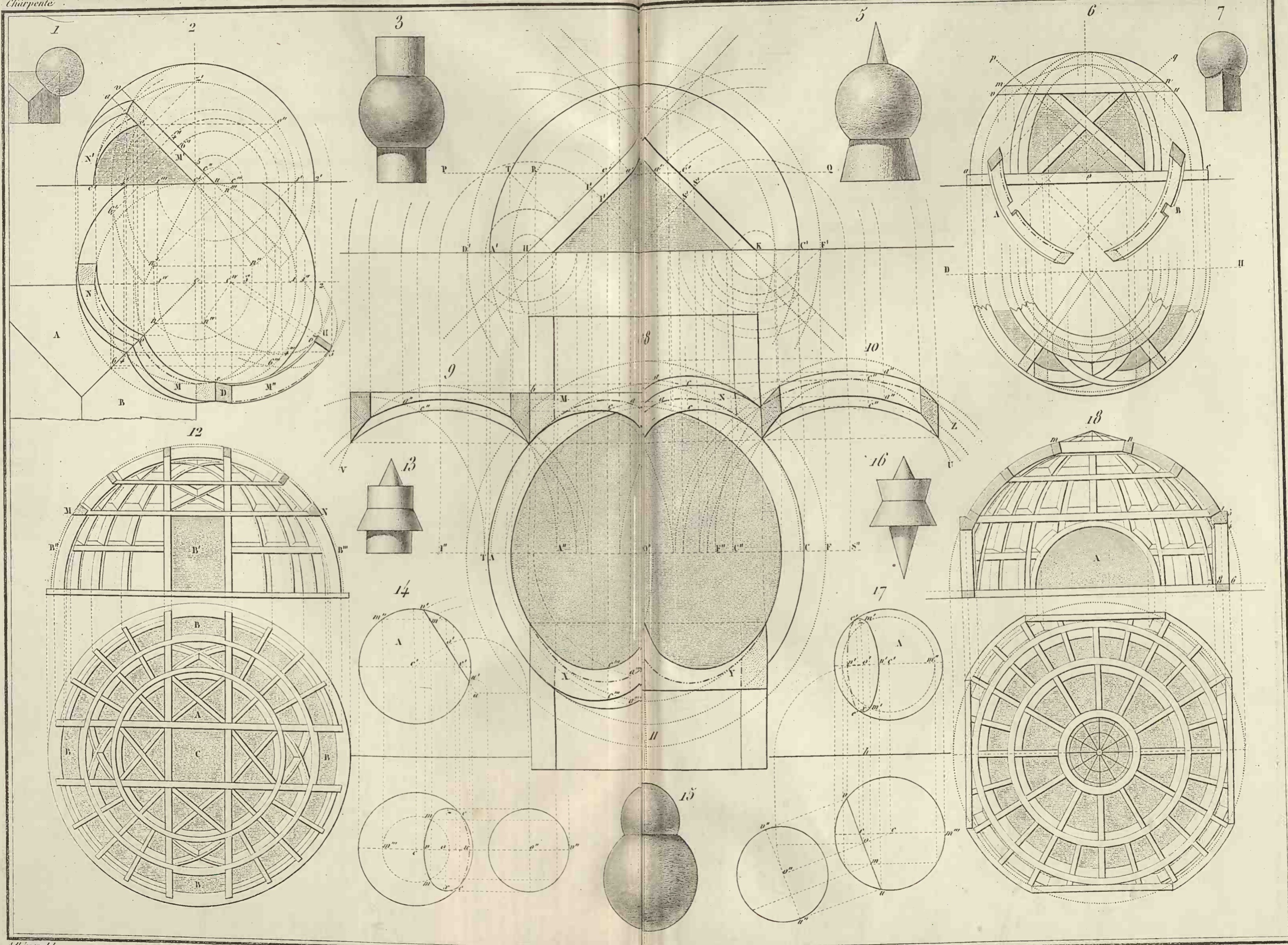

Croix de St. André

Charpente

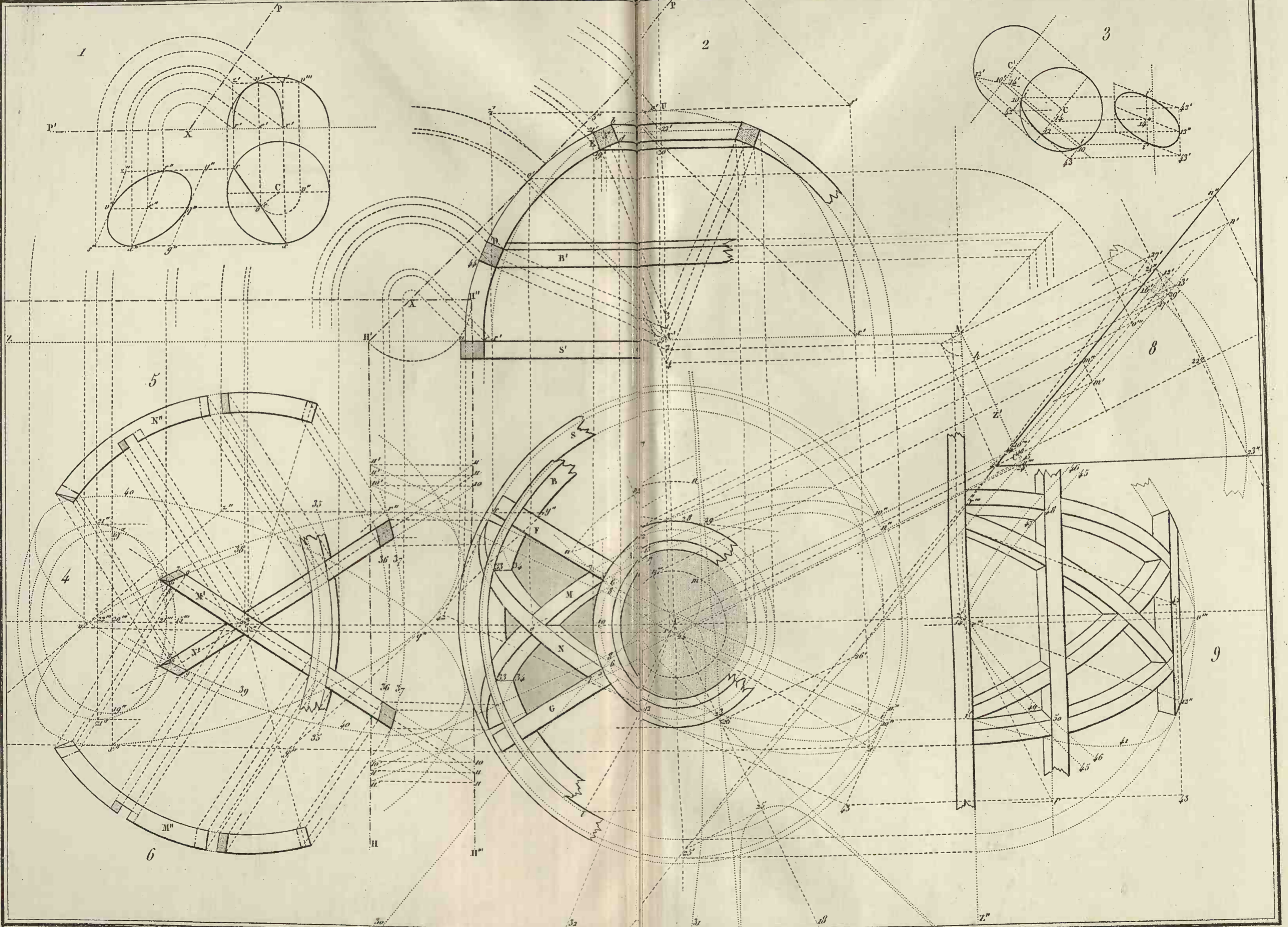

Adhémar del.

Durand sc.

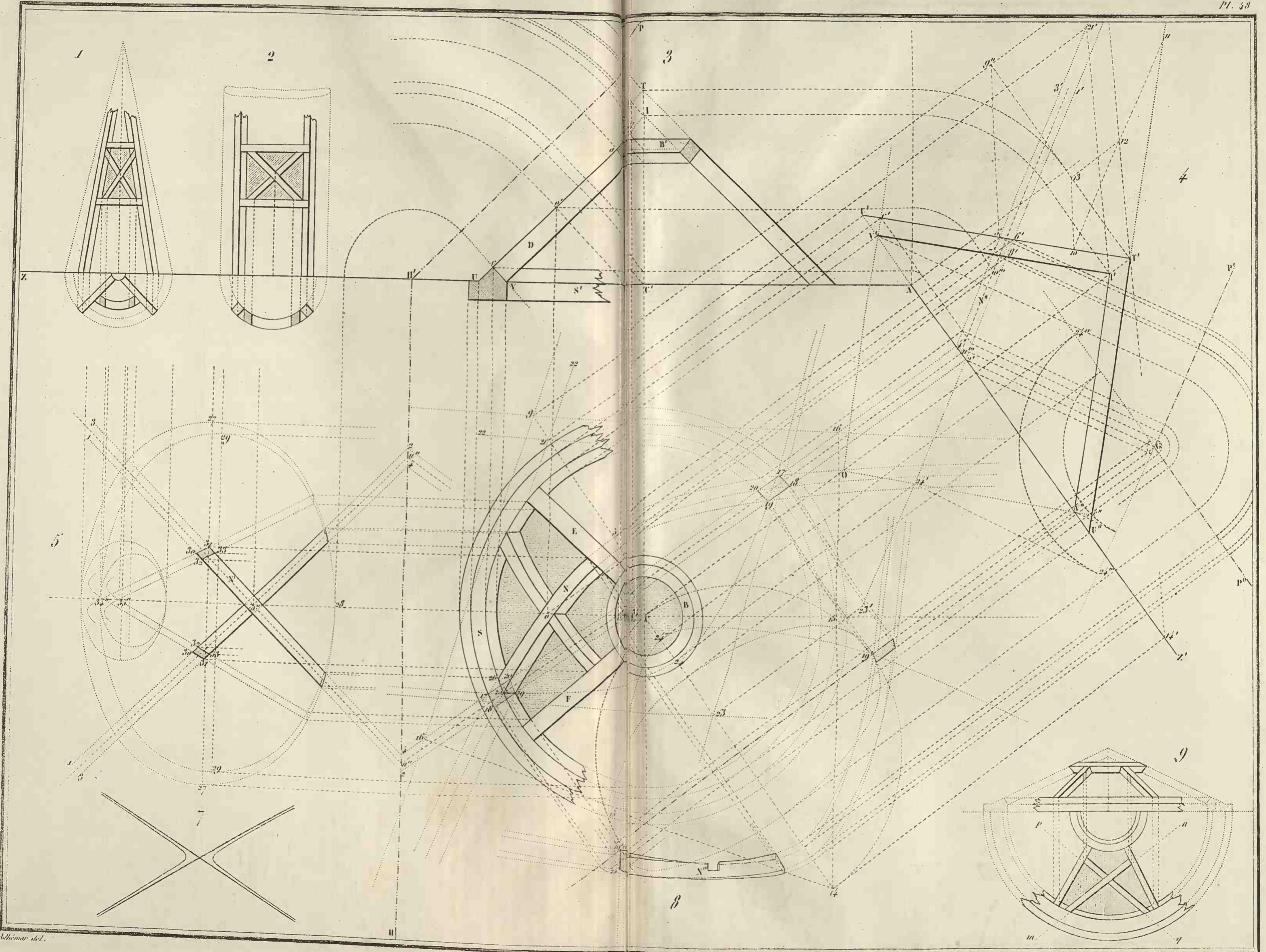

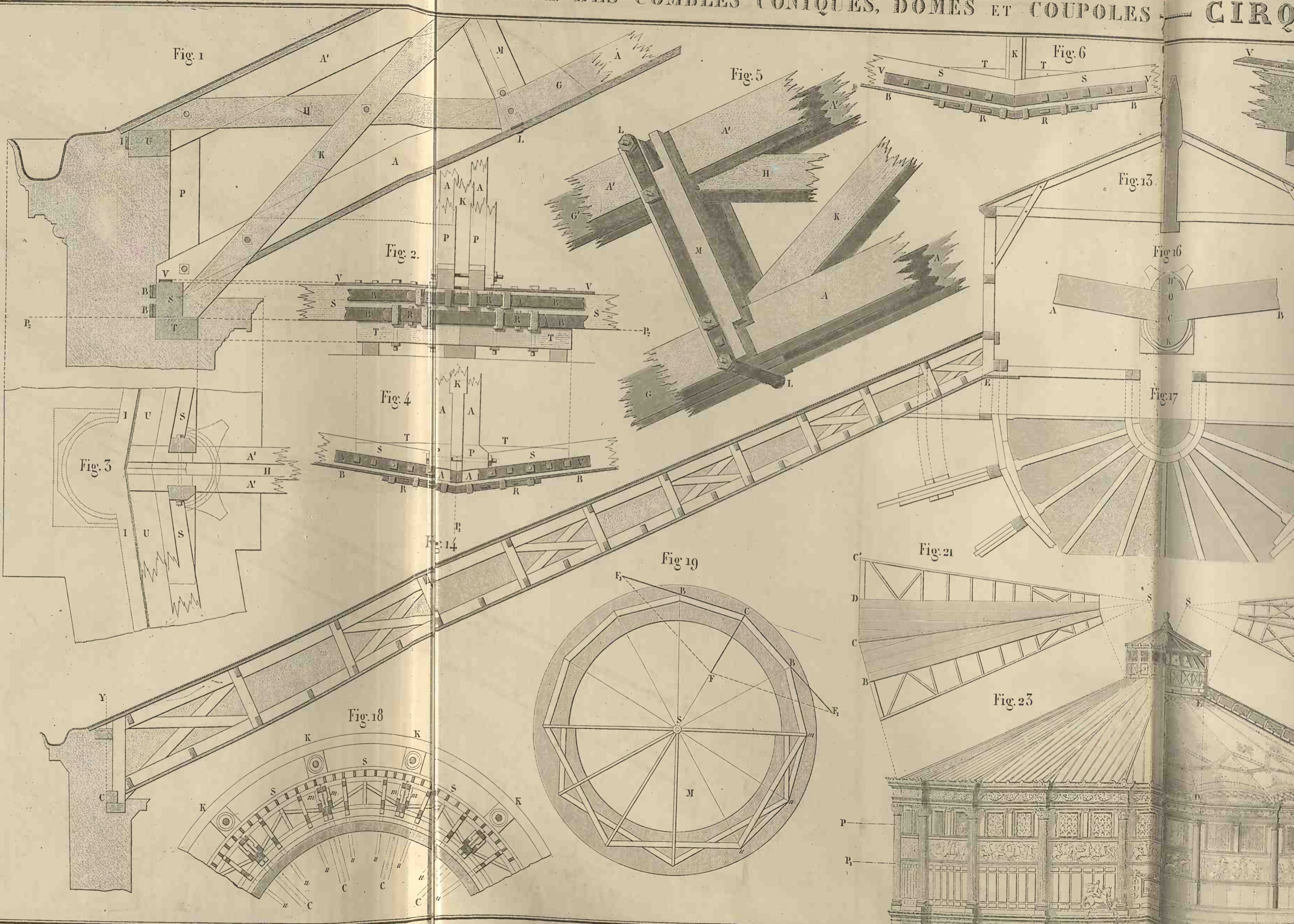

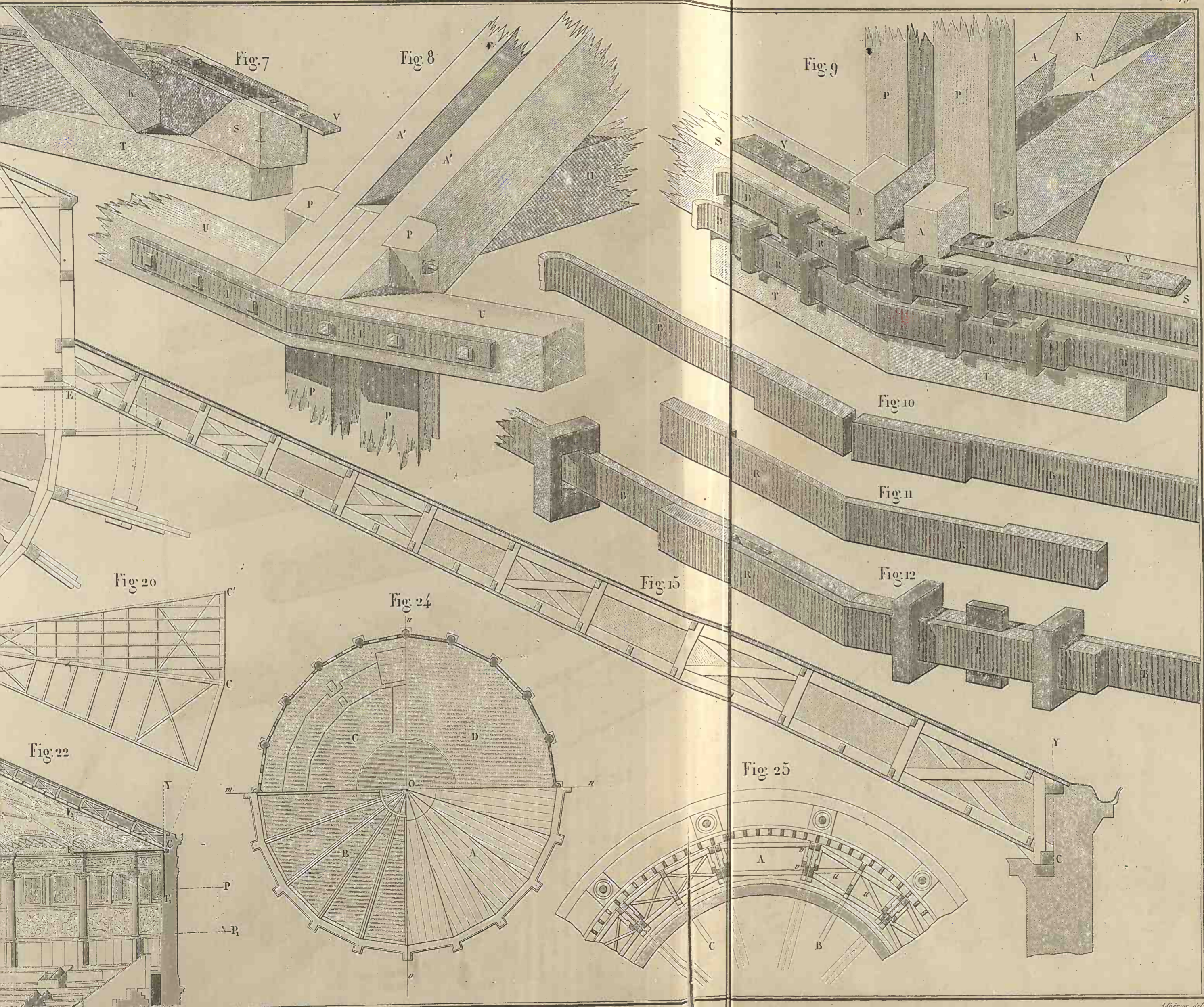

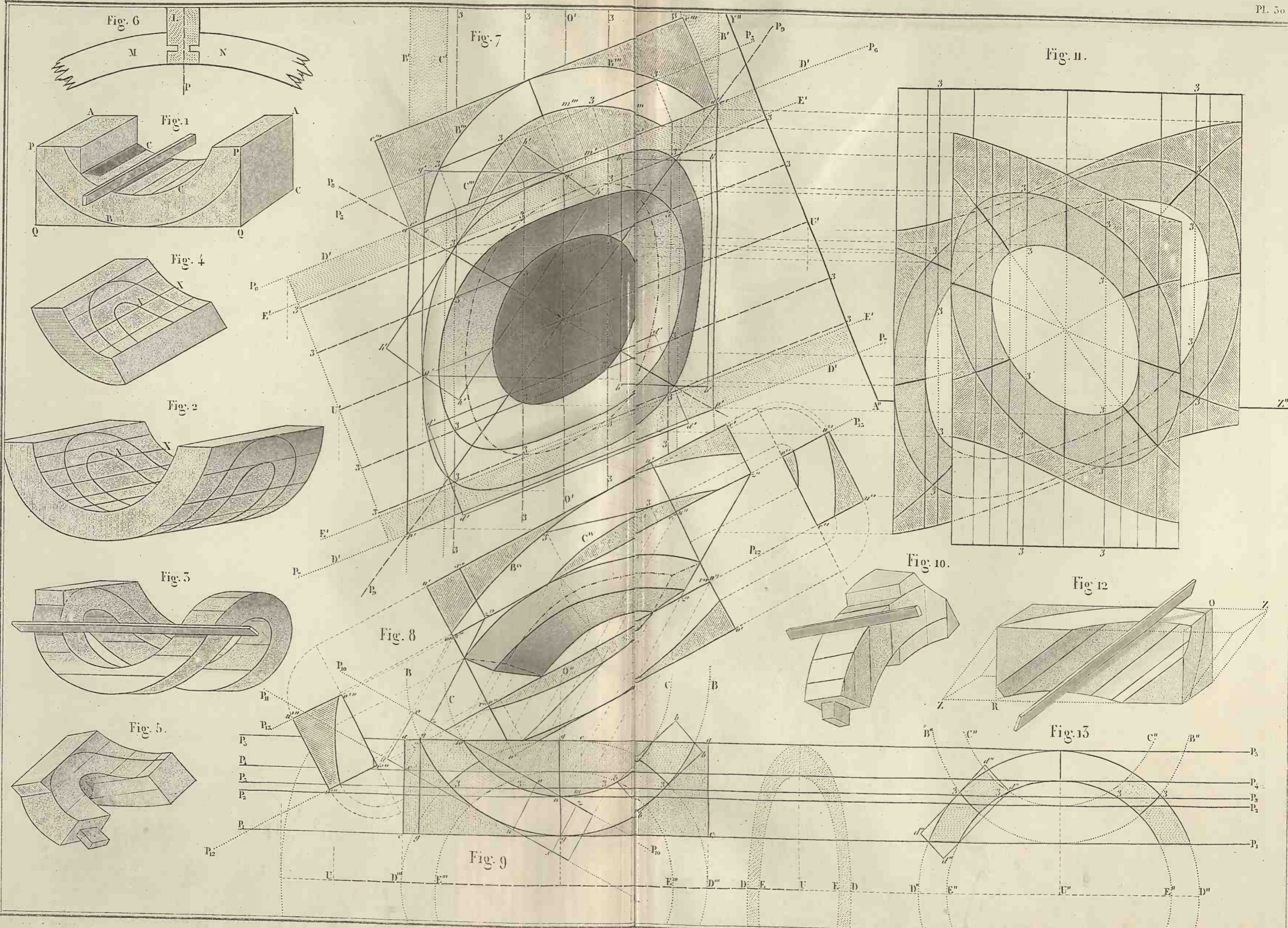

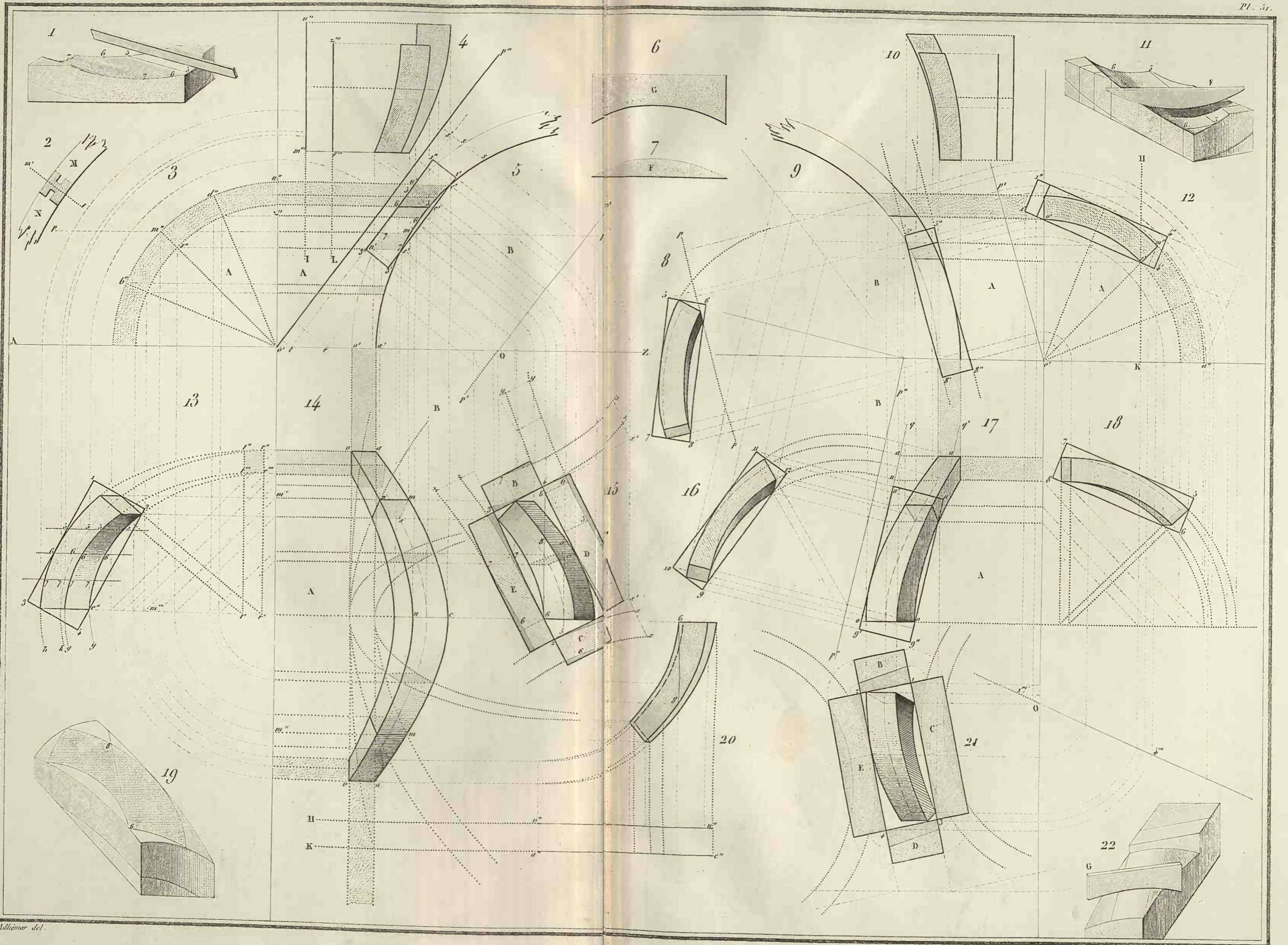

Pénétrations

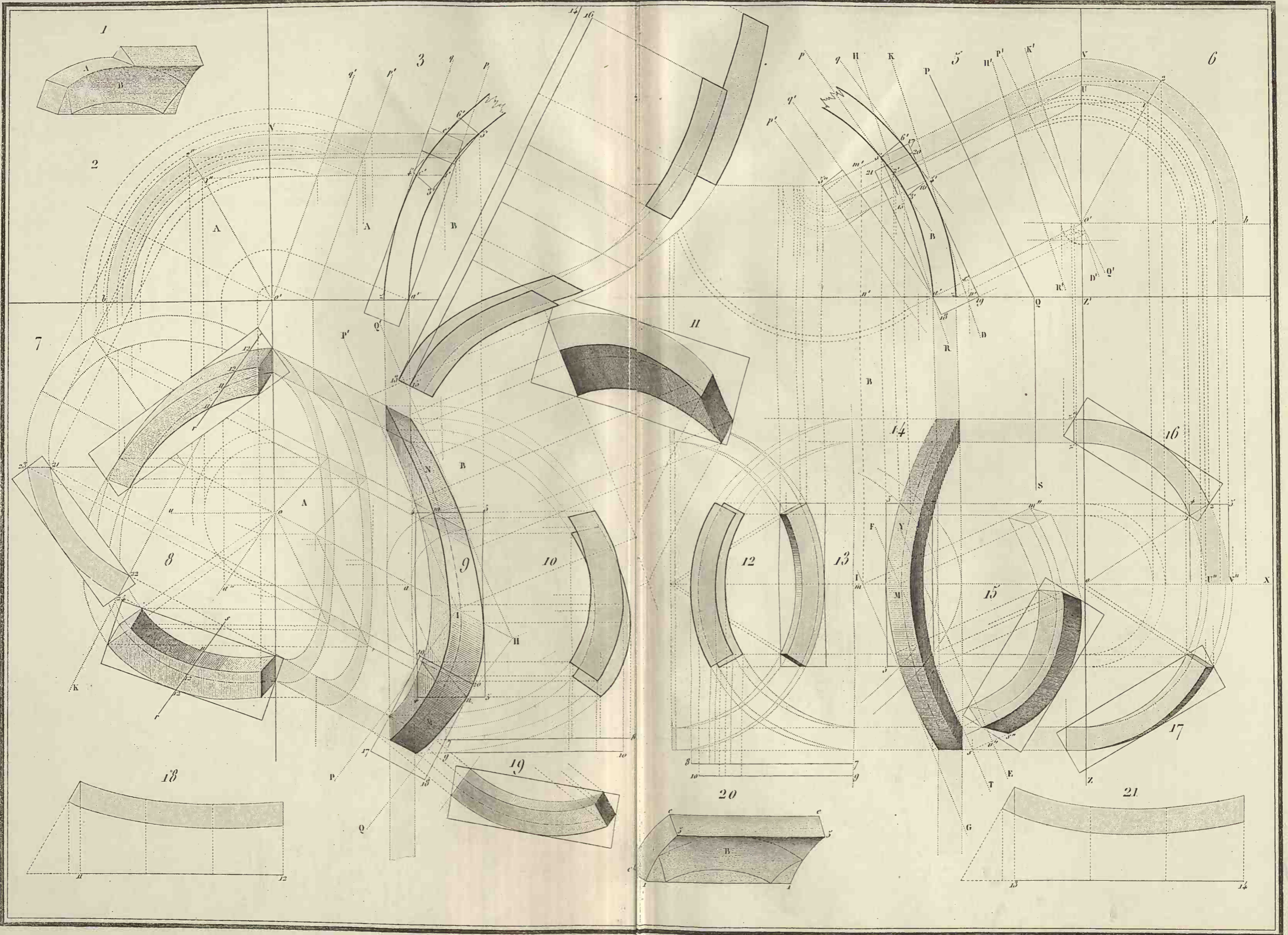

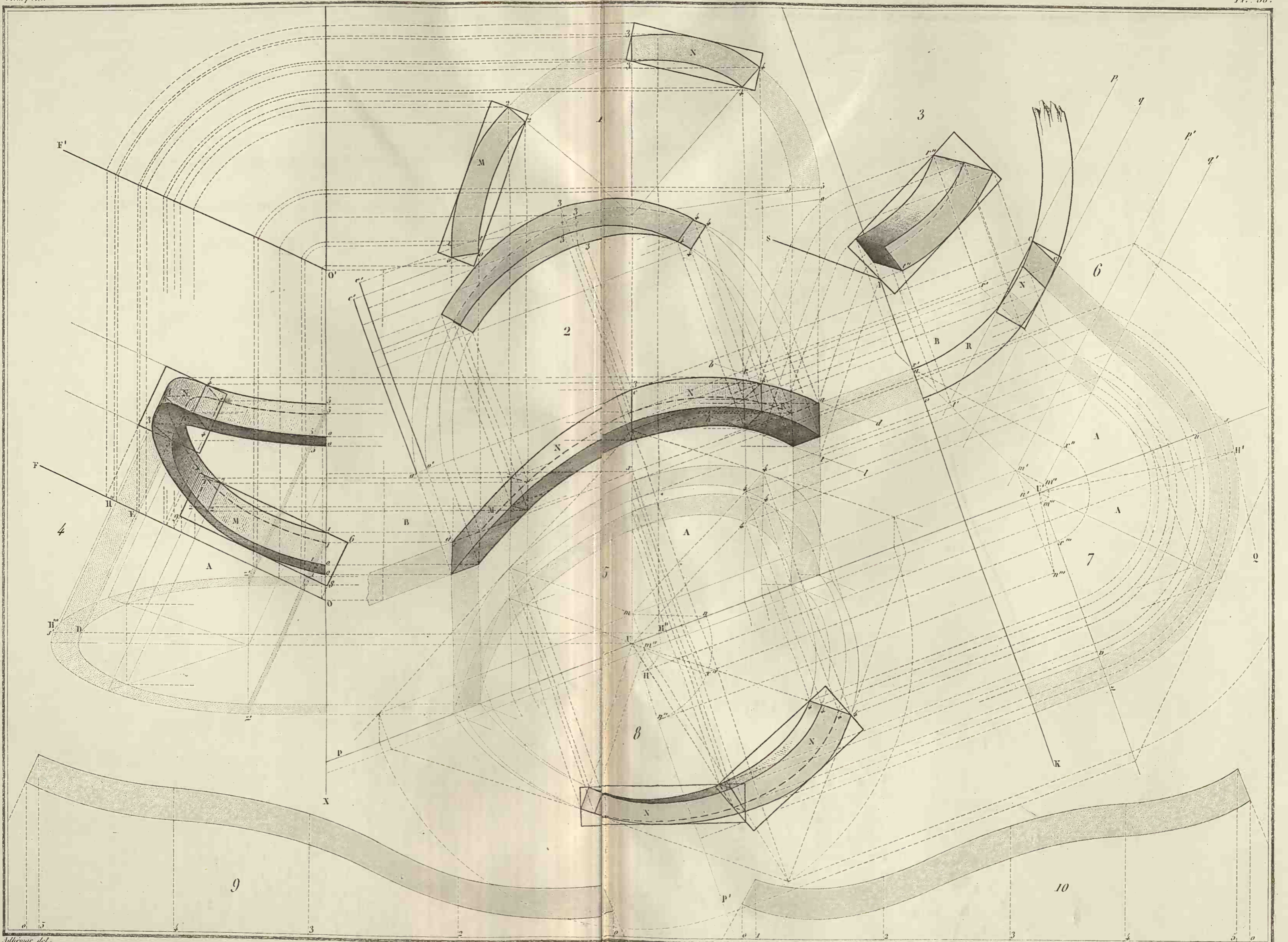

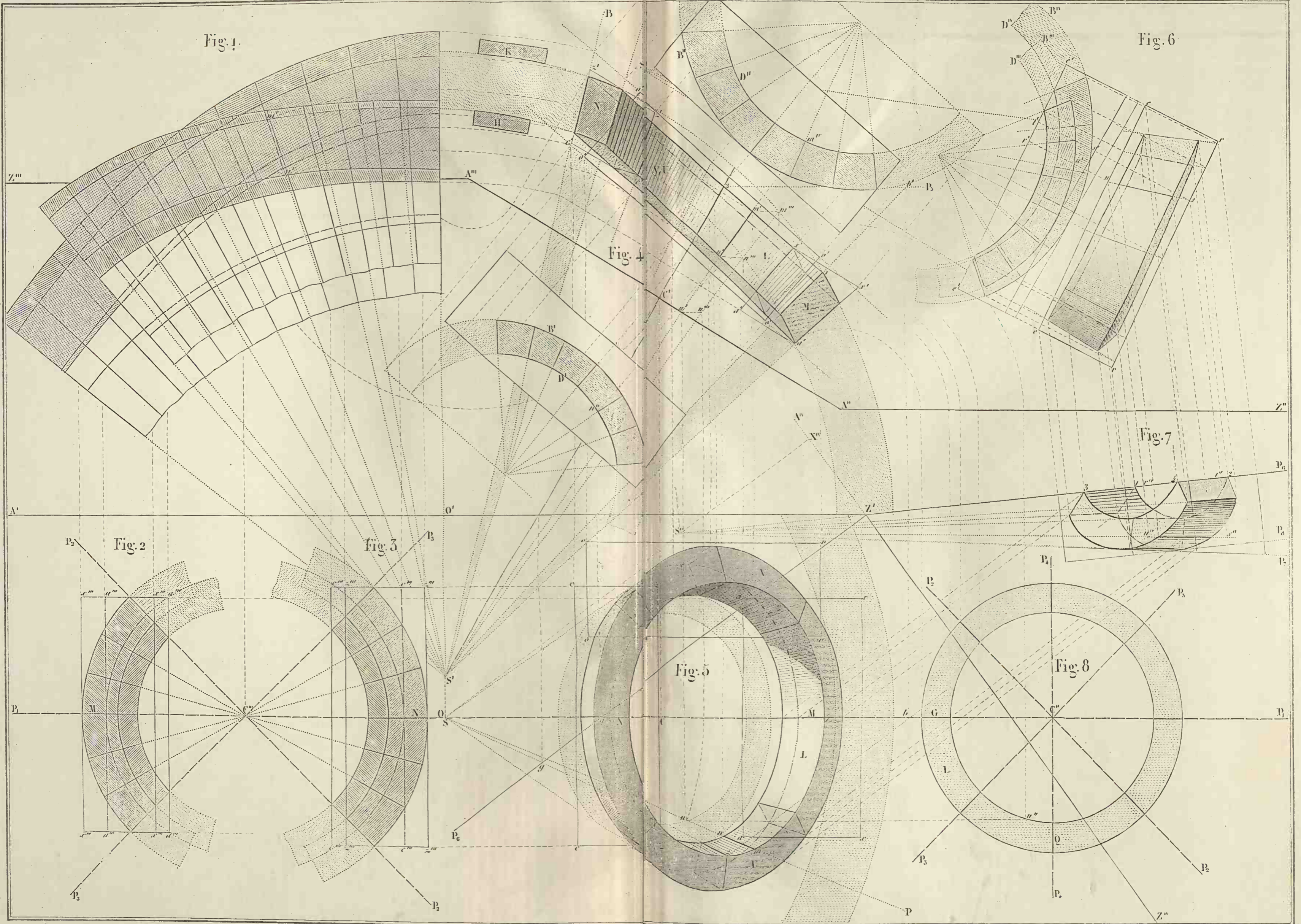

Courbes rampantes.

Charpente

Pl. 55.

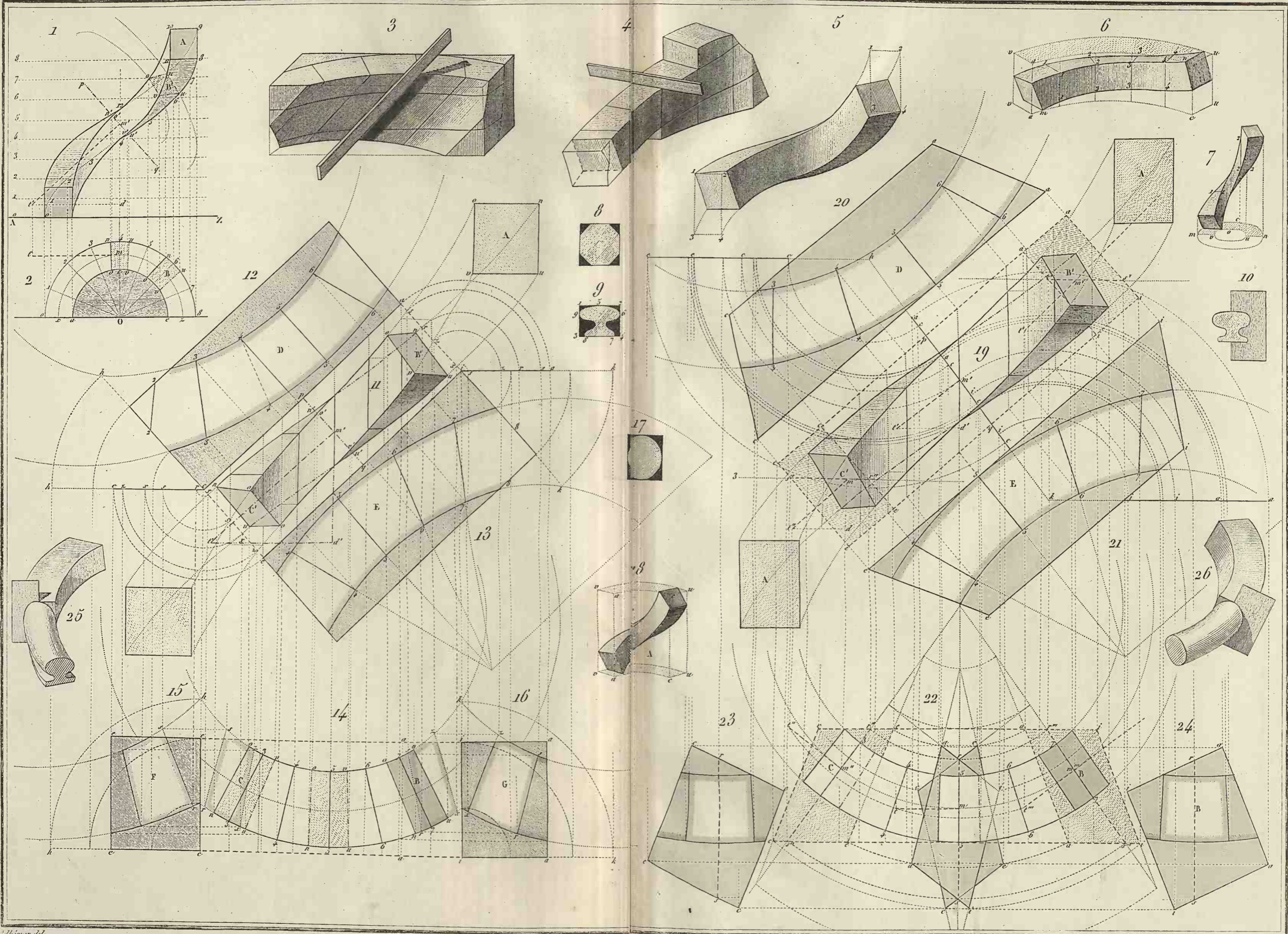

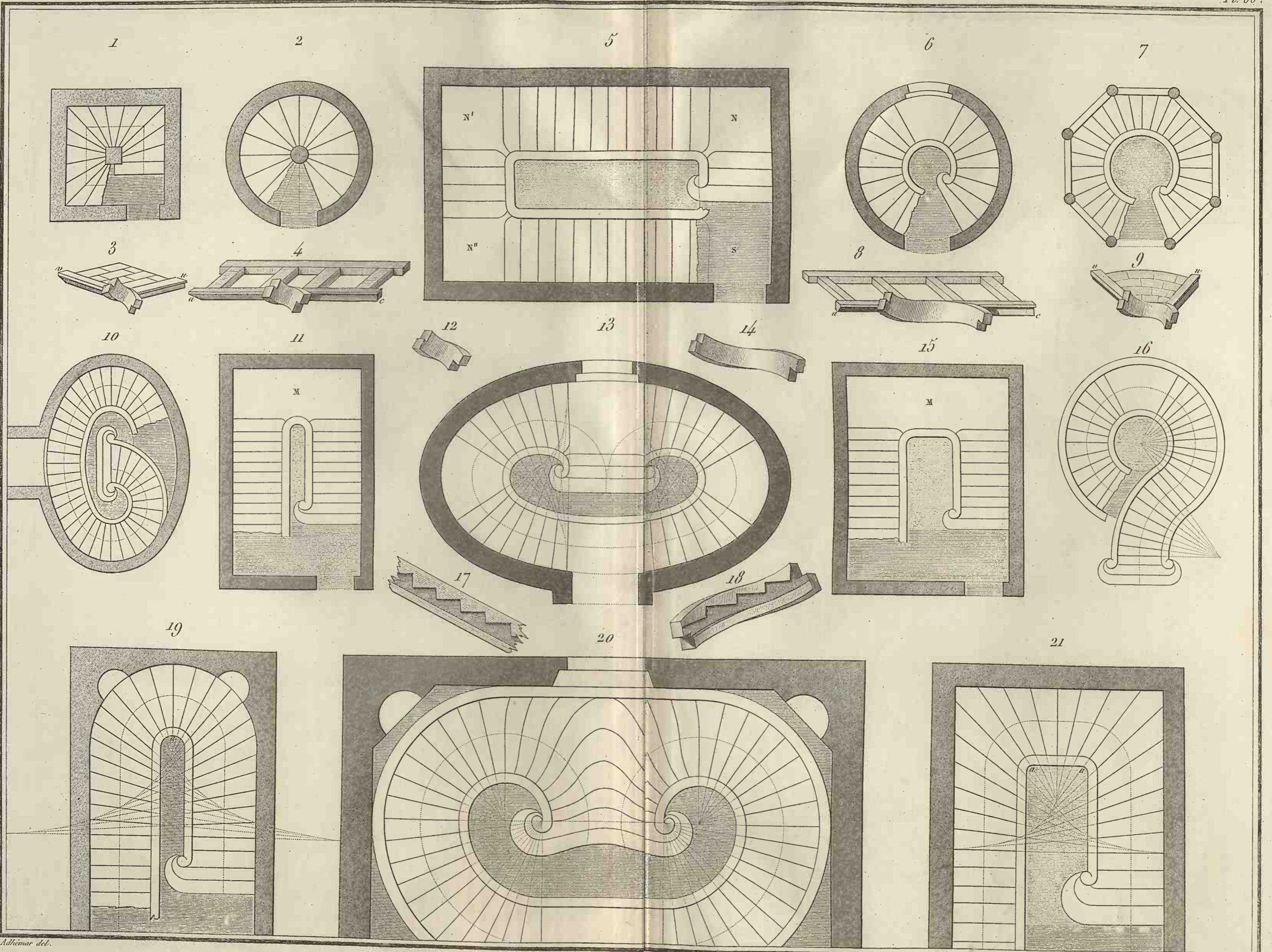

Escaliers

Charpente

Pl. 57

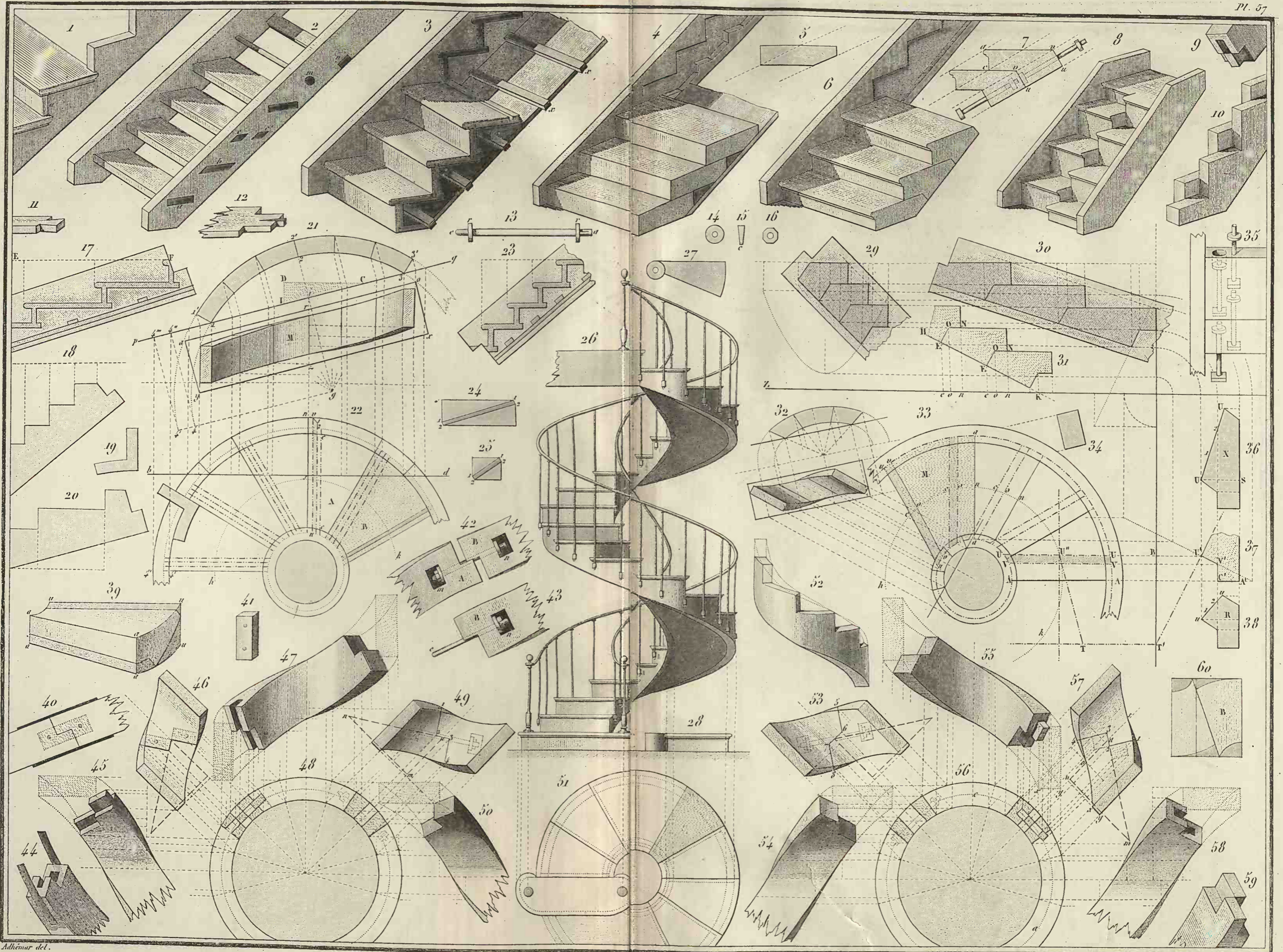

Adhémar del.

Dureau sc.

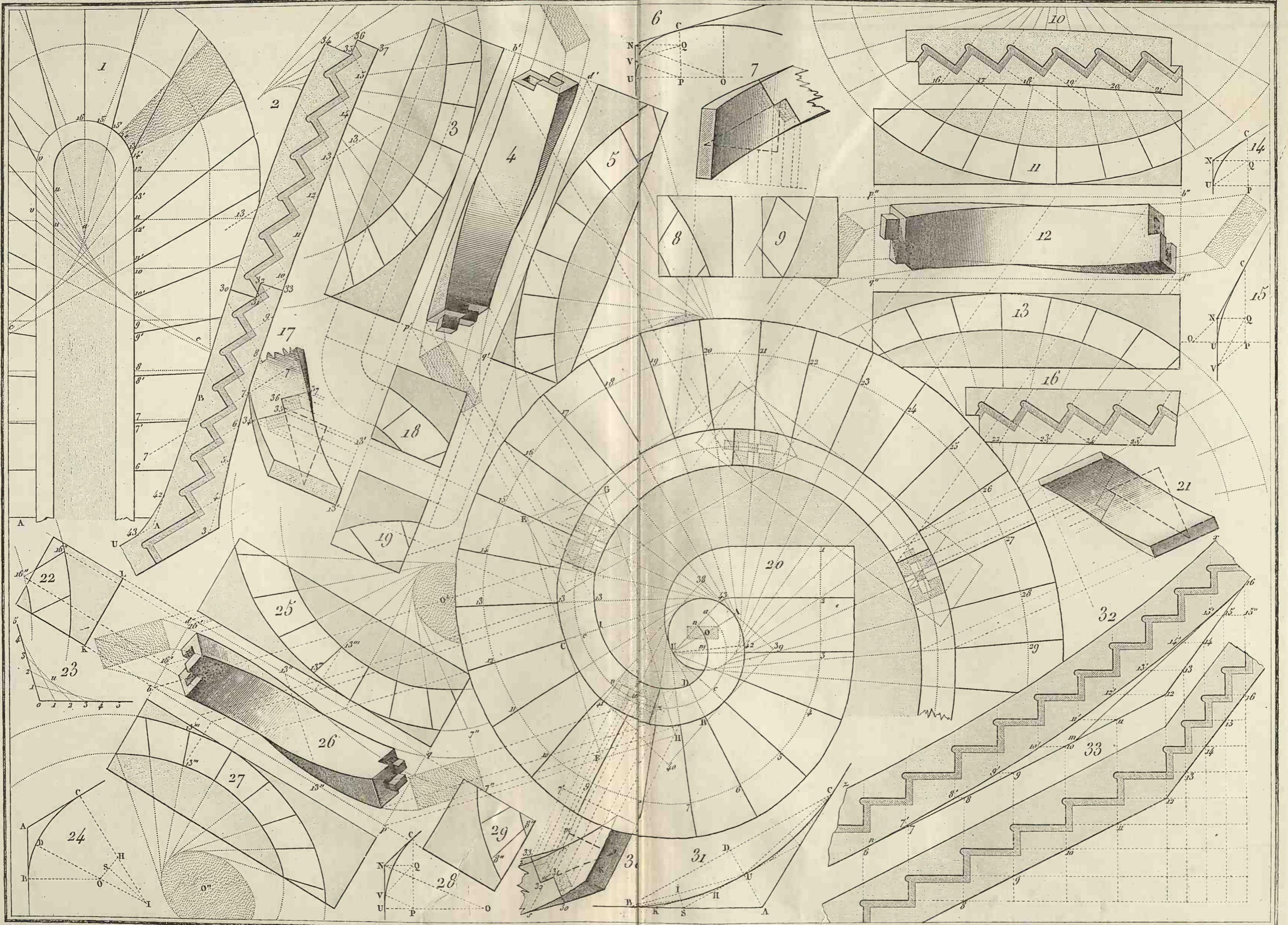

Escaliers.

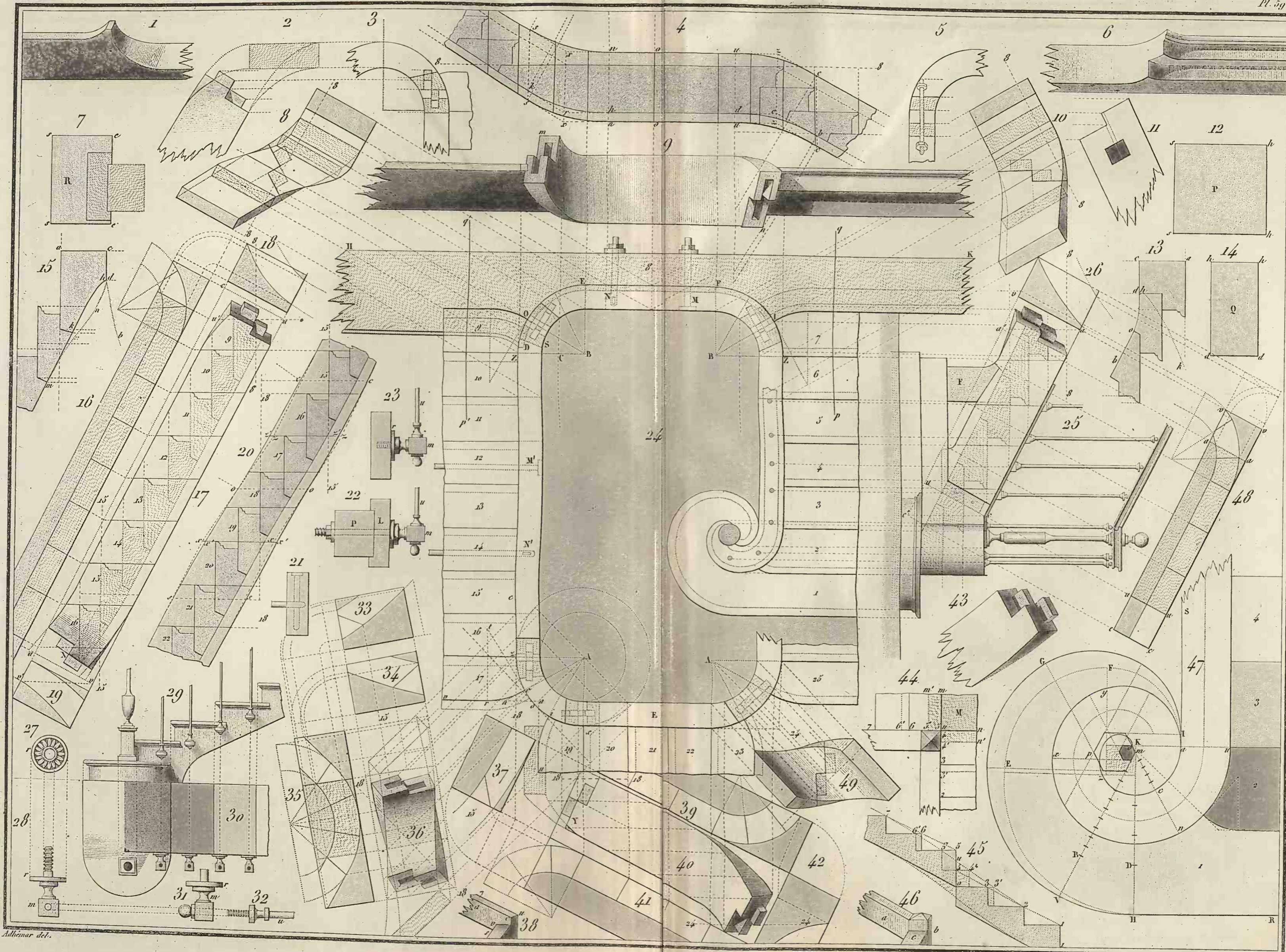

Escaliers

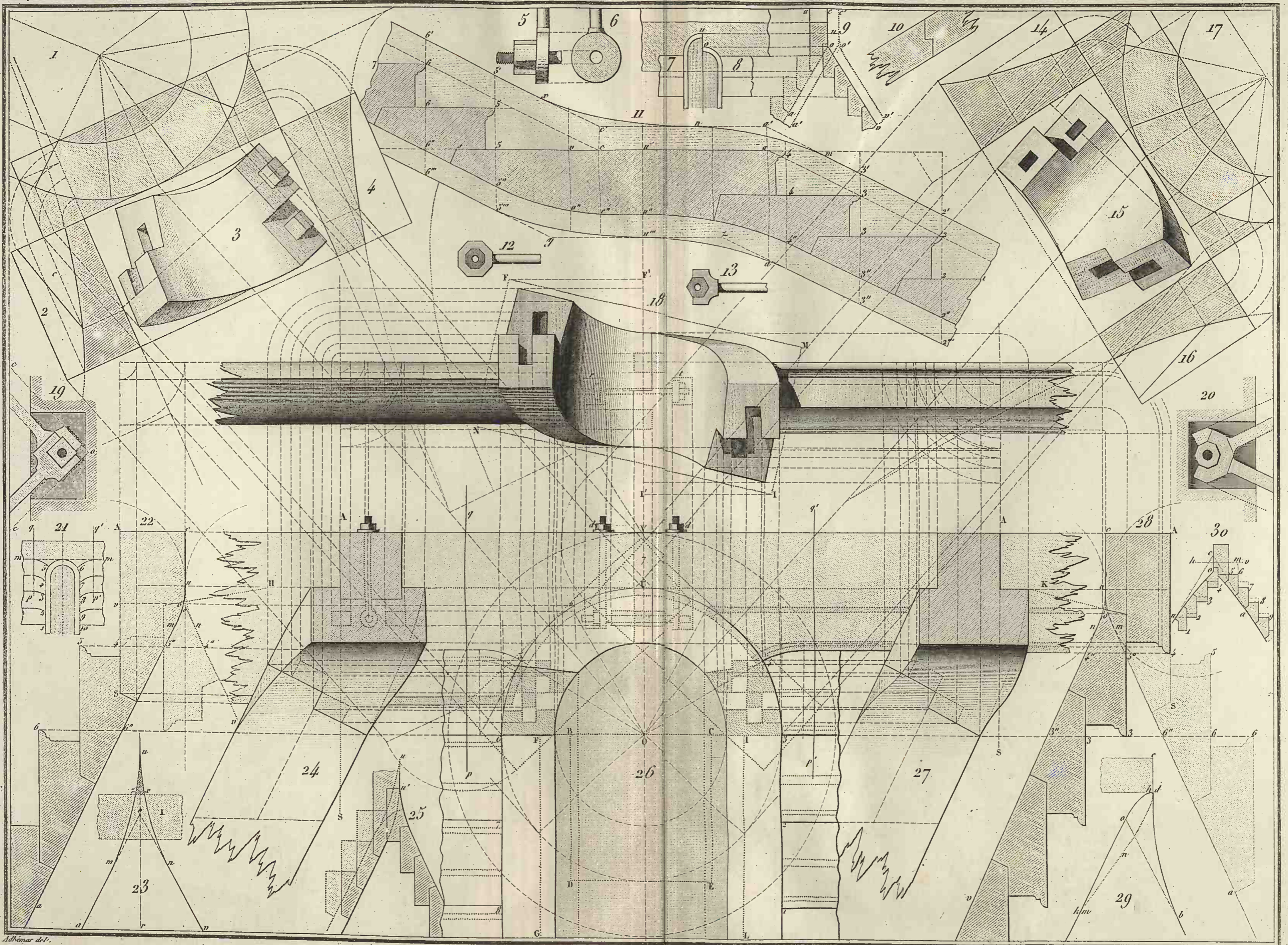

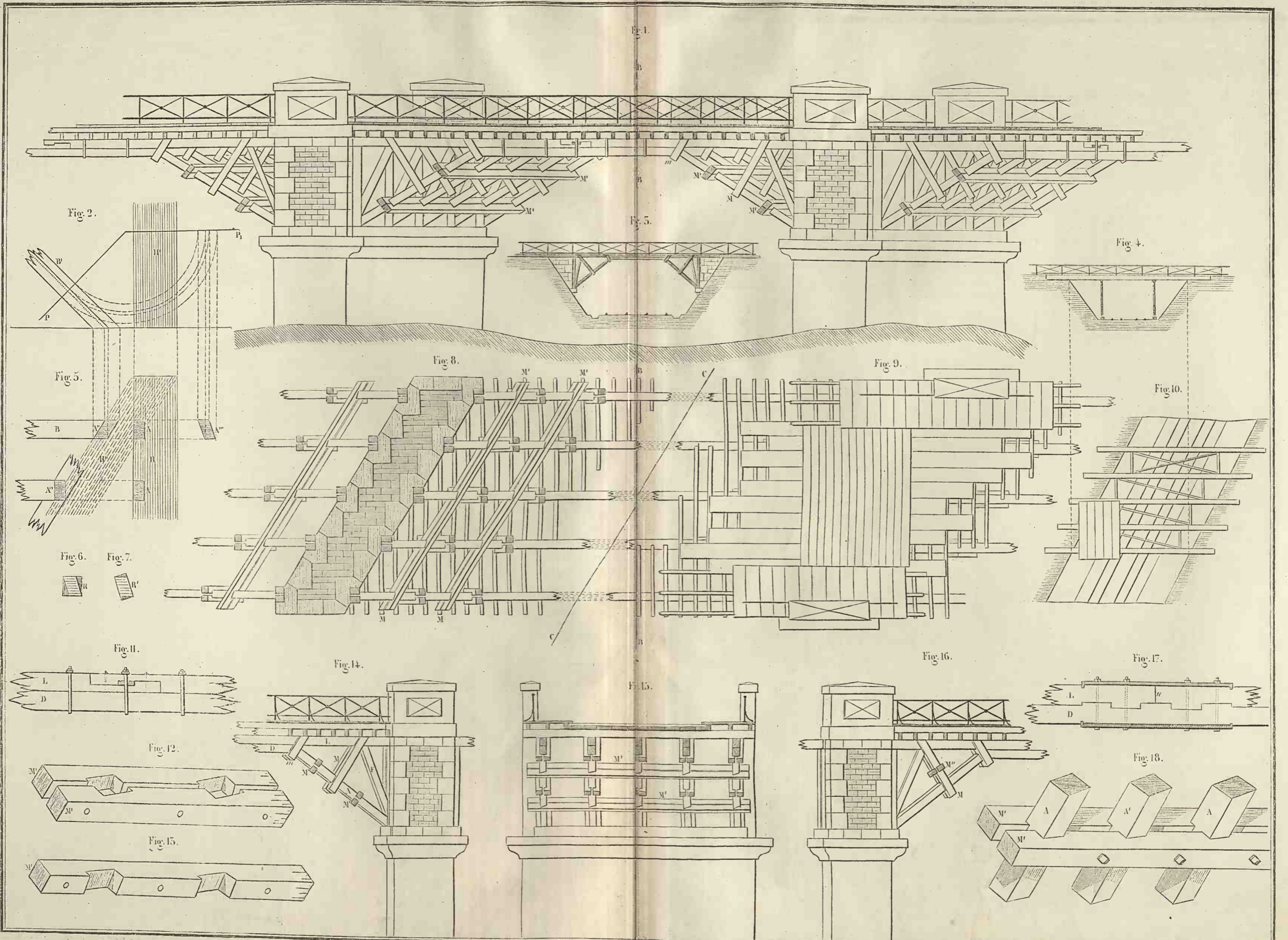

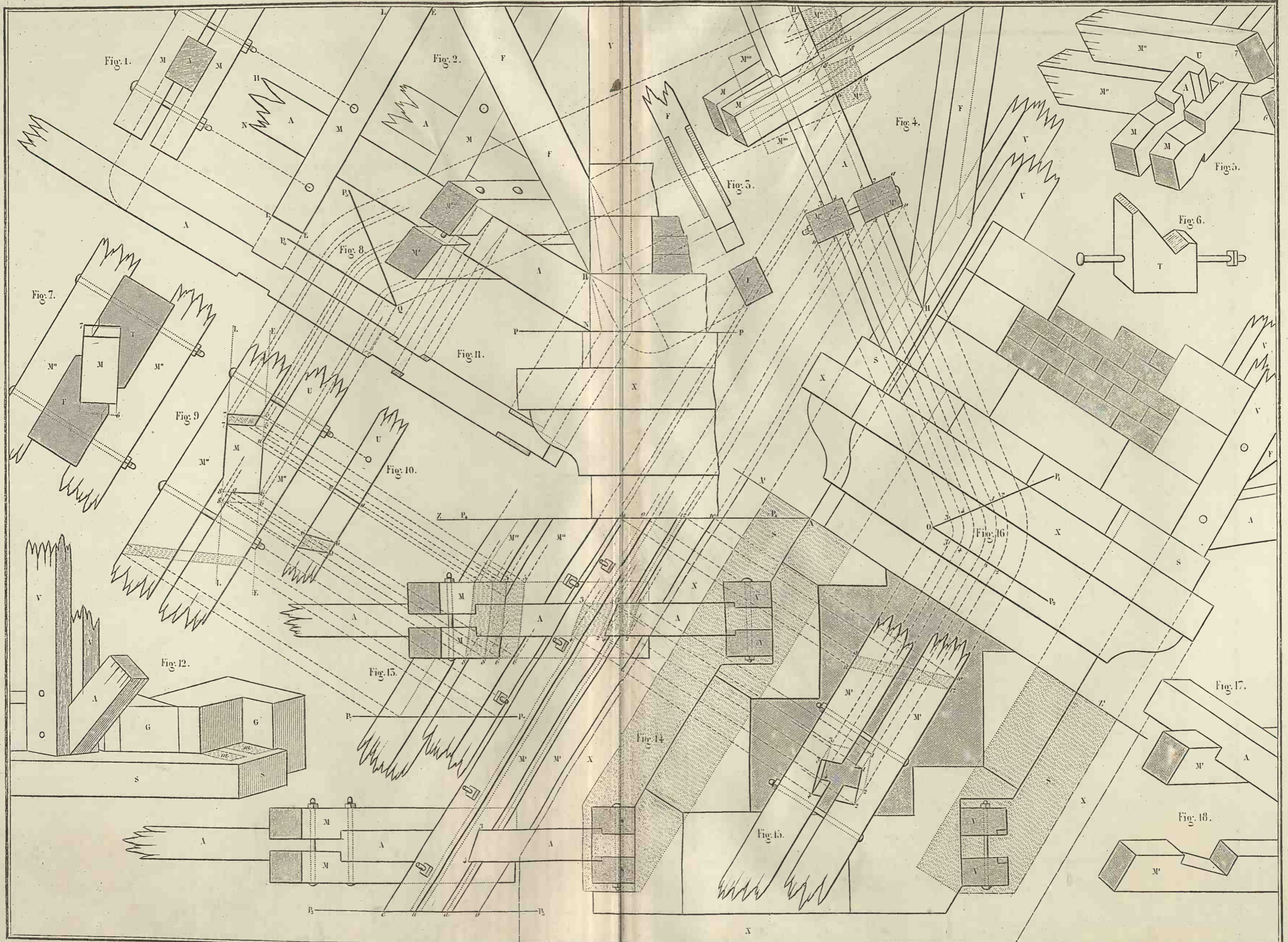

Fig. 1.

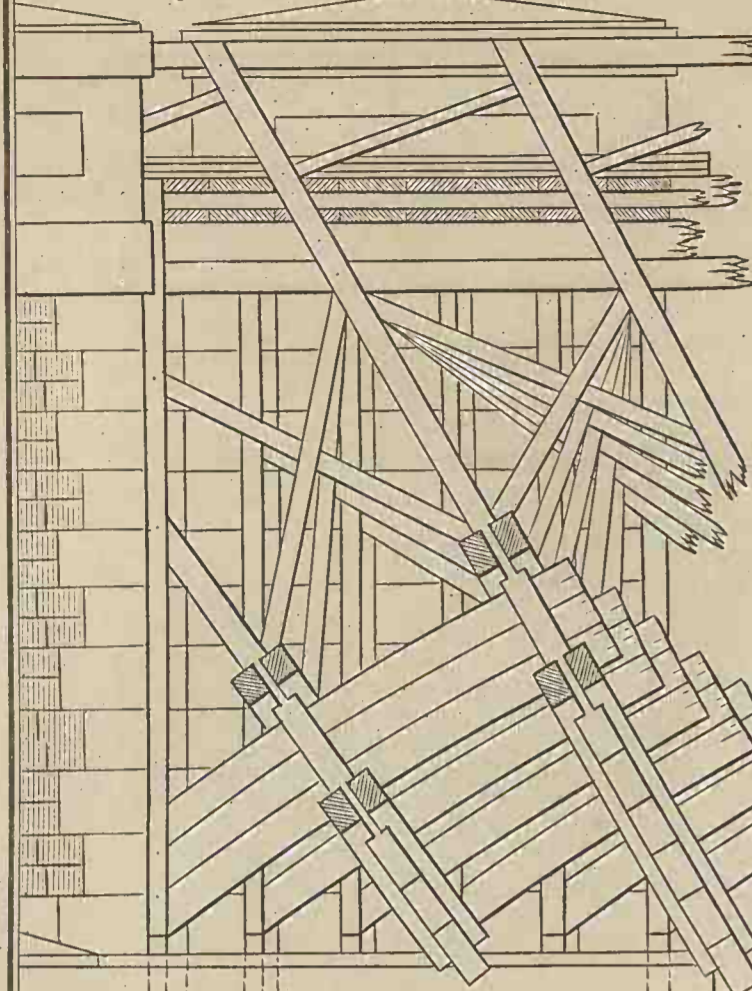

Fig. 4.

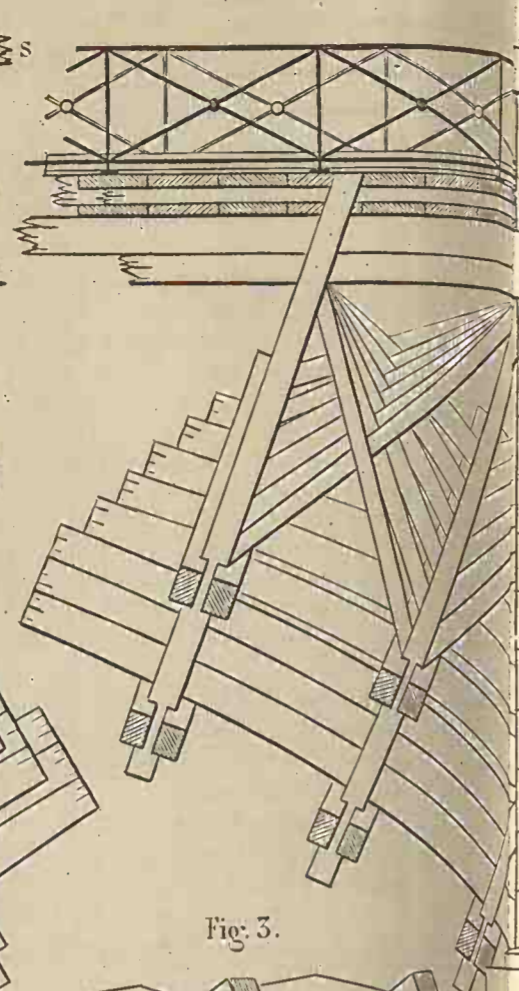

Fig. 2.



Fig. 3.

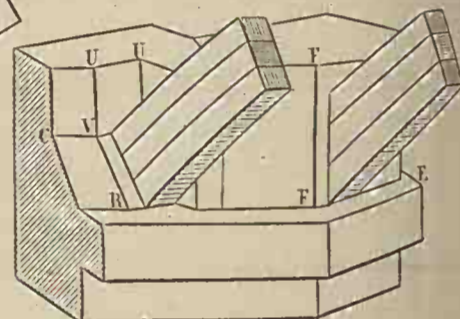

Fig. 14.

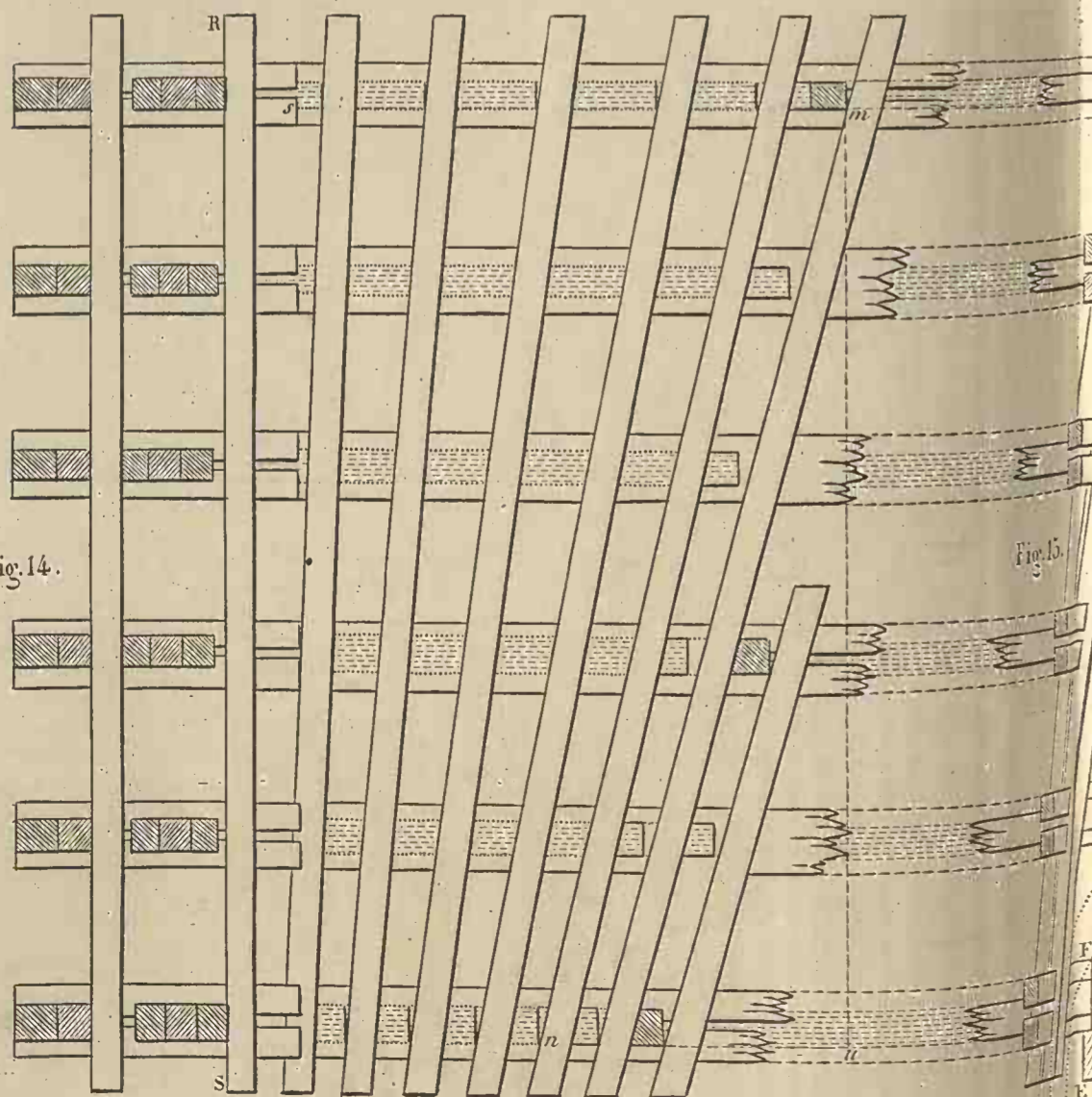

Fig. 15.

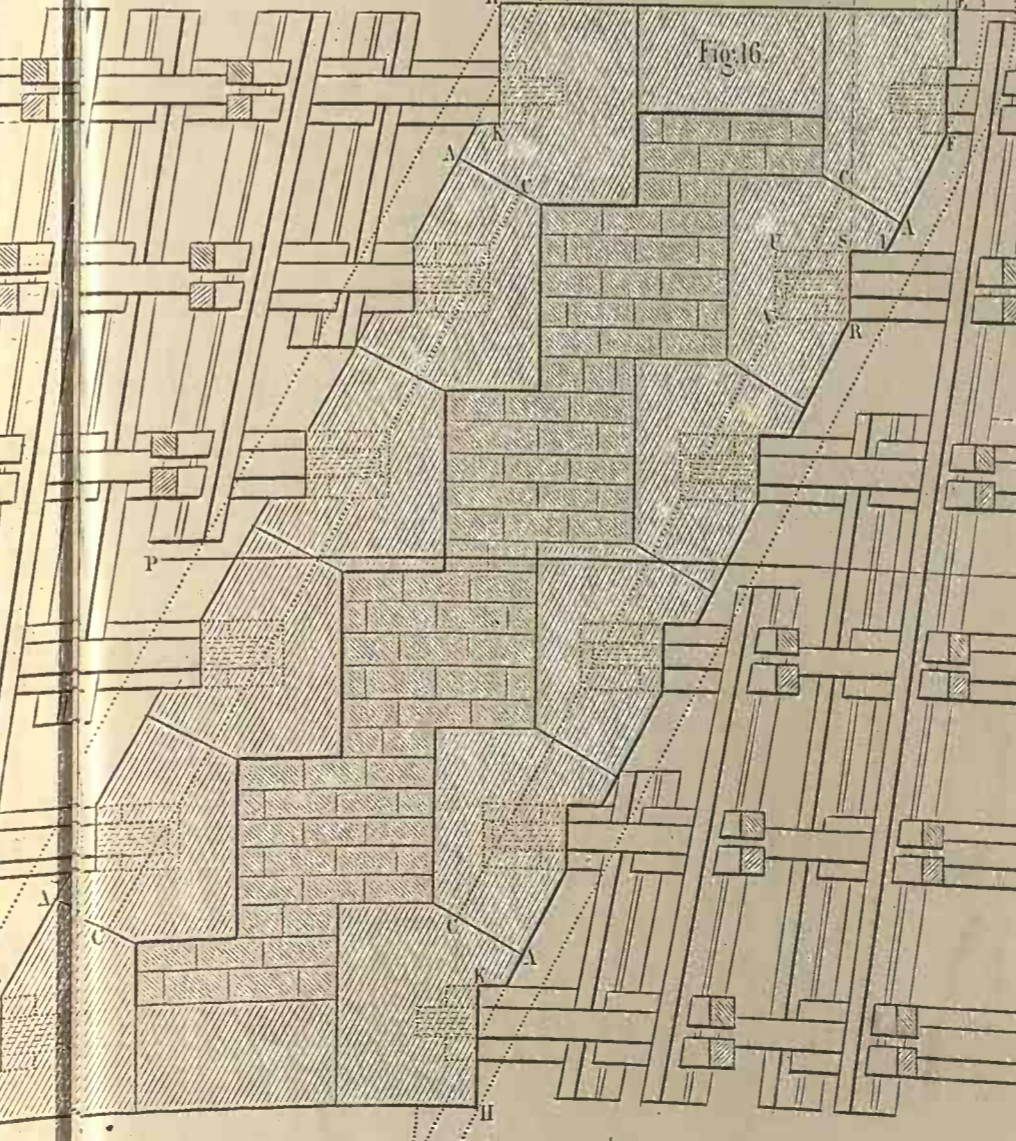

Fig. 16.

Fig. 17.

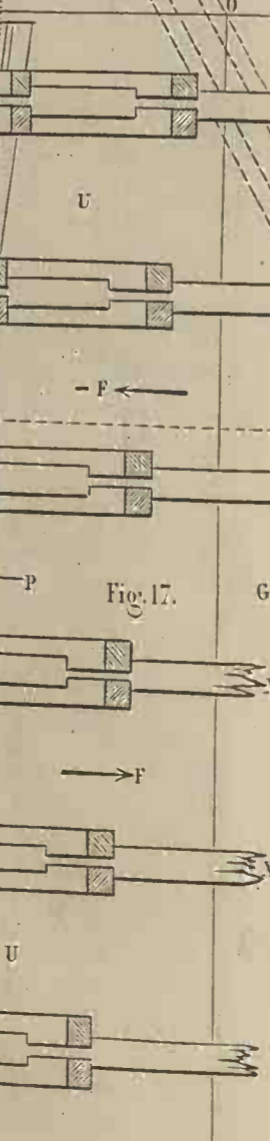

Fig. 19.

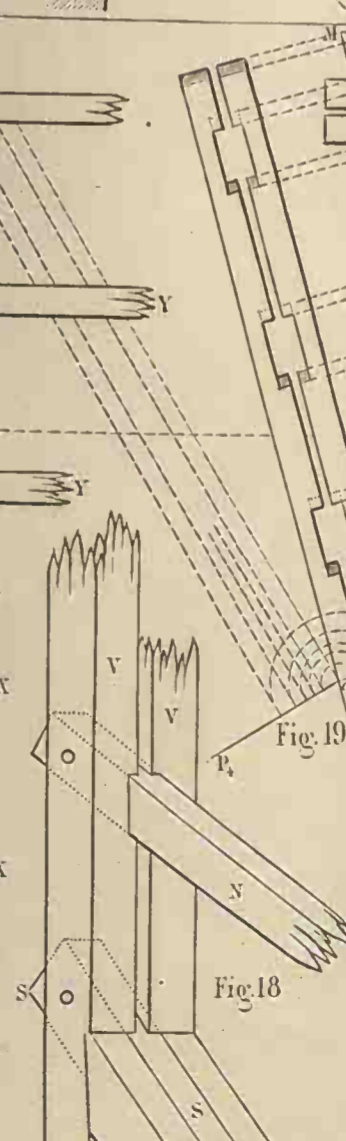

Fig. 18.

Fig. 5.

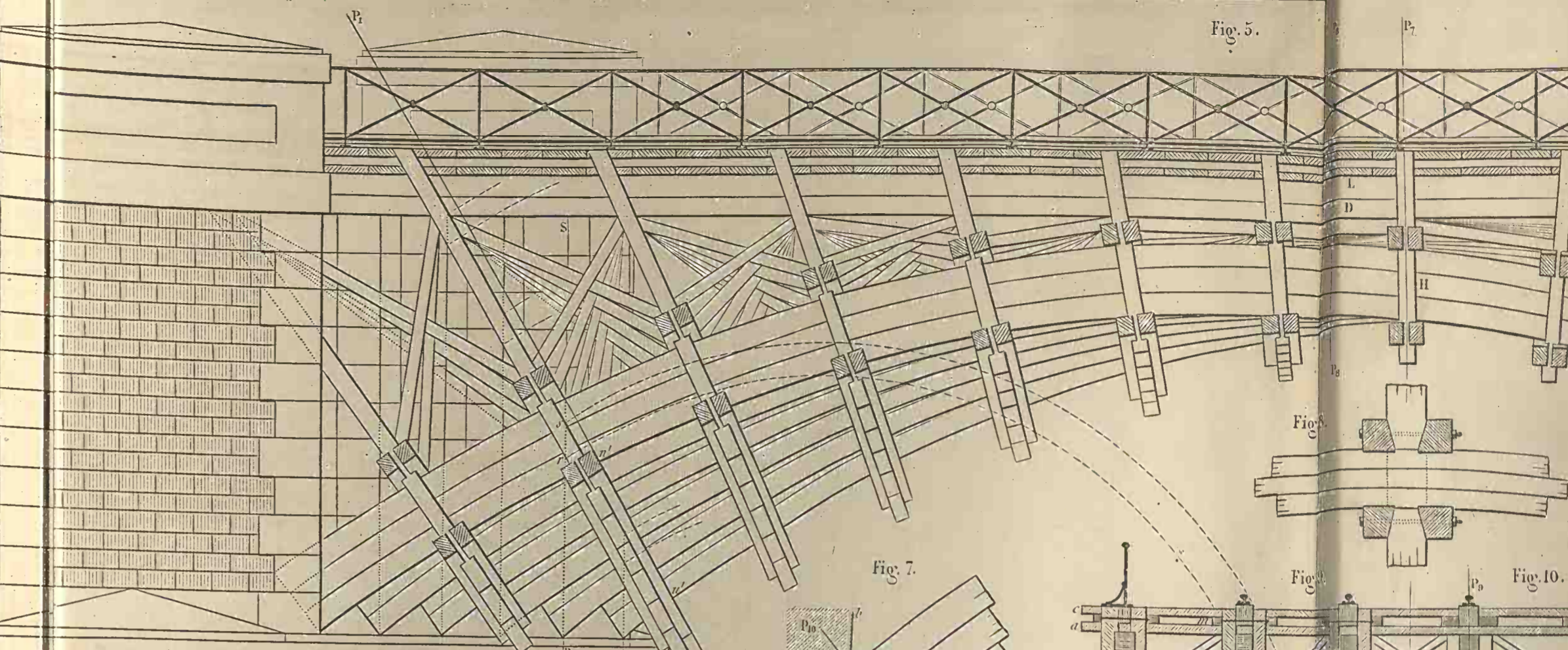

Fig. 6.

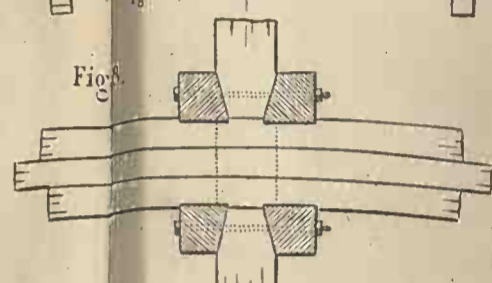

Fig. 9.

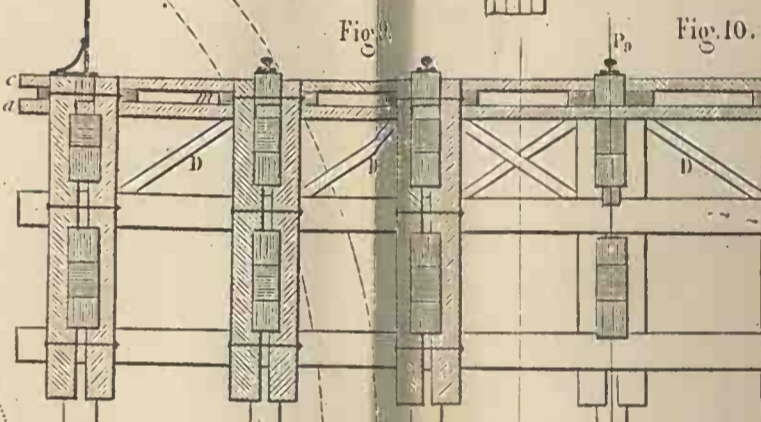
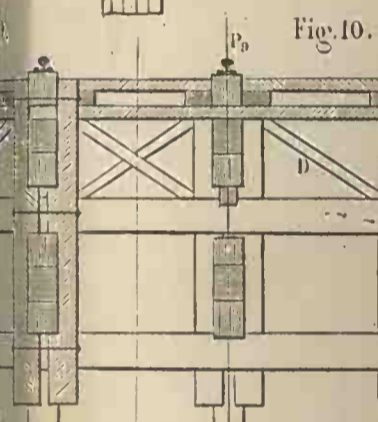
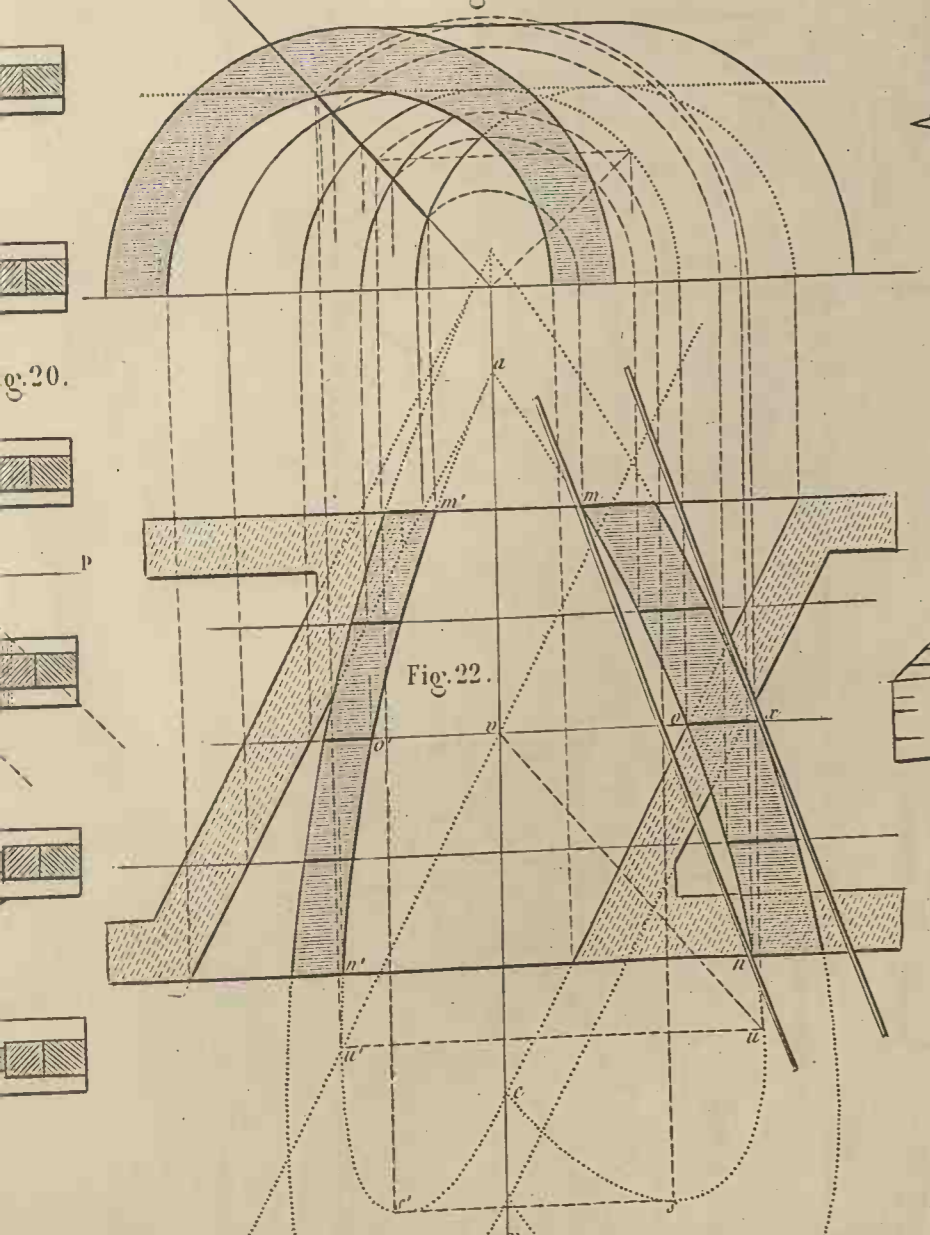
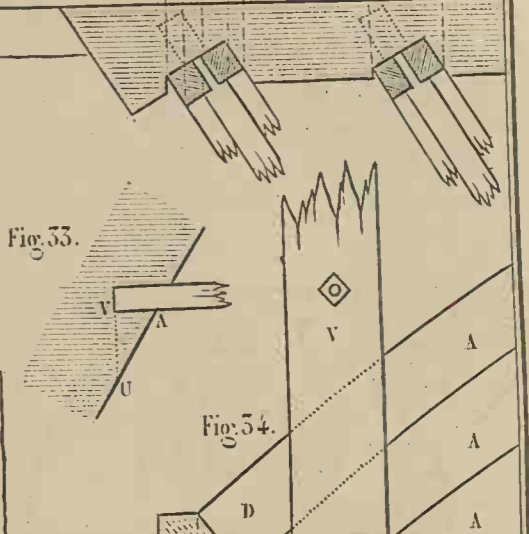
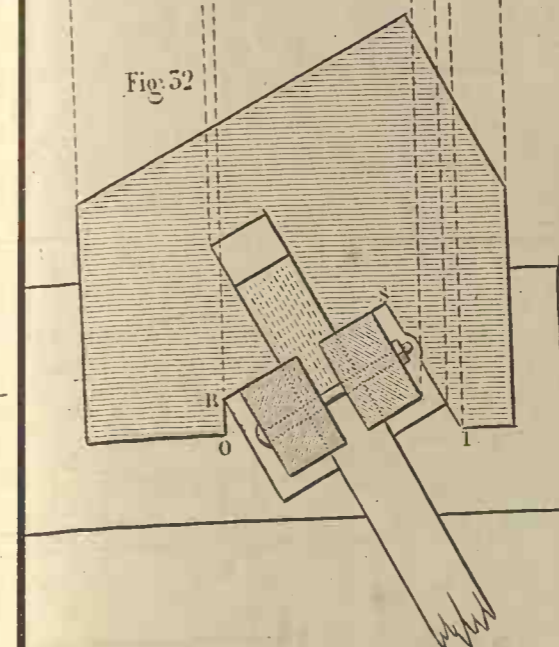
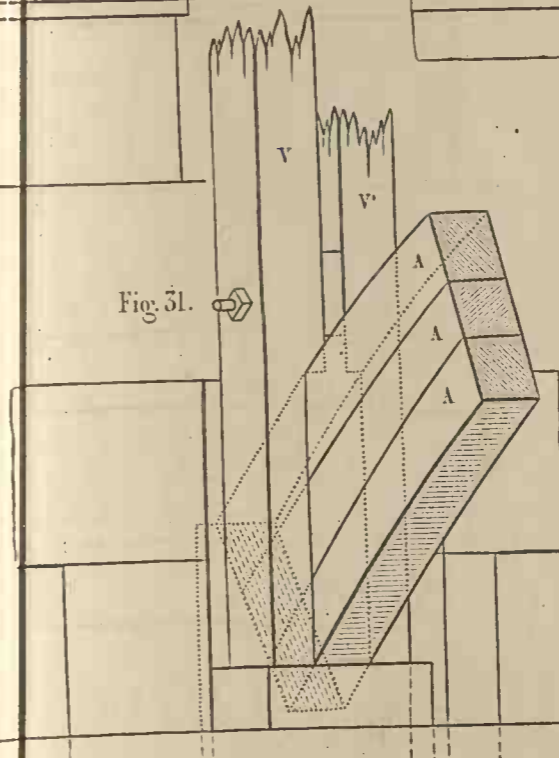
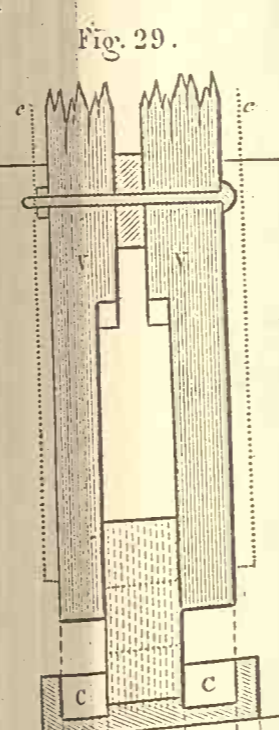
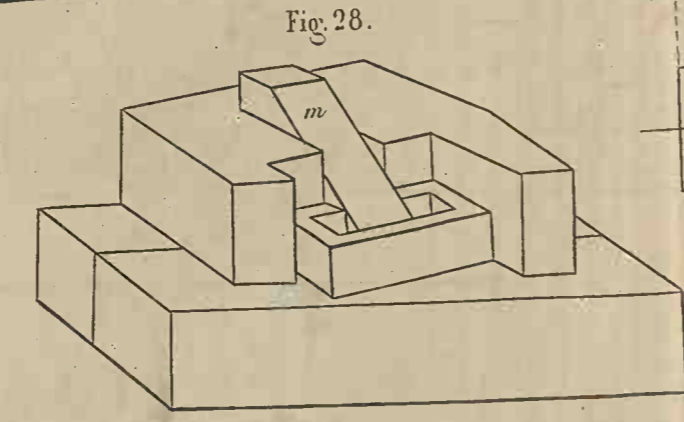
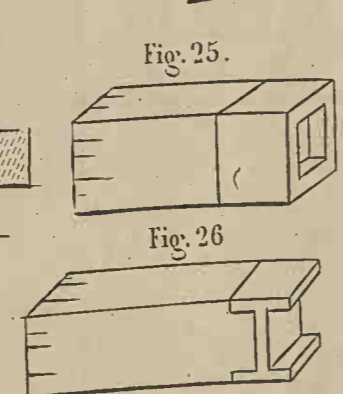
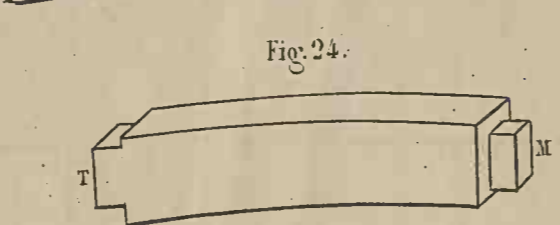
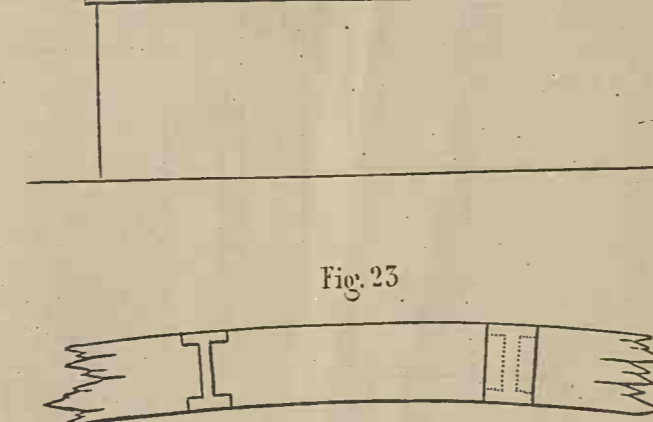
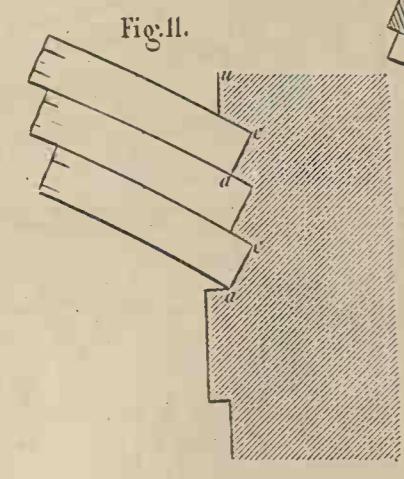
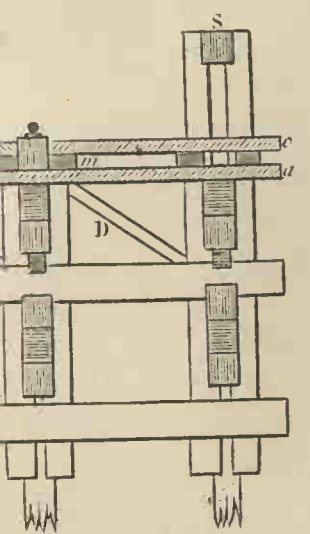
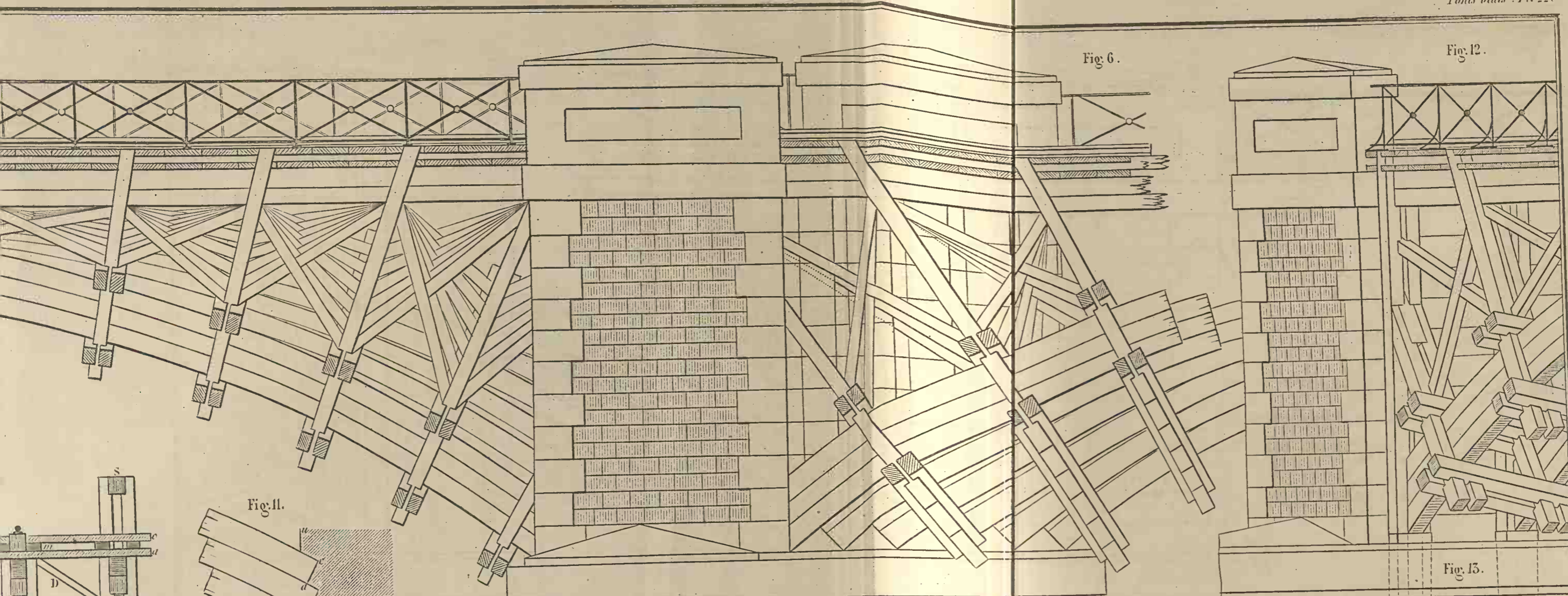

Fig. 10.





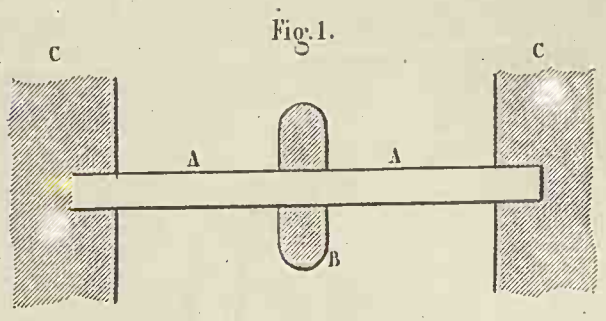

Fig. 1.

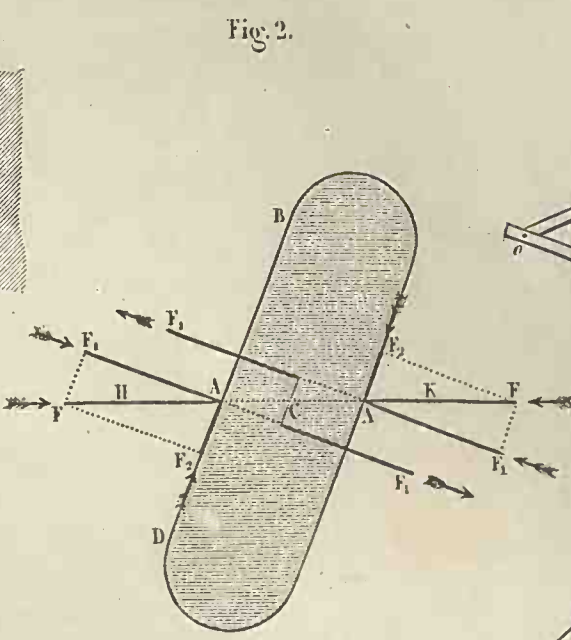

Fig. 2.

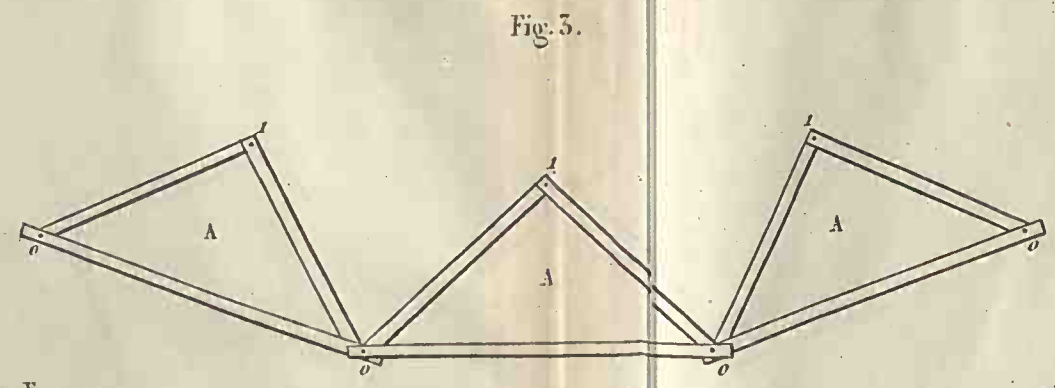

Fig. 3.

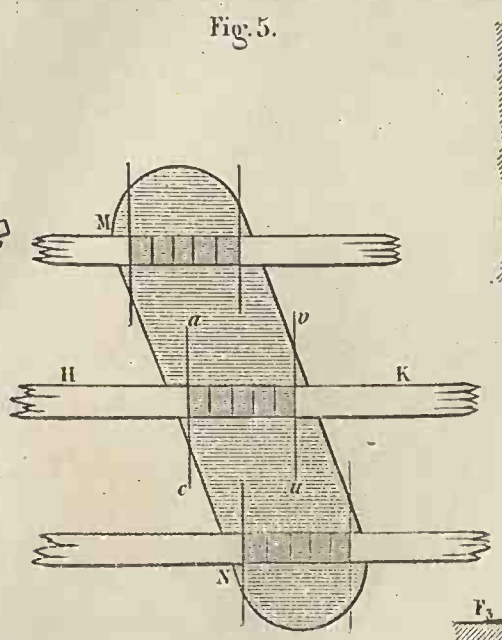

Fig. 5.

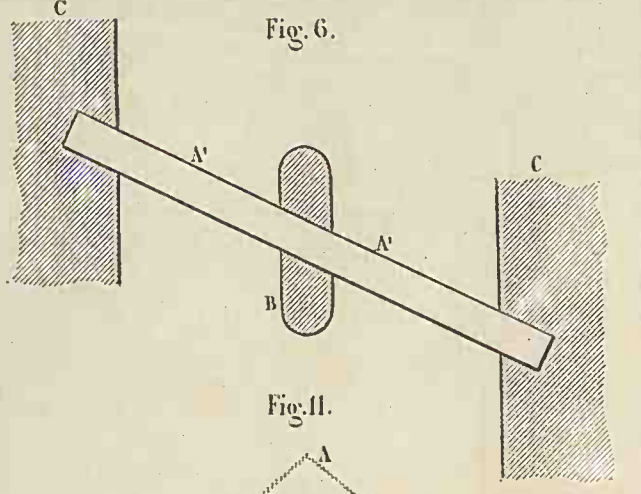

Fig. 6.

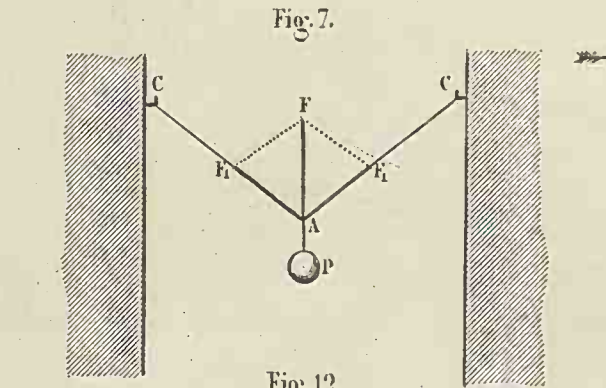

Fig. 7.

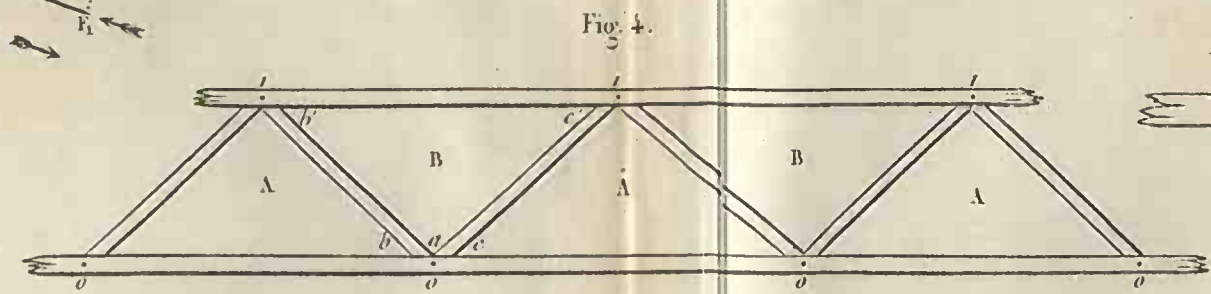

Fig. 4.

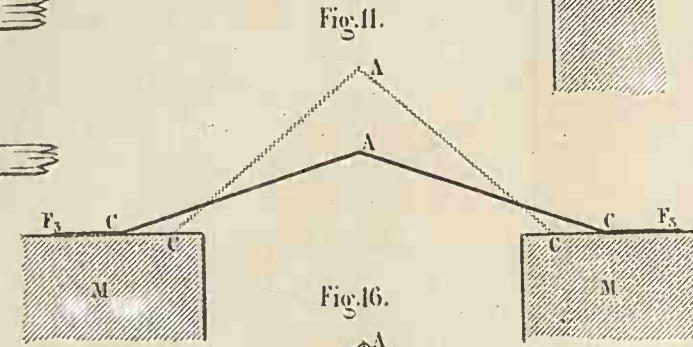

Fig. 11.

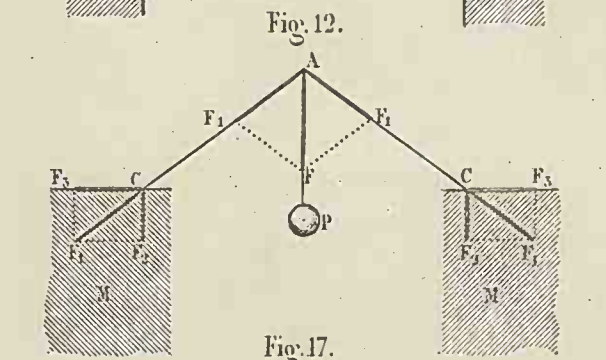

Fig. 12.

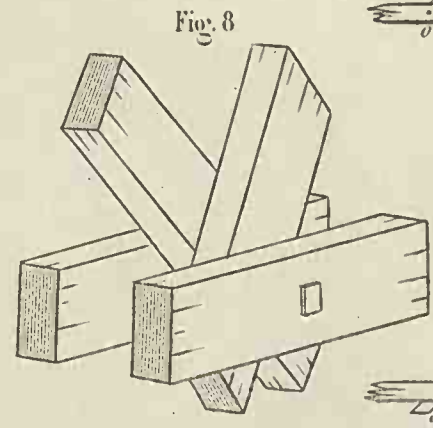

Fig. 8.

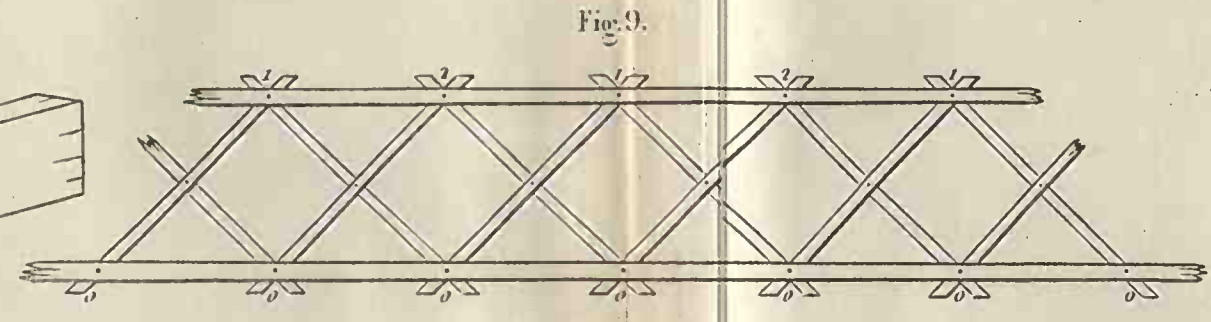

Fig. 9.

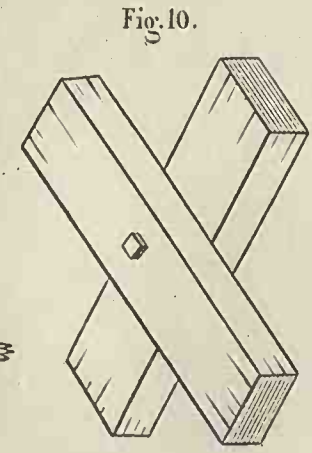

Fig. 10.

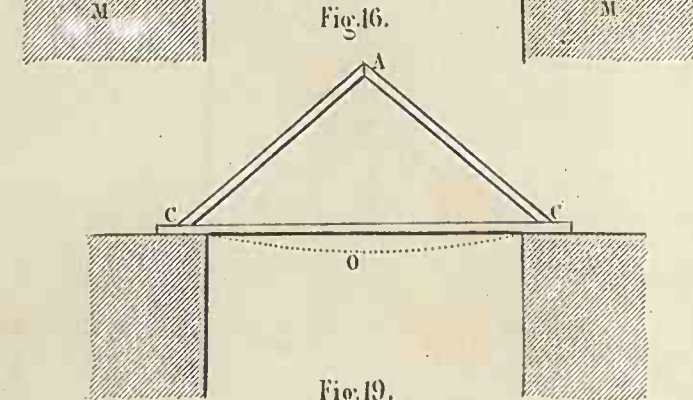

Fig. 16.

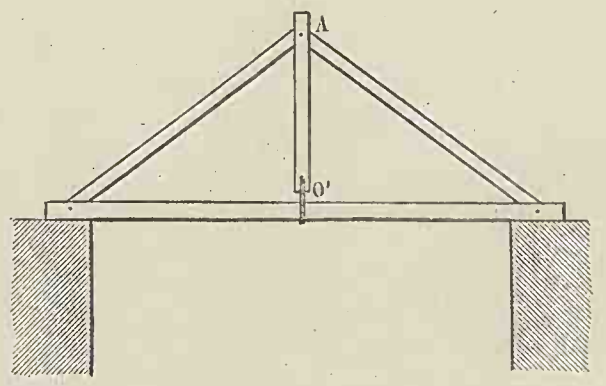

Fig. 17.

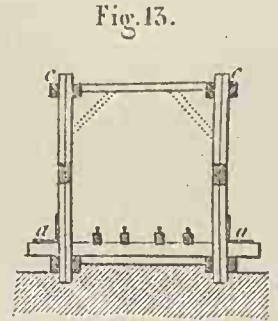

Fig. 13.

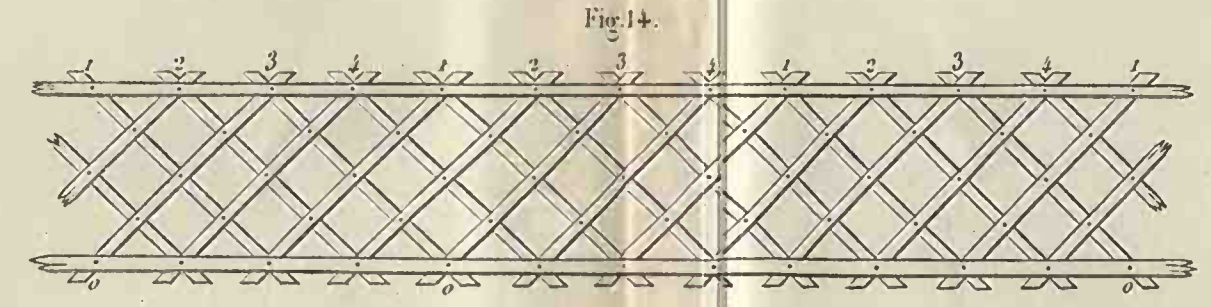

Fig. 14.

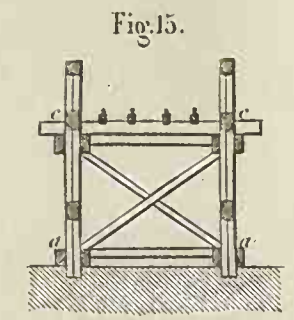

Fig. 15.

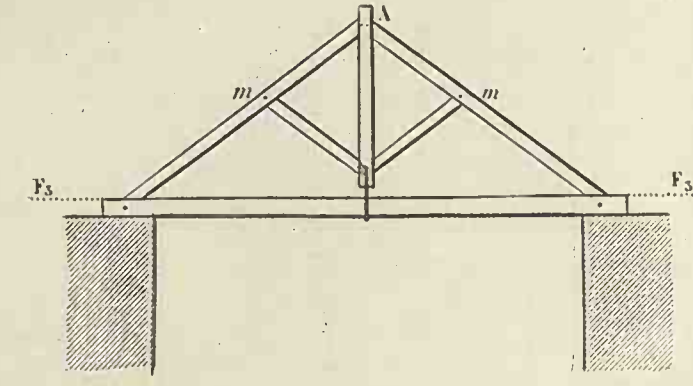

Fig. 19.

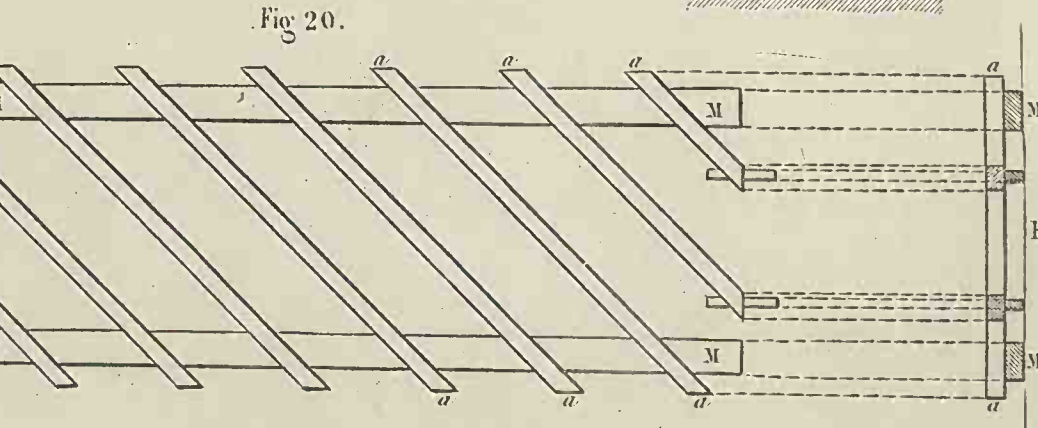

Fig. 20.

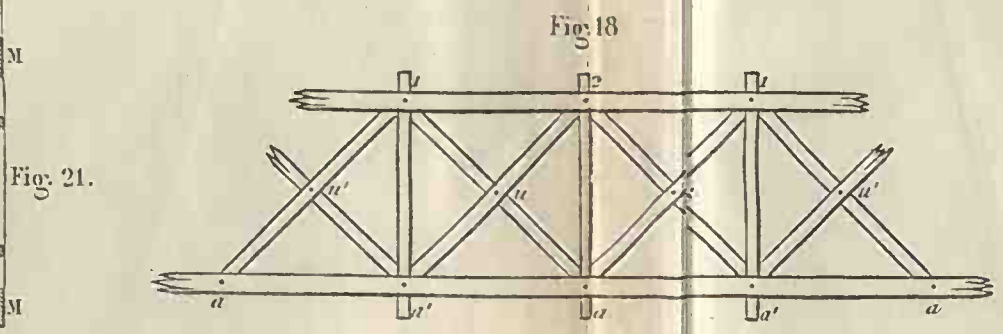

Fig. 18.

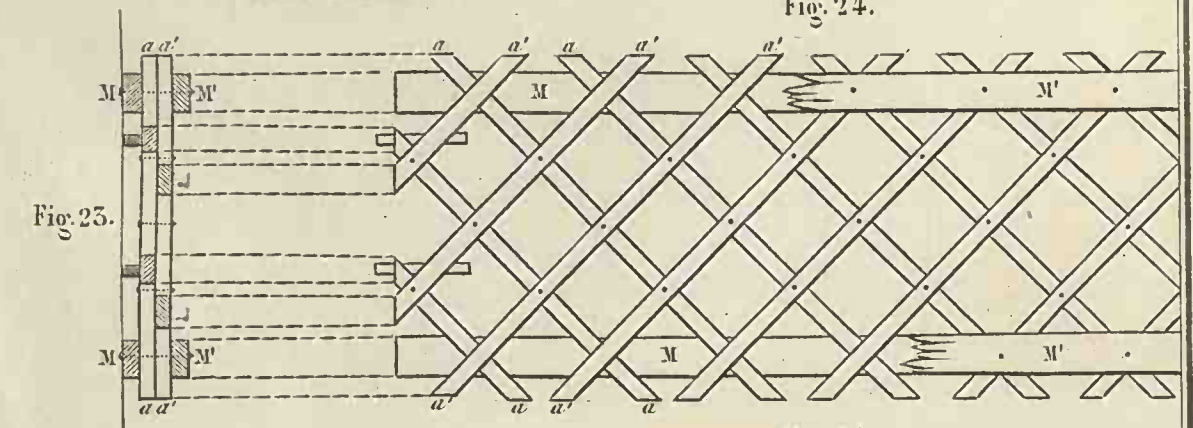

Fig. 25.

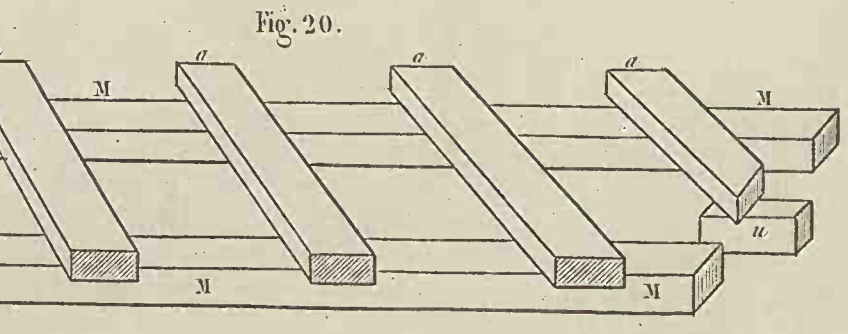

Fig. 20.

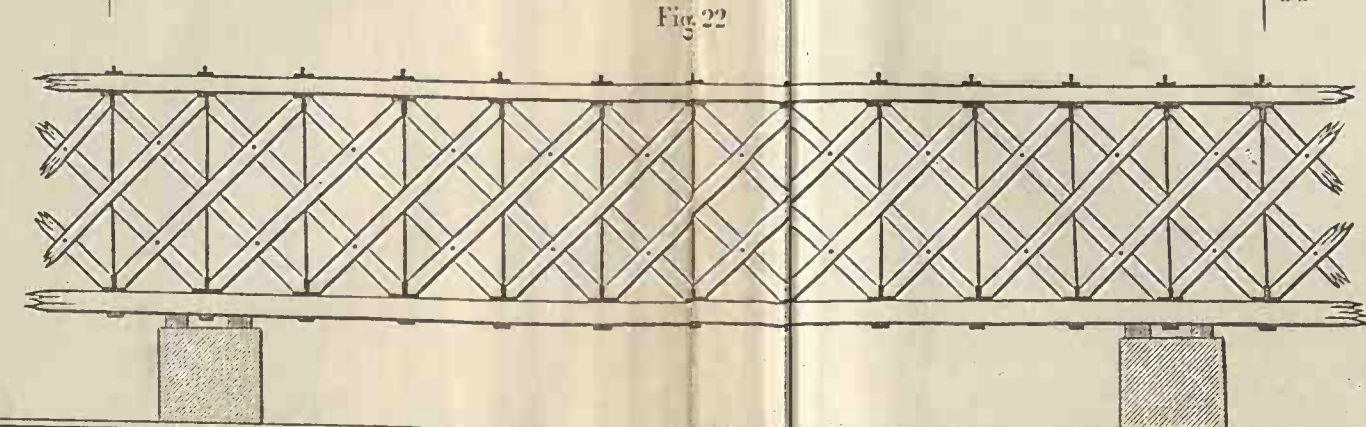

Fig. 22.

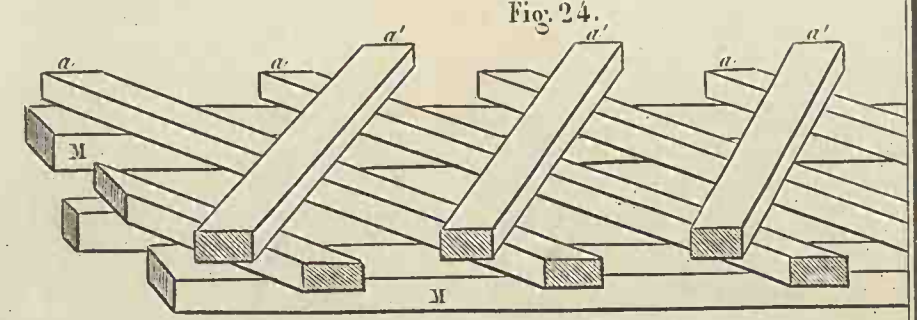

Fig. 24.

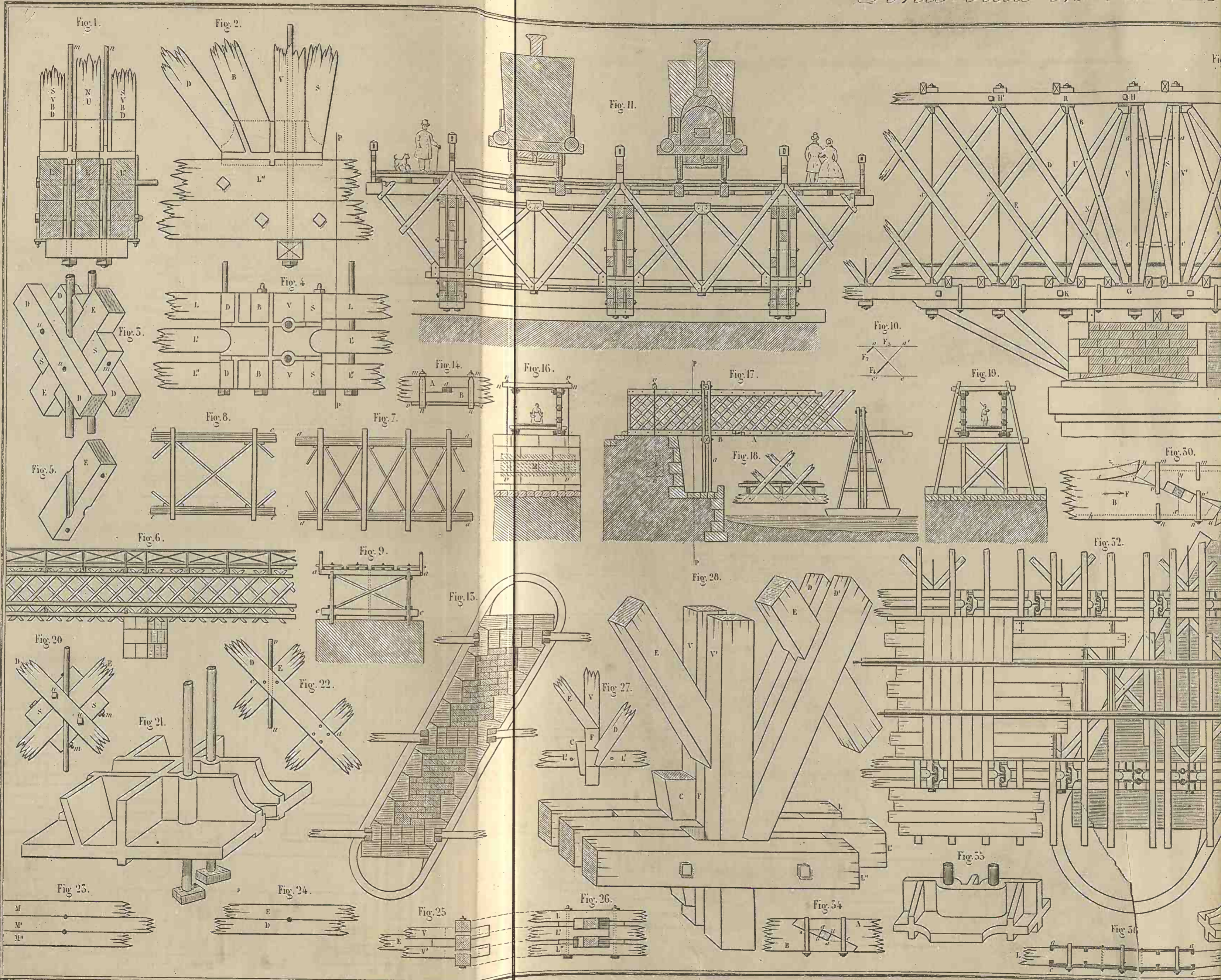

Fig. 29.

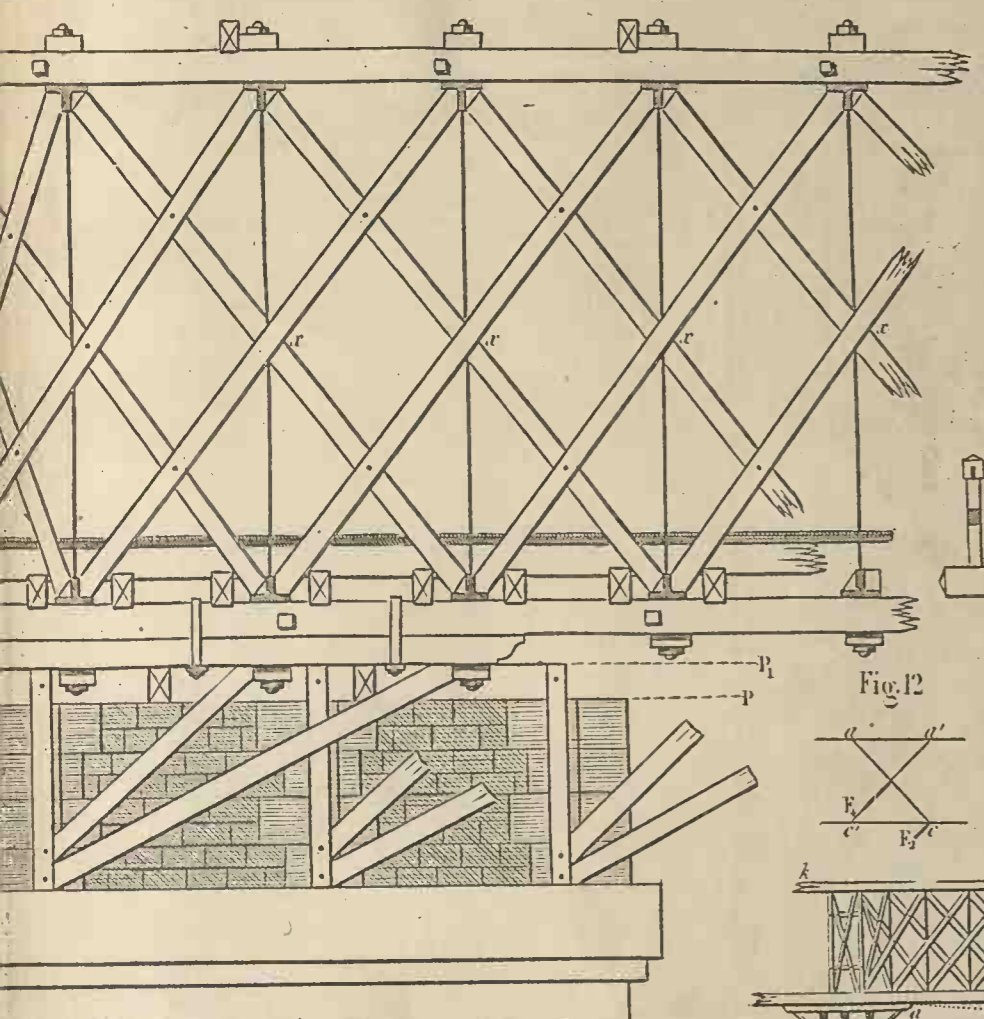

Fig. 12

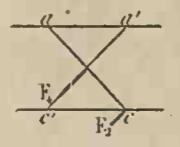

Fig. 39

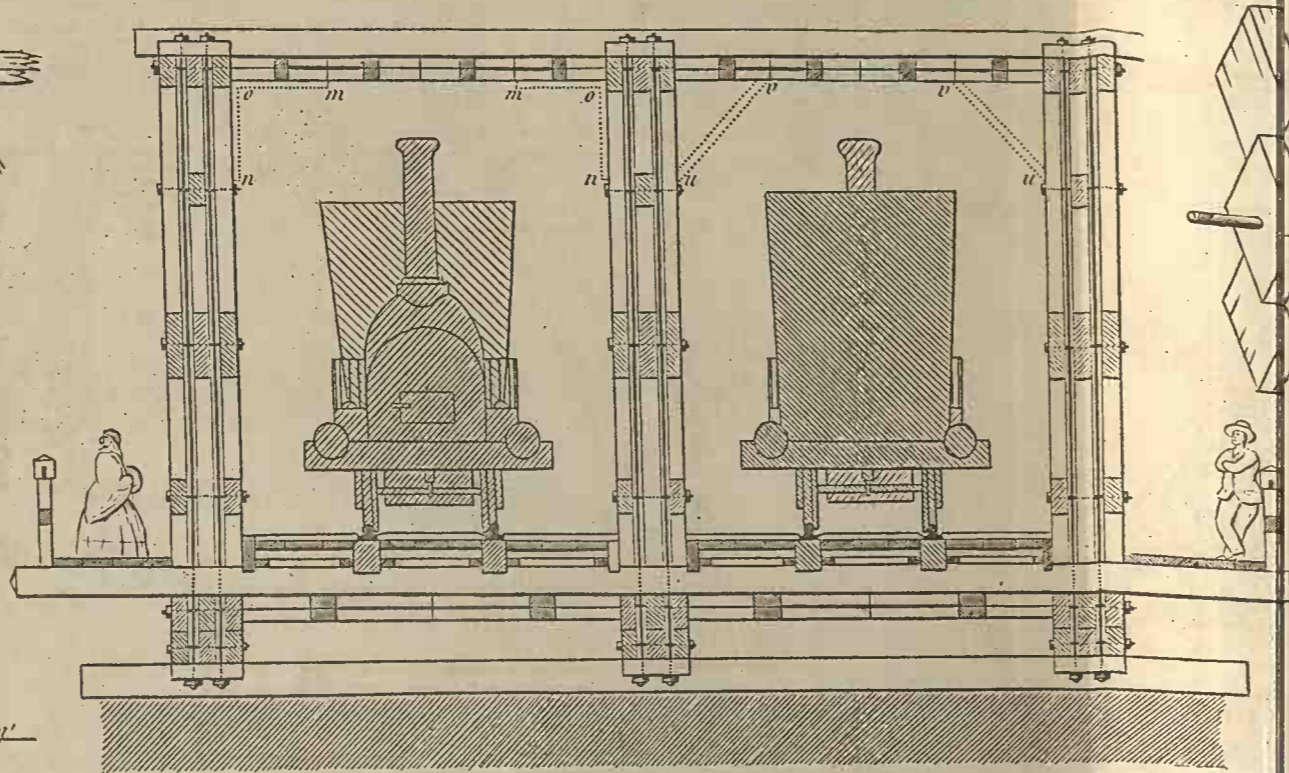

Fig. 40

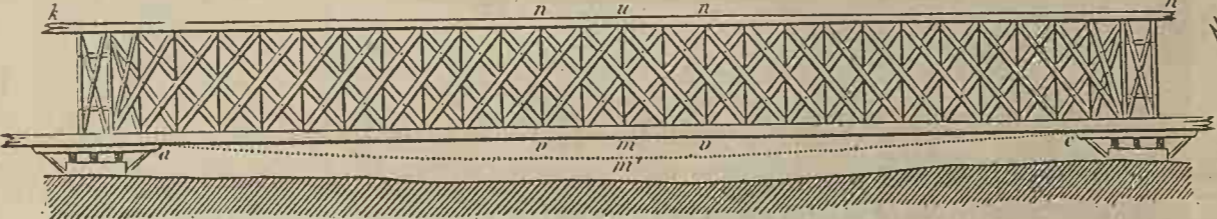

Fig. 15.



Fig. 45.

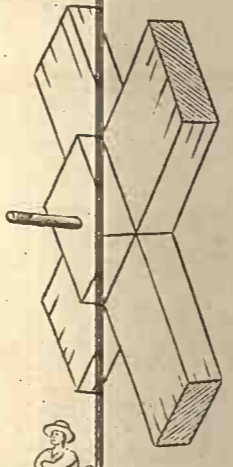

Fig. 44.

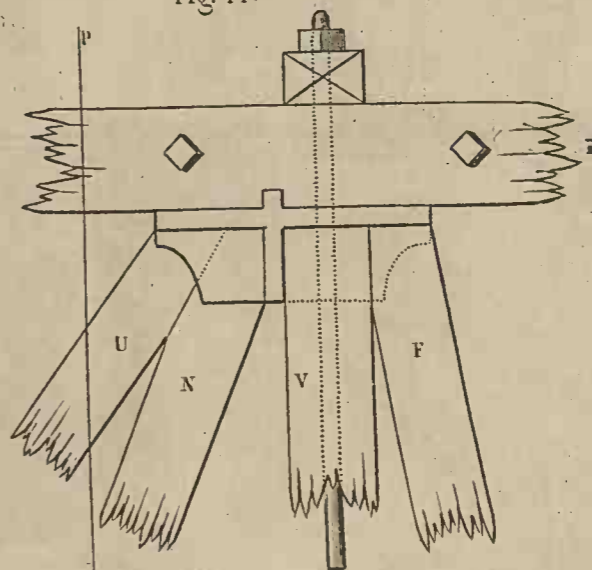

Fig. 45.

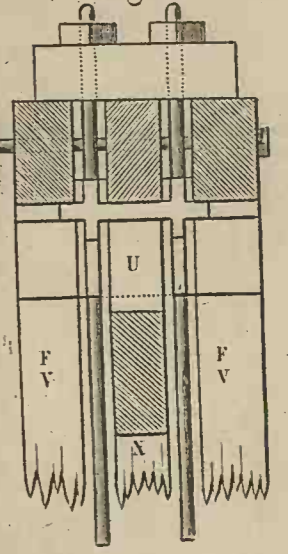

Fig. 46.

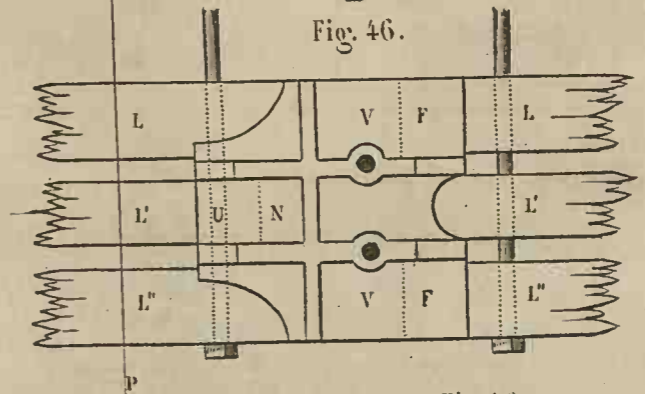

Fig. 47

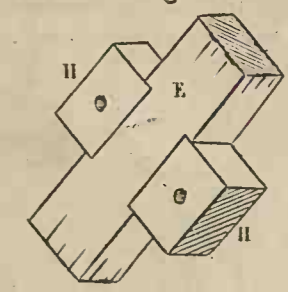

Fig. 51.

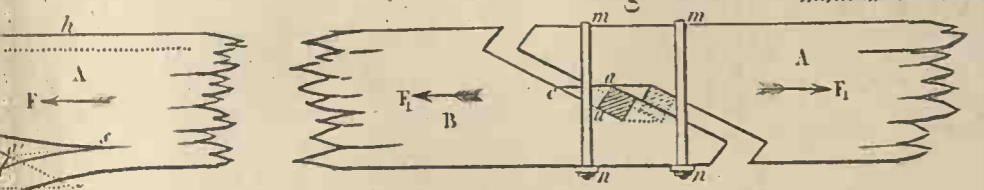

Fig. 42

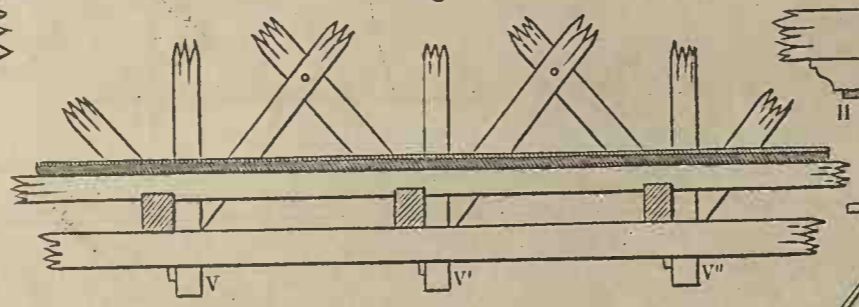

Fig. 41



Fig. 49.

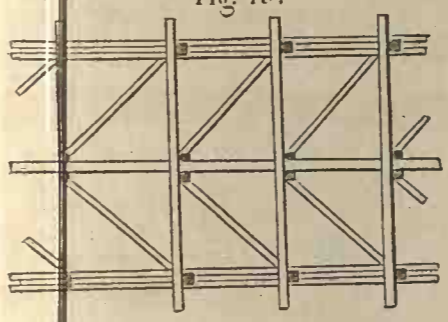

Fig. 50.

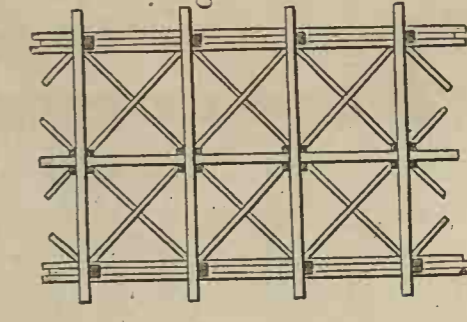

Fig. 48.

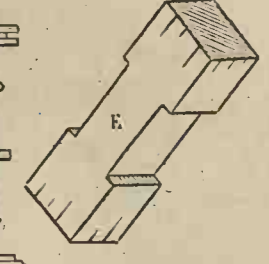

Fig. 55.

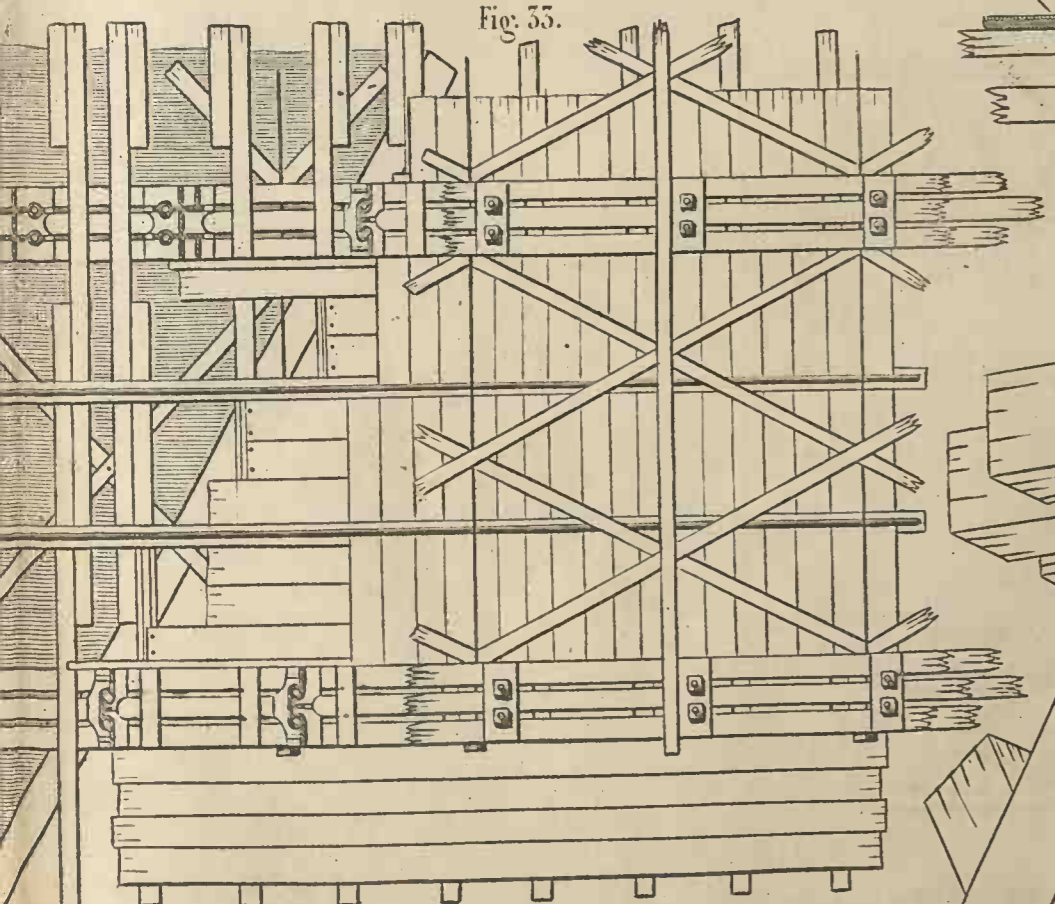

Fig. 55.

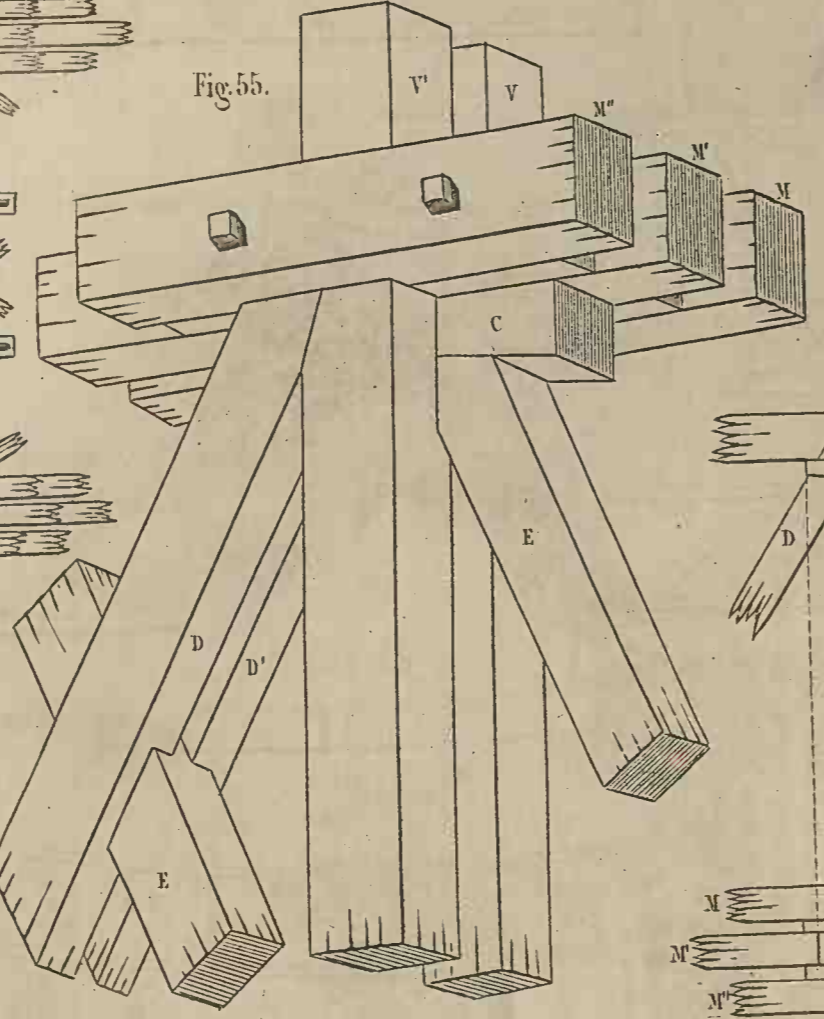

Fig. 52

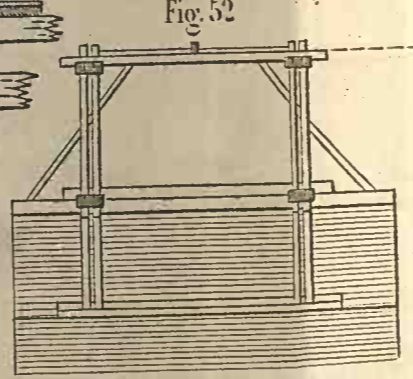

Fig. 55.

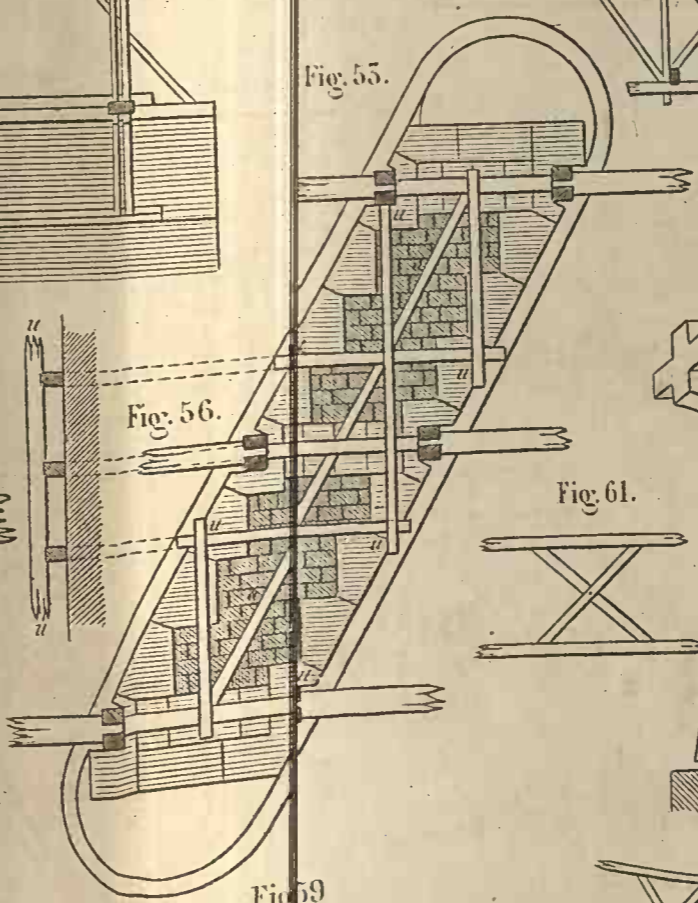

Fig. 54

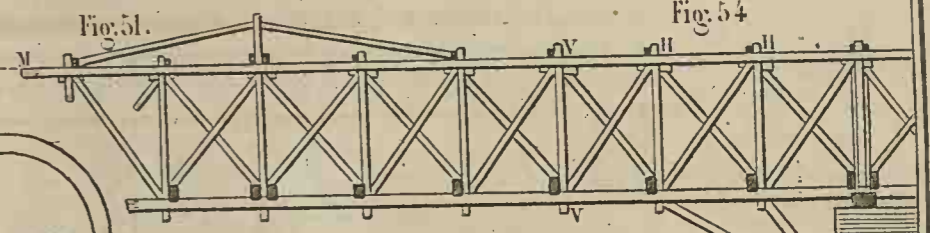

Fig. 60.

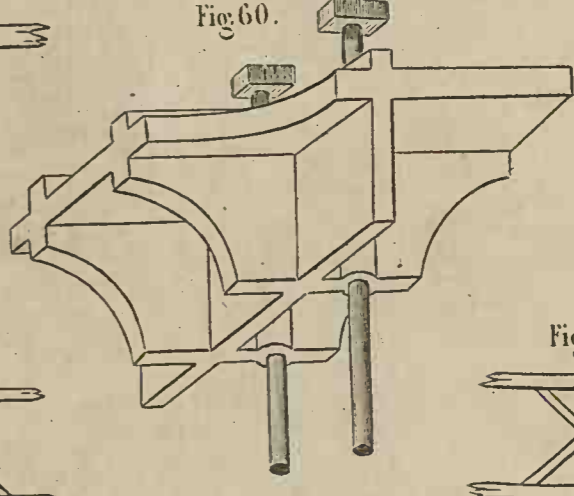

Fig. 62

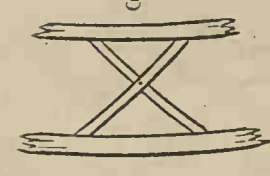

Fig. 61.

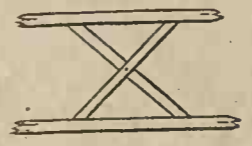

Fig. 65.

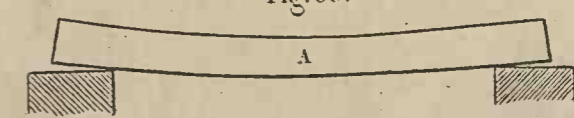

Fig. 64.

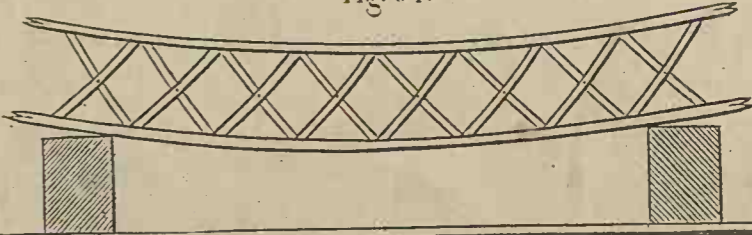

Fig. 57.

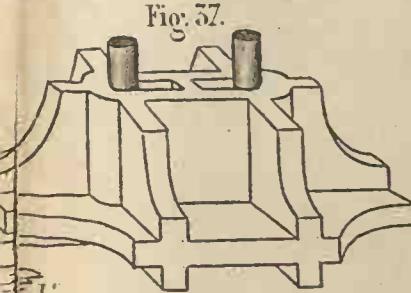

Fig. 58.

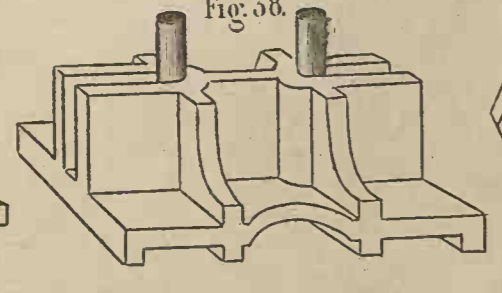

Fig. 57.

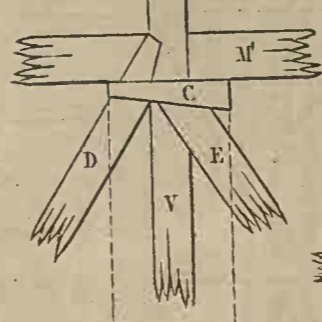
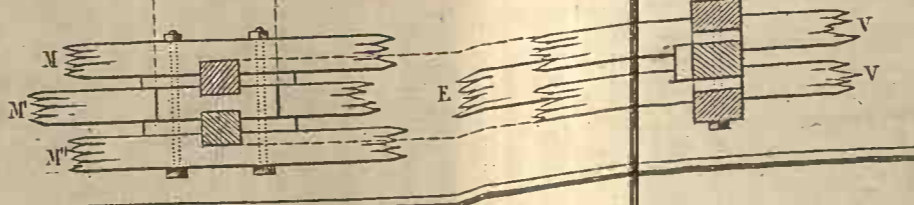

Fig. 58.



Charpentier. Pl. 66.

