



RPR

BIBLIOTECA CENTRALA
A
UNIVERSITAȚII
DIN
BUCUREȘTI

No. Curent Format

No. Inventar *24558* Anul

Secția Raftul

IV. 18653
~~Jno. A. 66. 640~~

COURS

DE

MATHÉMATIQUES

A L'USAGE

DES ARCHITECTES, INGÉNIEURS CIVILS, ETC.

113452/113
328/12

PAR J. ADHÉMAR



APPLICATIONS DE GÉOMÉTRIE DESCRIPTIVE

[T. 113. 2]

COUPE DES PIERRES

Sixième Édition

PARIS

ARMAND COLIN, ÉDITEUR.

16, RUE DE CONDÉ, 16

J. BAUDRY

15, RUE DES SAINTS-PÈRES

BERLIN

MAX WINCKELMANN, SPITTELMARKET, 2.

BERTHOUD FRÈRES

QUAI DES AUGUSTINS, 45

MADRID

A. DURAN, CARRERA DE SAN GERÓNIMO, 2.

1870

24558

9/953

1961

L

18651
24558

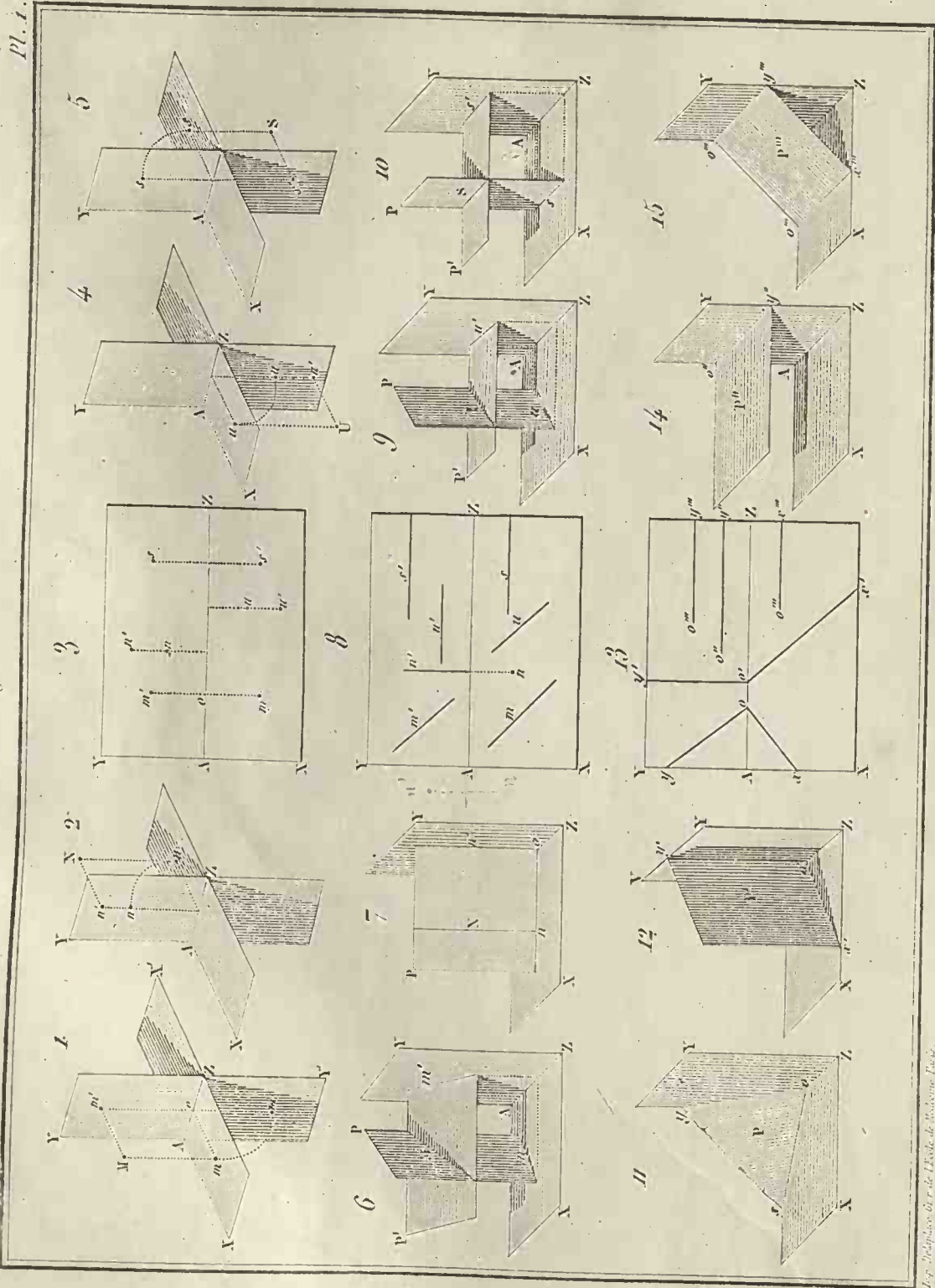
1956

12c 115/06

B.C.U. Bucuresti
C24558

Projections

Introduction



Pl. I.

Mathematical

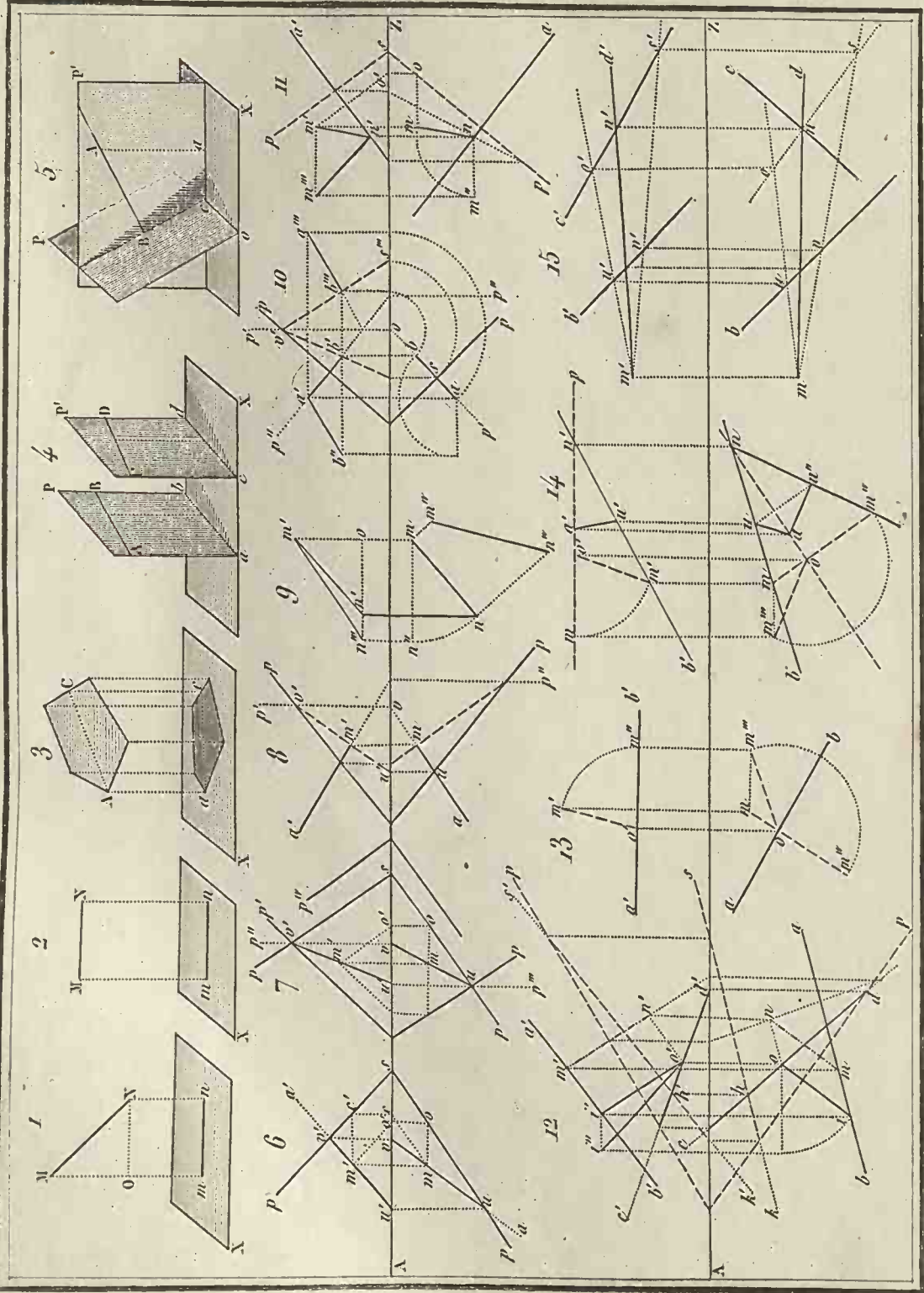
Fig. 1. 2. 3. 4. 5. 6. 7. 8. 9. 10. 11. 12. 13. 14. 15.



Points, lignes droites, plans

Introduction

Pl. 2.

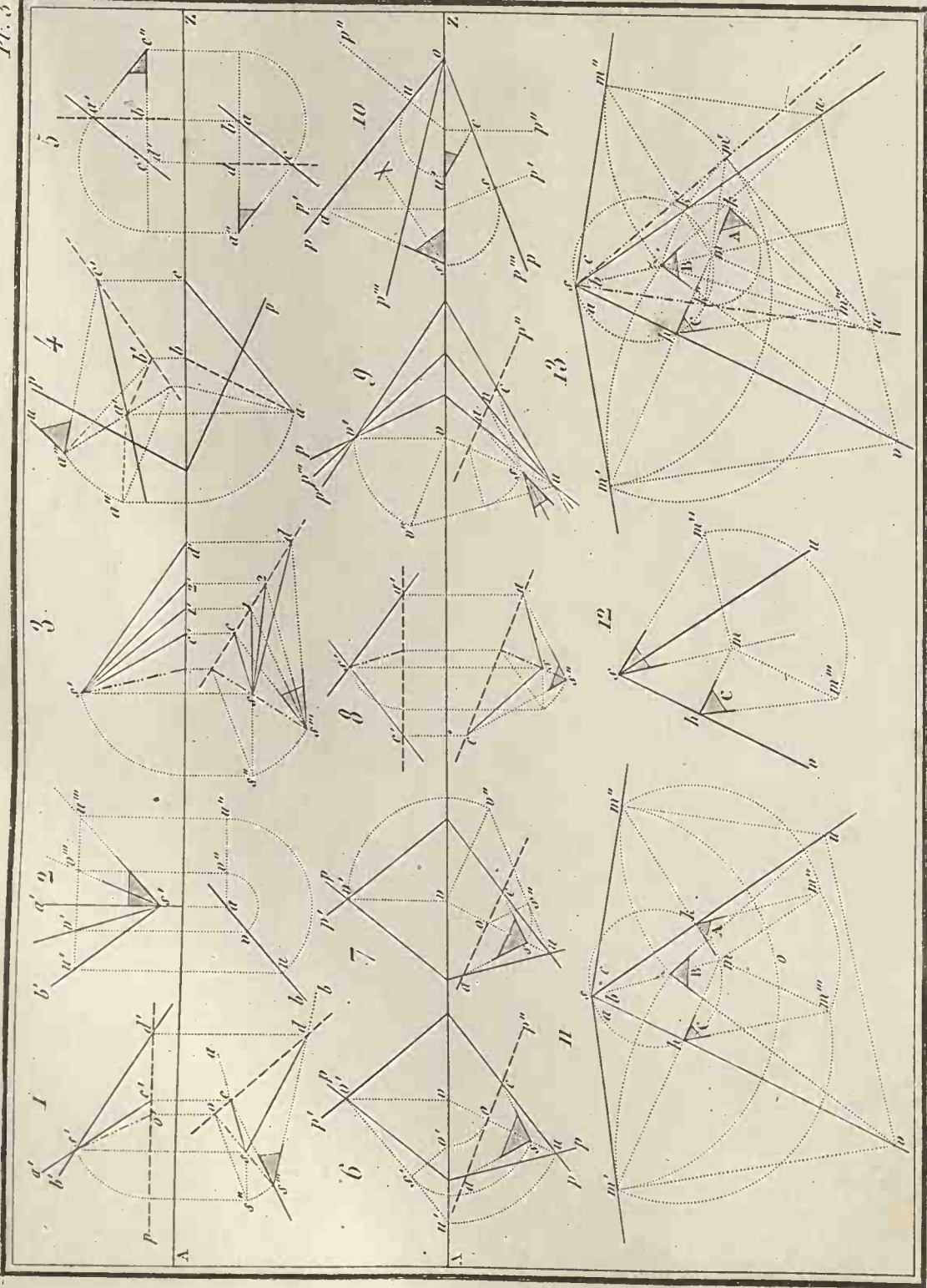


-Hillemar del.

Angles des droites et des plans

Introduction

Pl. 3

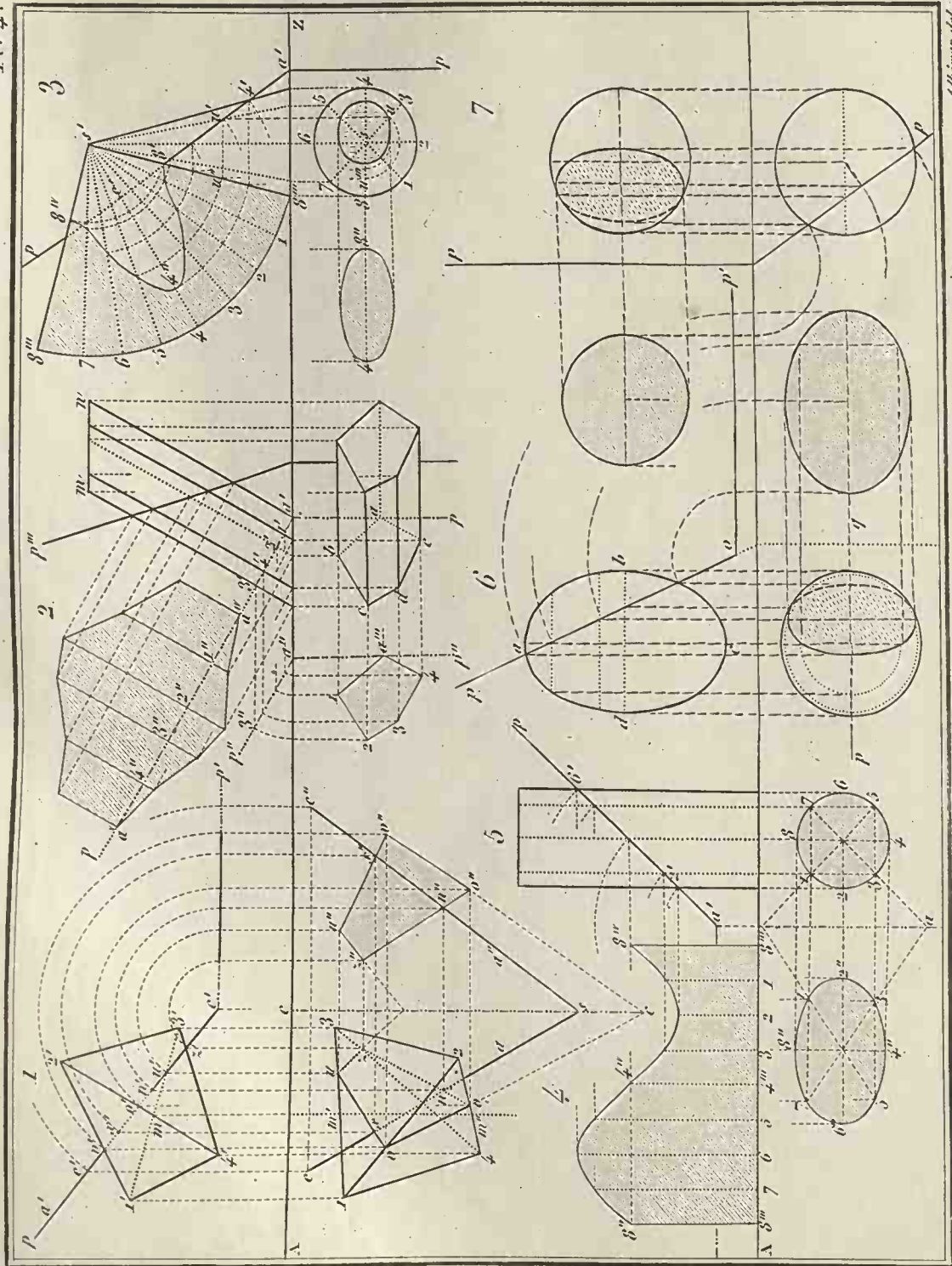


Alfonso del.

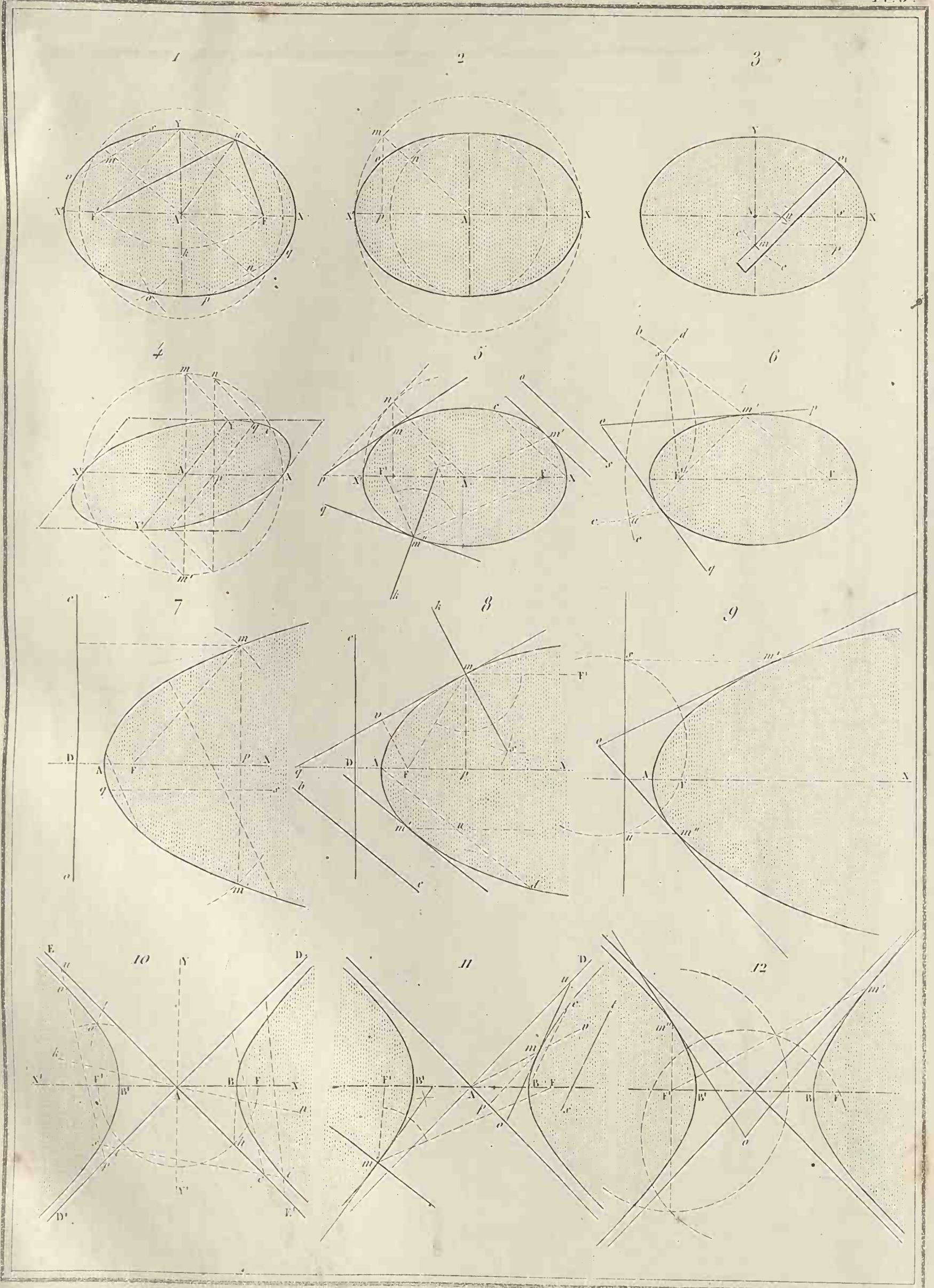
Sections et courbes planes.

pl. 4.

Introduction



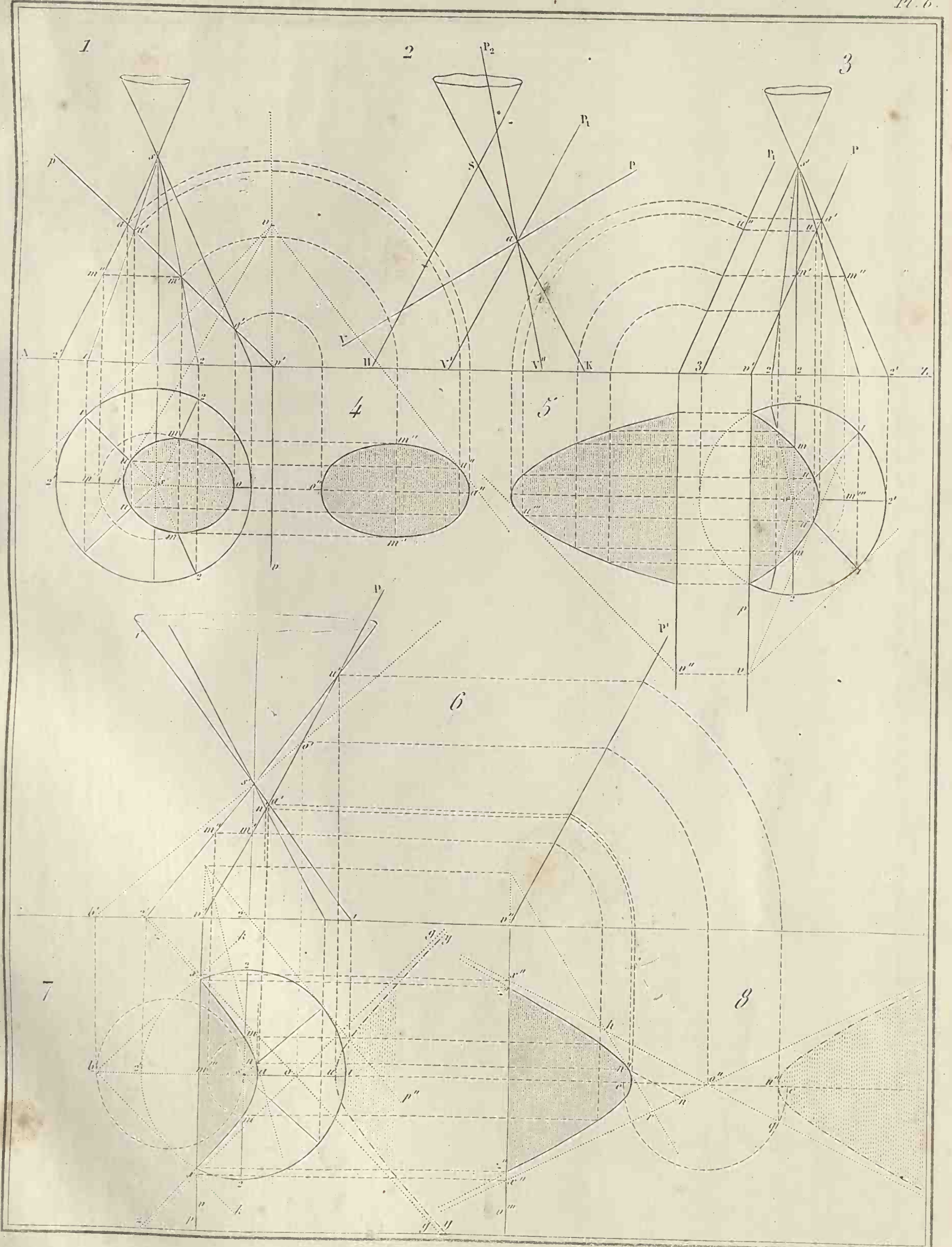
Delicieux del.



Sections coniques

Introduction

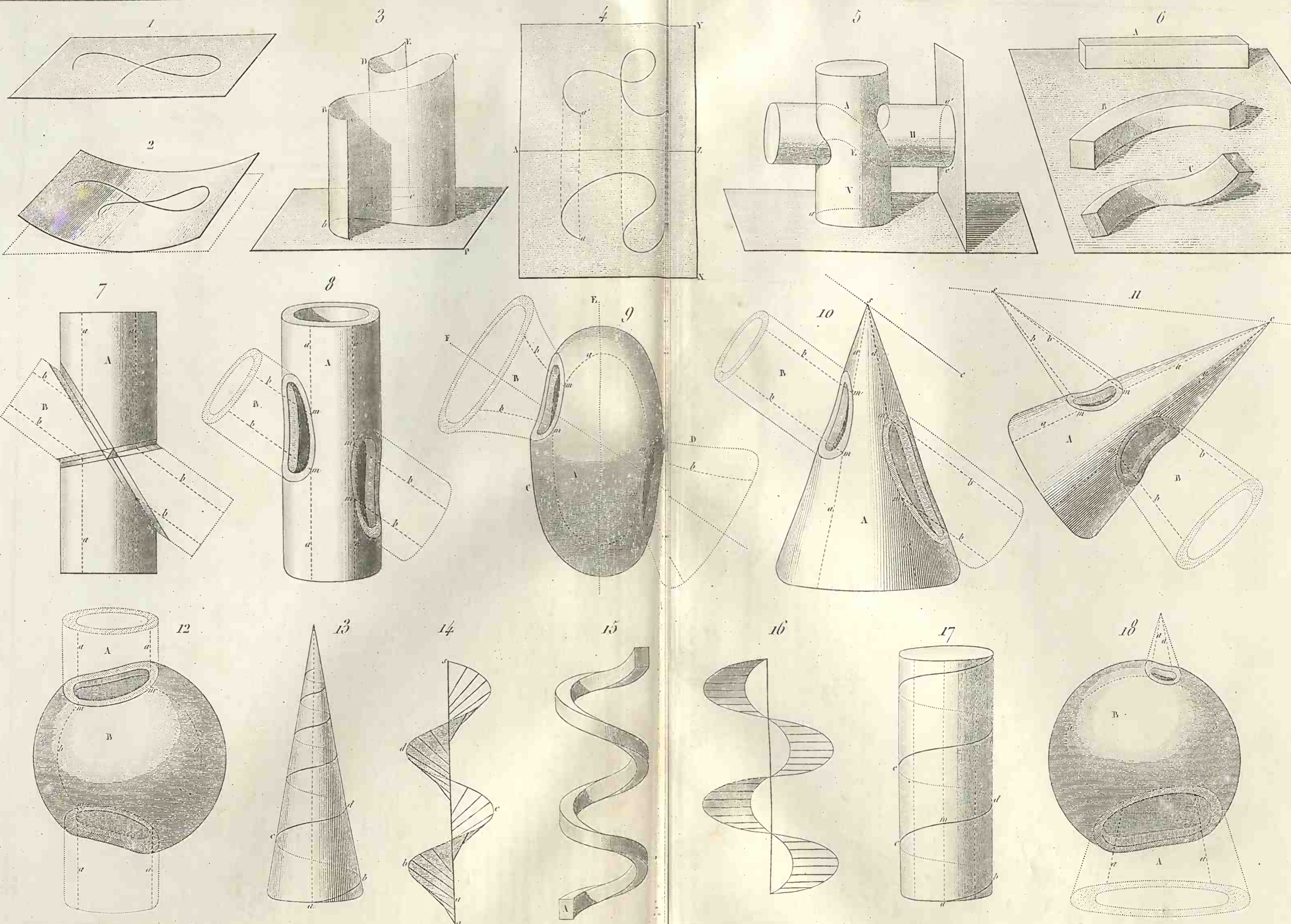
Pl. 6.

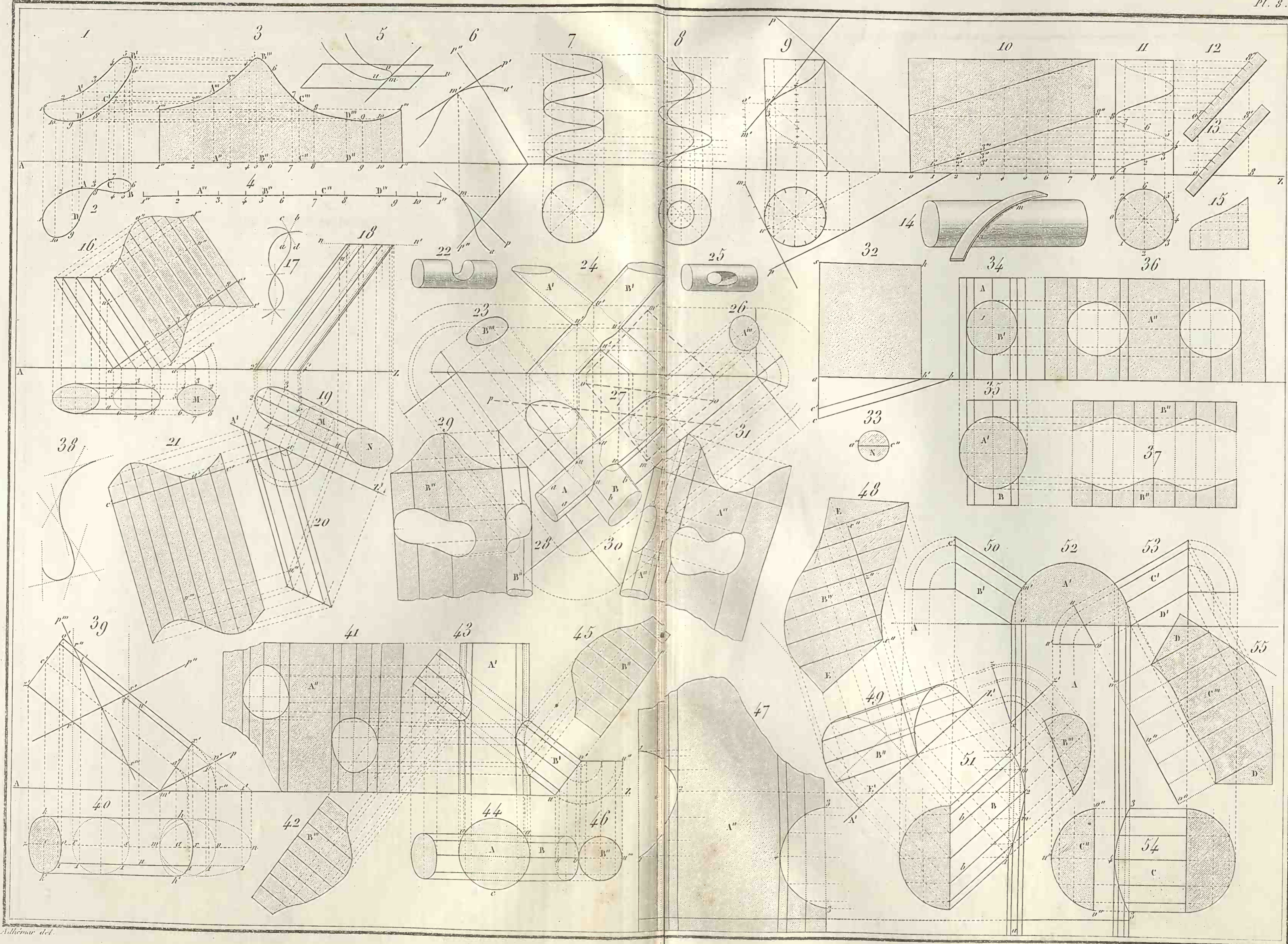


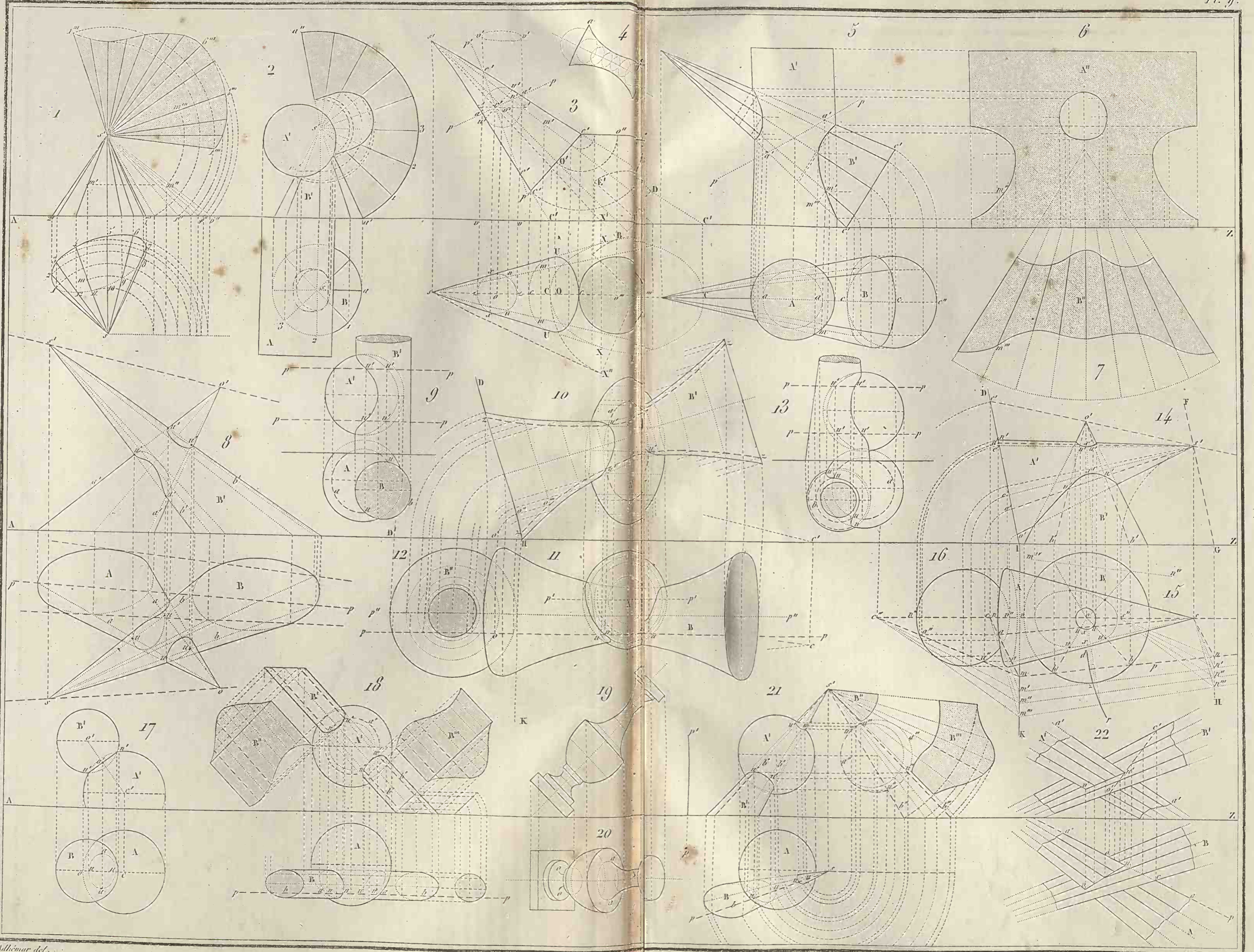
Courbes à double courbure.

Introduction

Pl. 7.







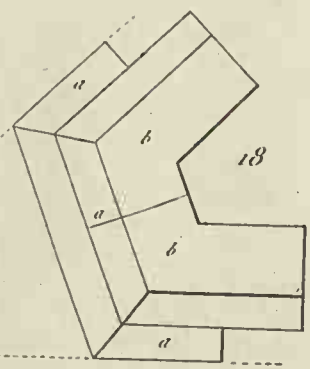
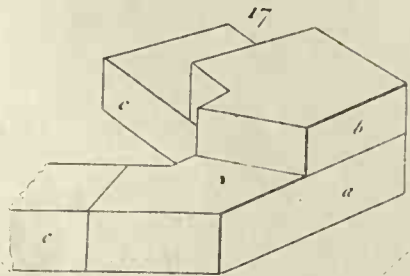
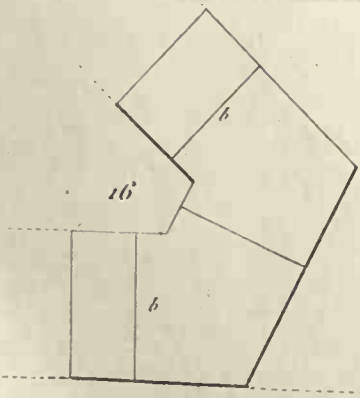
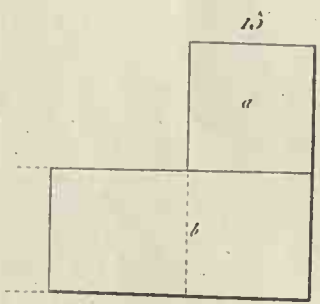
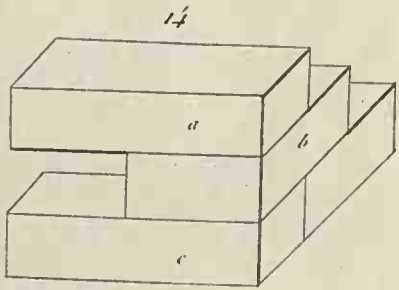
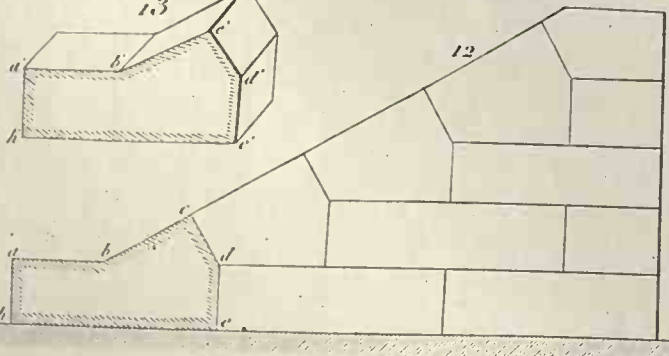
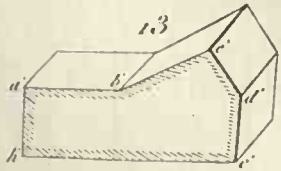
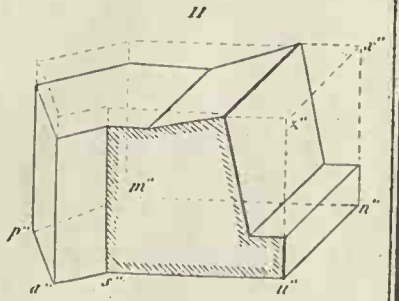
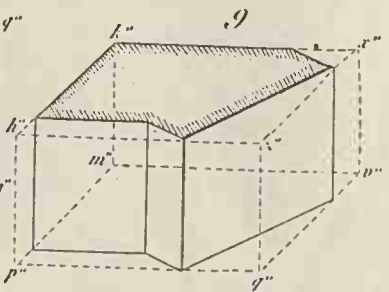
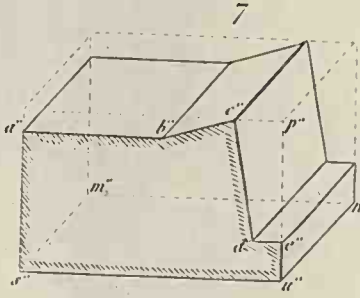
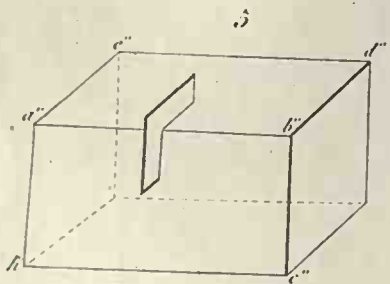
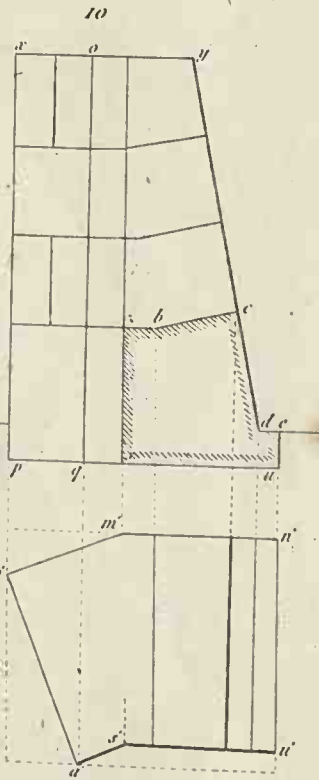
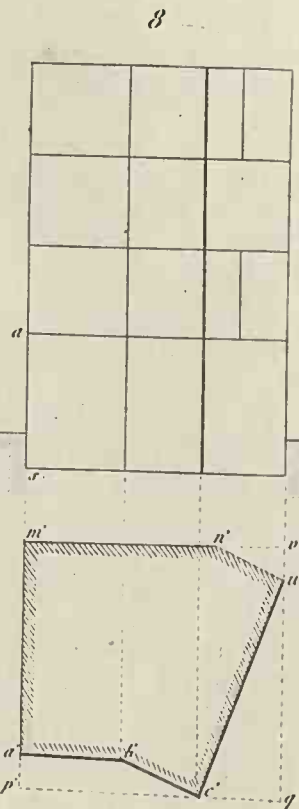
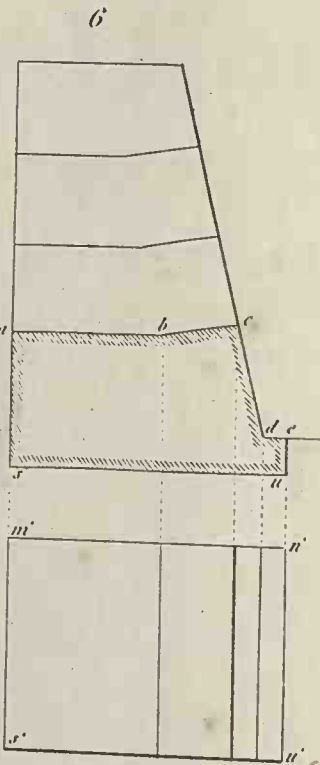
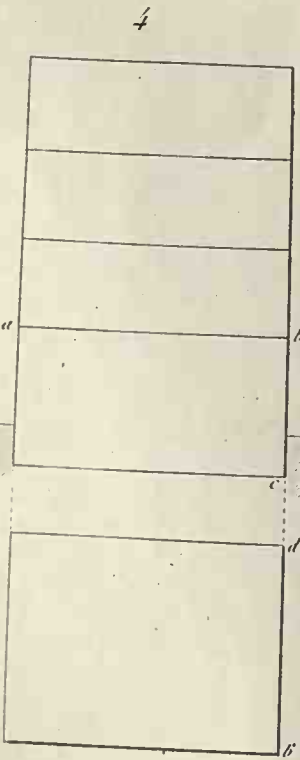
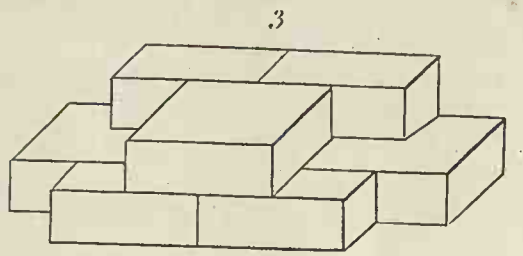
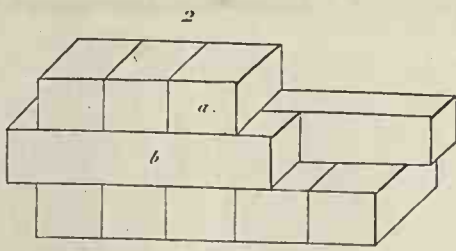
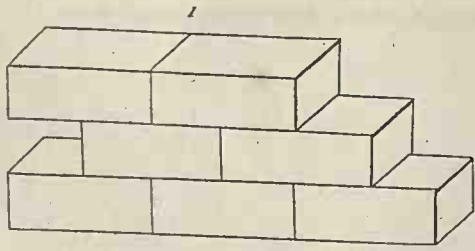
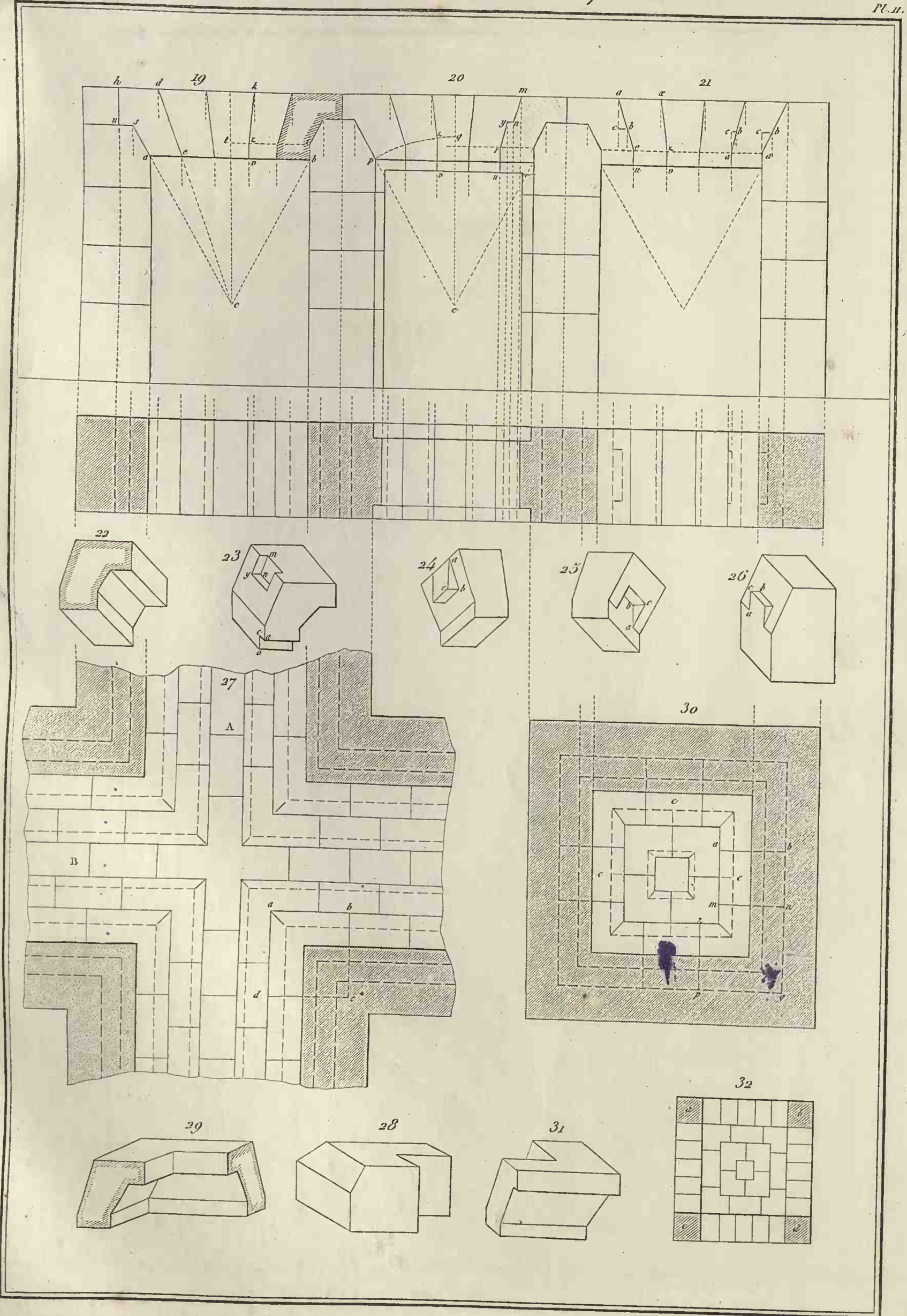


Plate-Bandes; Voutes plates.

Coupe des Pierres.

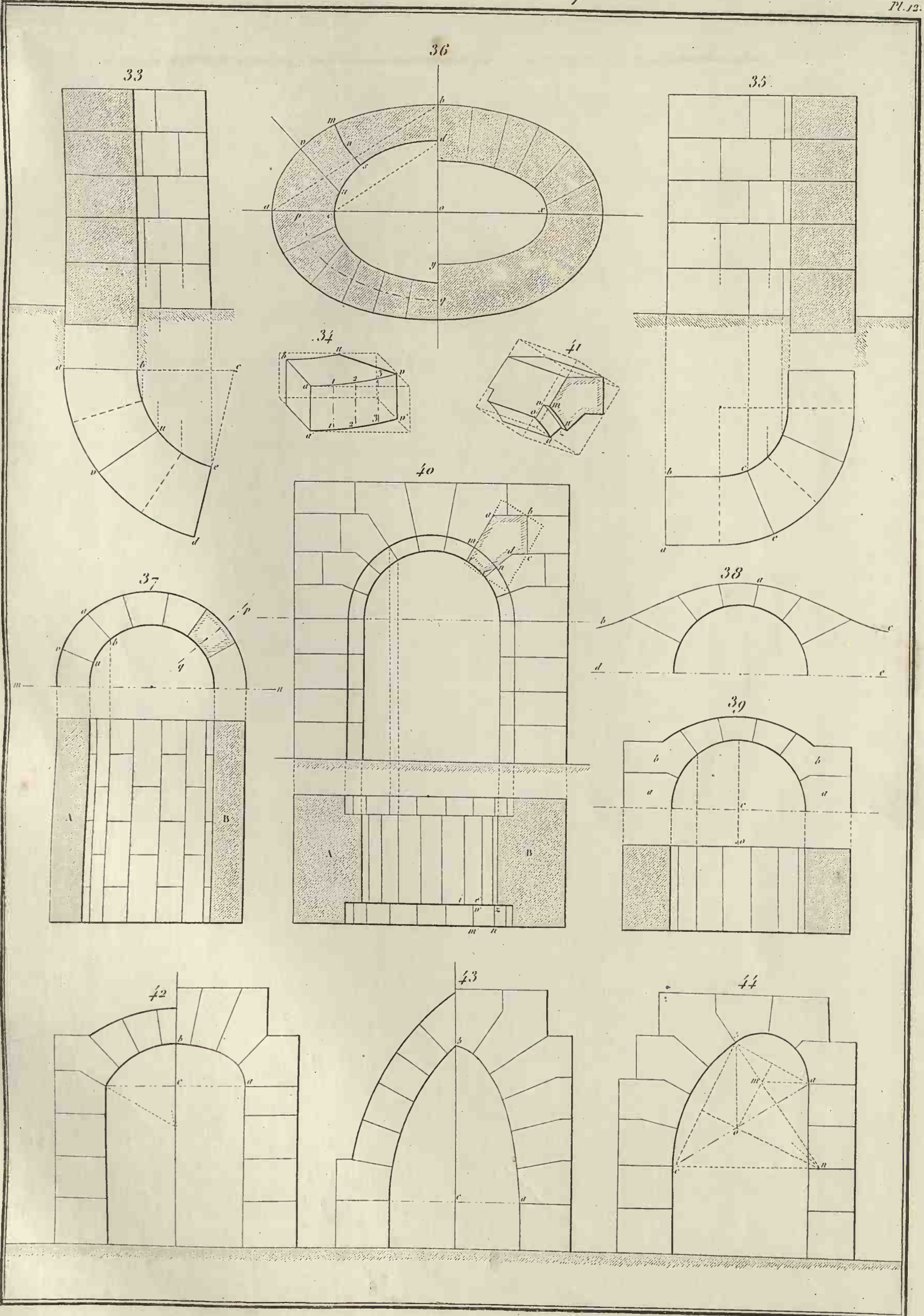
Pl. II.

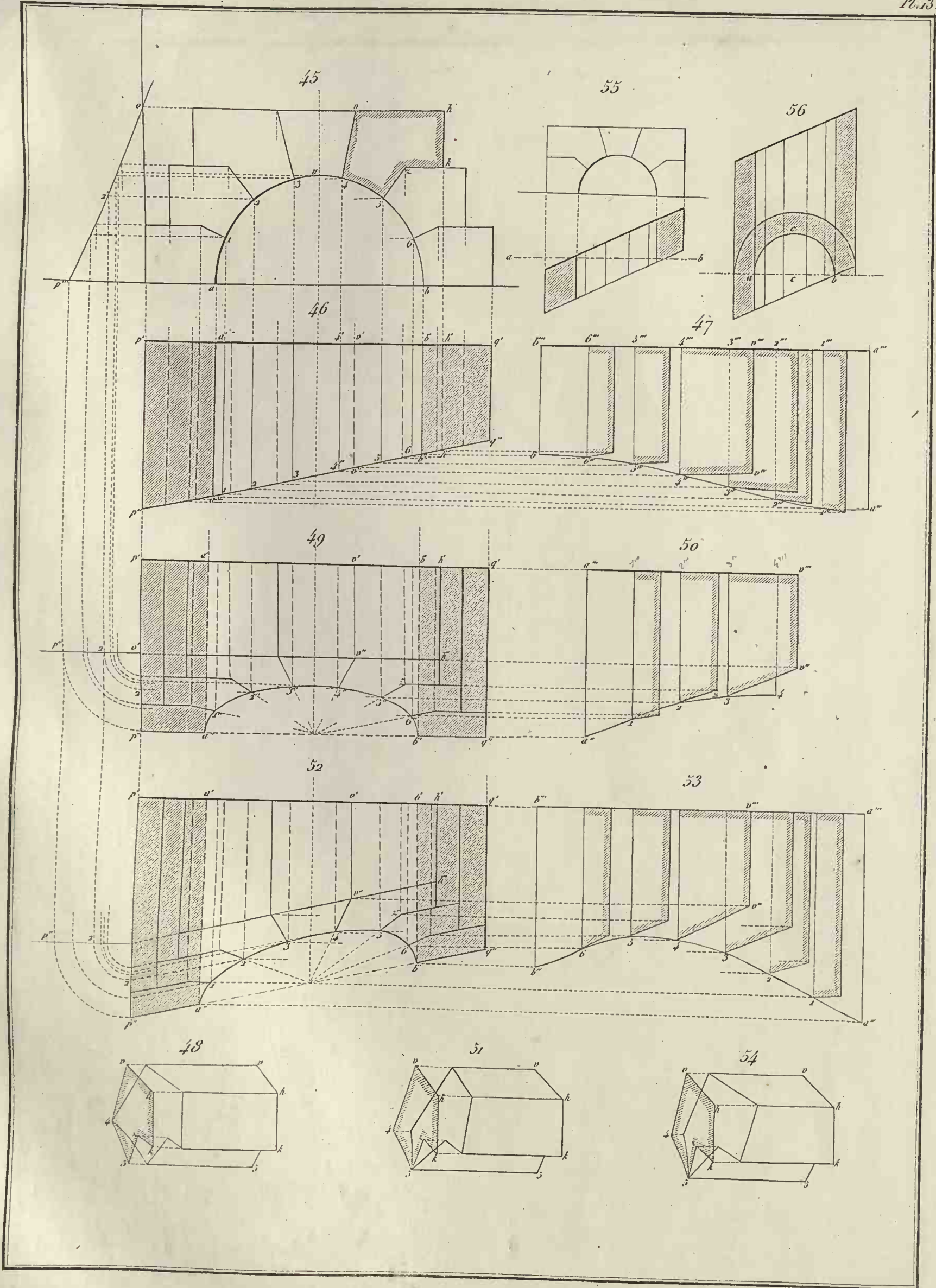


Murs ronds; Berceaux et portes droites.

Coupe des Pierres

Pl. 12.

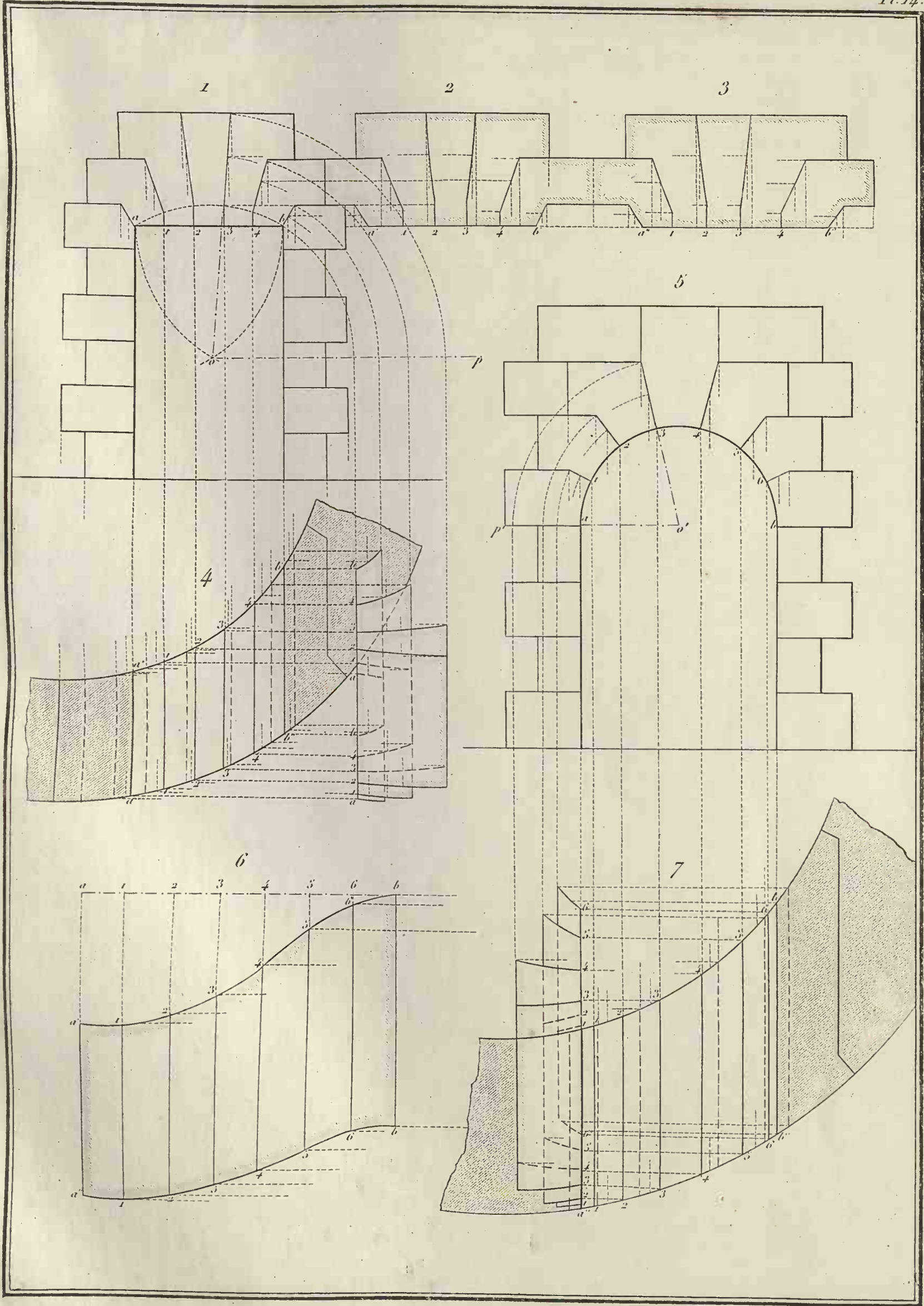




Portes dans une tour ronde.

Coupe des pierres

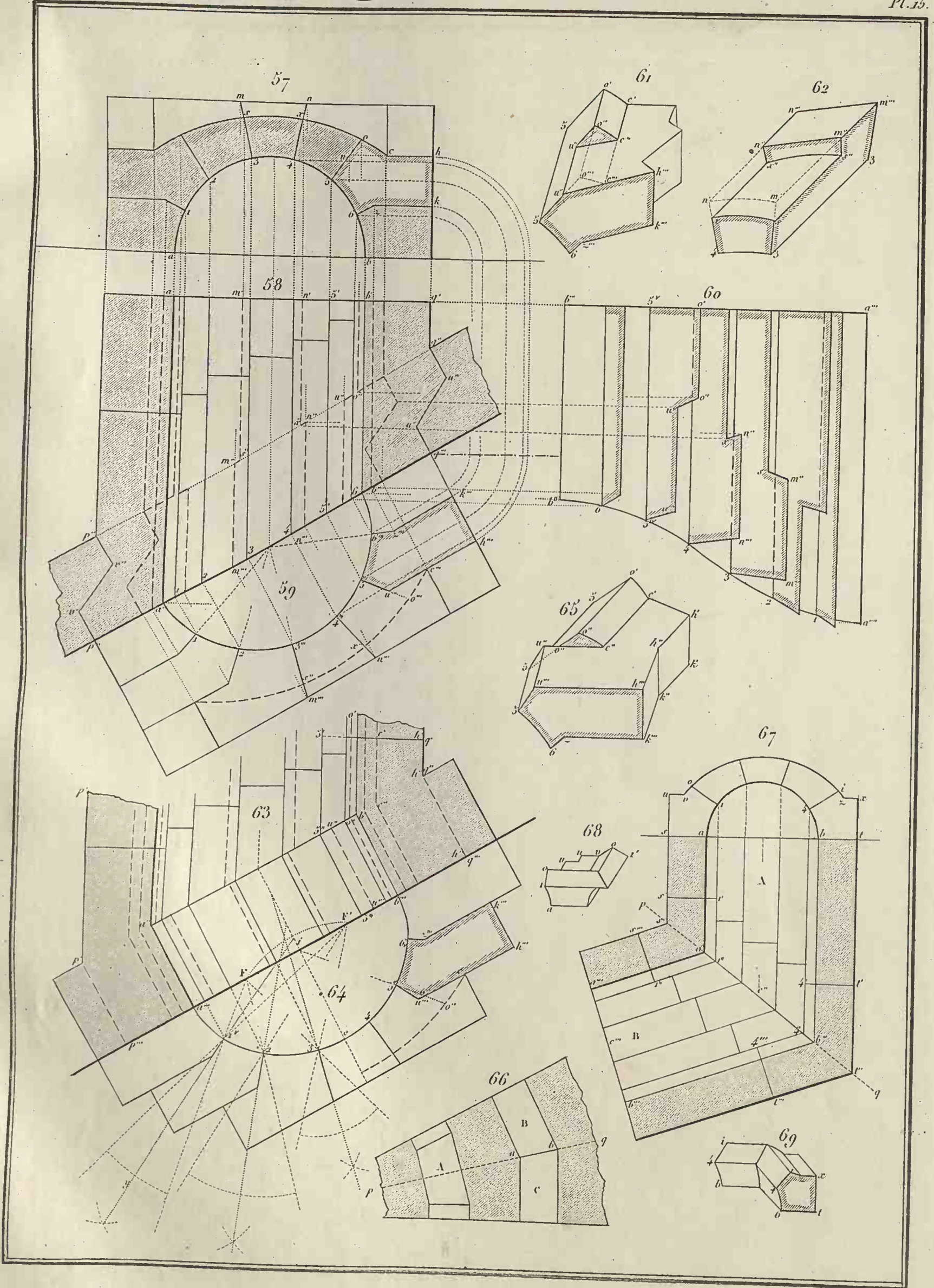
Pl. 14.

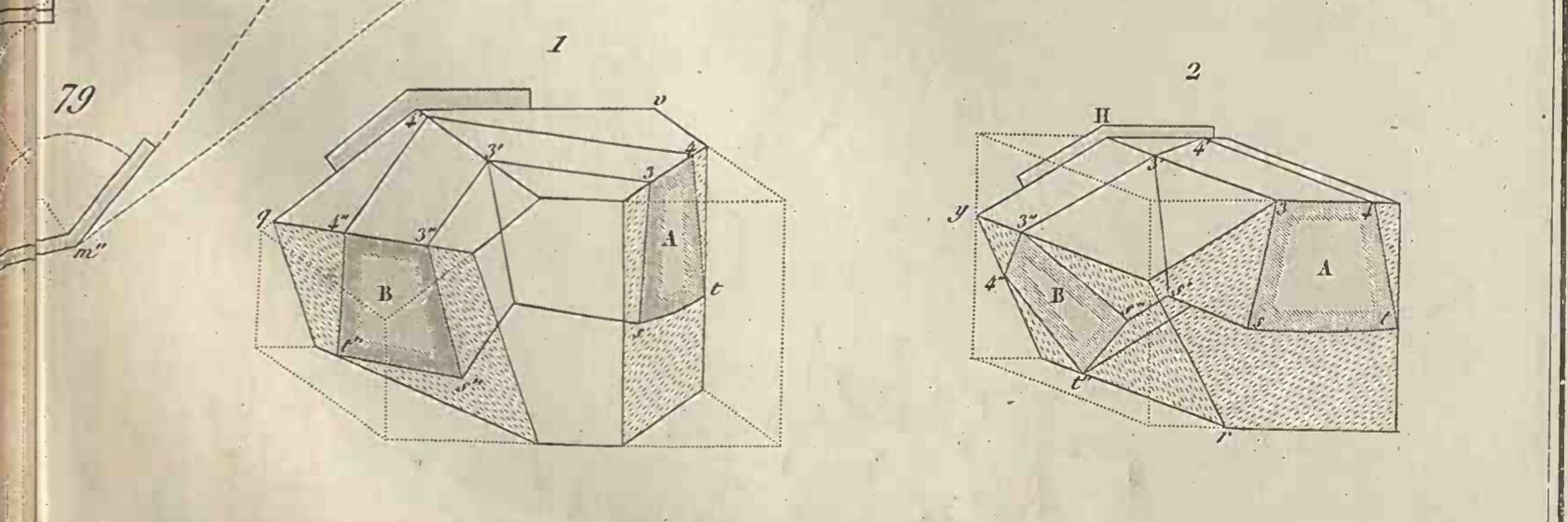
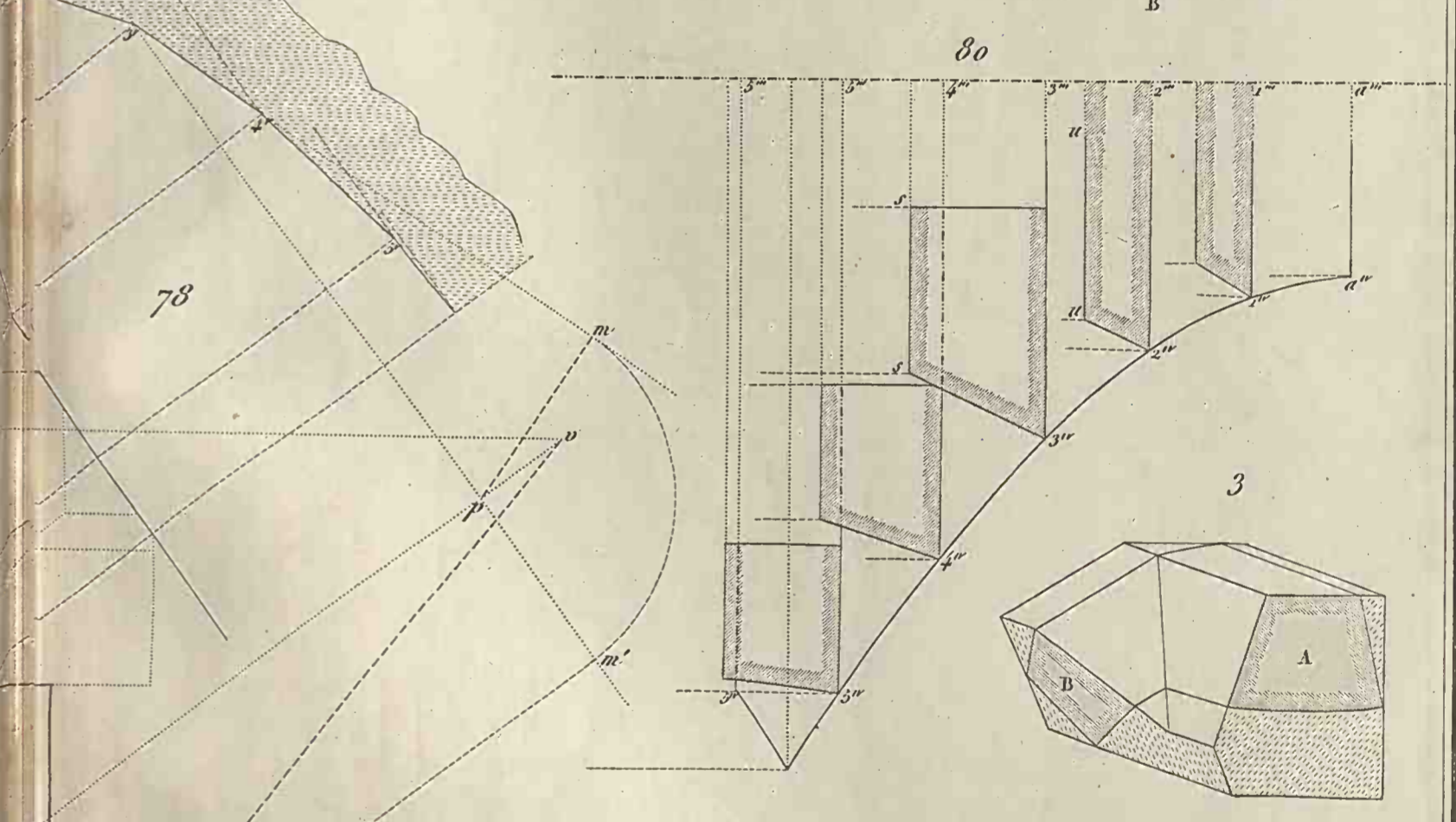
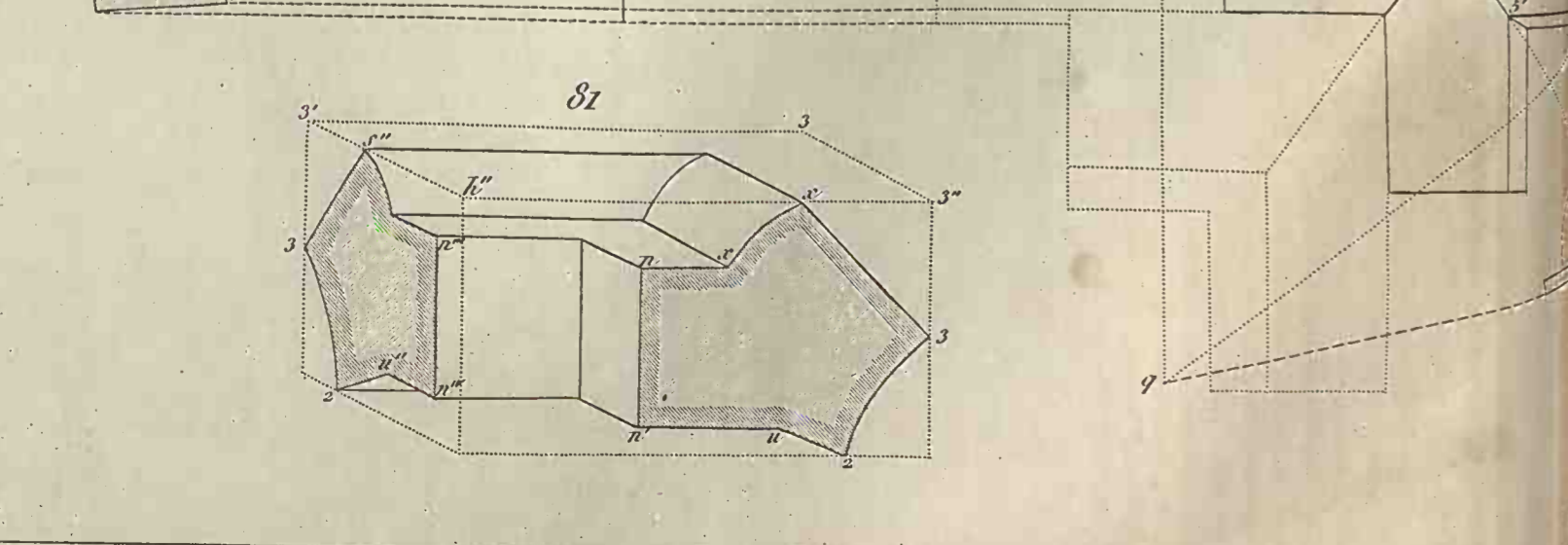
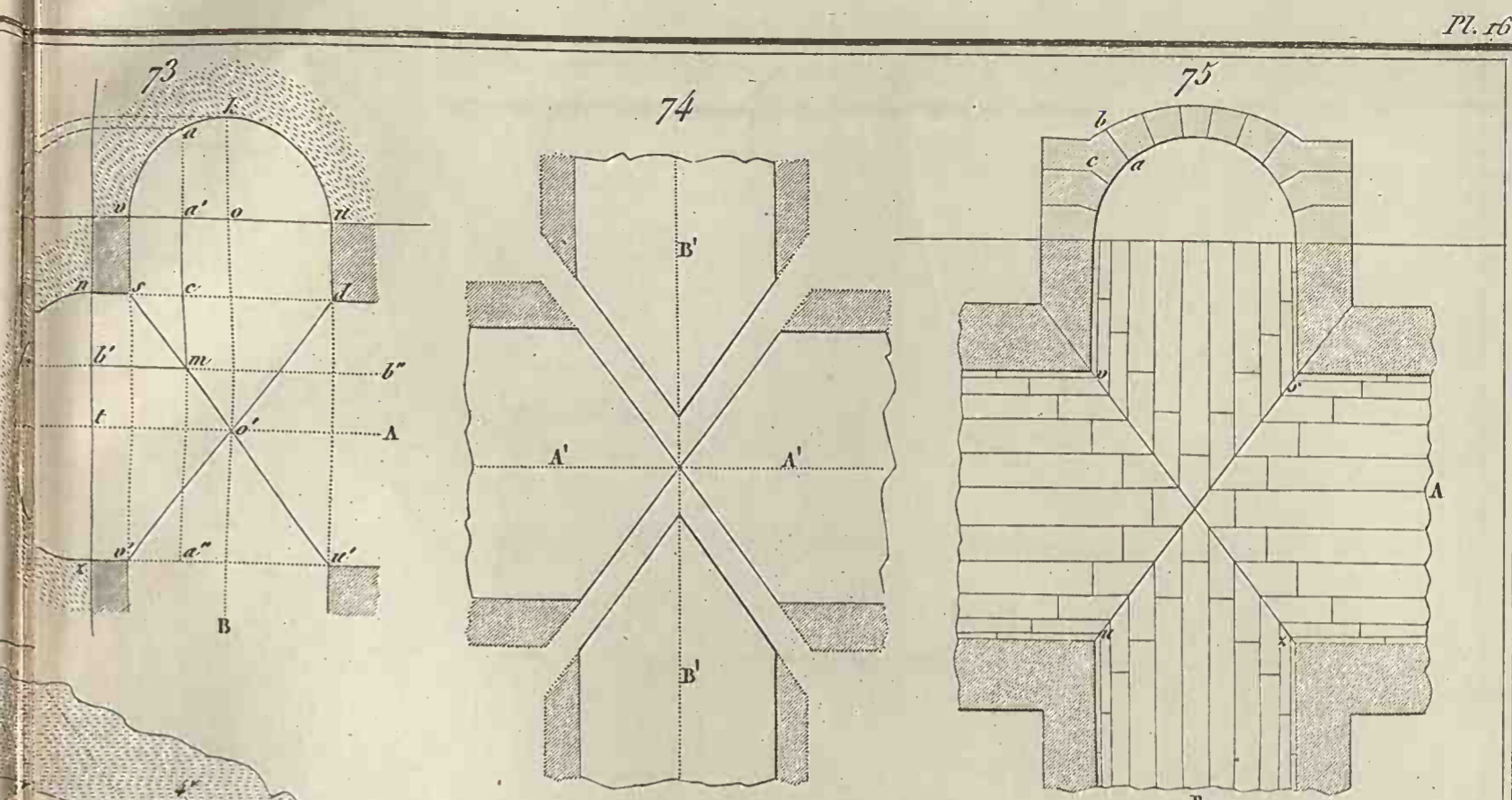
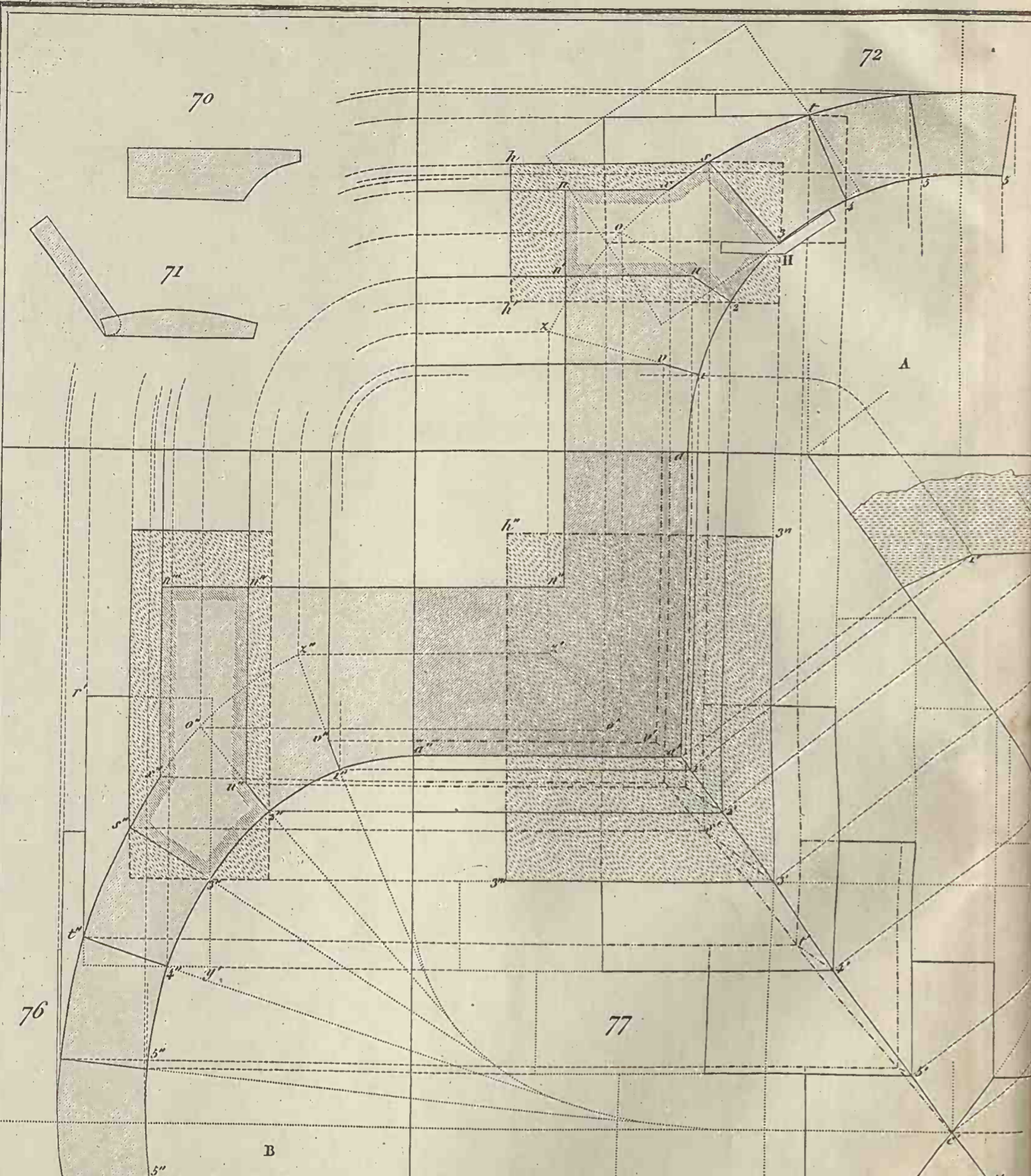


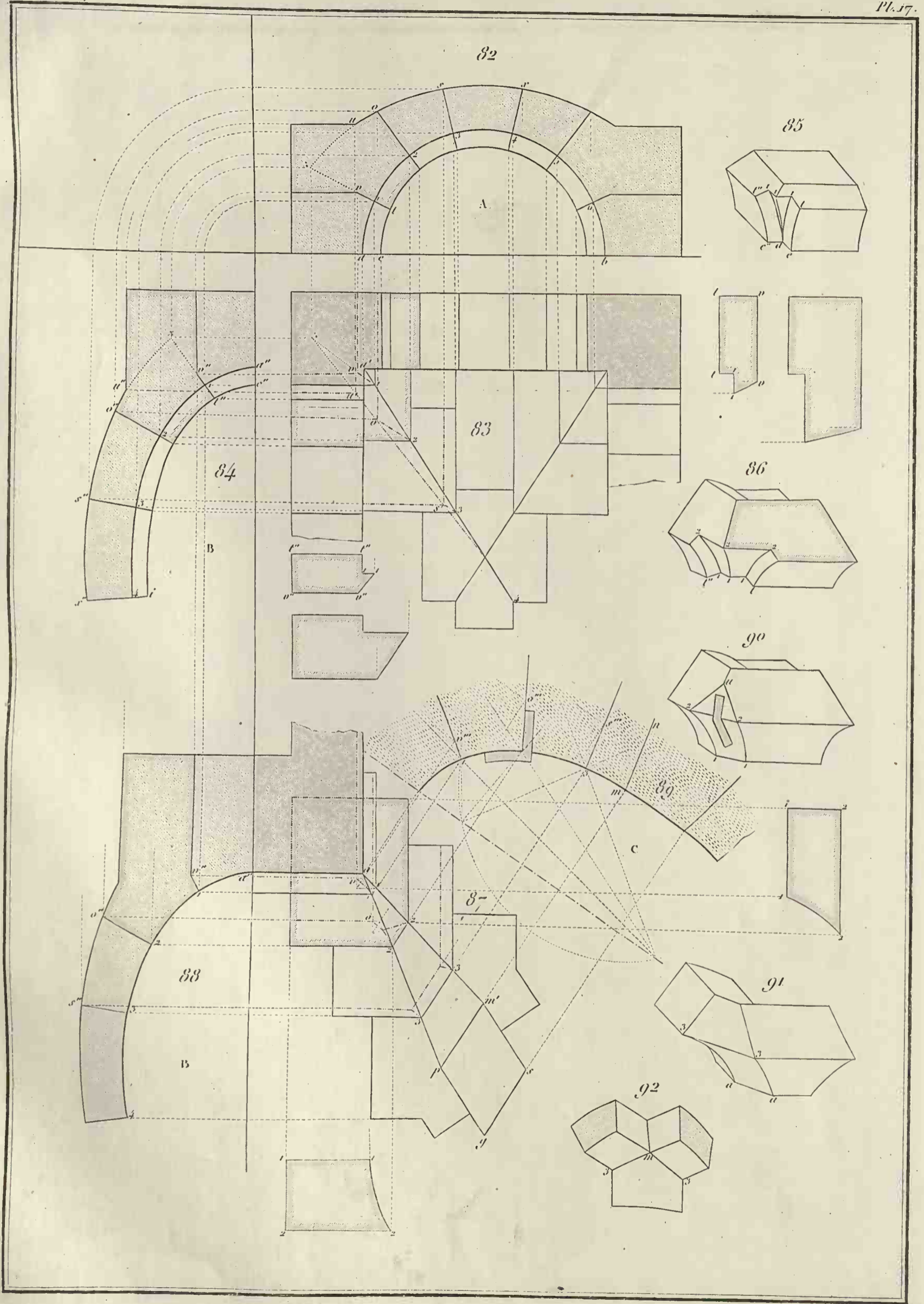
Berceaux liais.

Coupe des Pierres.

Pl. 15.



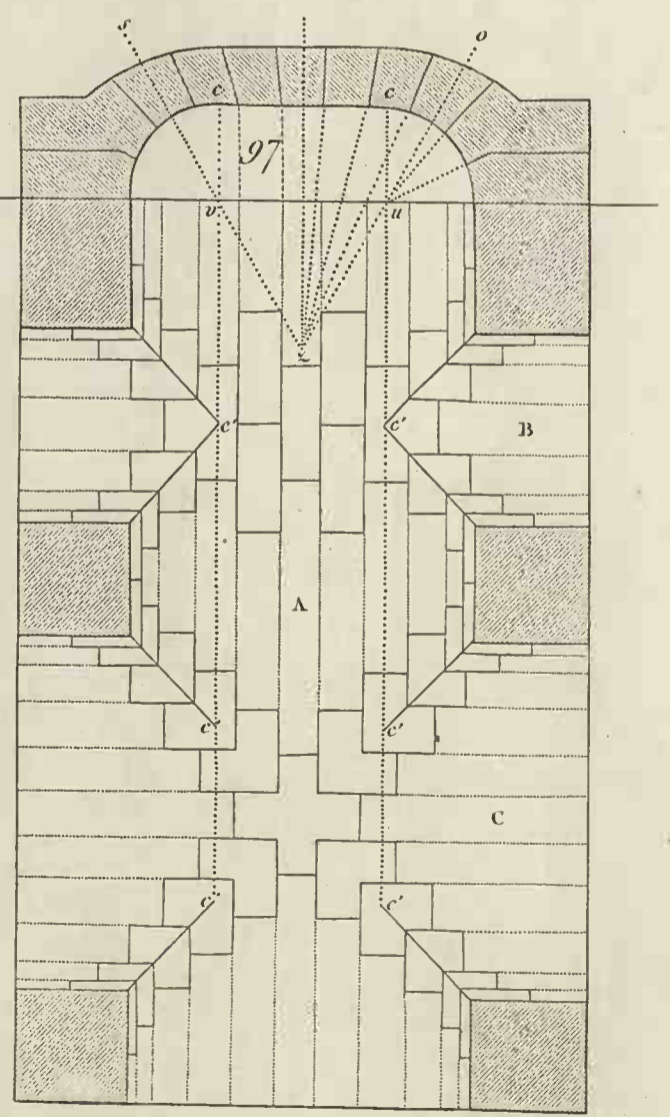
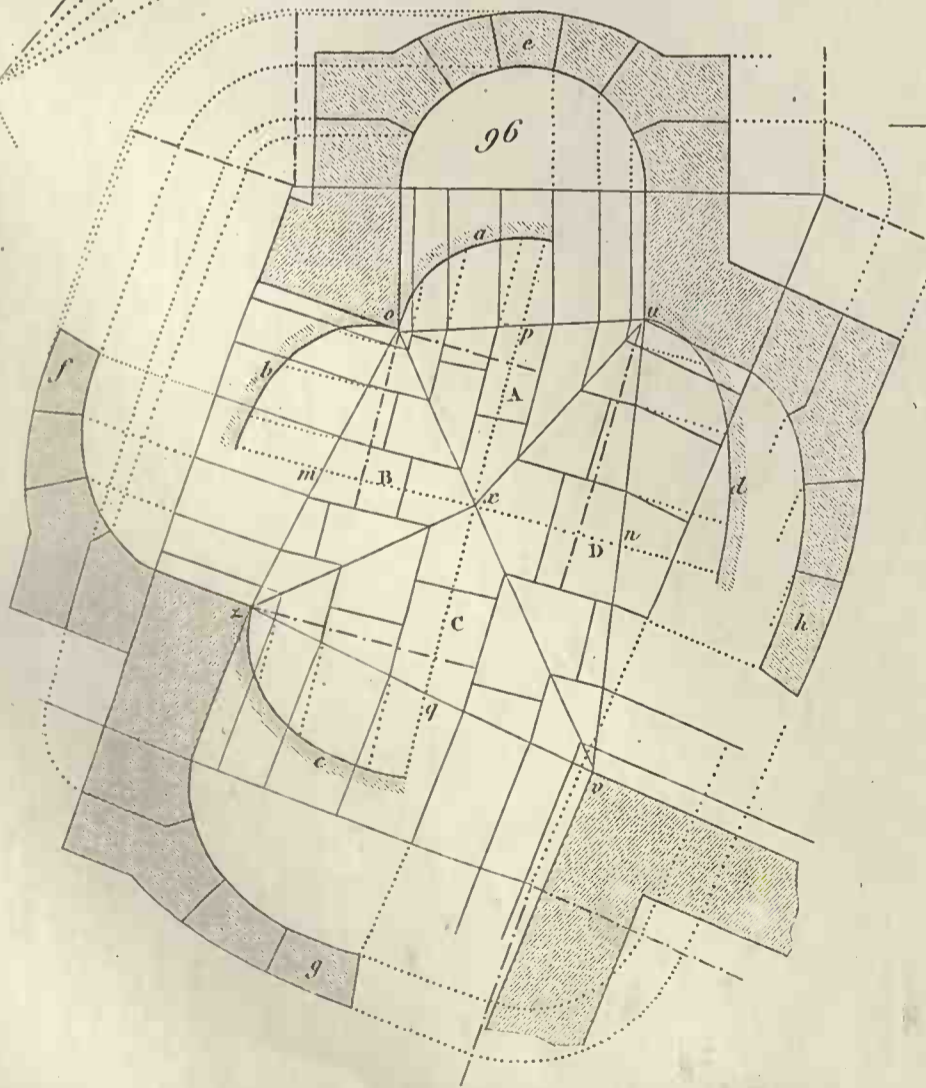
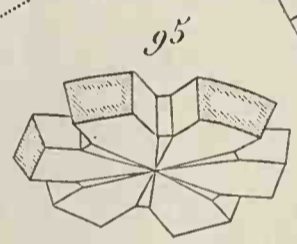
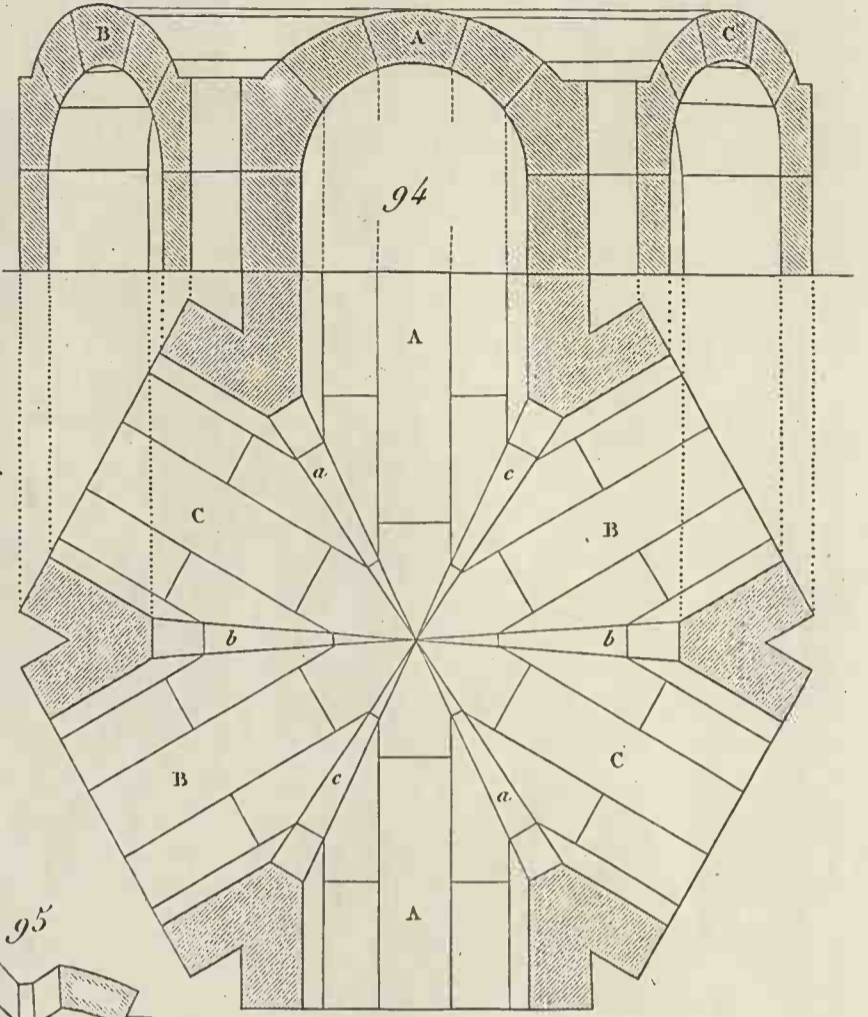
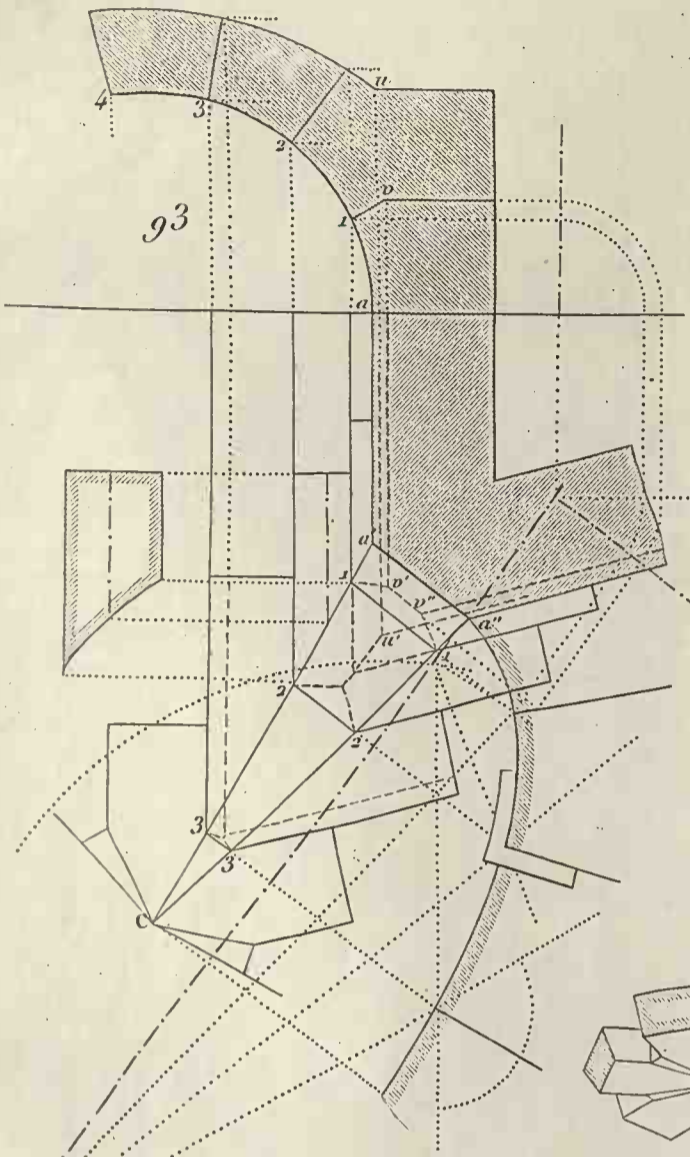


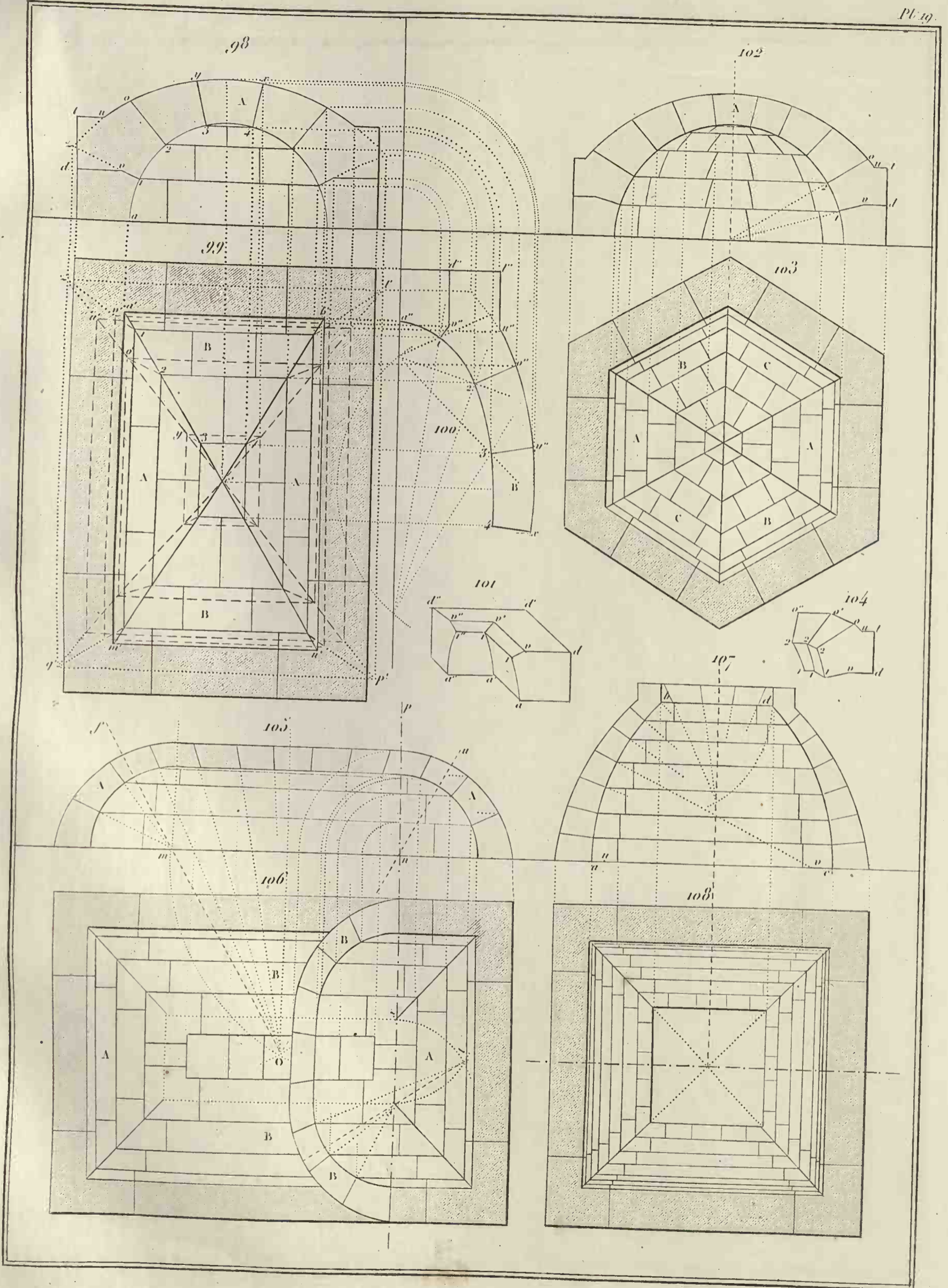


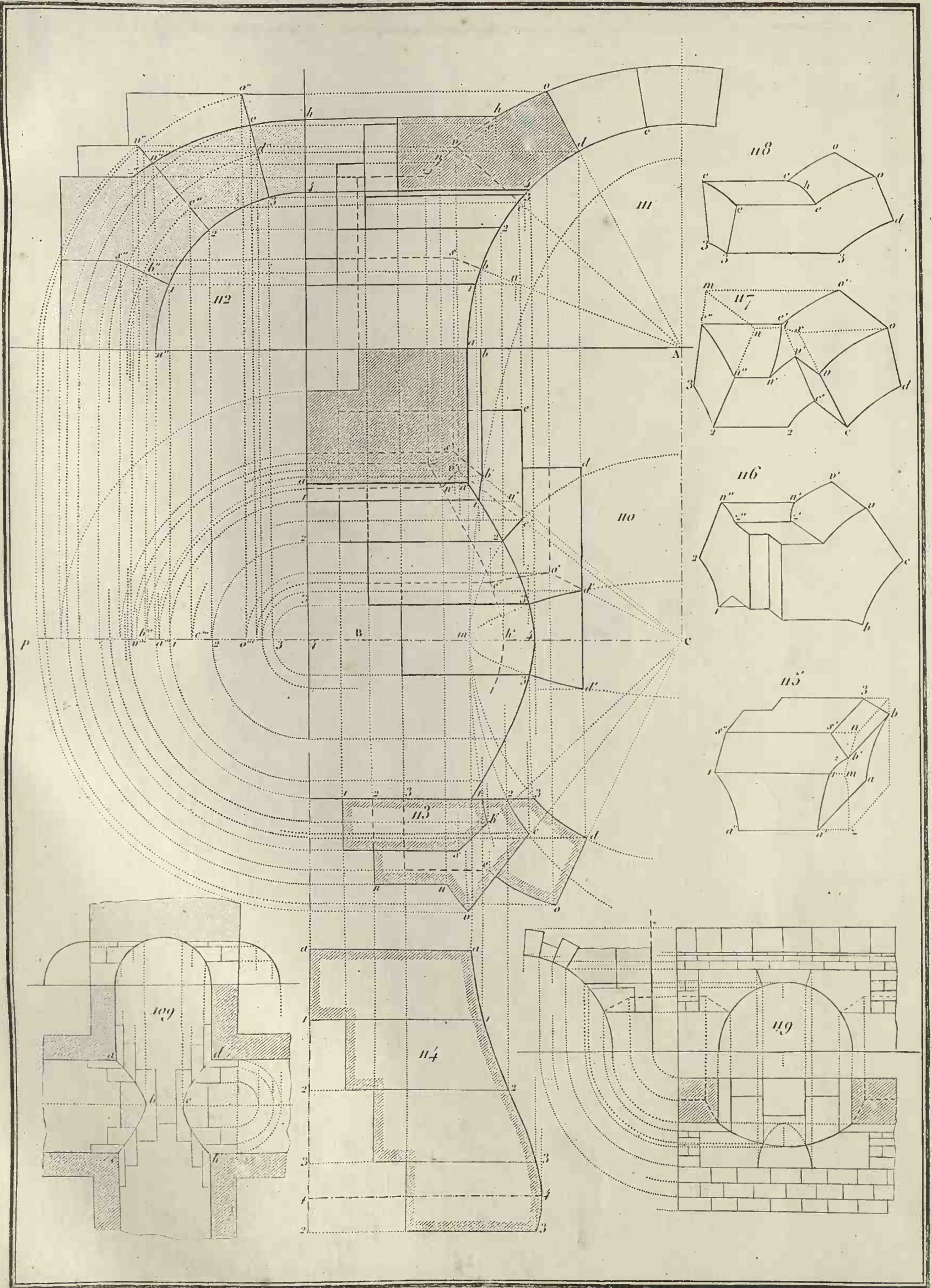
Voutes d'arrêtel.

Coupe des pierres.

Pl. 18.



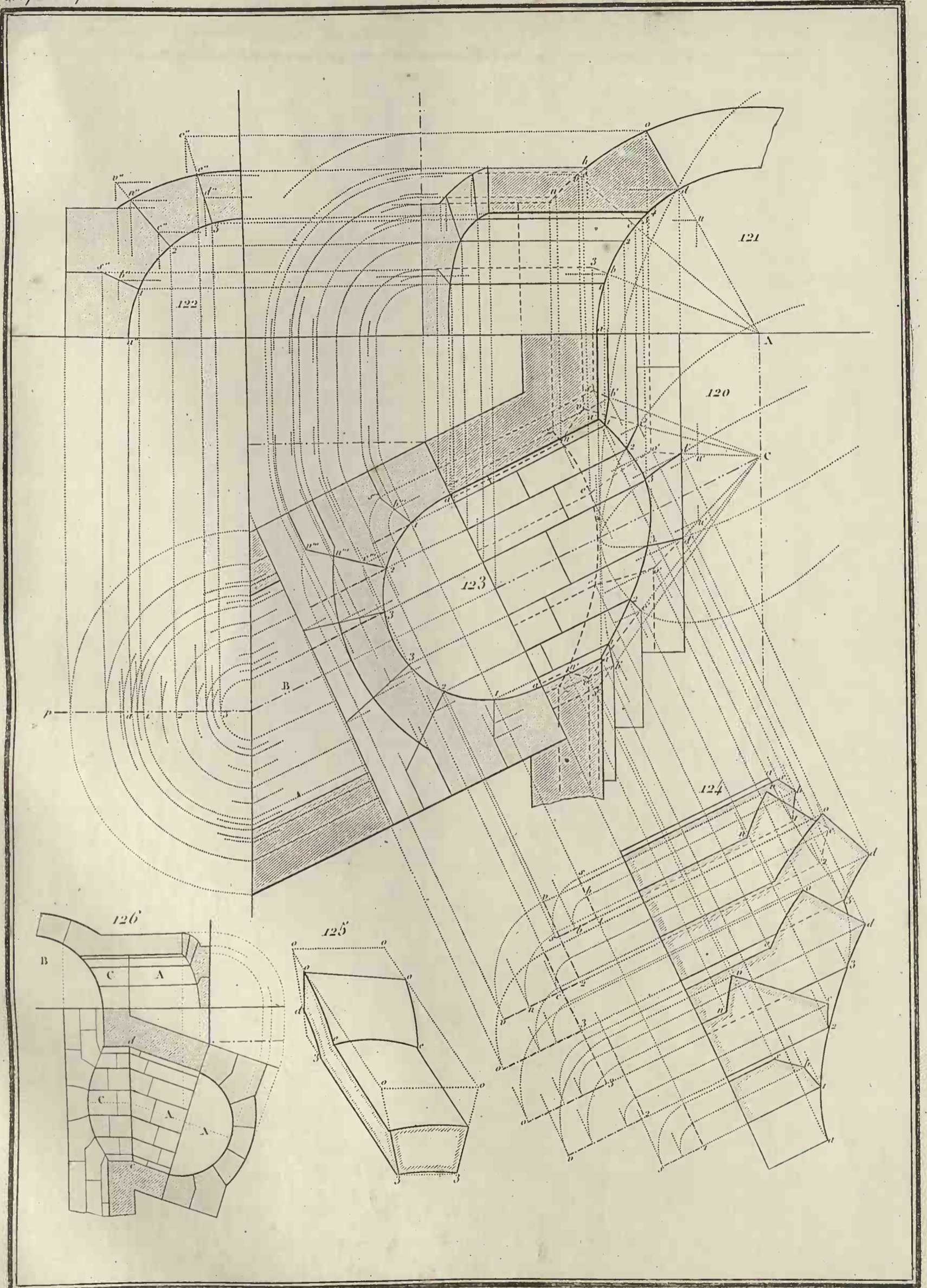




Lunette Biaise.

Coupe des pierres.

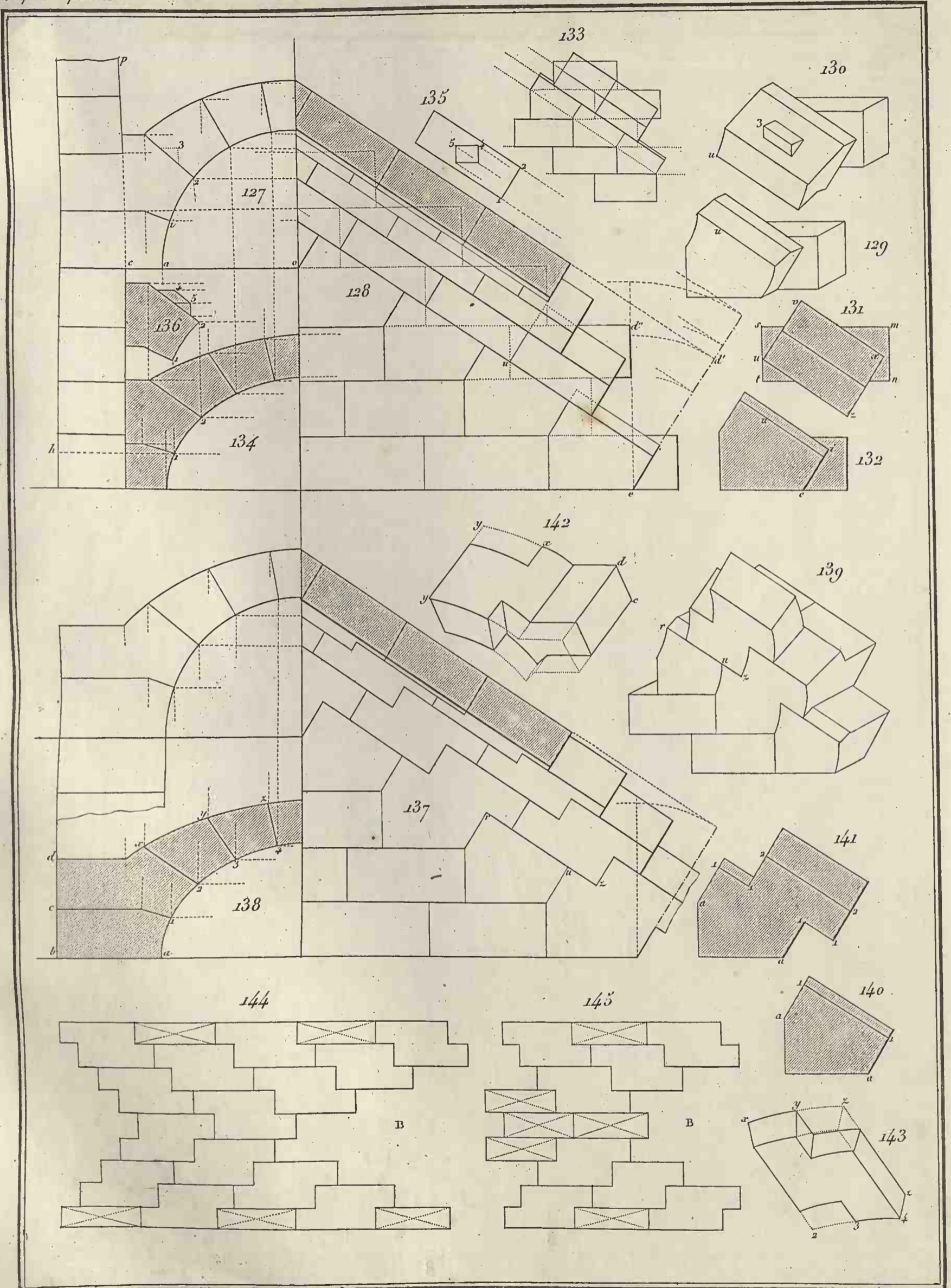
Pl. 21.

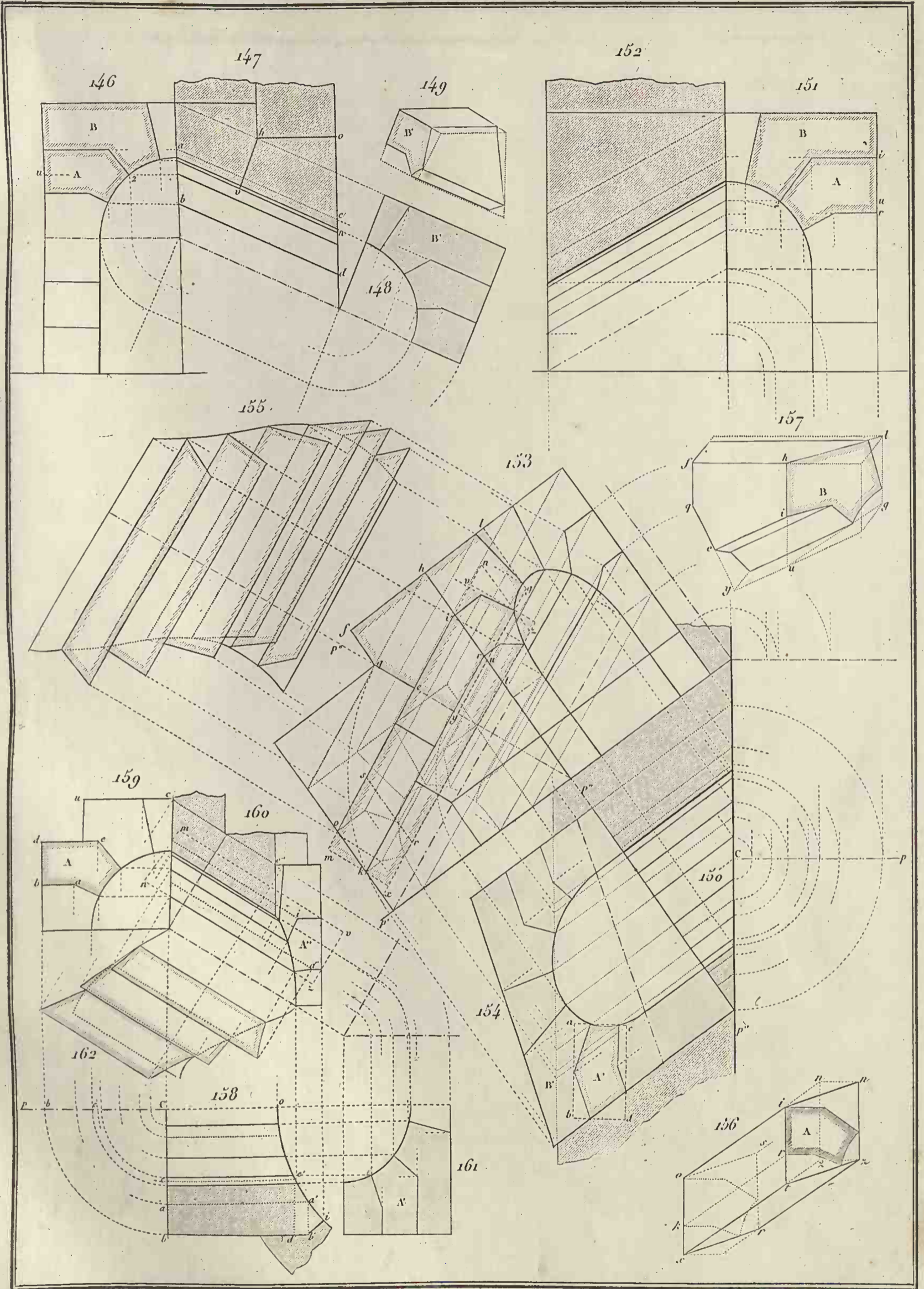


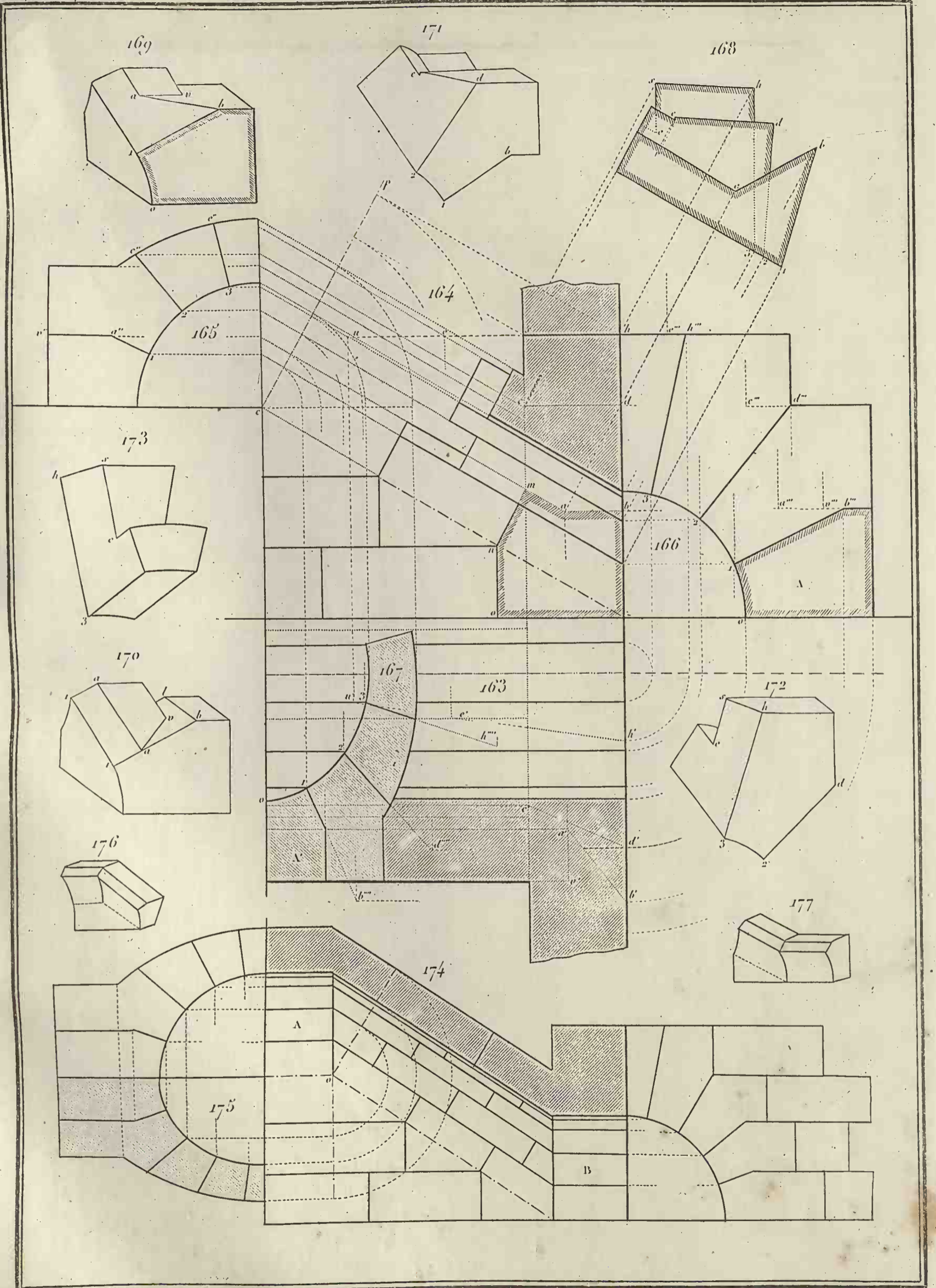
Descentes.

Coupe des pierres.

Pl. 22.



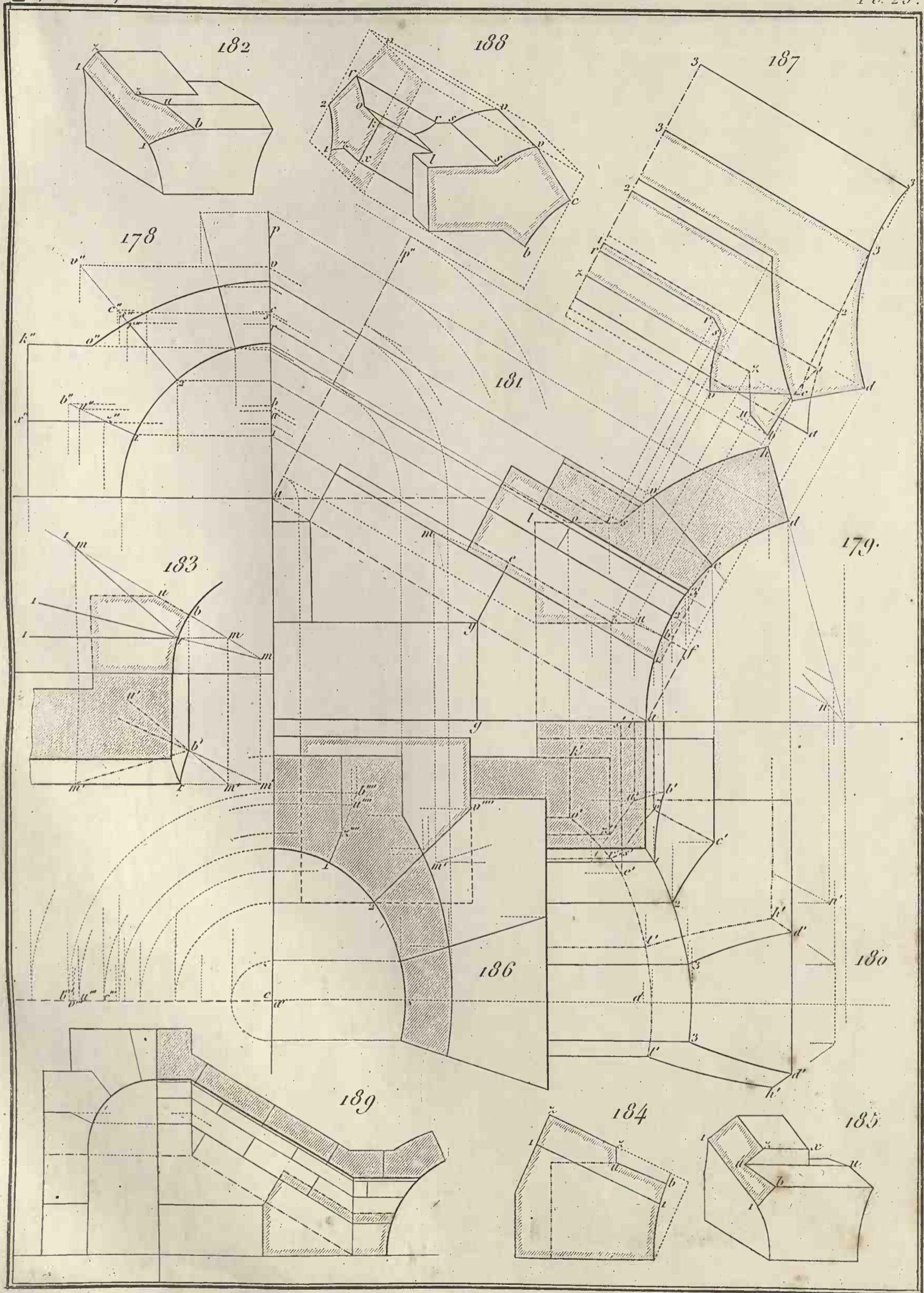




Descentes.

Coupe des pierres.

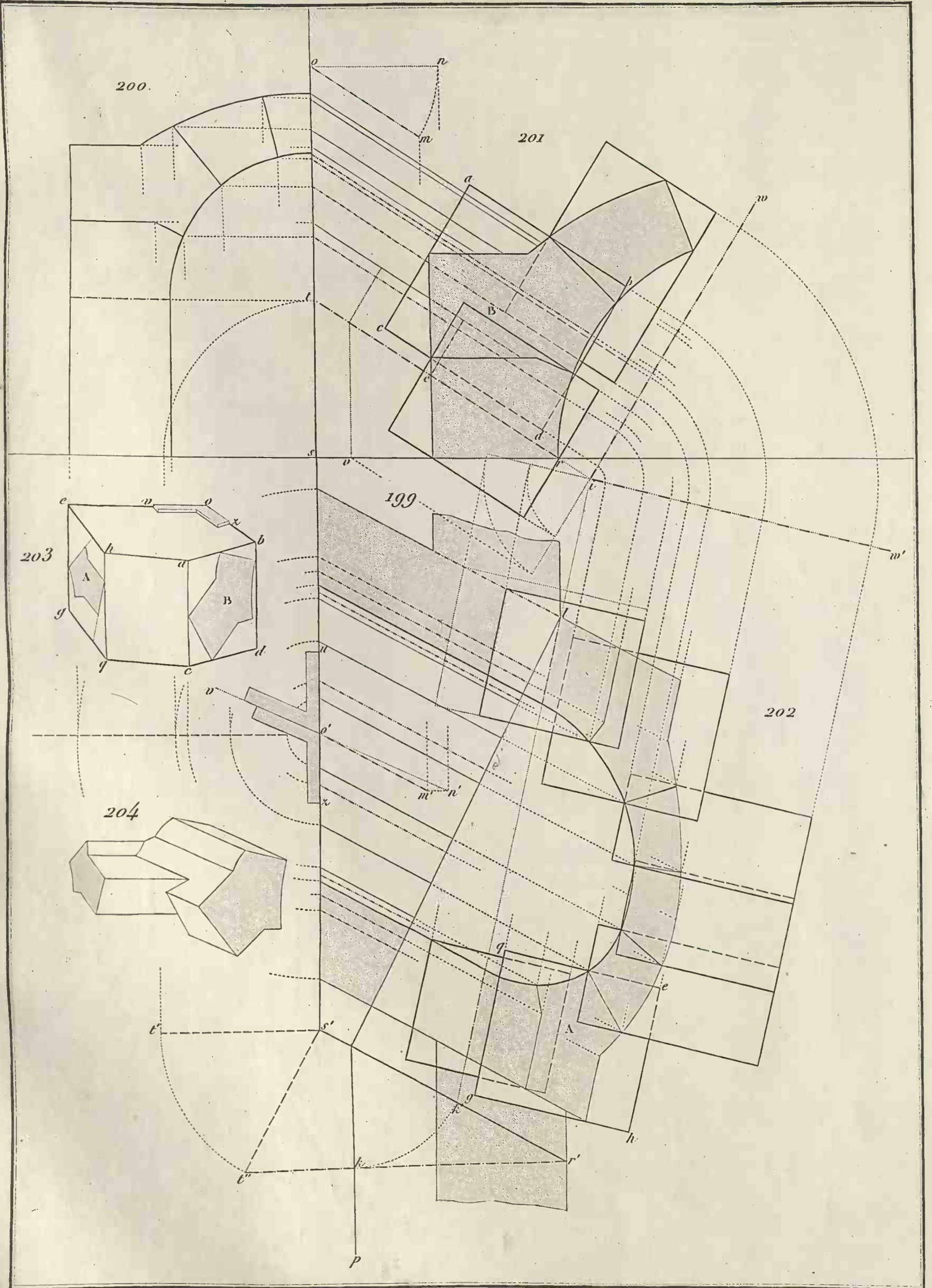
Pl. 25.



Descente biaise.

Coupe des pierres.

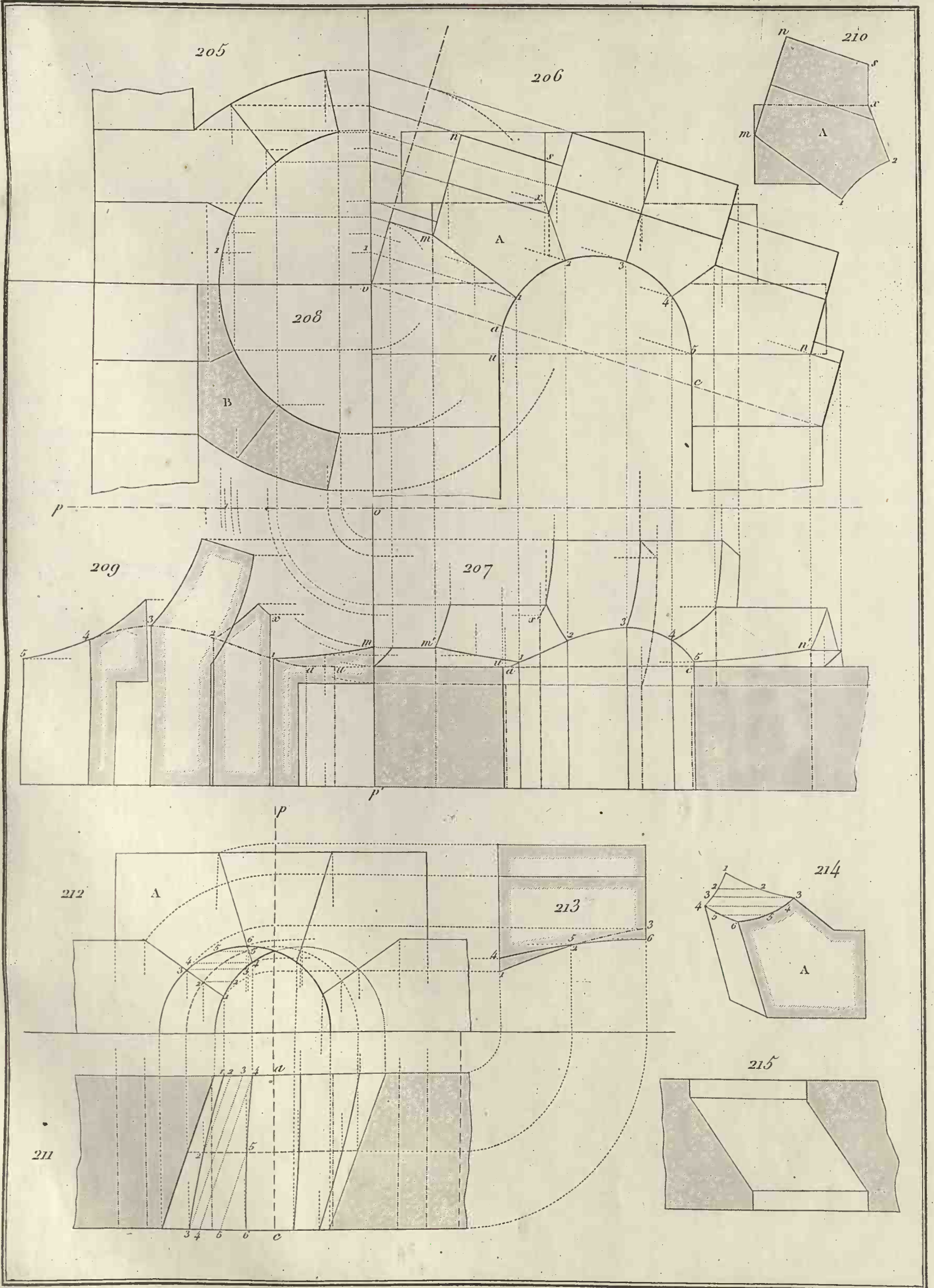
Pl. 27.



Questions diverses.

Coupe des Pierres.

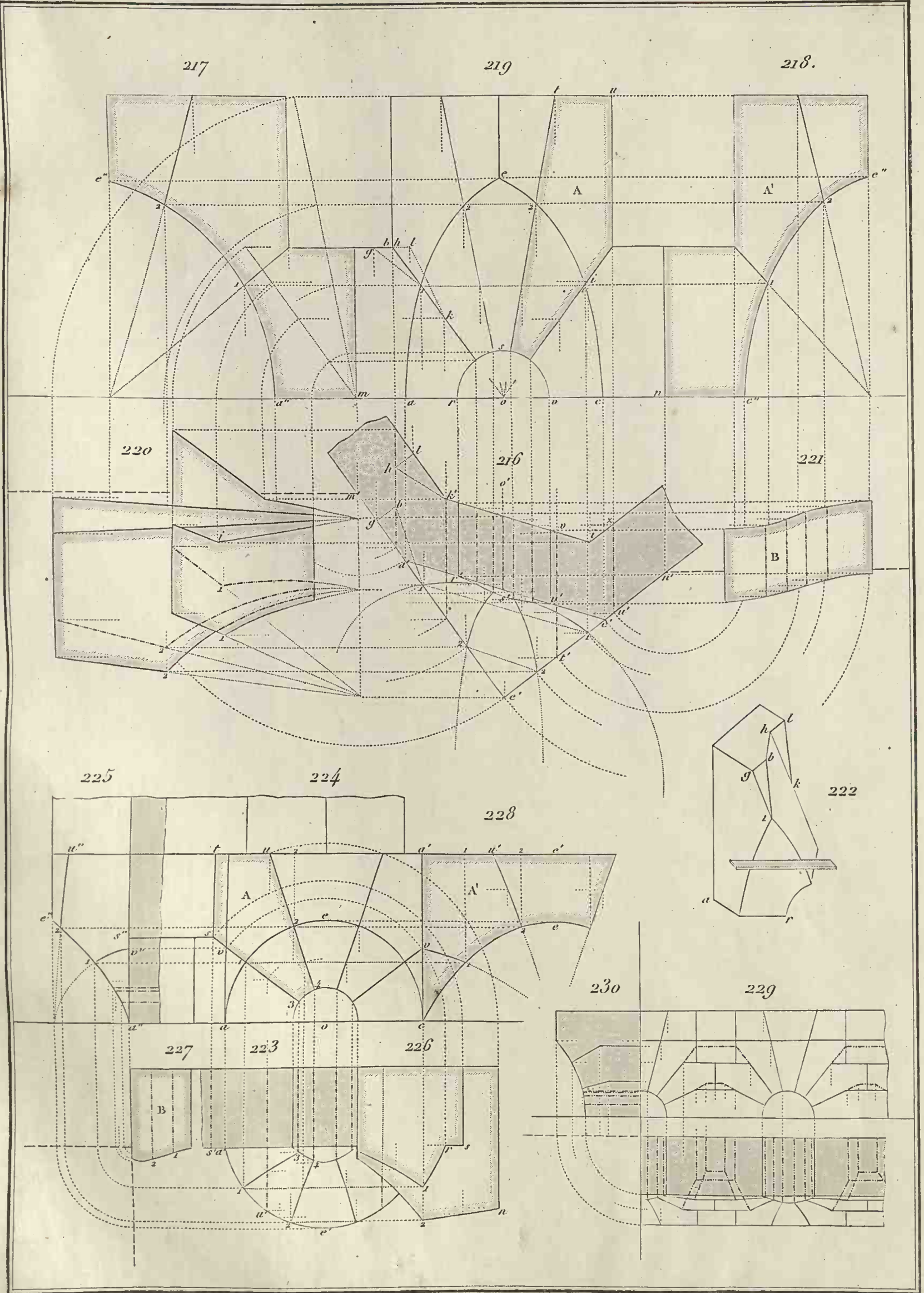
Pl. 28.



Trompes cylindriques.

Coupe des pierres.

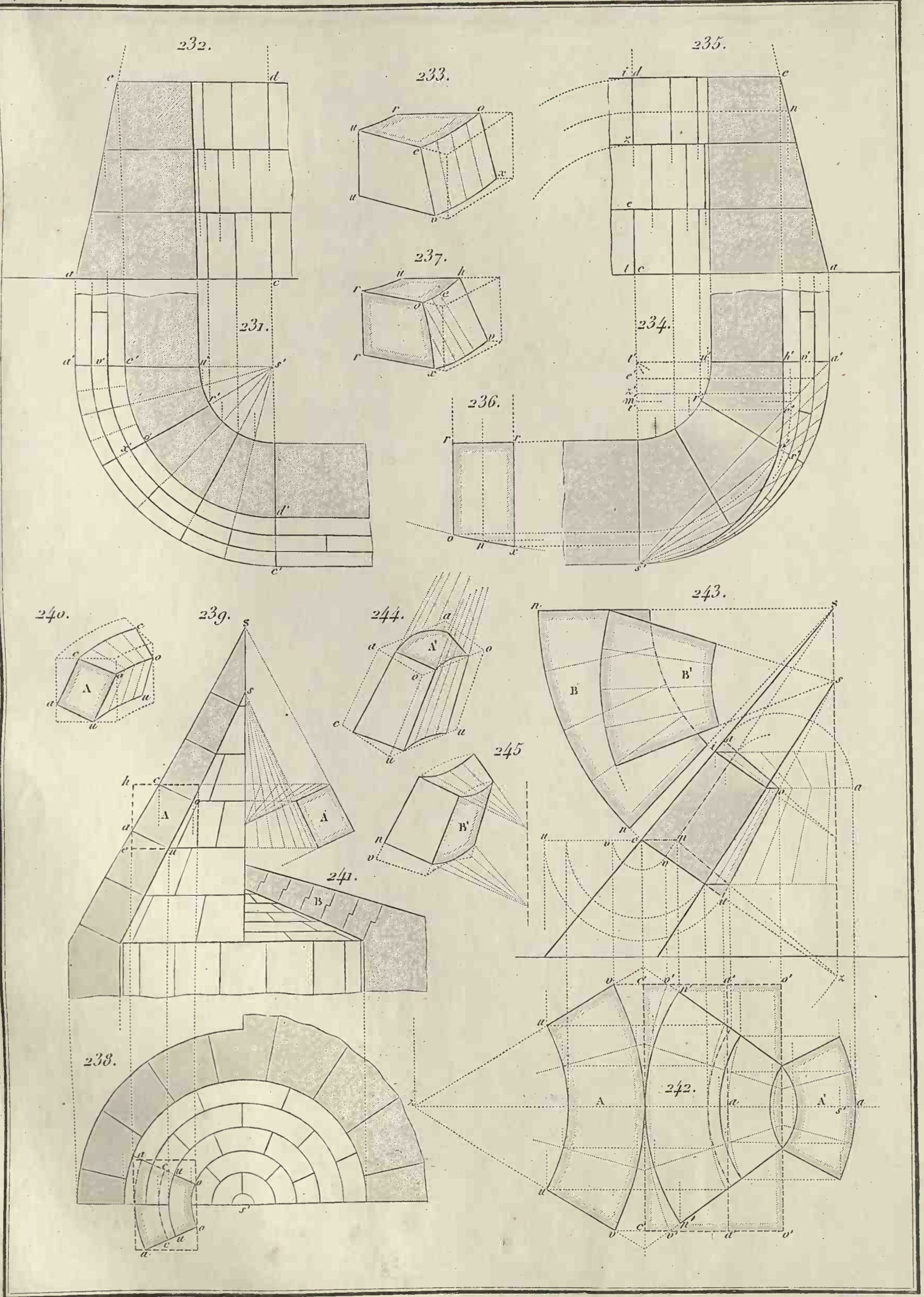
Pl. 29.



Murs et Voutes coniques.

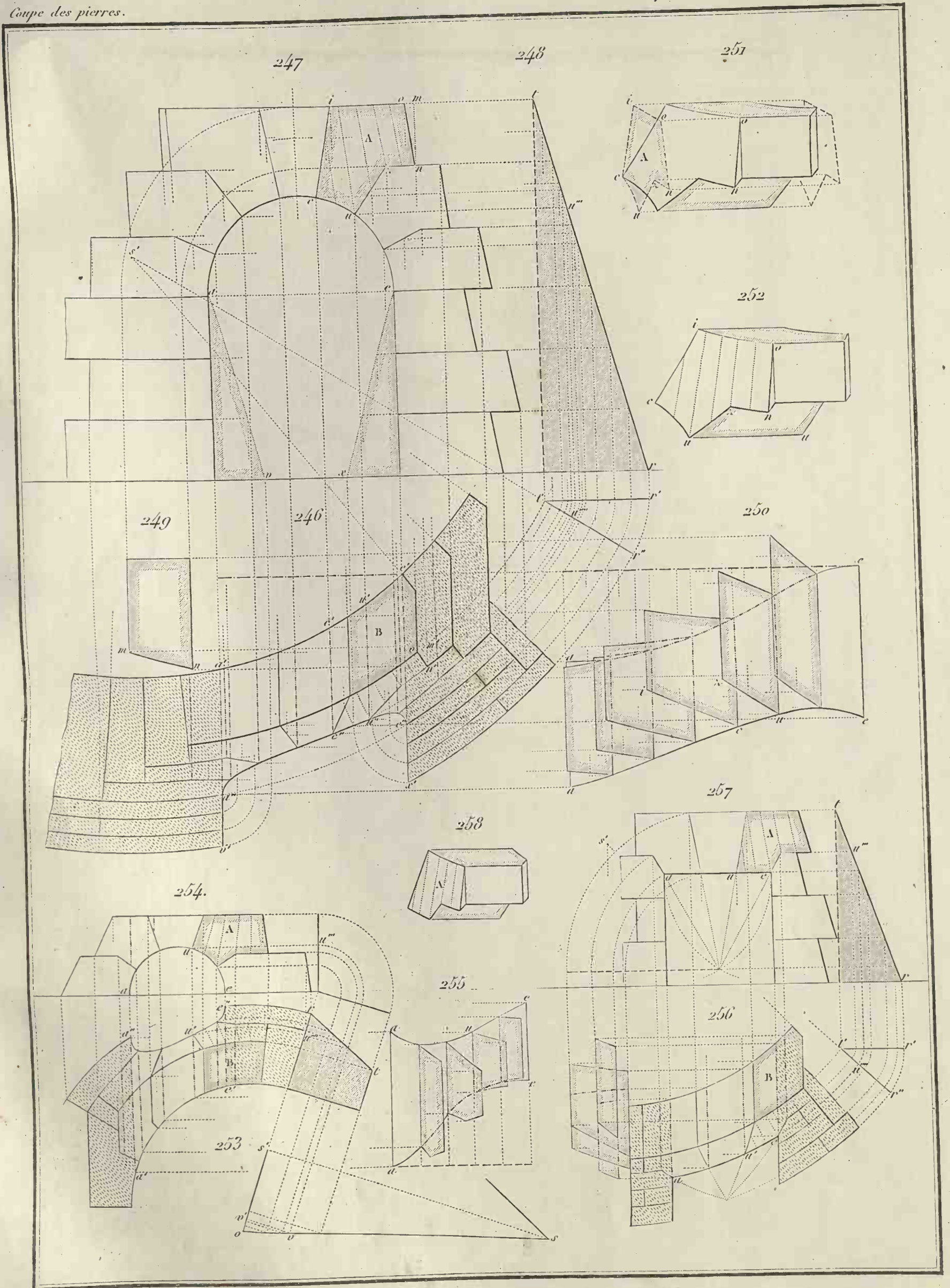
Coupe des pierres.

Pl. 30.



Porte biaisée dans un mur conique.

Coupe des pierres.

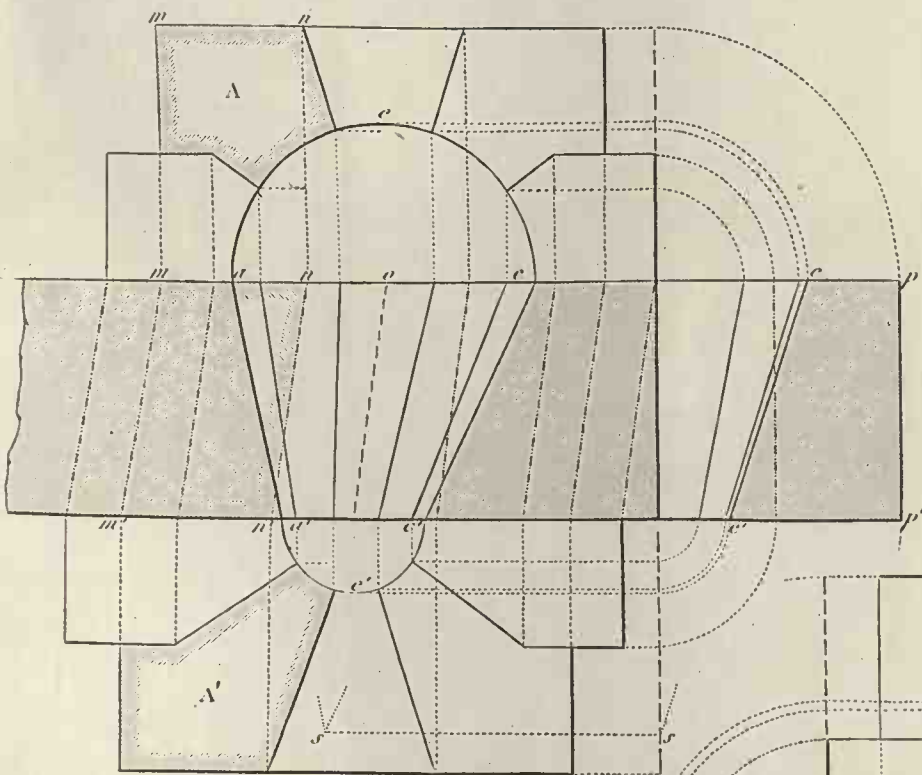


Portes coniques.

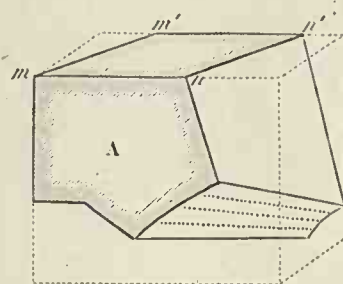
Coupe des pierres.

Pl. 32.

259.

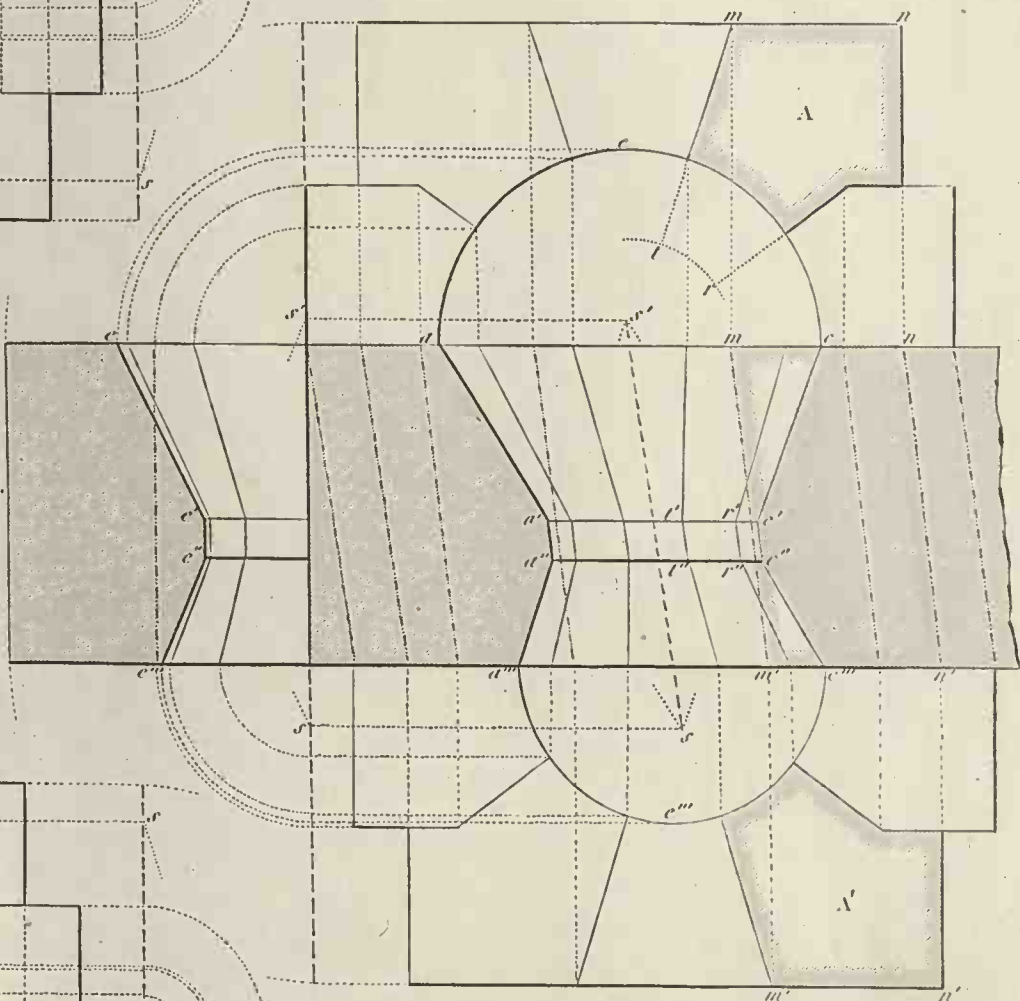


261.

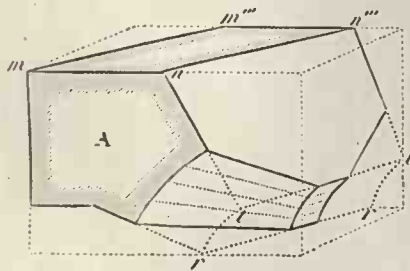


260.

262.

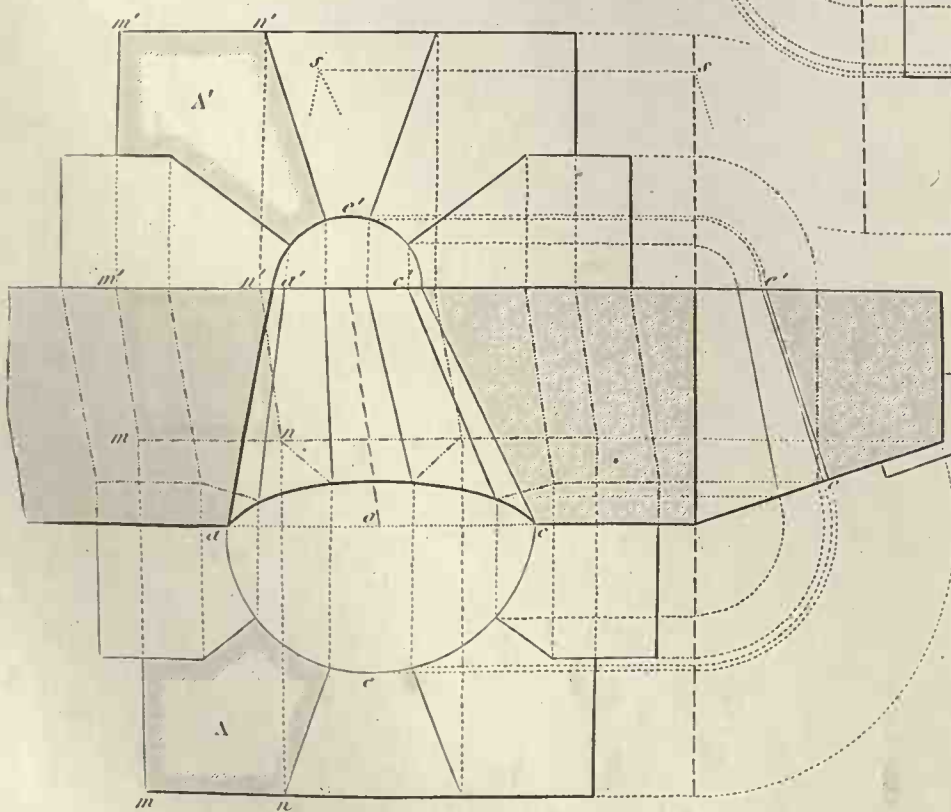


264.



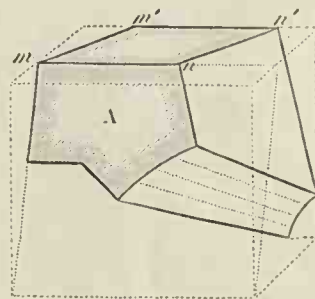
263.

265.



266.

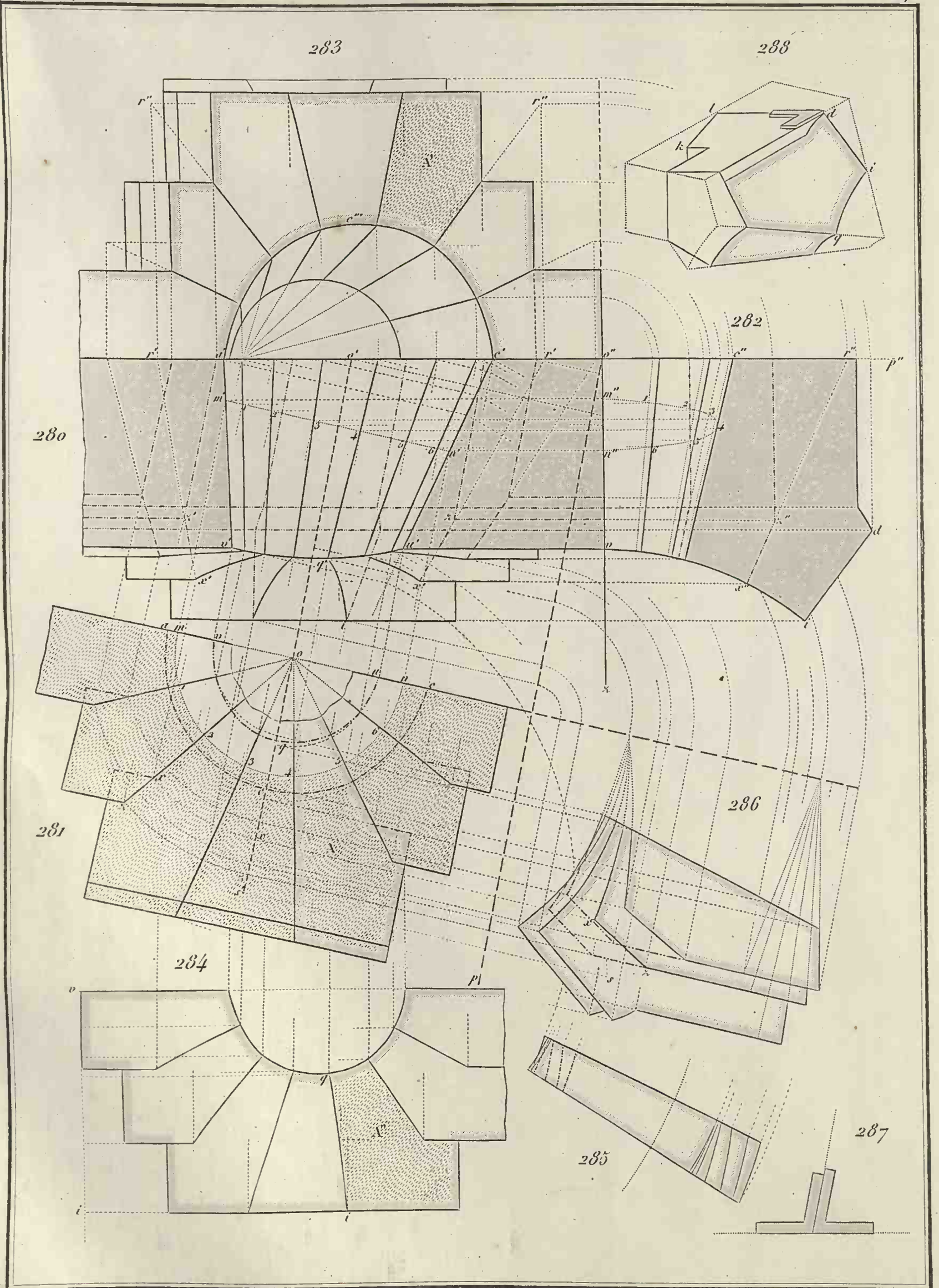
267.



Lunette conique biaise.

Coupe des pierres.

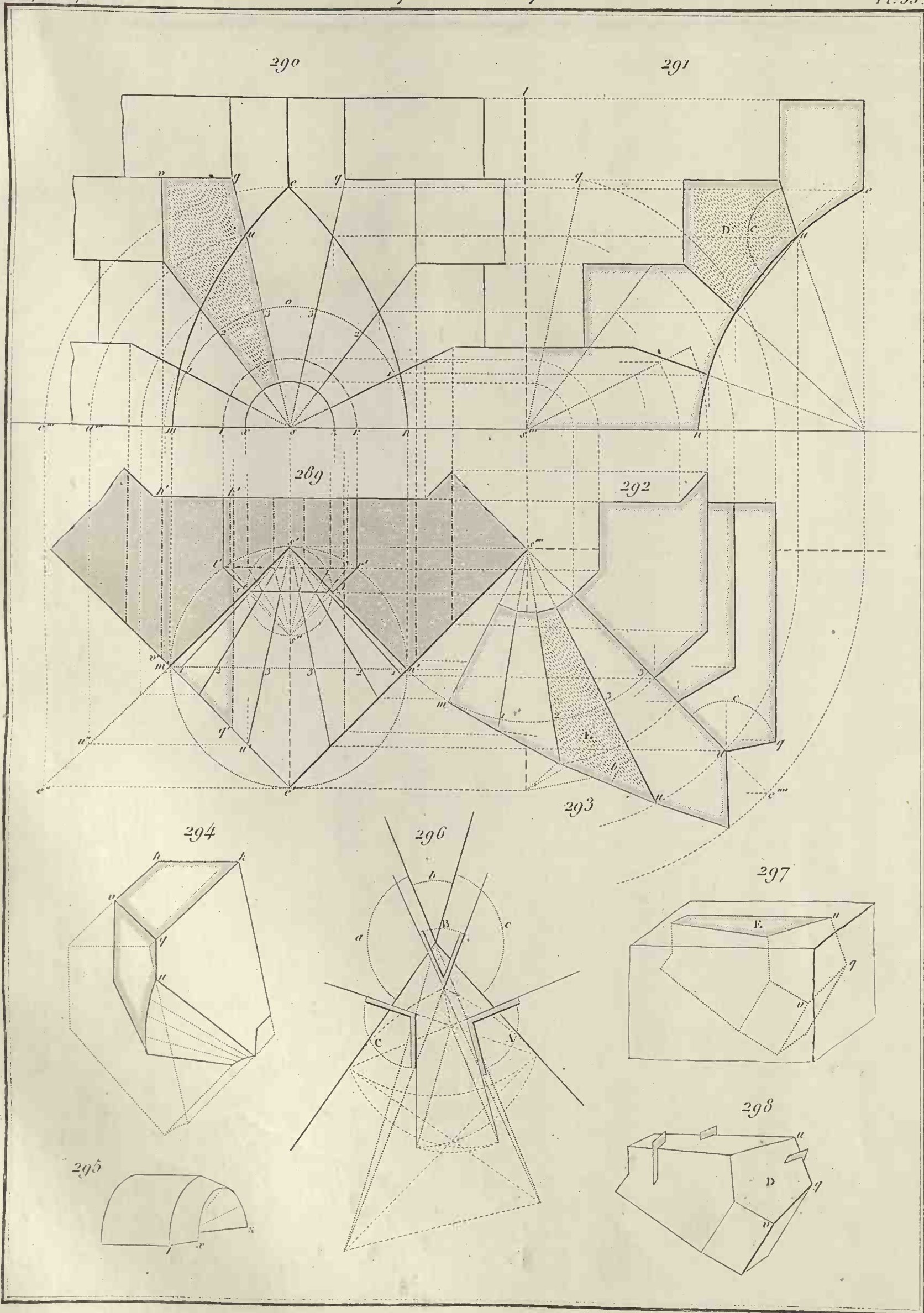
Pl. 34.



Couronne conique.

Coupe des pierres.

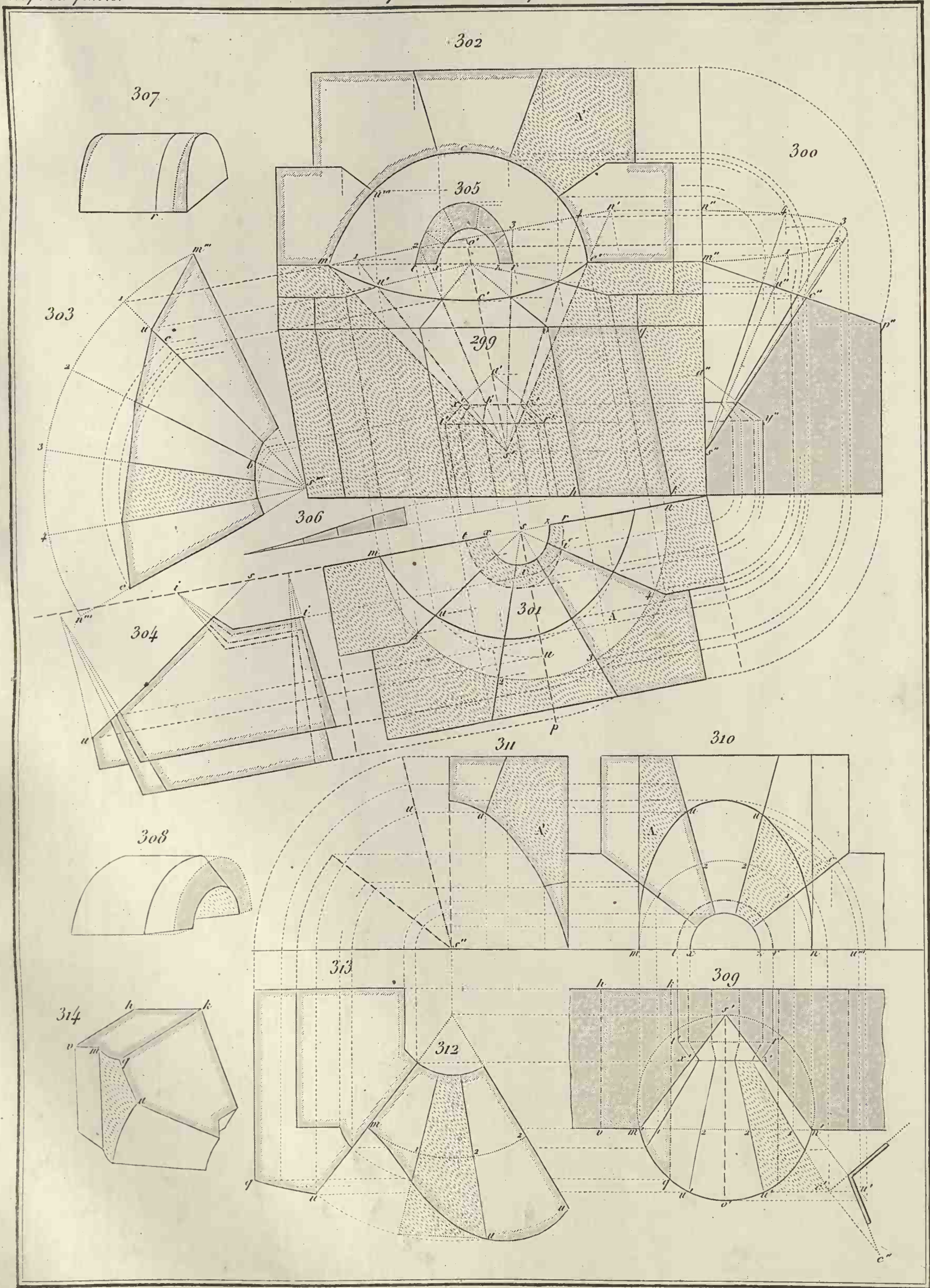
Pl. 35.



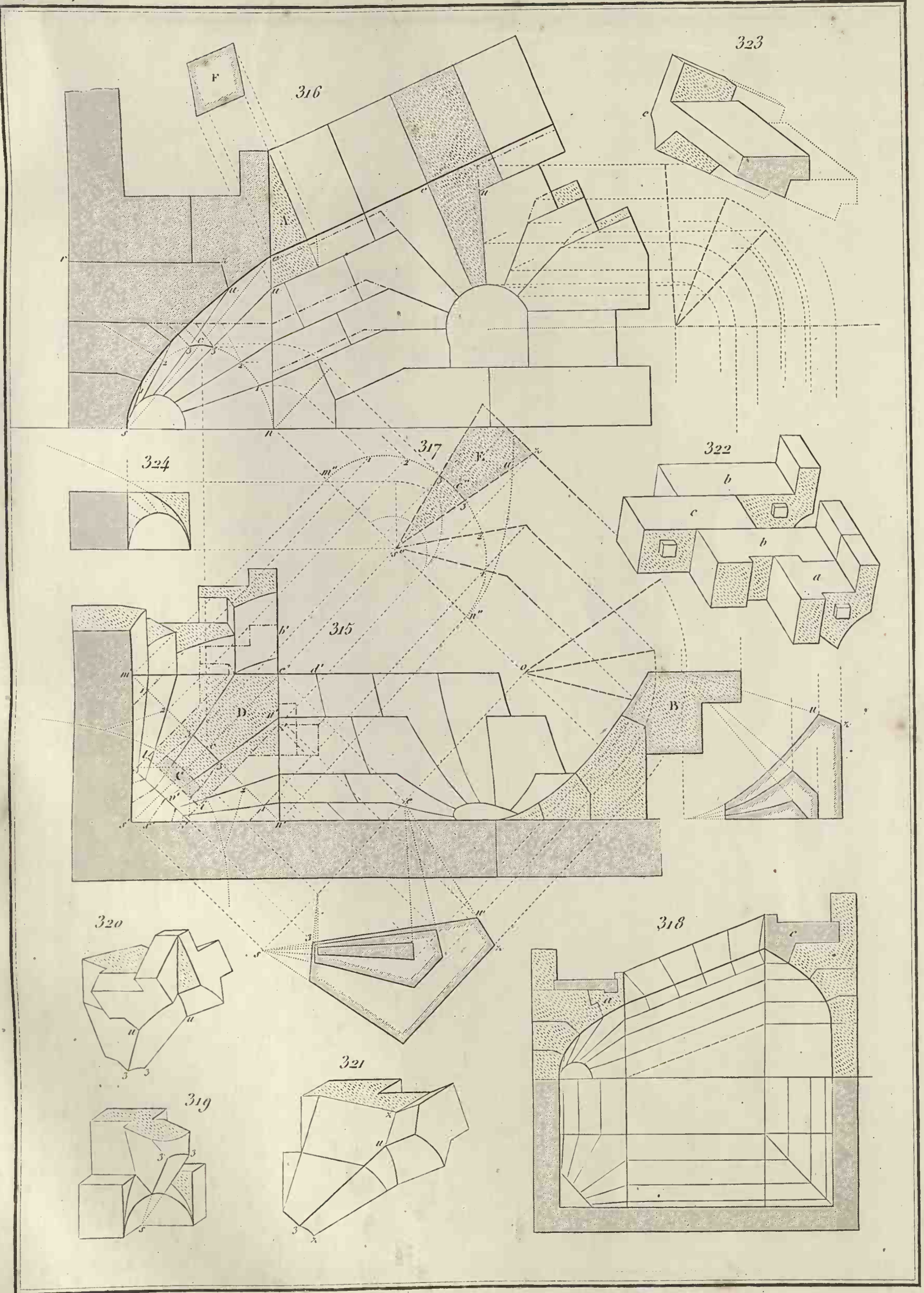
Crompes coniques.

Coupe des pierres.

Pl. 36.



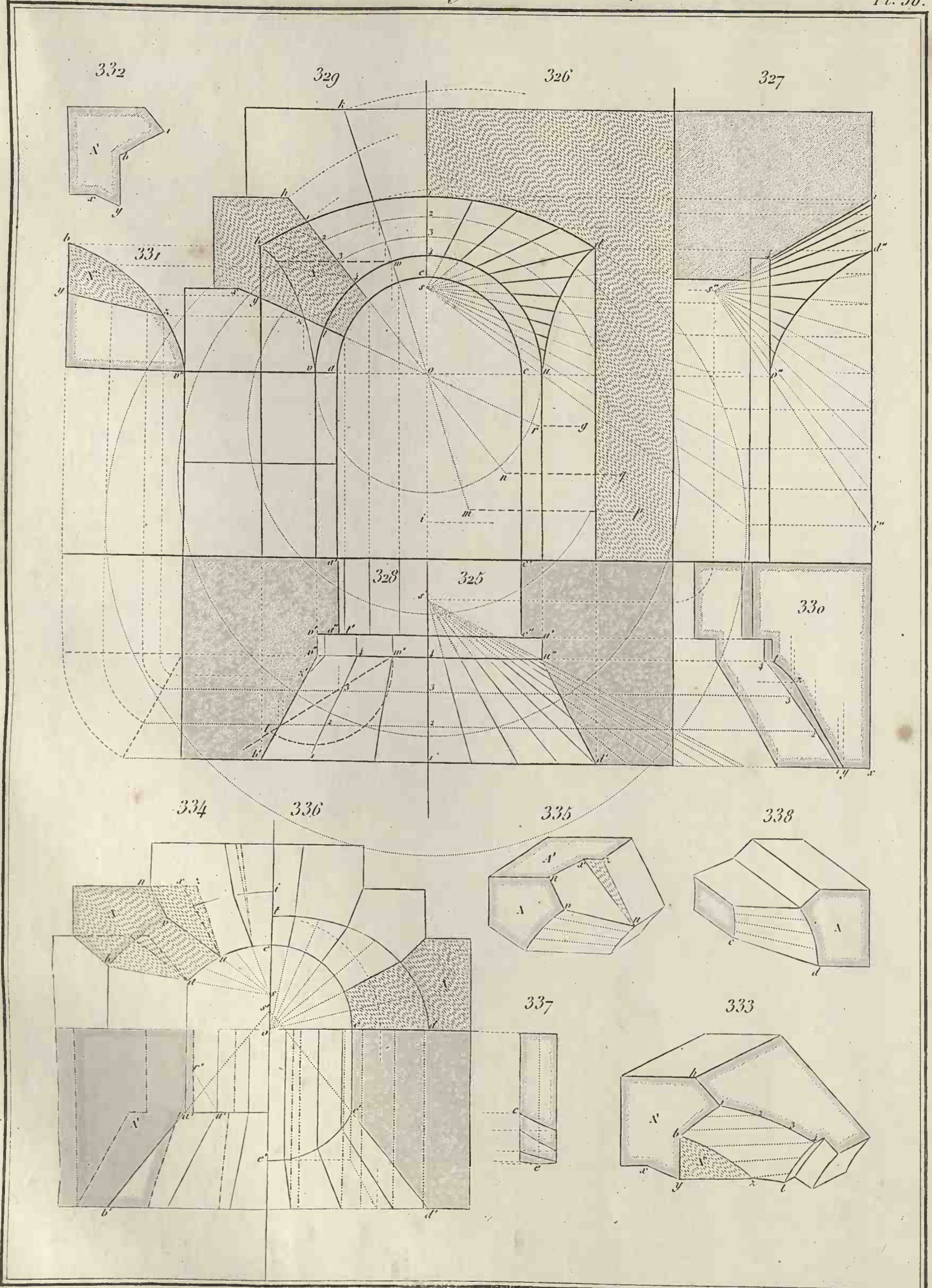
Coupe des pierres.

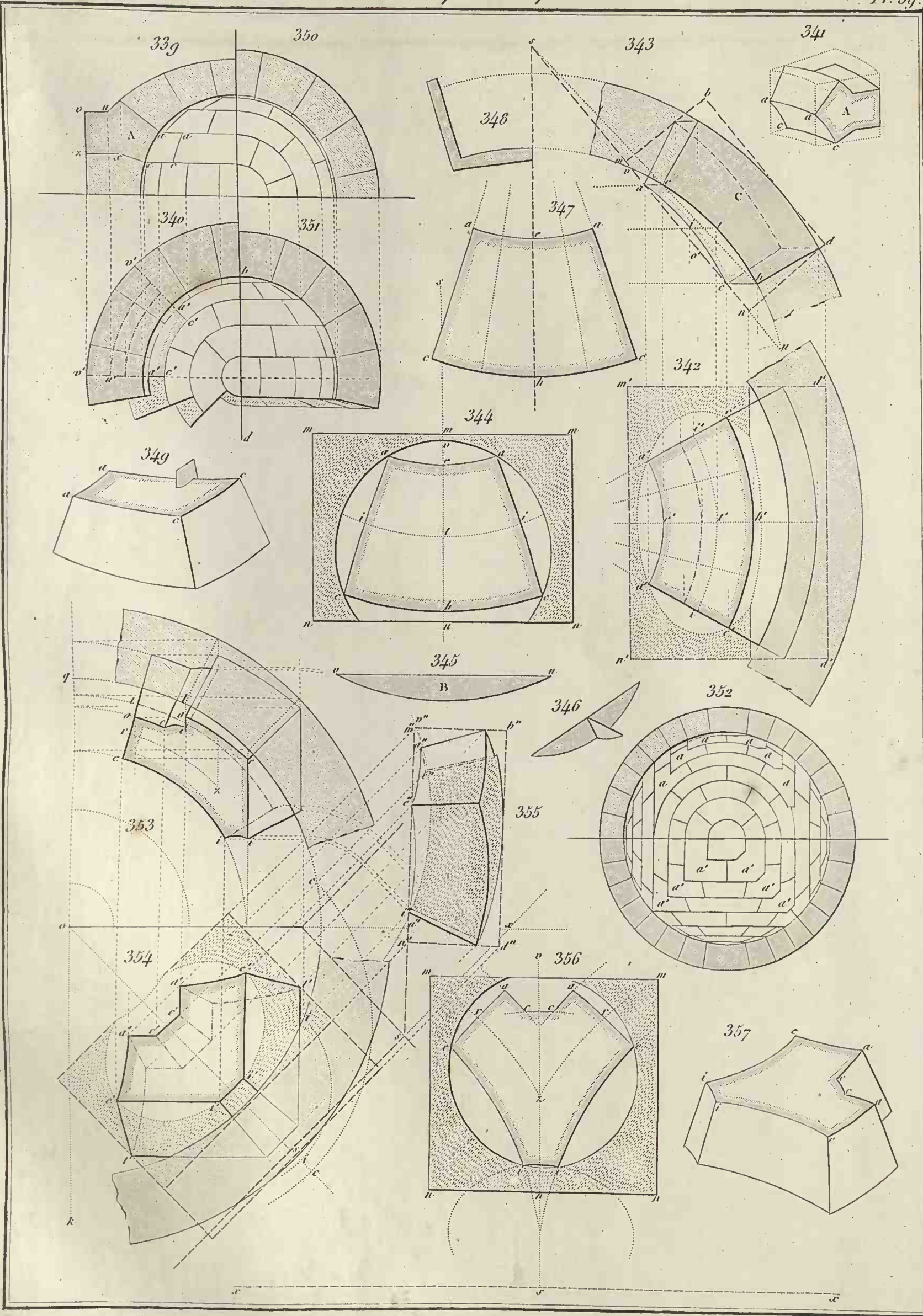


Arrière voussure conique.

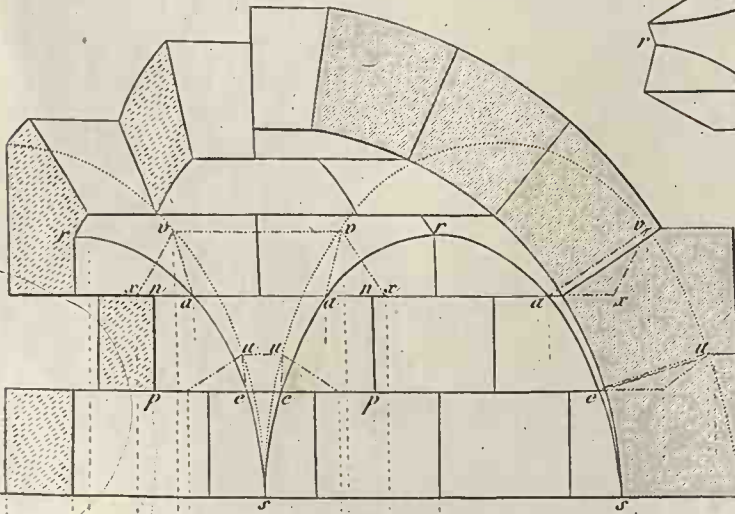
Coupe des pierres.

Pl. 38.

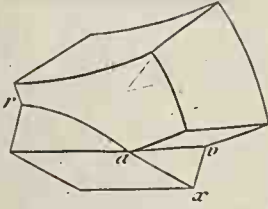




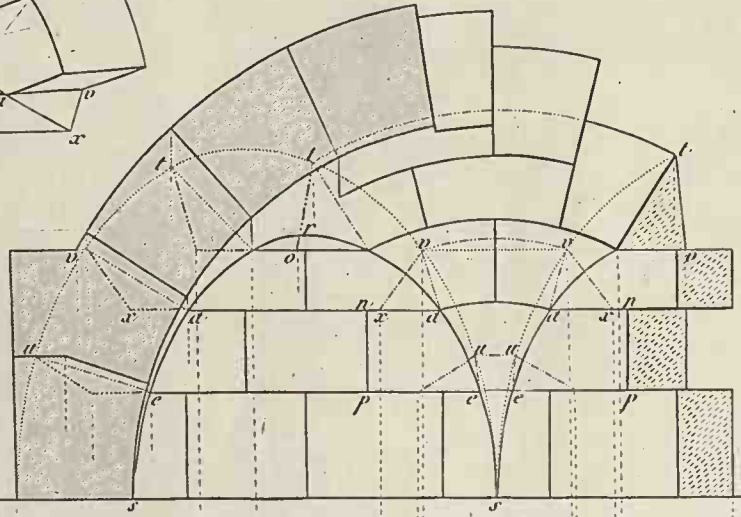
359



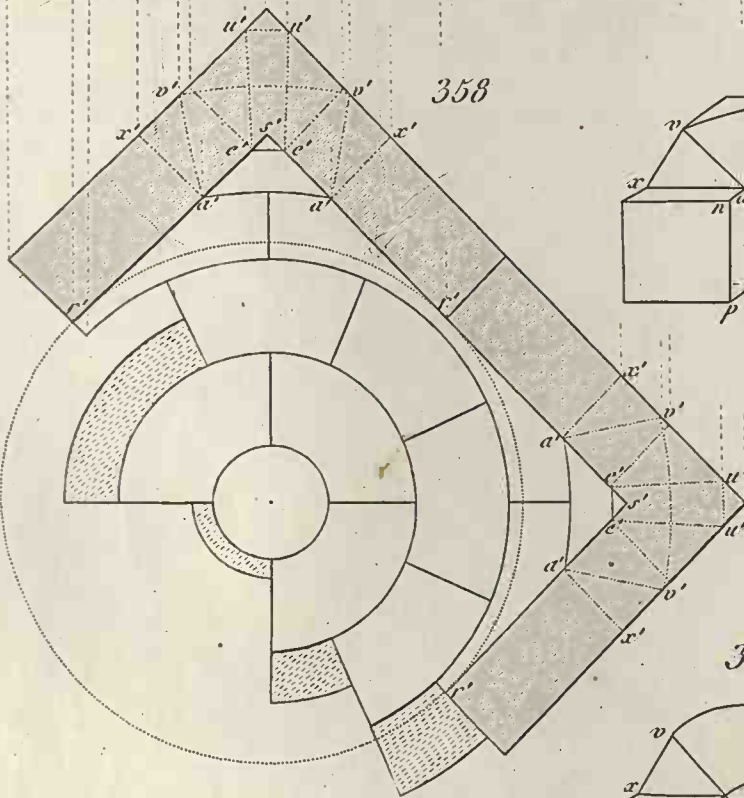
362



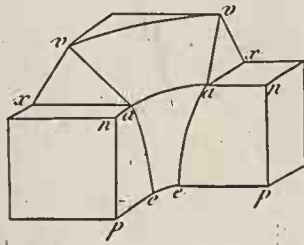
365



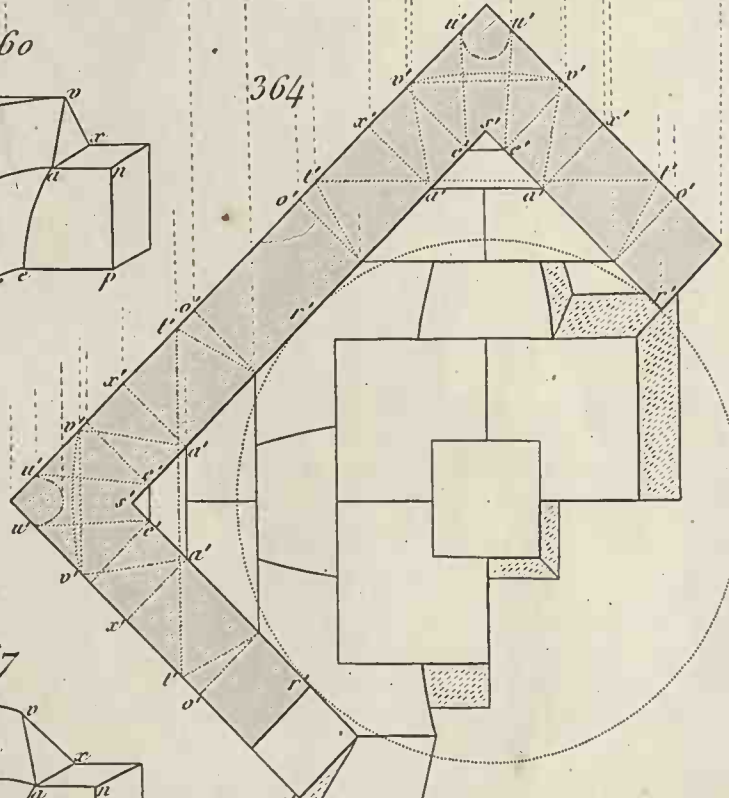
358



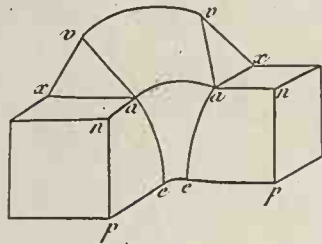
360



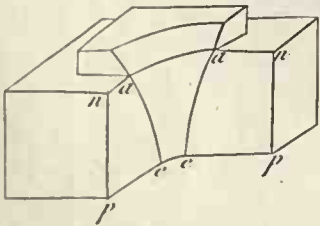
364



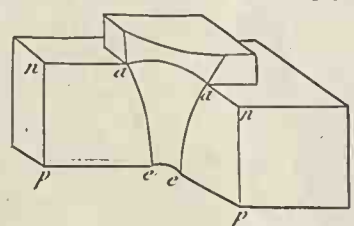
367



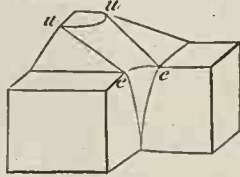
361



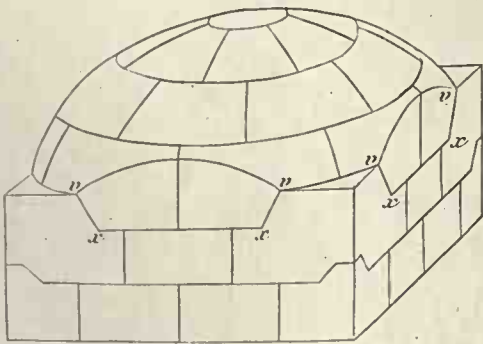
368



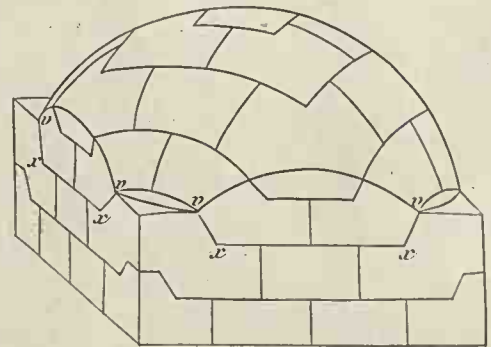
366



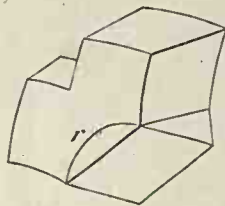
363



370



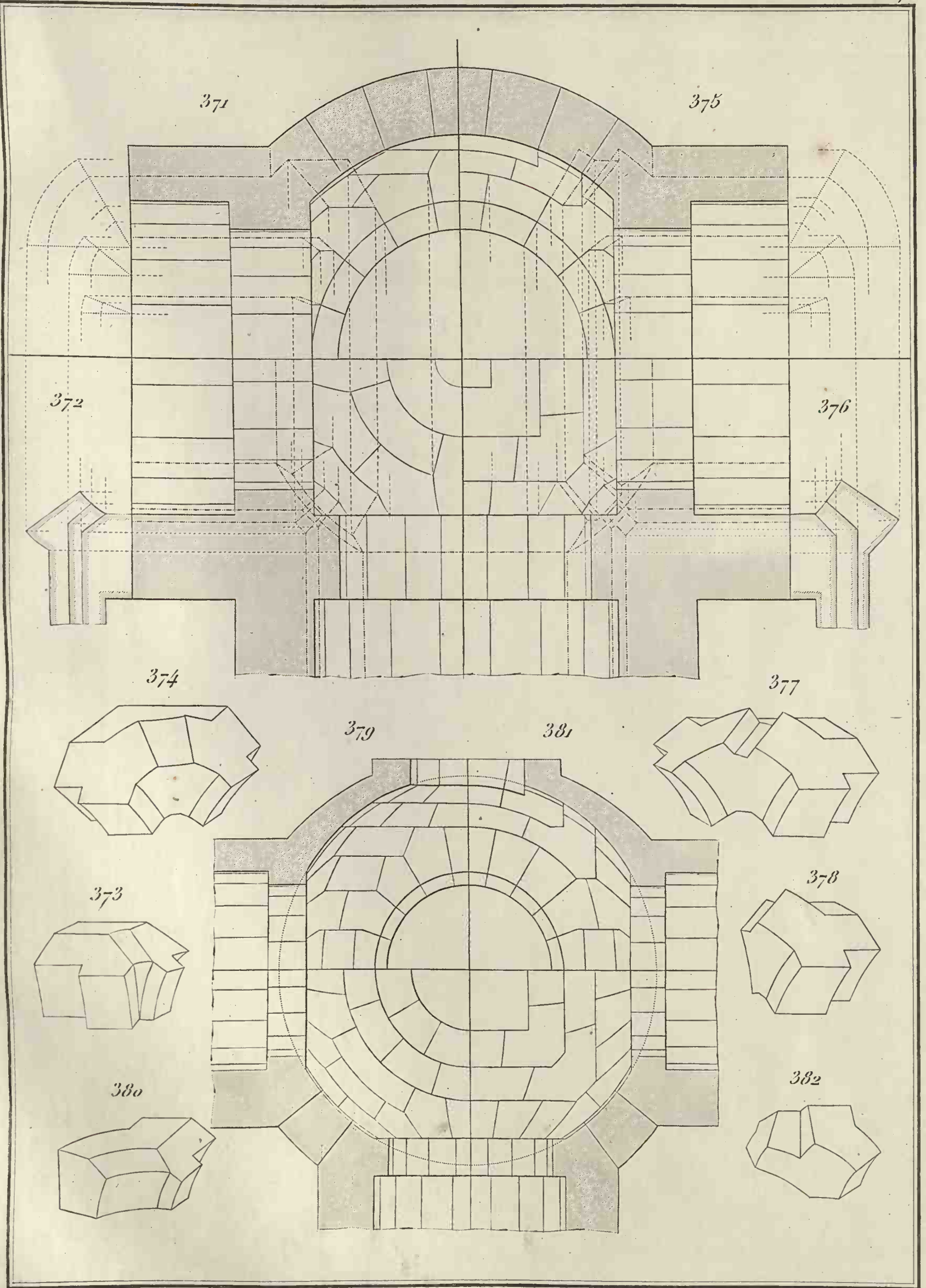
369



Pendentifs.

Coupe des pierres.

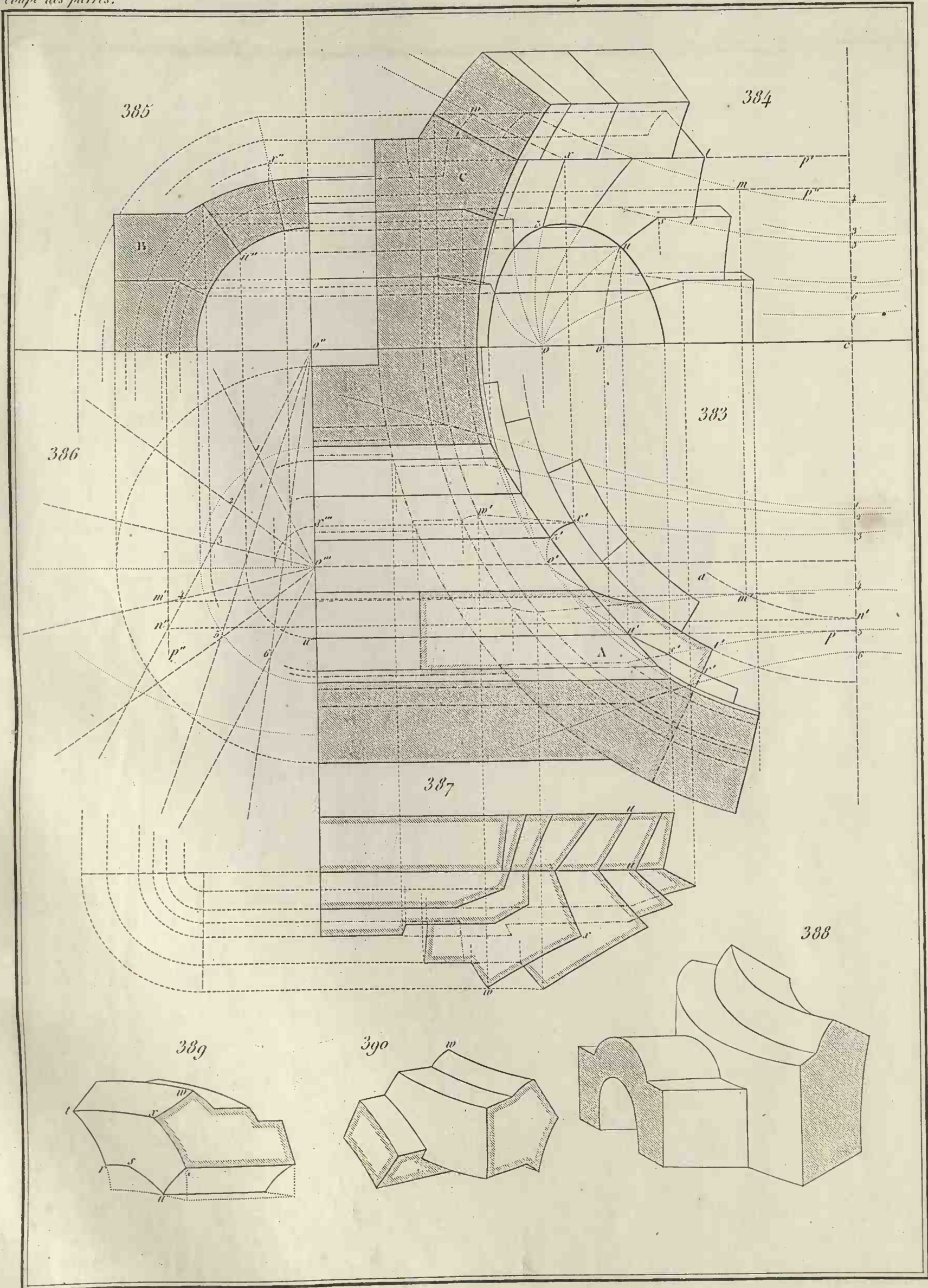
Pl. 41.



Lunette dans une Voute spherique.

Coupe des pierres.

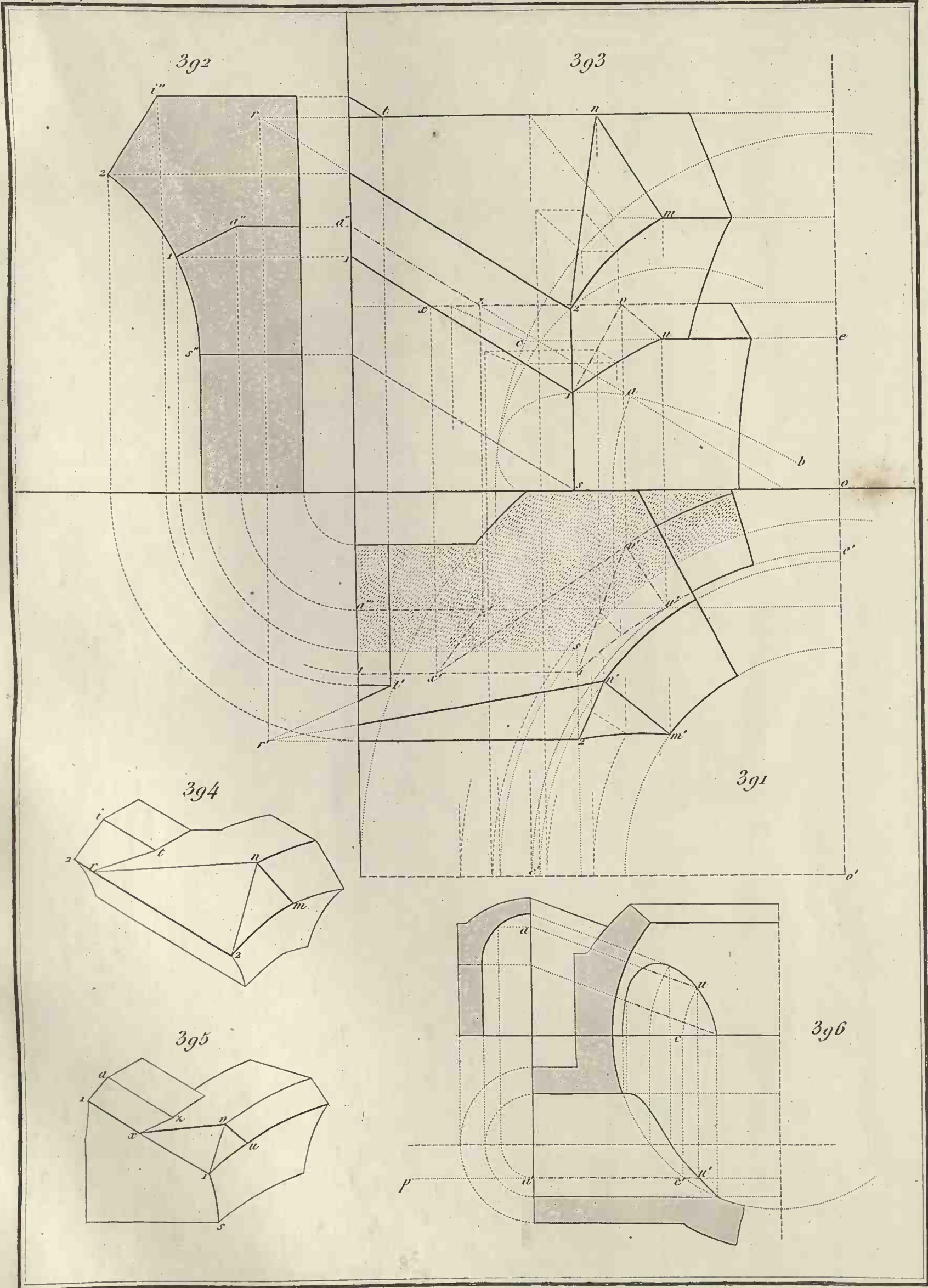
Pl. 42.



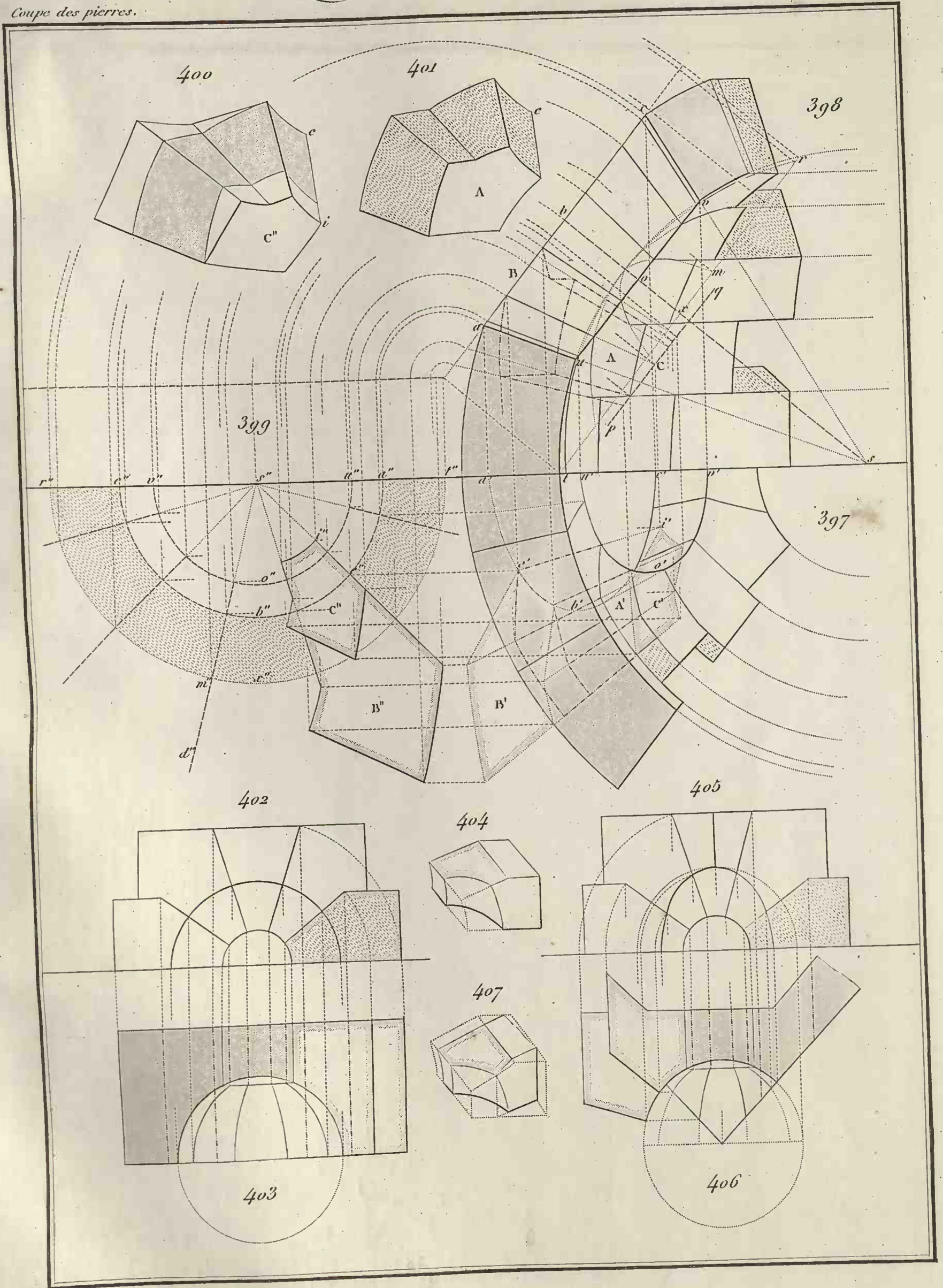
Descente dans une Voute spherique.

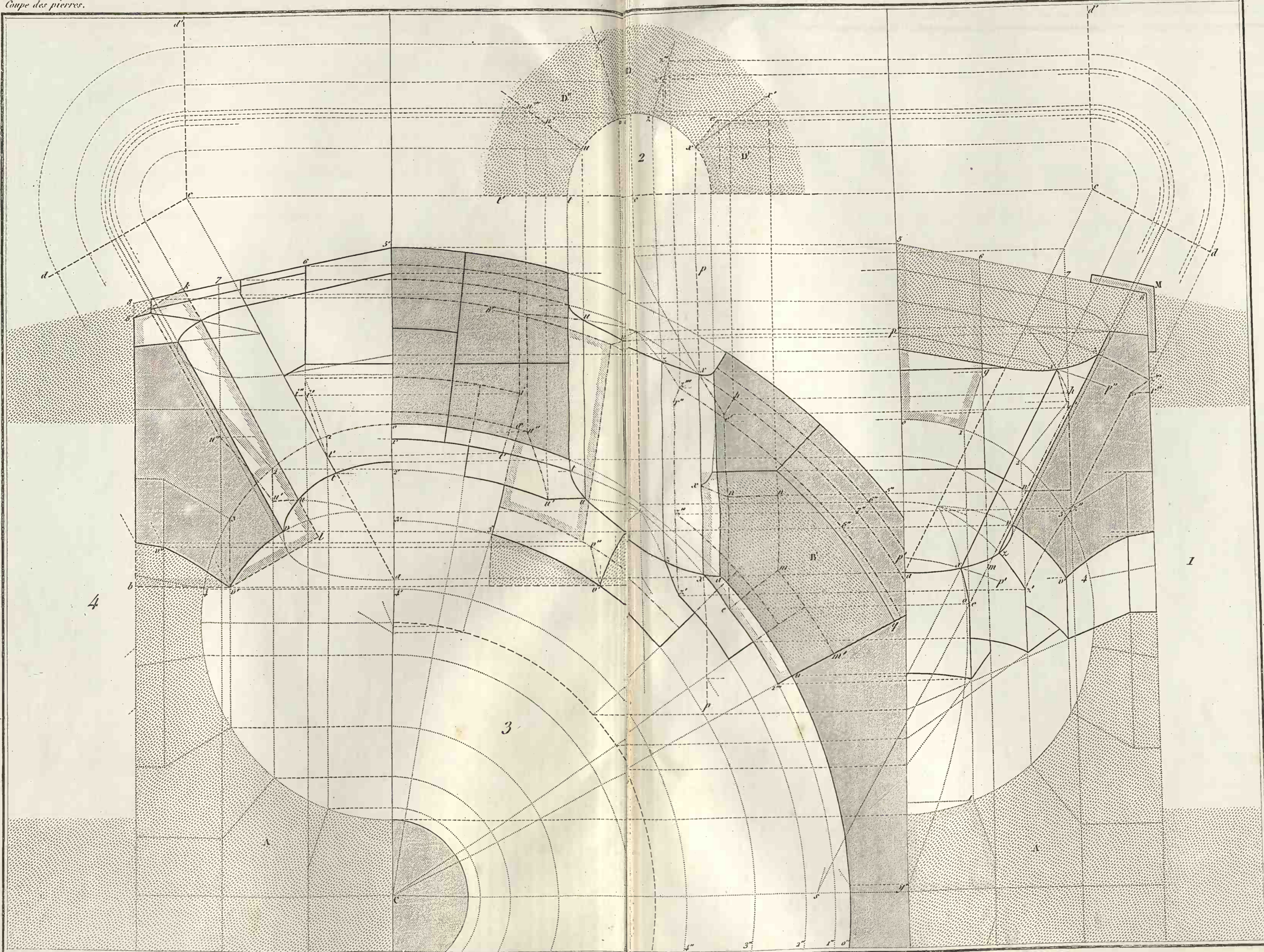
Coupe des pierres.

Pl. 43.

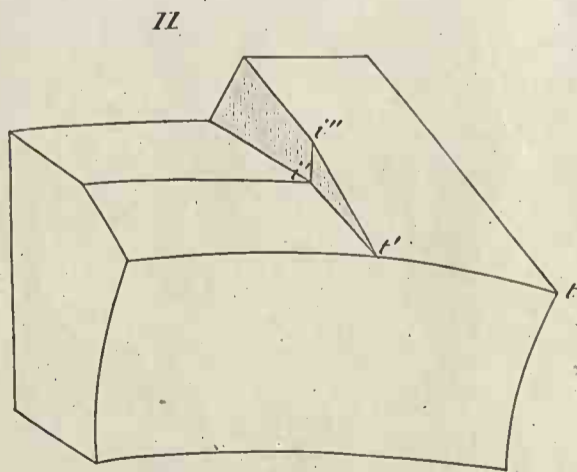
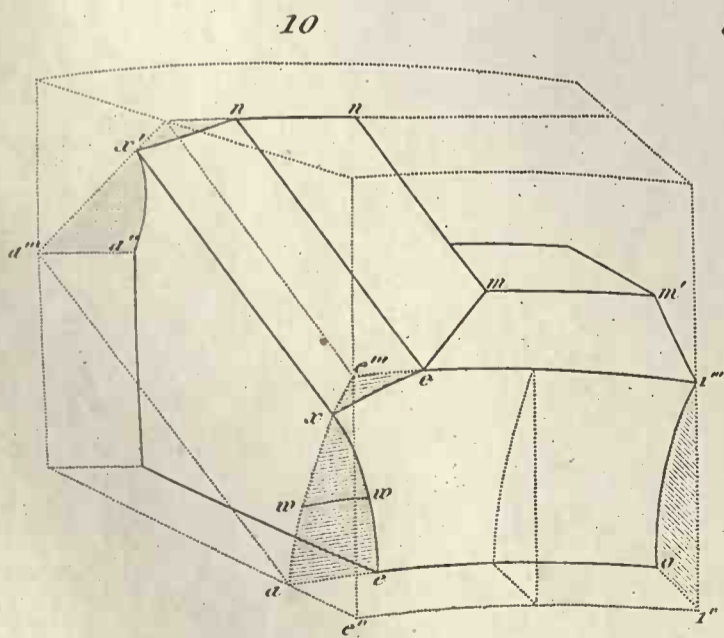
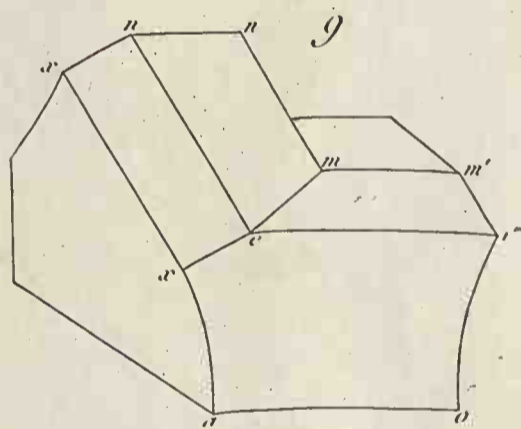
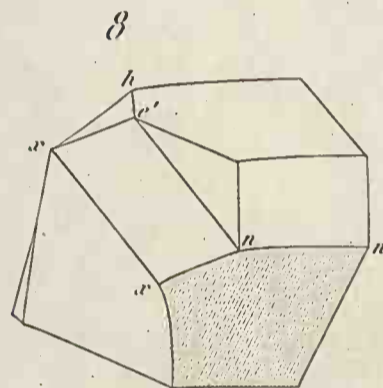
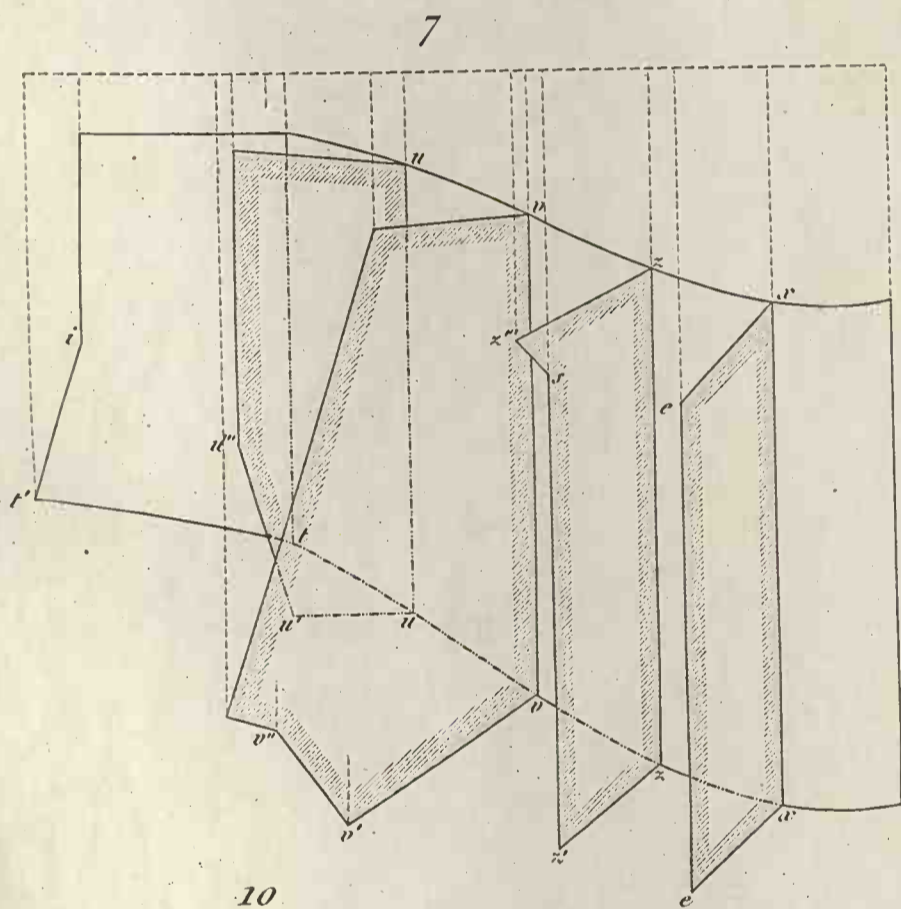
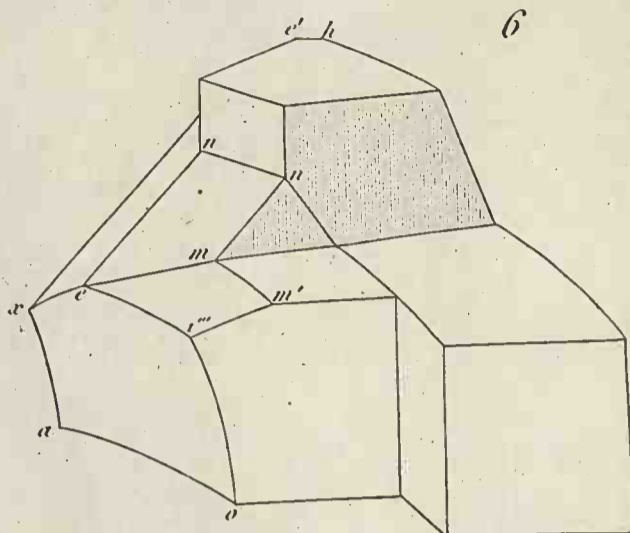
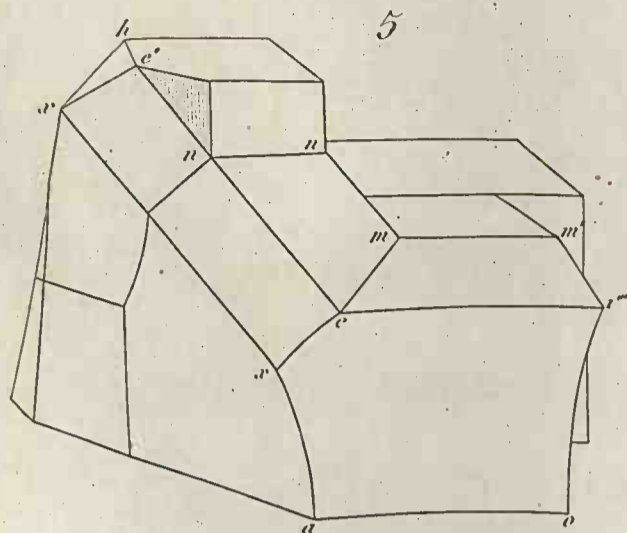


Coupe des pierres.



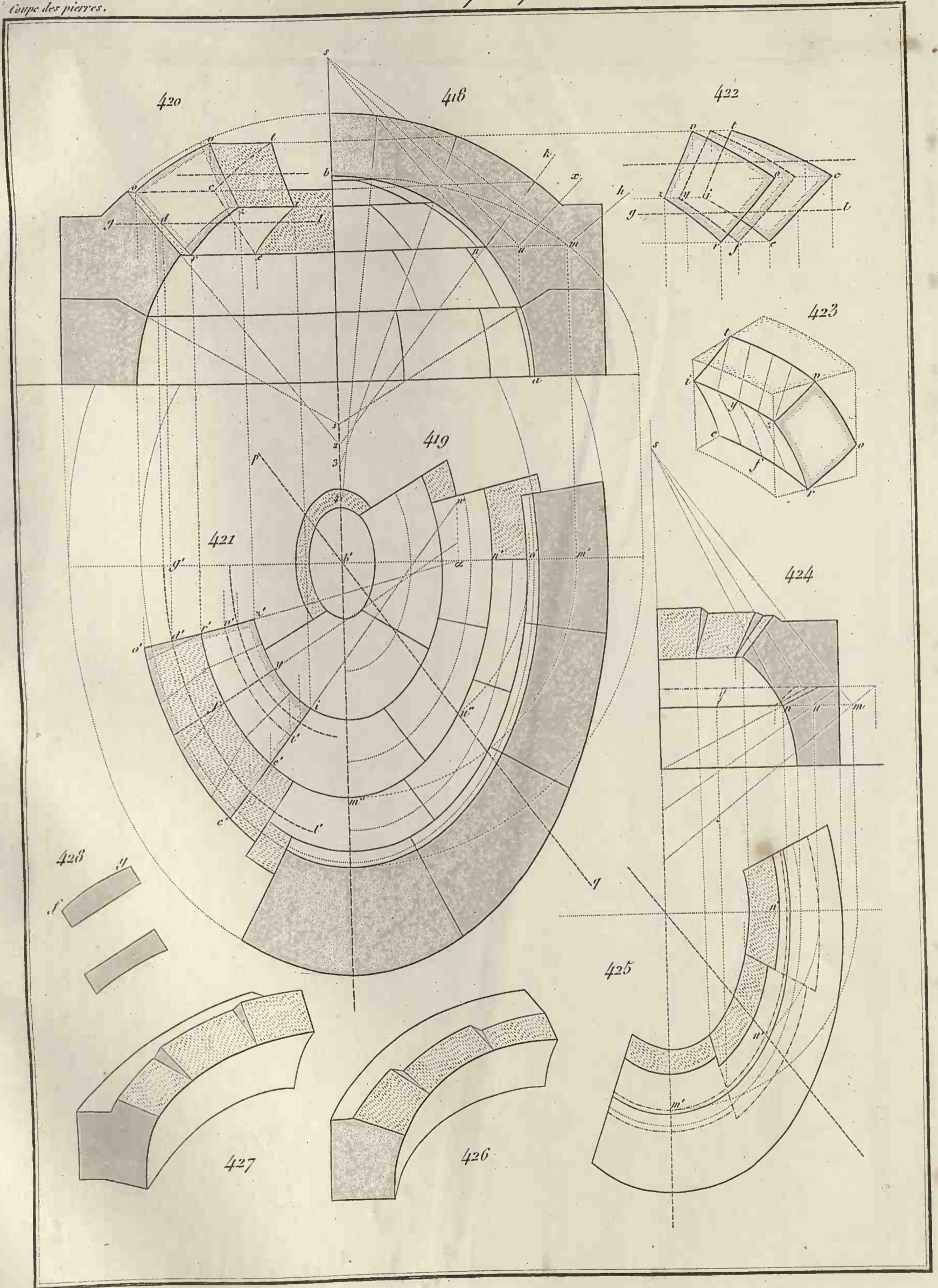


Coupe des pierres



Voute elliptique.

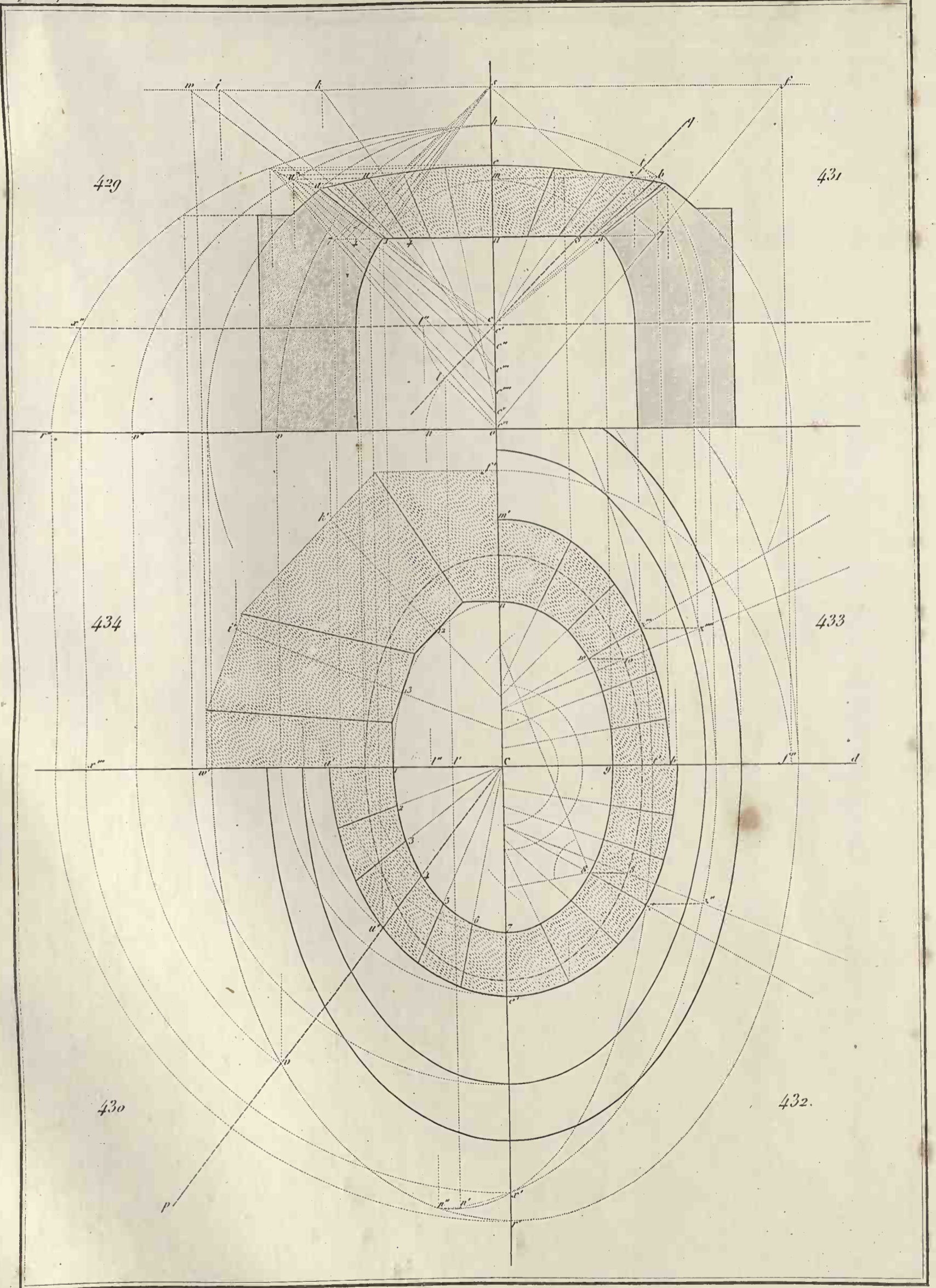
Coupe des pierres.



Jointz de la Voute elliptique.

Coupe des pierres.

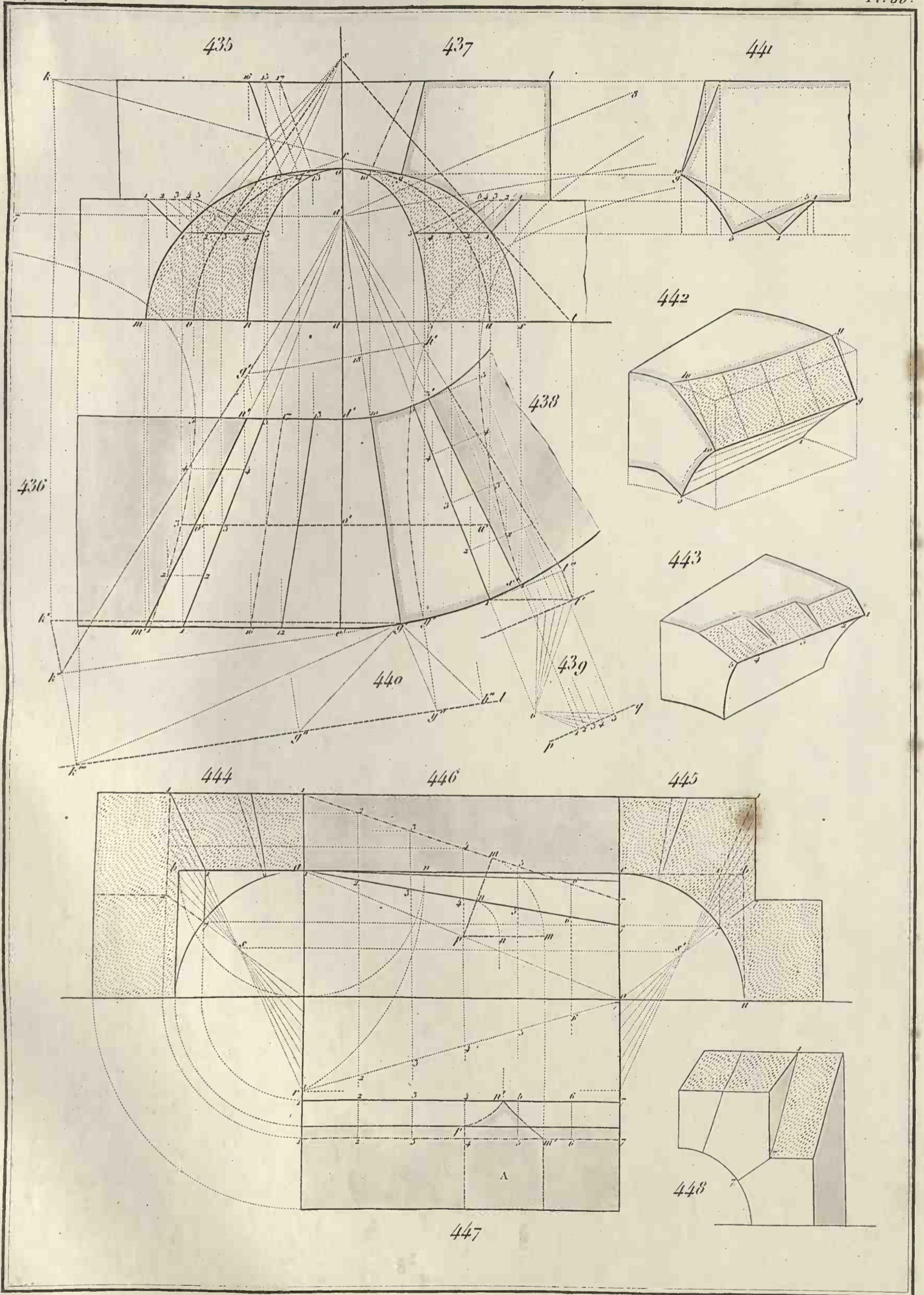
Pl. 49.



Conoides.

Coupe des pierres.

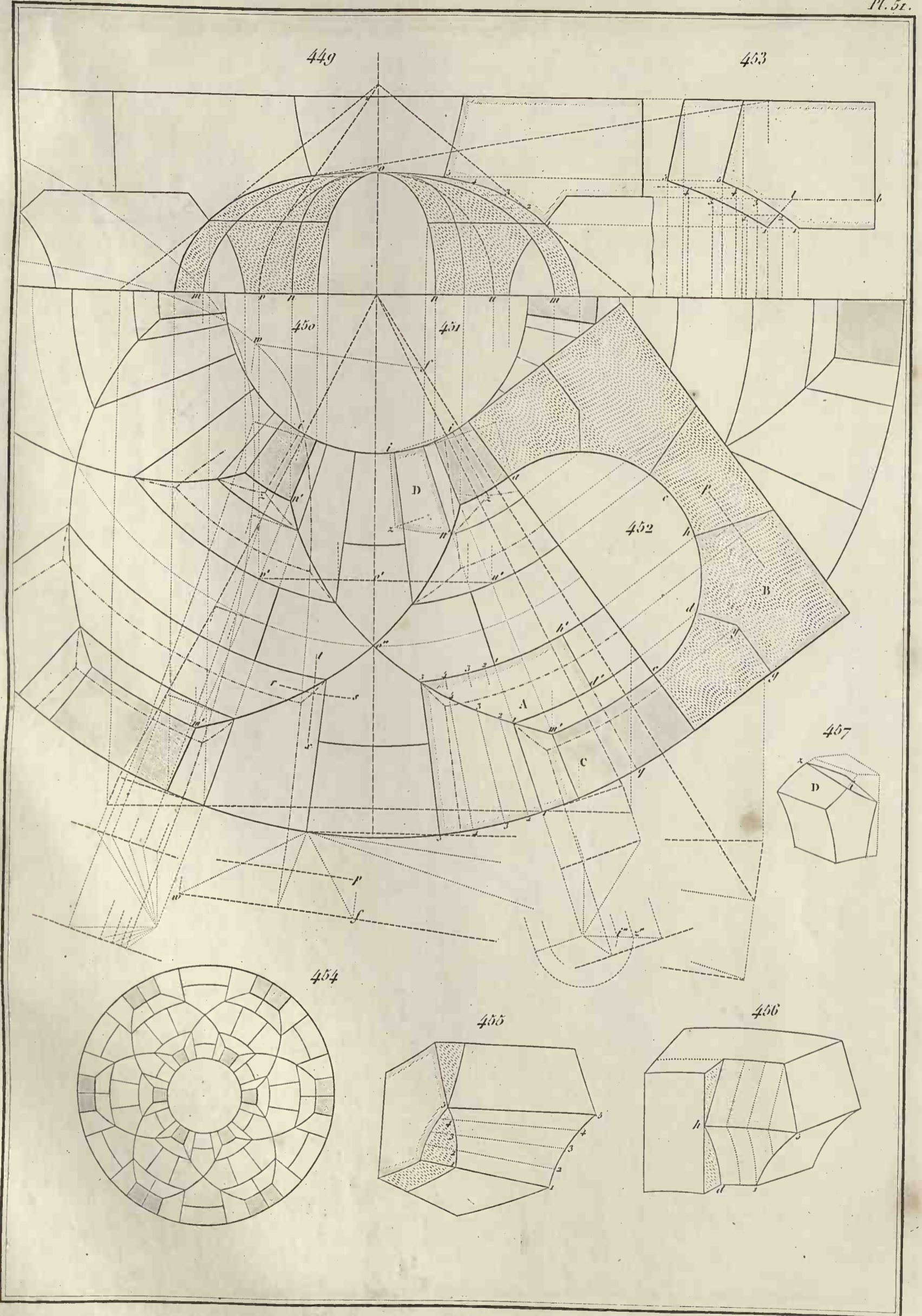
Pl. 50.



Voute d'arcete annulaire.

Coupe des pierres.

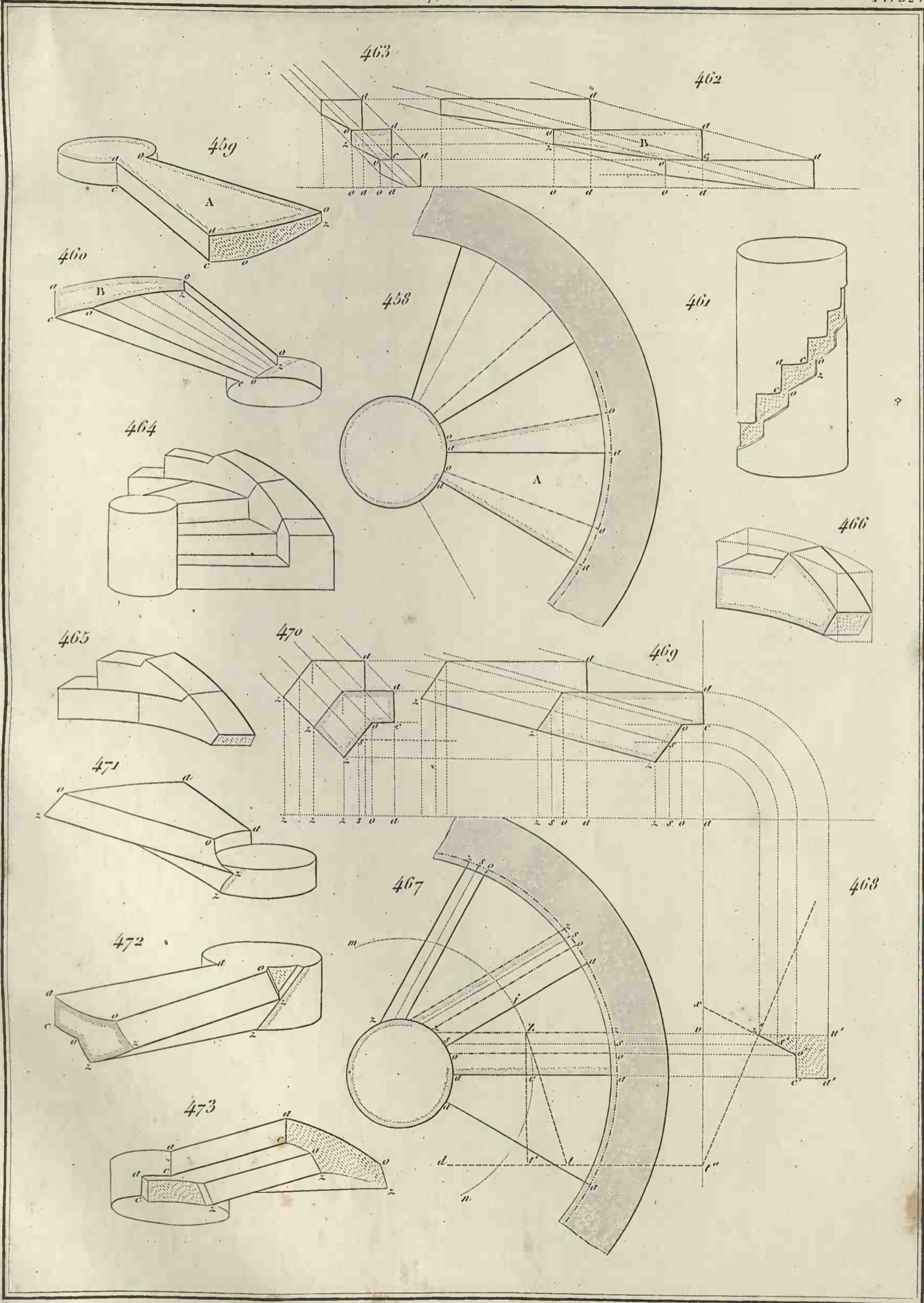
Pl. 51.



Vis à noyau plein.

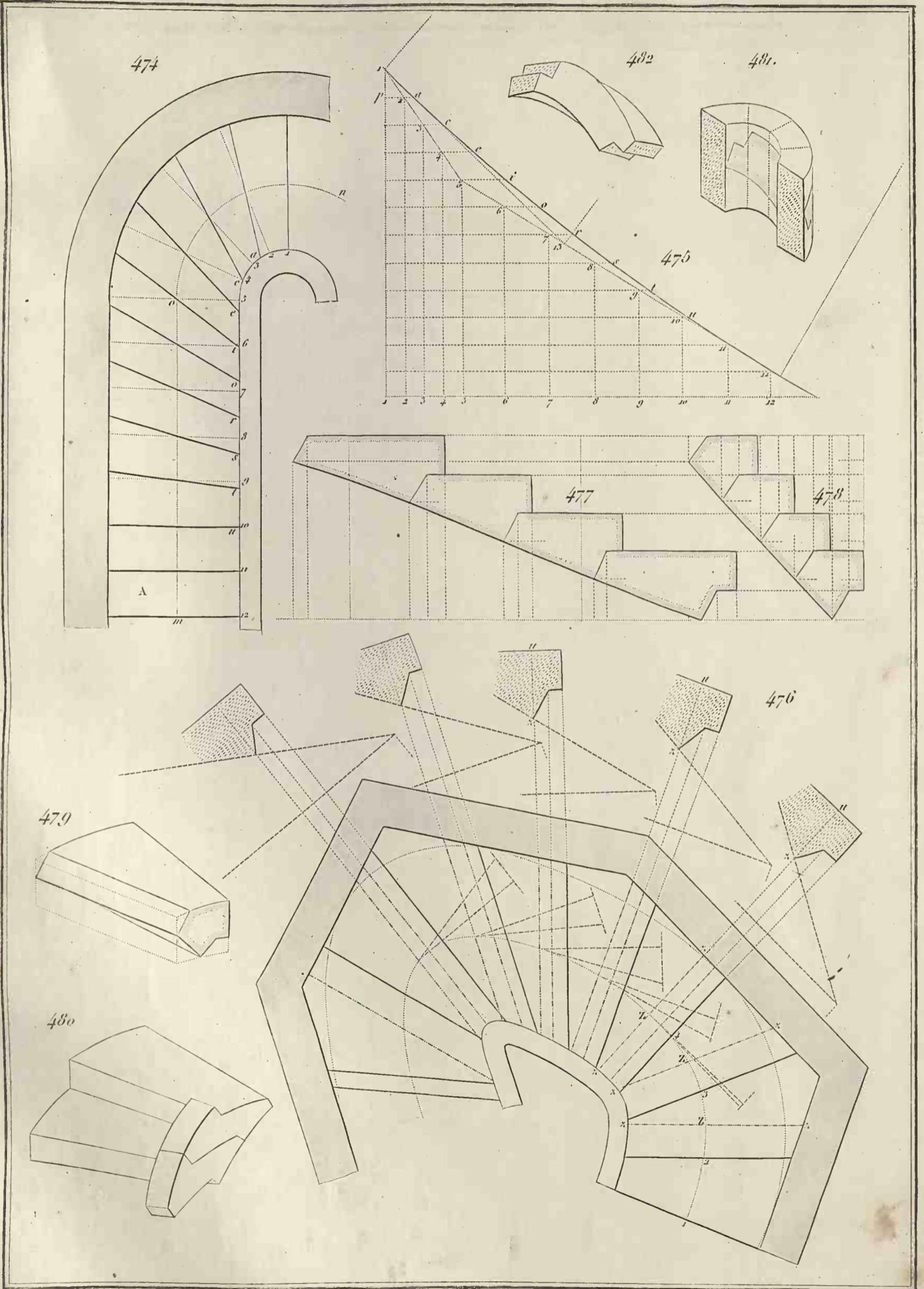
Coupe des pierres.

Pl. 52.



Balancement.

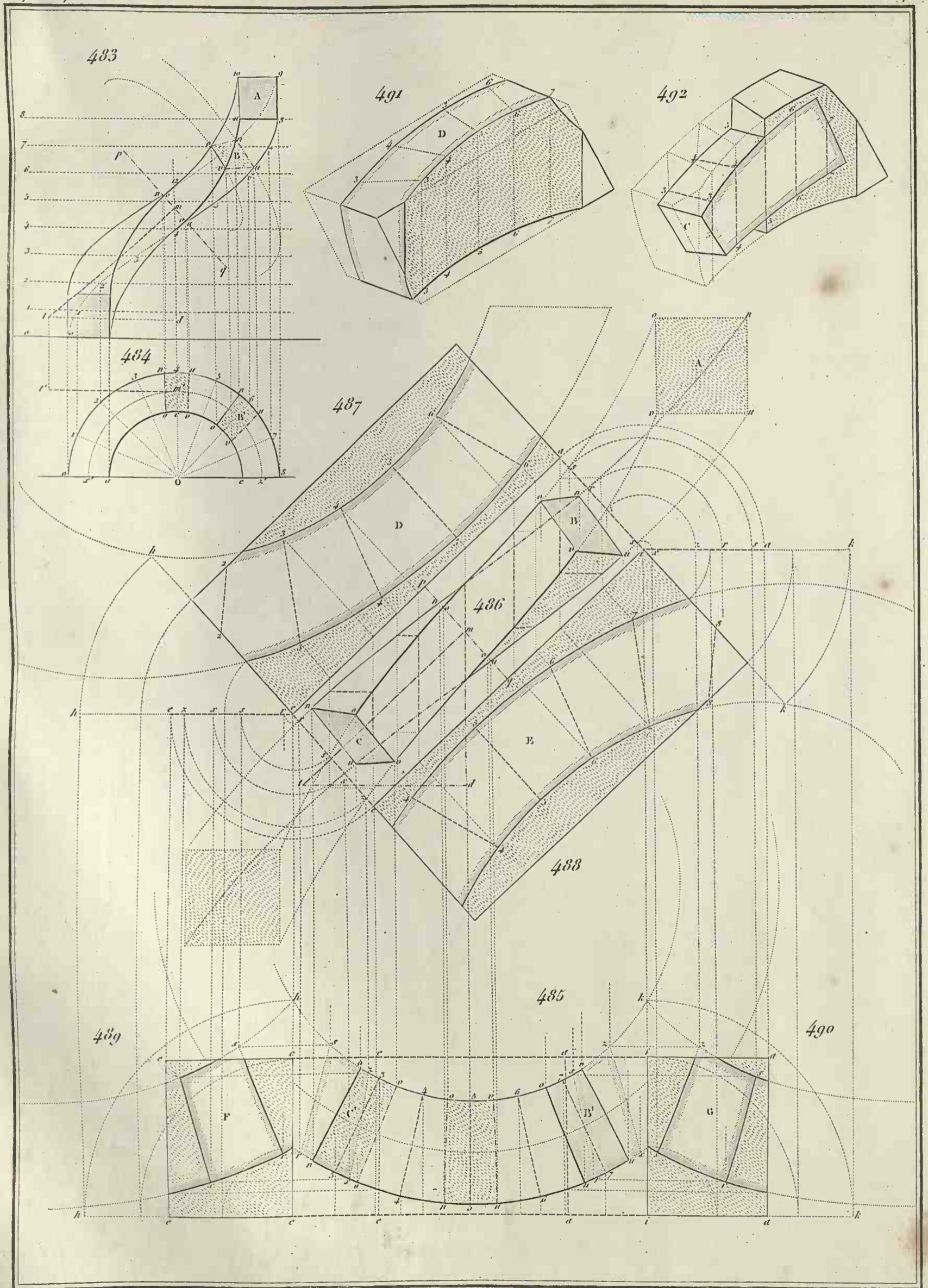
Coupe des pierres.

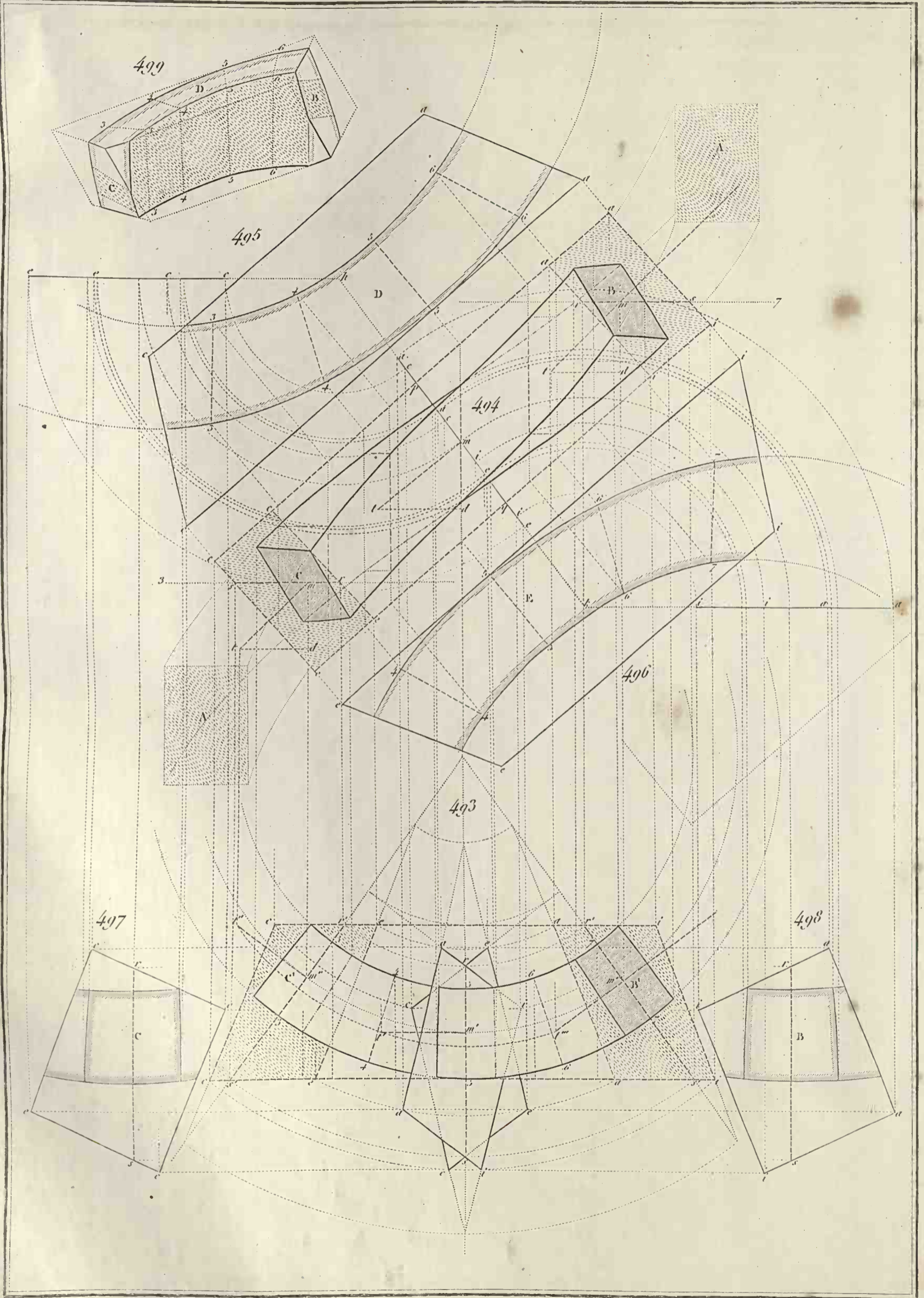


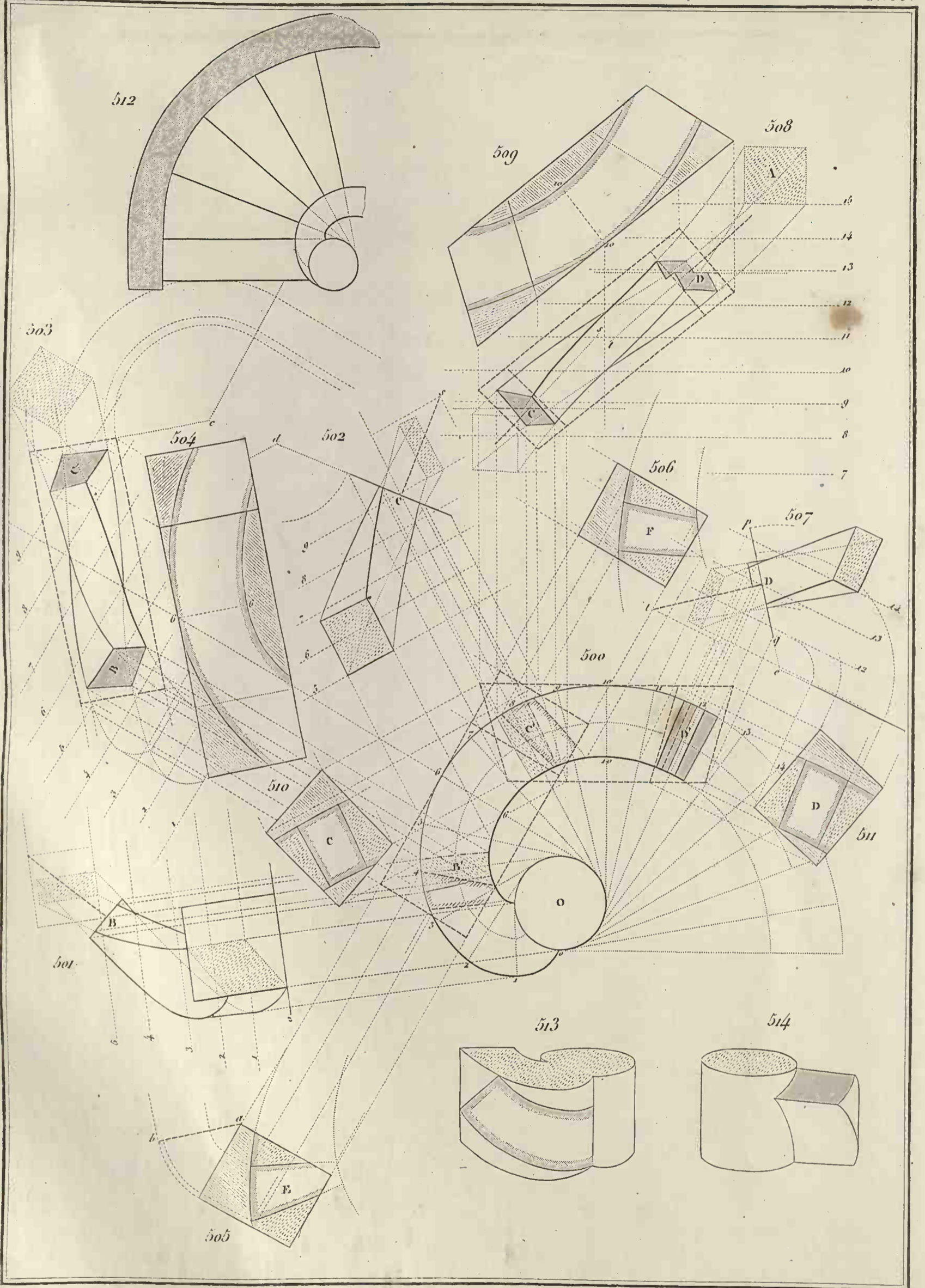
Limon.

Coupe des pierres.

Pl. 54.



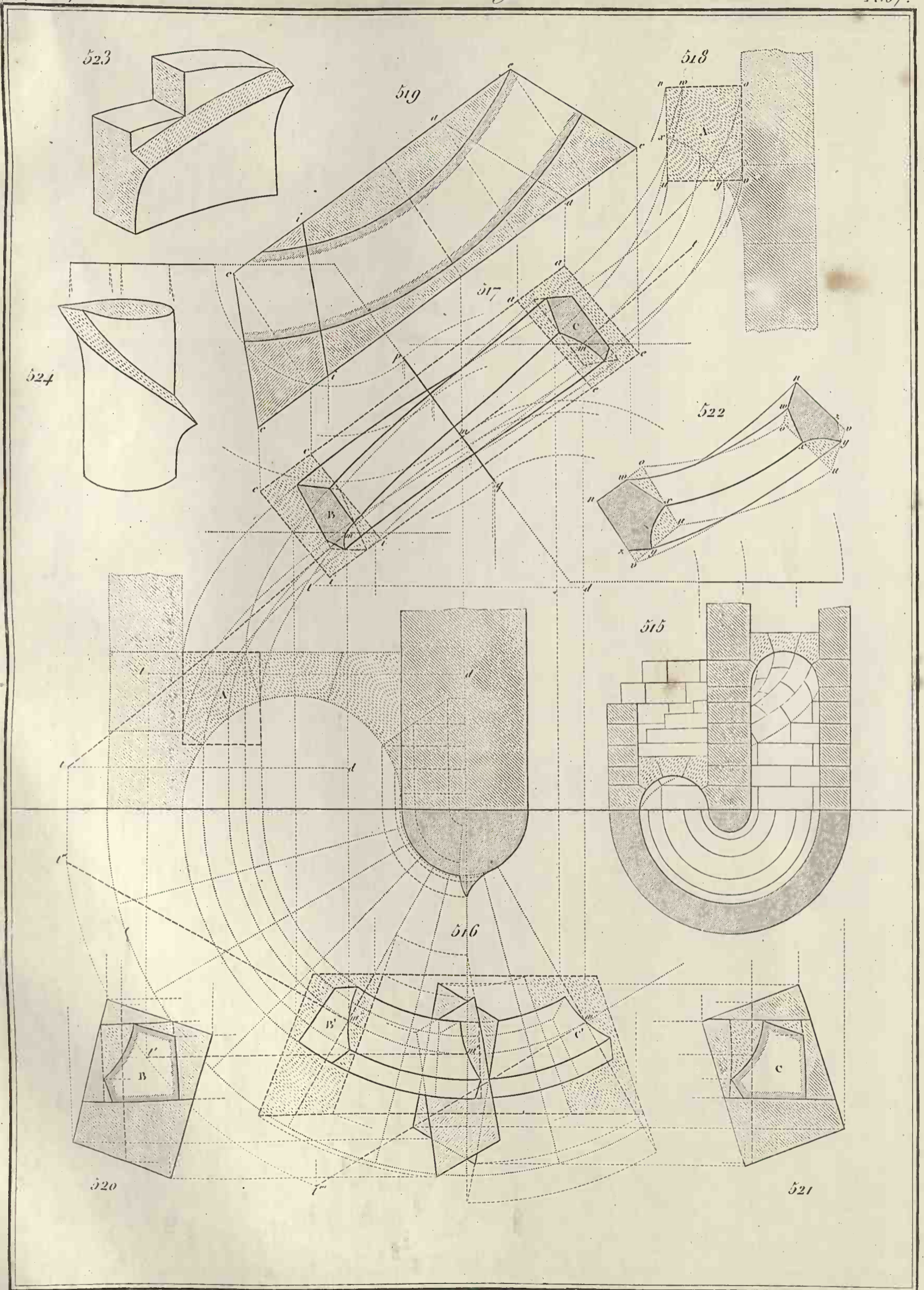


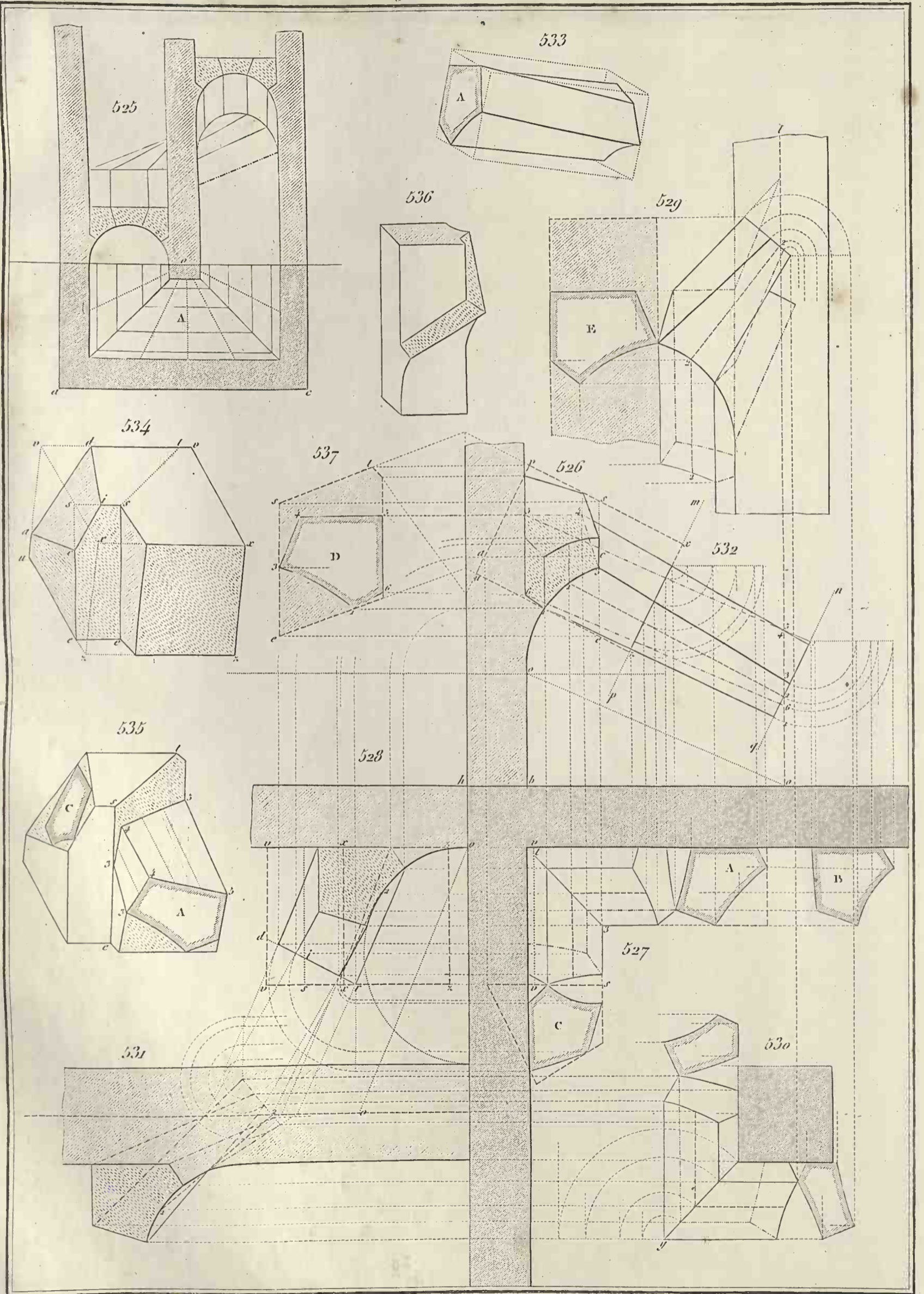


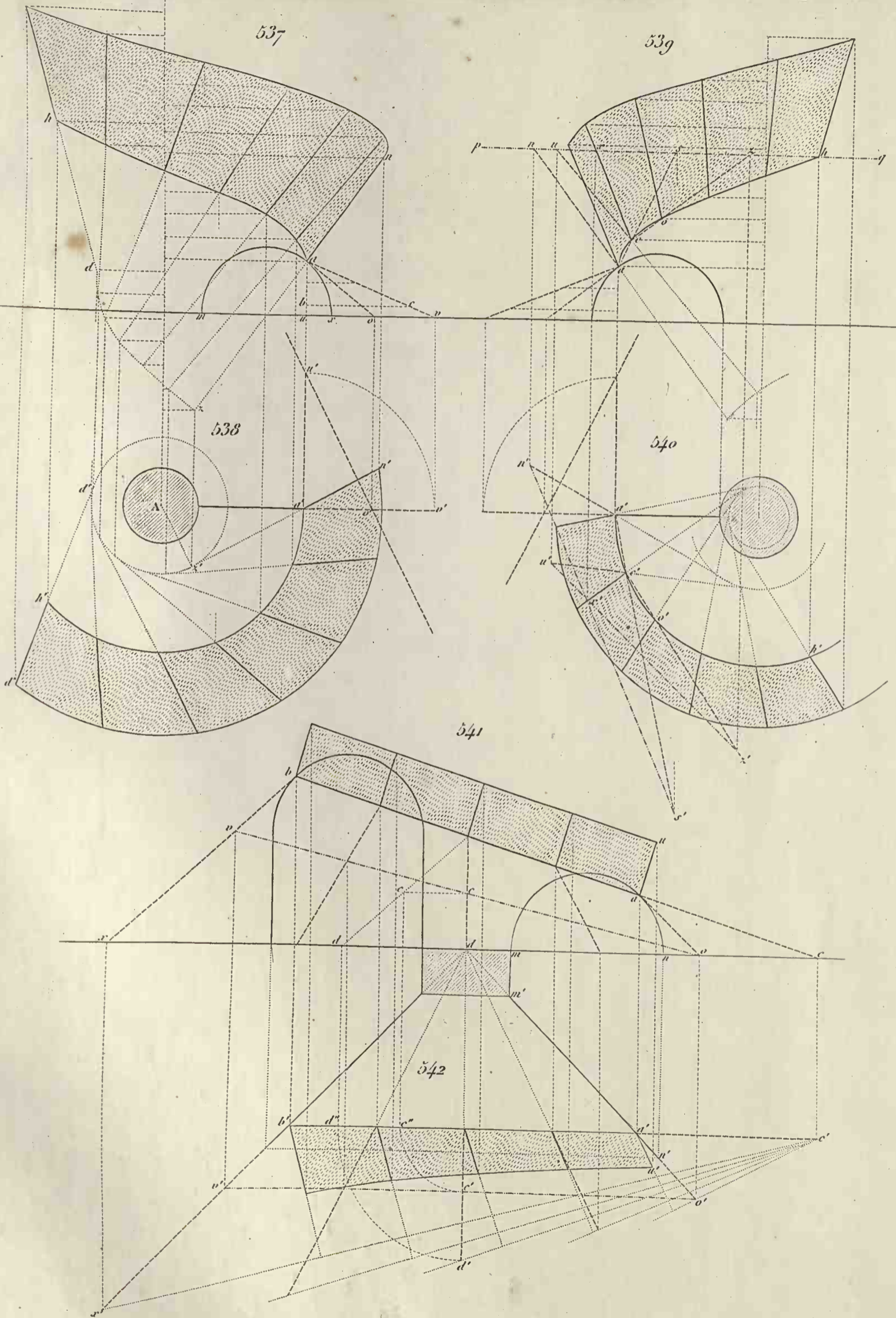
Vis Saint Gilles.

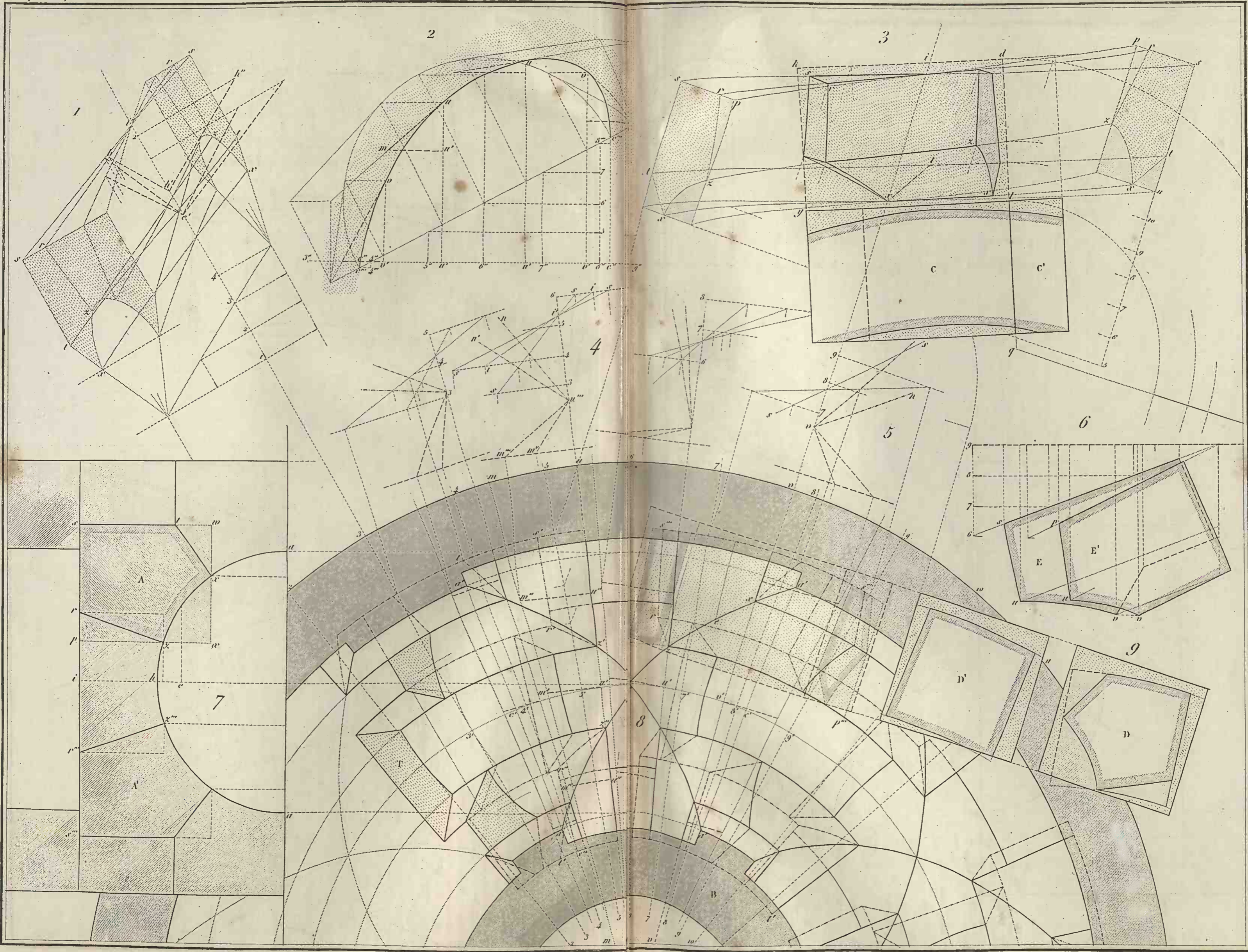
Coupe des pierres.

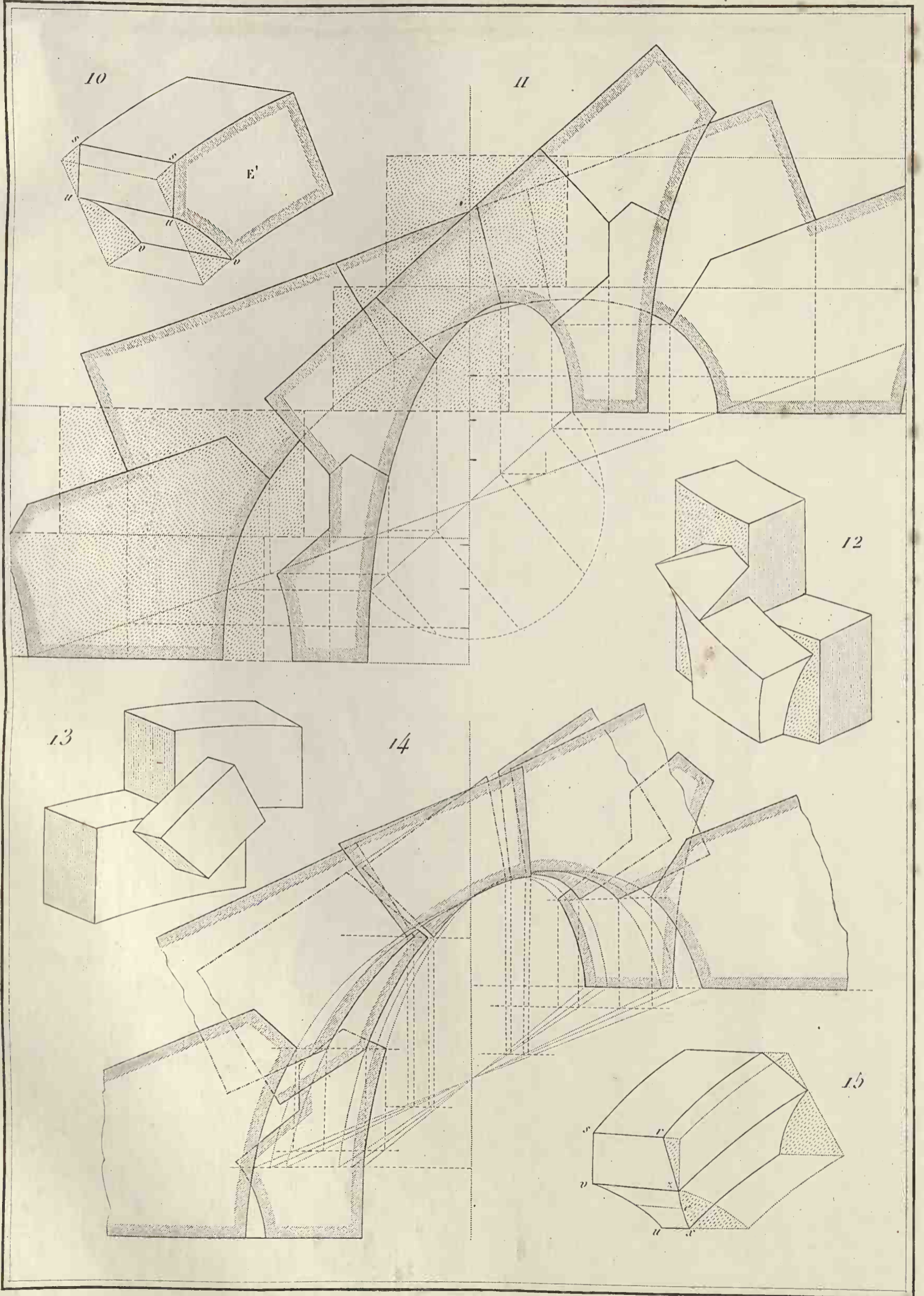
Pl. 57.



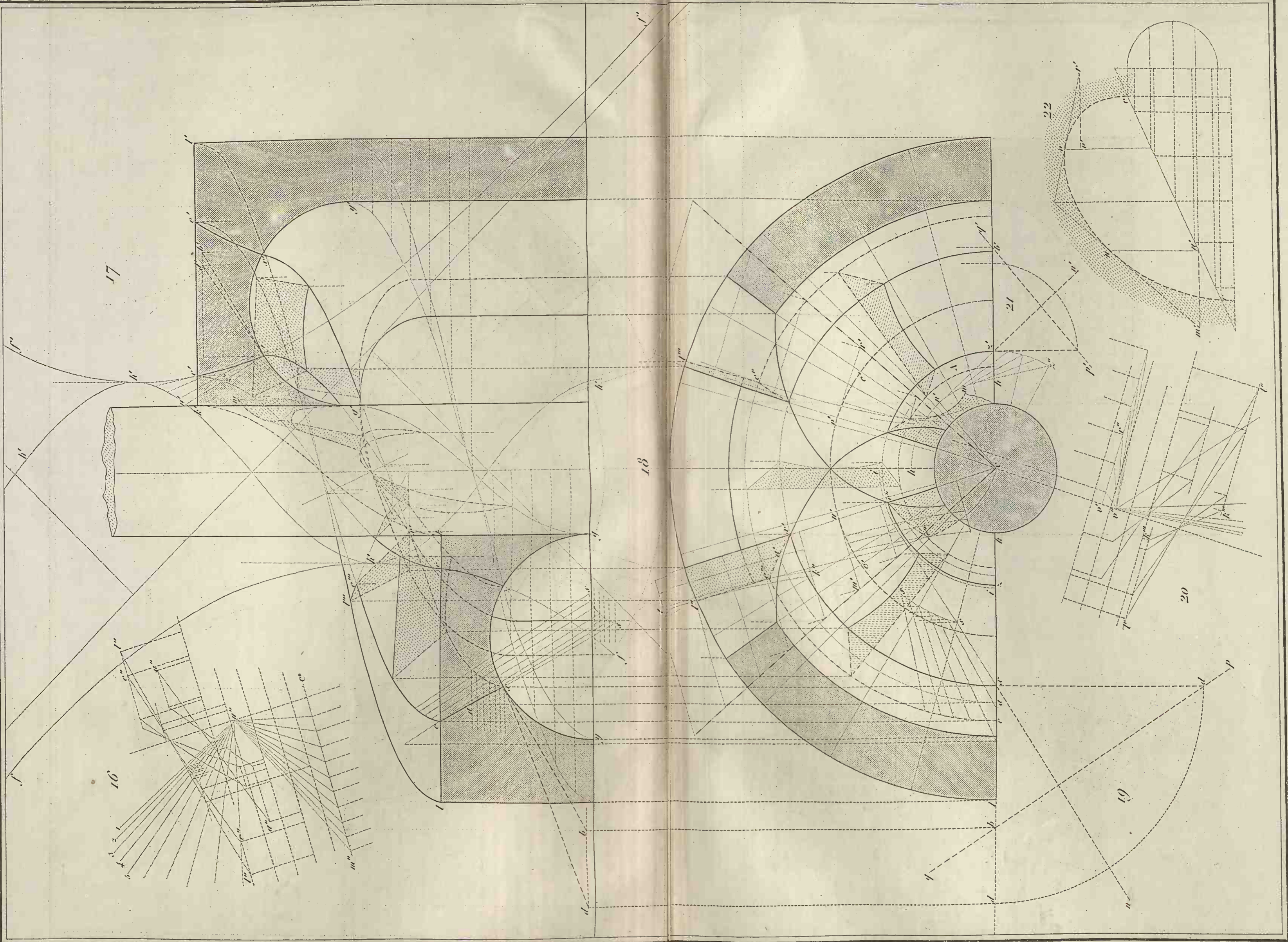








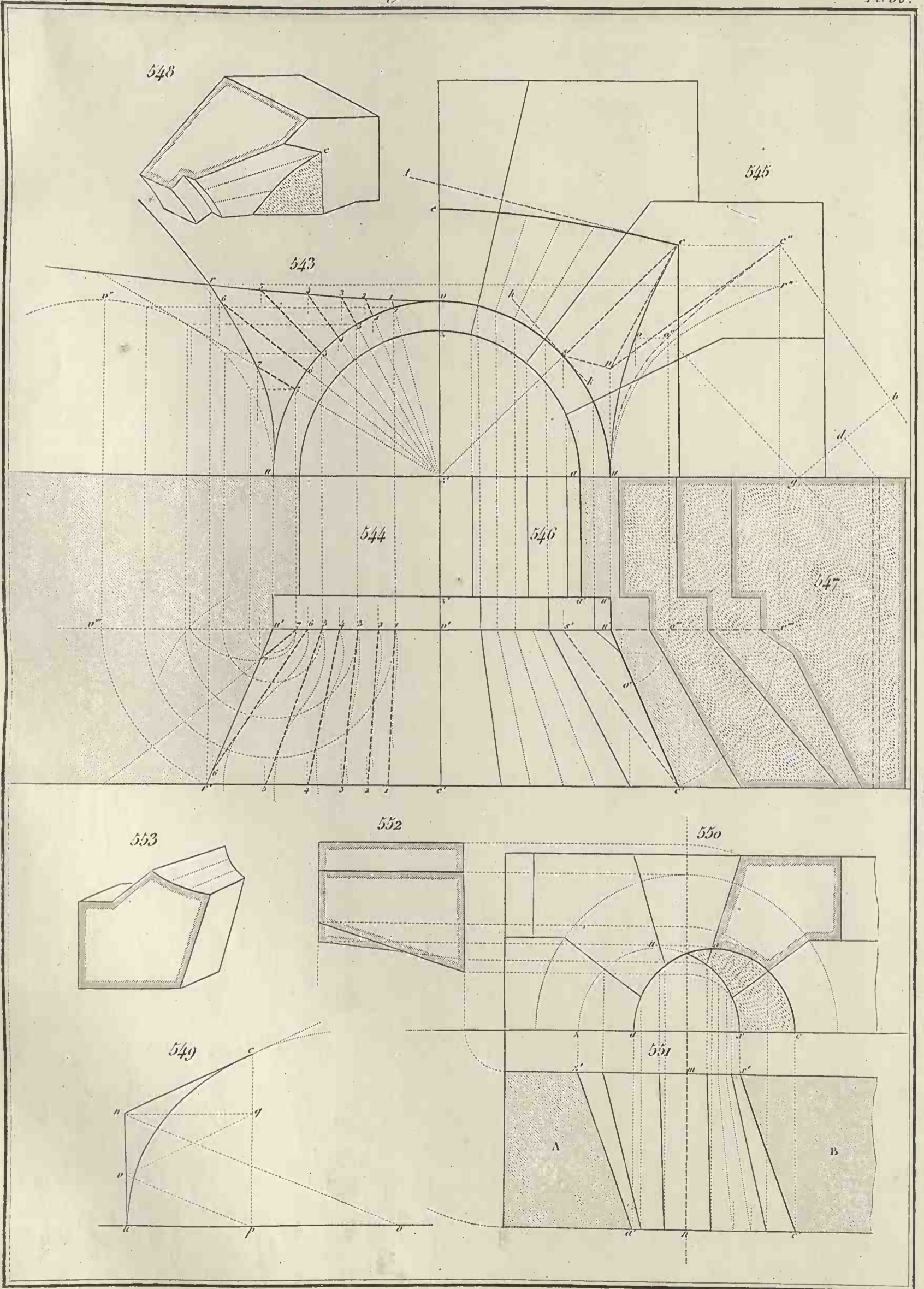
Voûte d'arête rampante et en tour ronde.



Arrière Voute de Marseille.

Coupe des pierres.

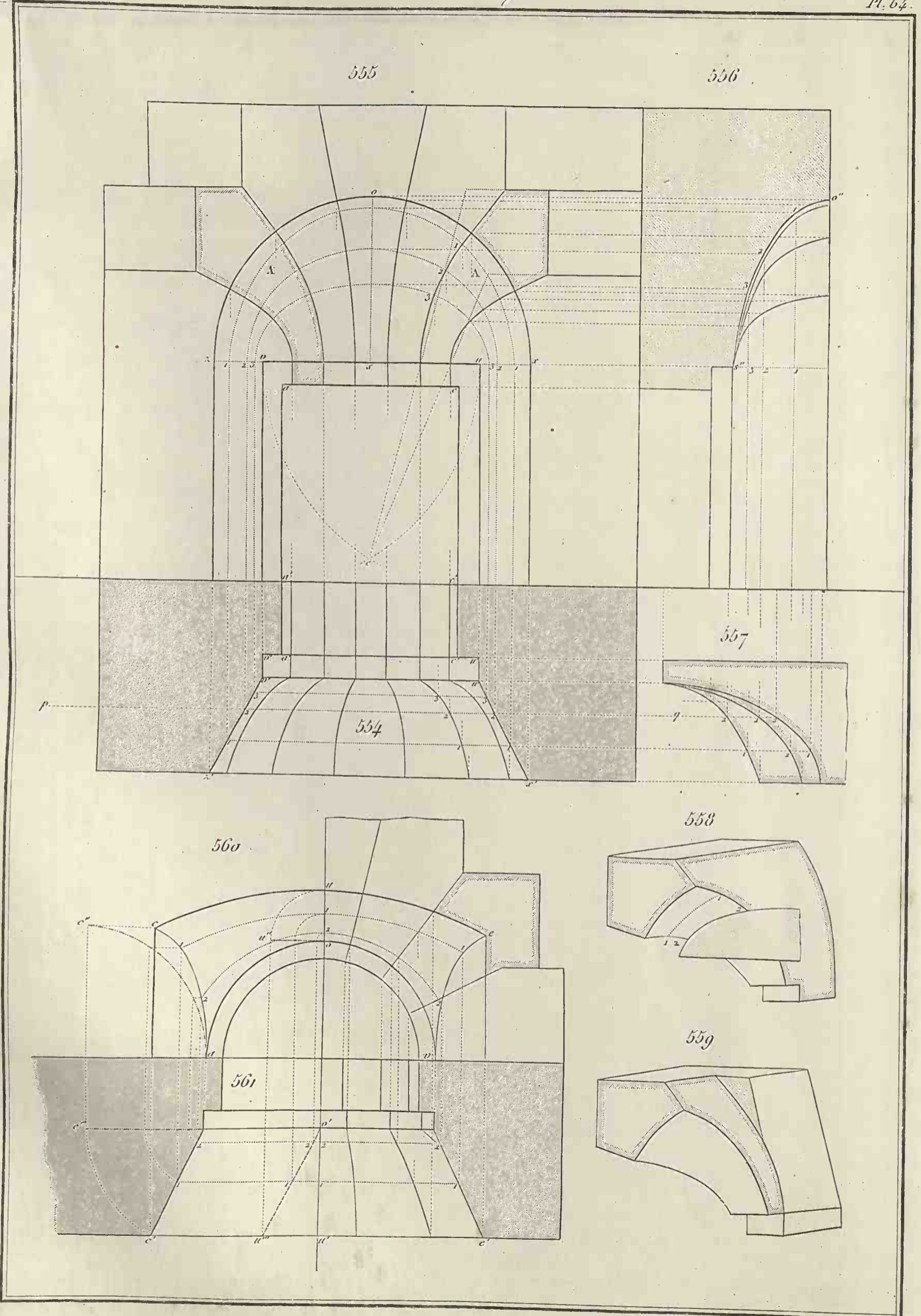
Pl. 63.



Arrières-Voussures.

Coupe des pierres.

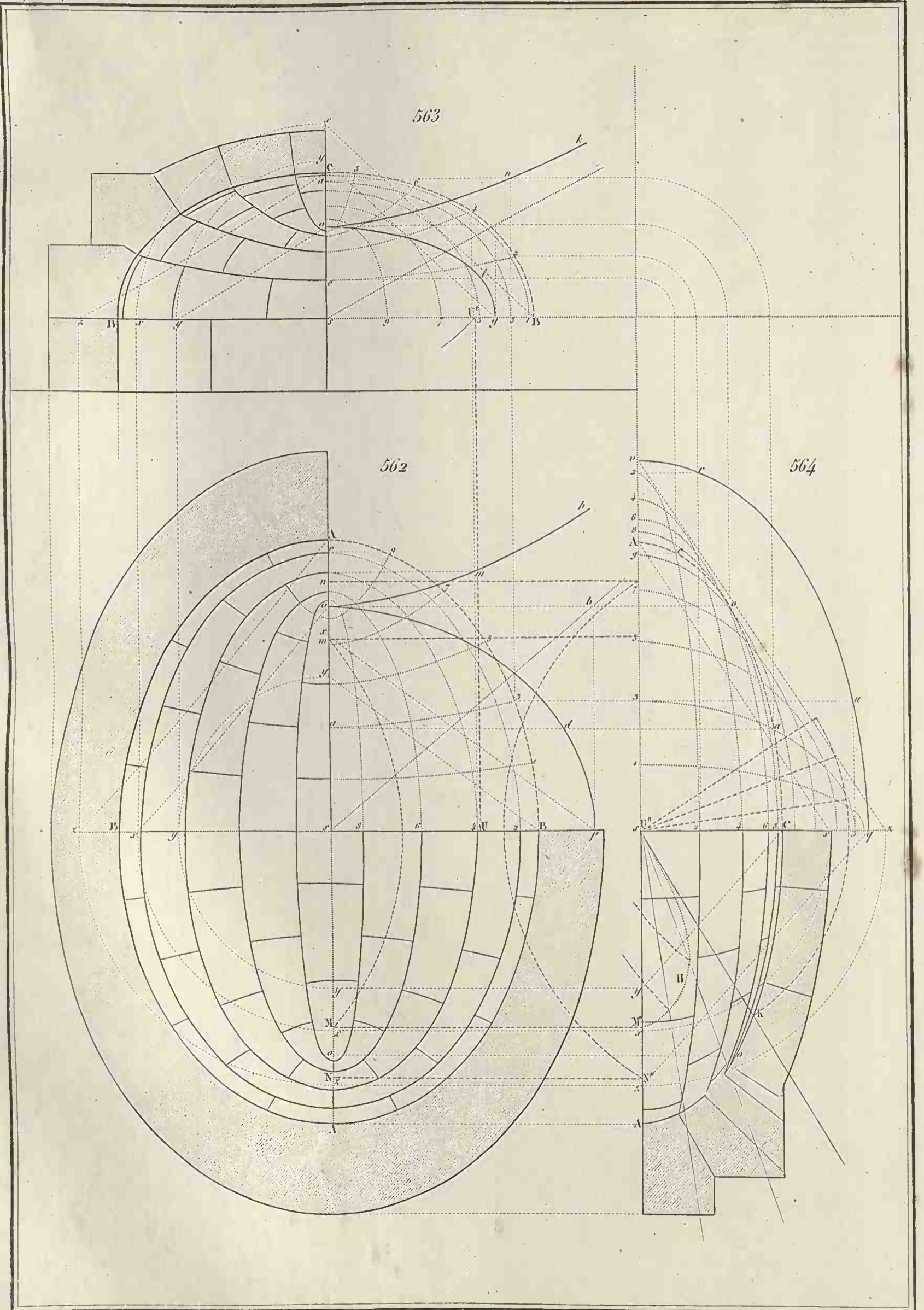
Pl. 64.



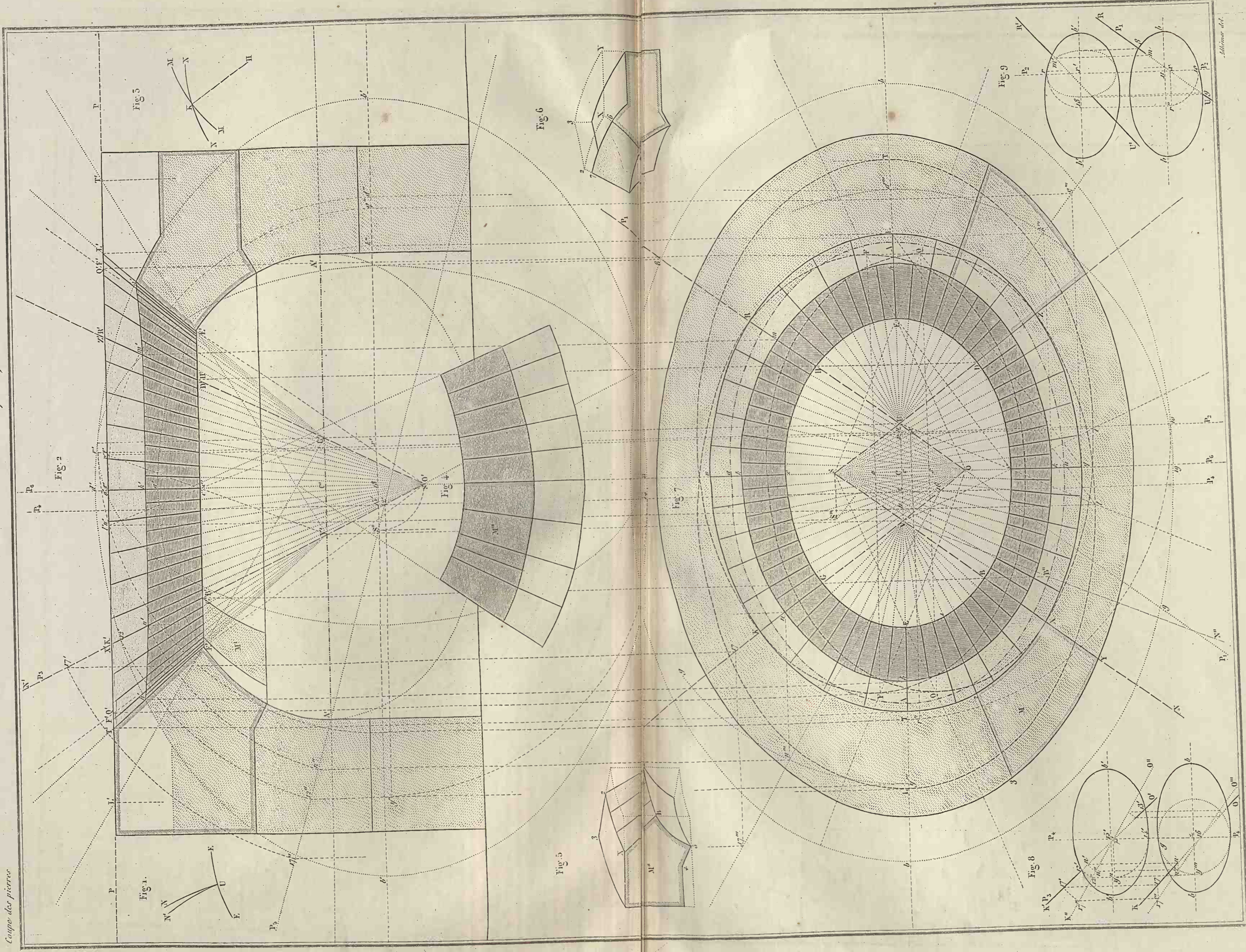
Voute elliptique à trois arcs.

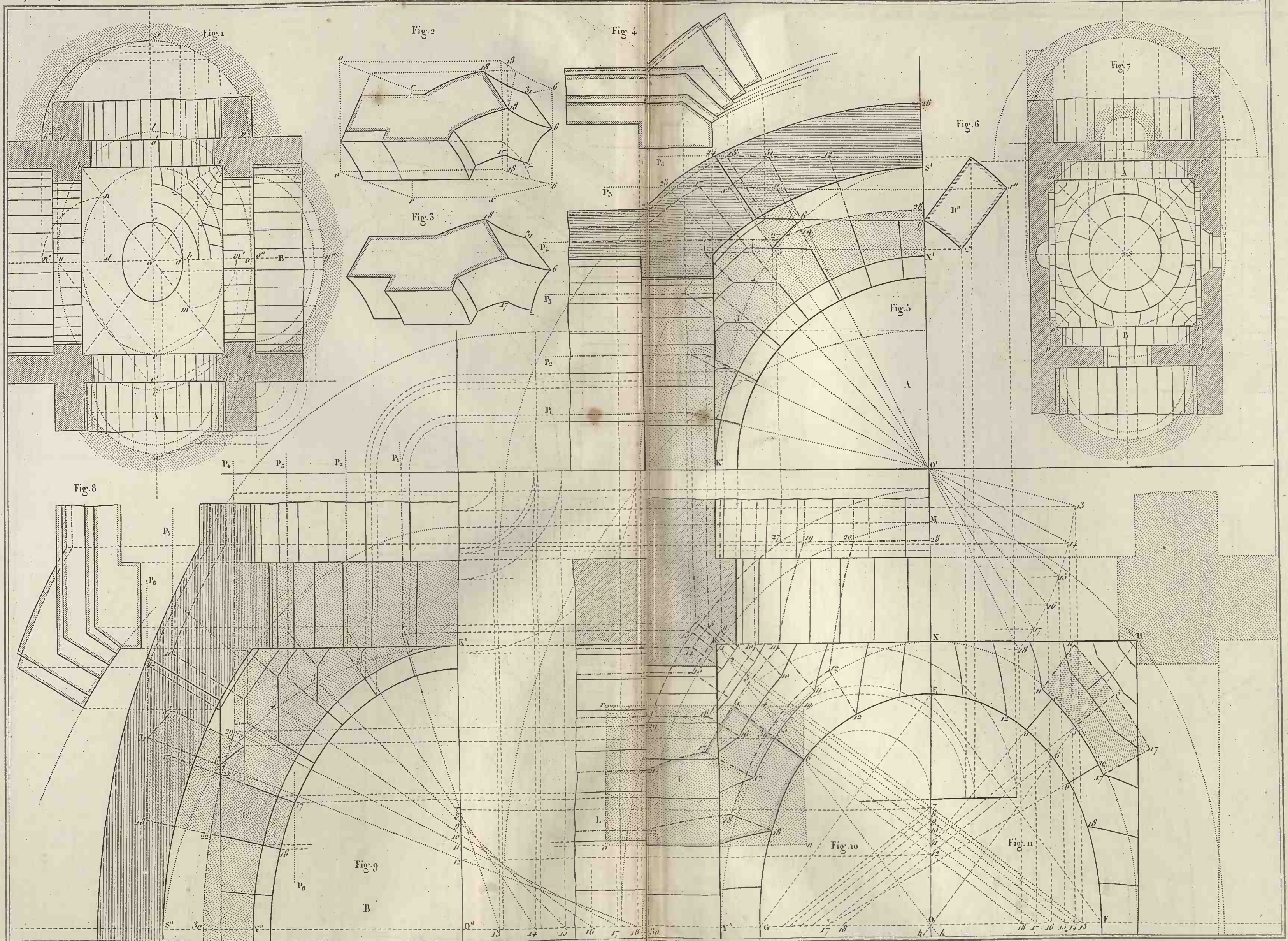
Coupe des pierres.

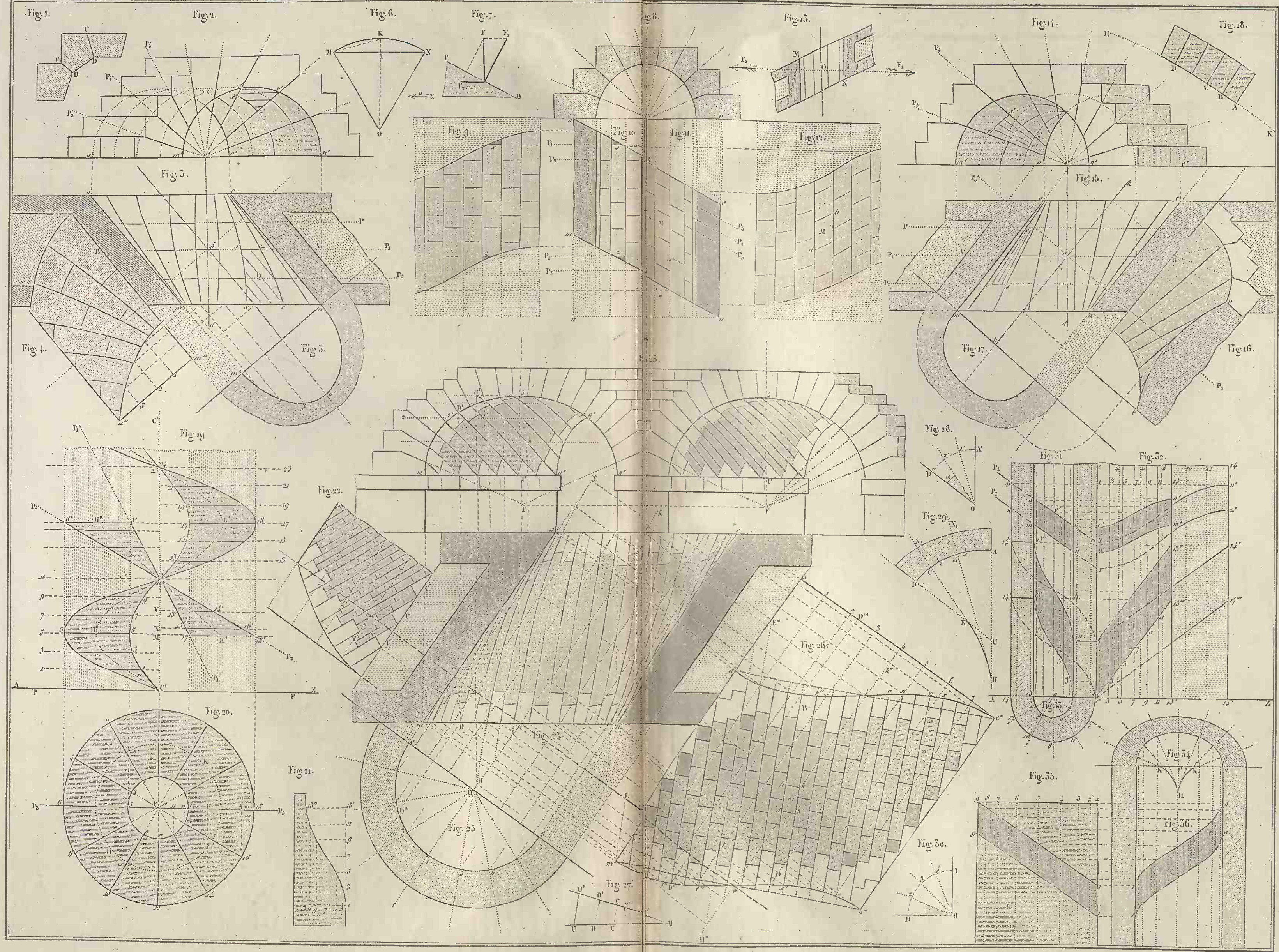
Pl. 65.



Joins de la voûte elliptique







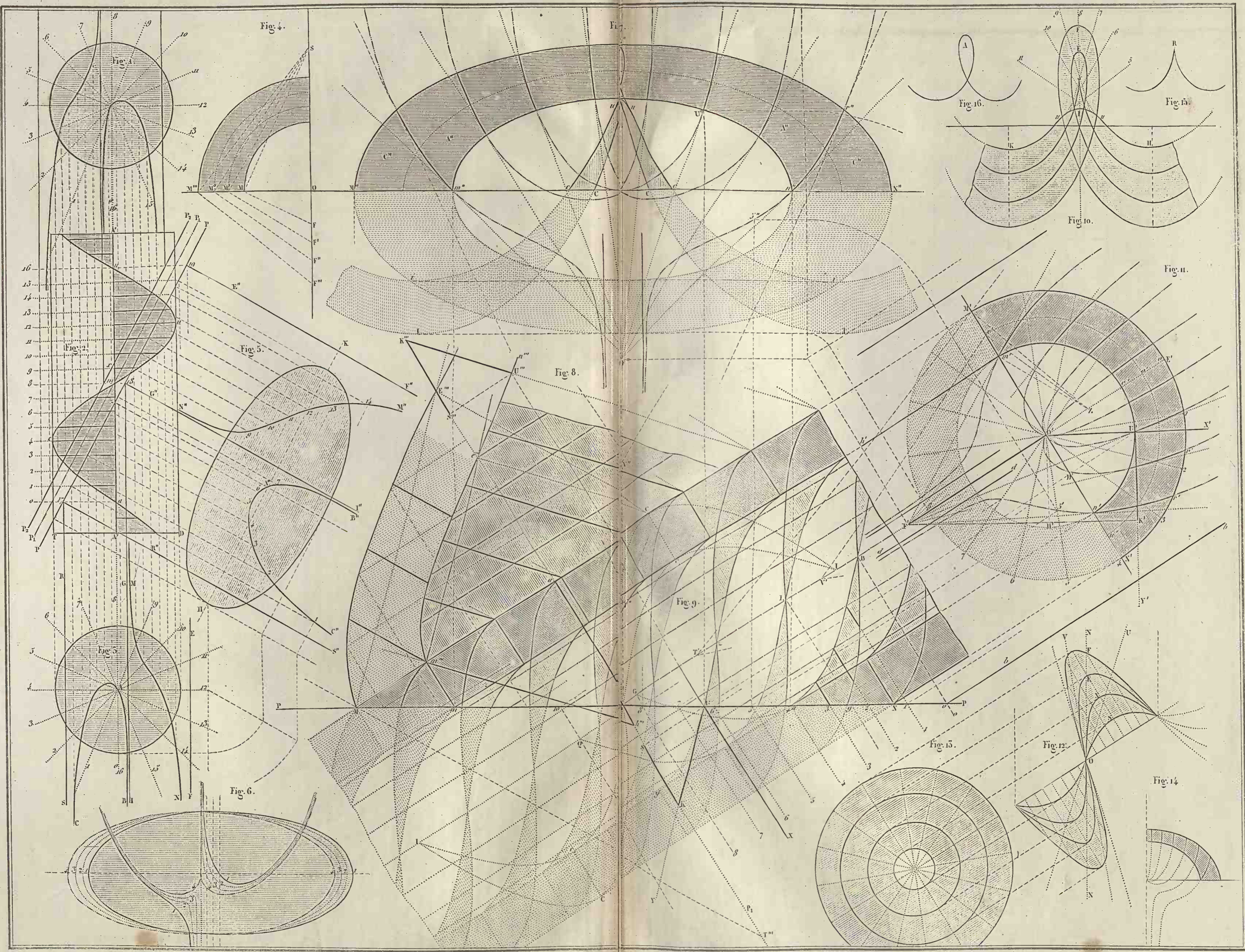


Fig. 1.

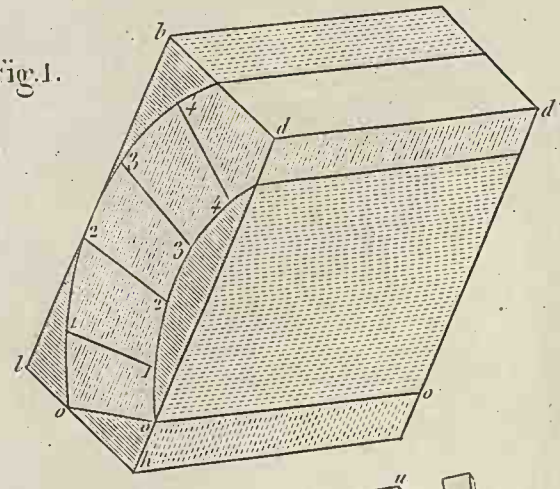


Fig. 2.

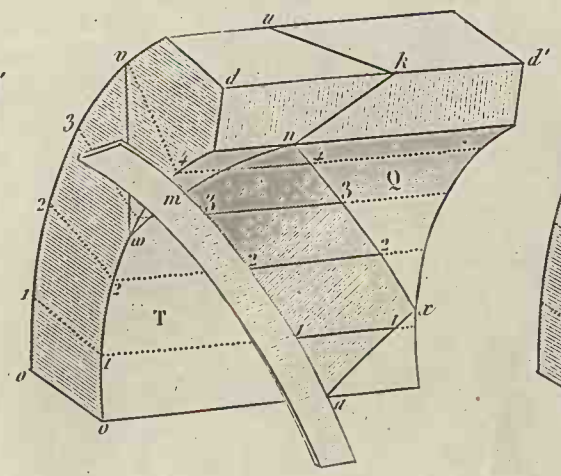


Fig. 3.

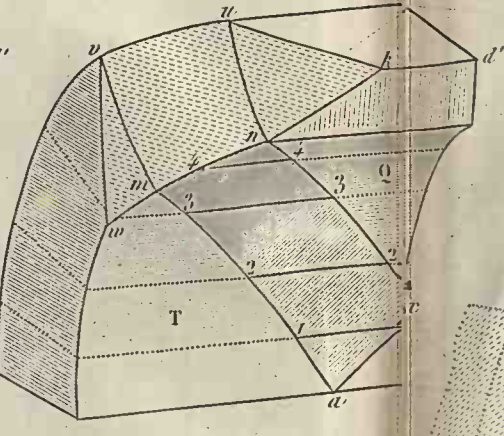


Fig. 11.

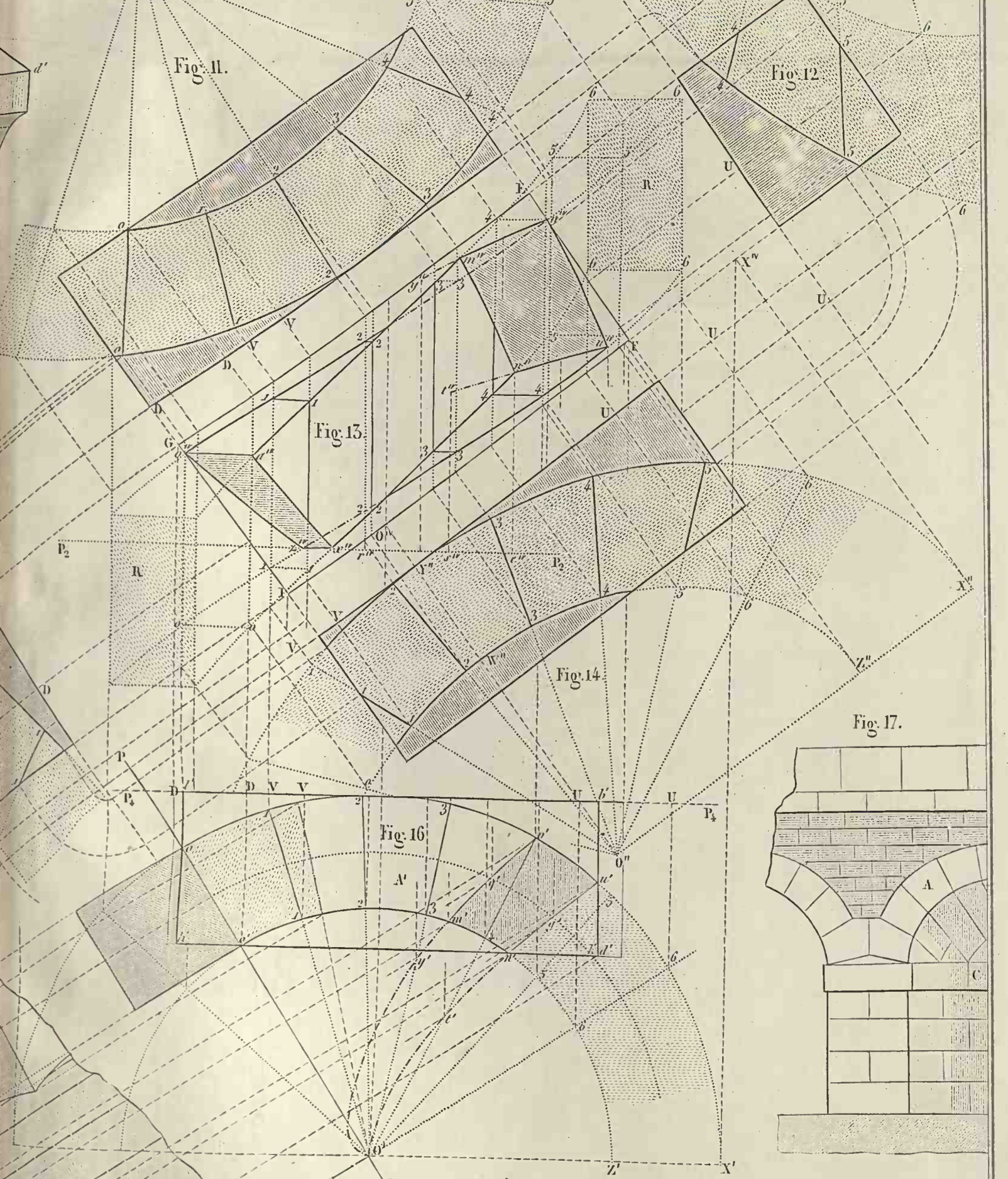


Fig. 12.



Fig. 5.

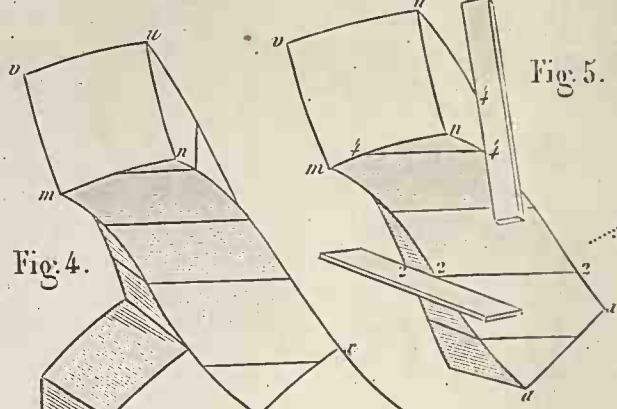


Fig. 6.

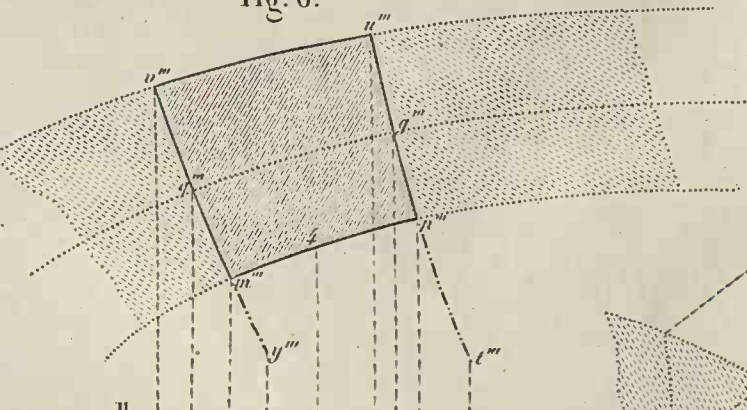


Fig. 4.

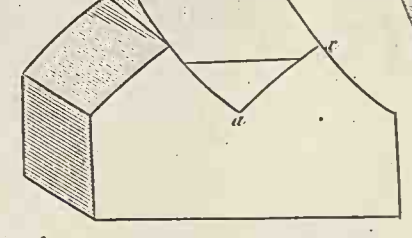


Fig. 7.

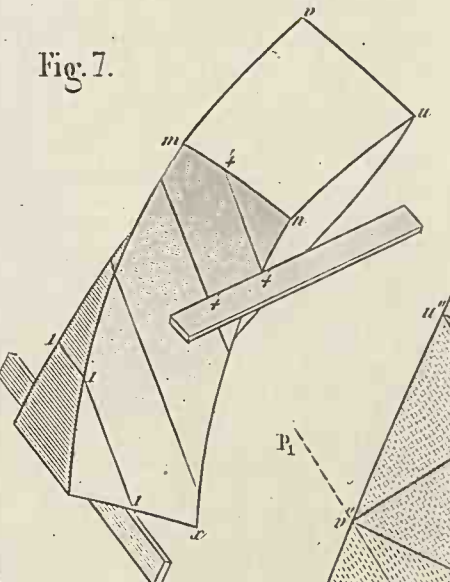


Fig. 8.

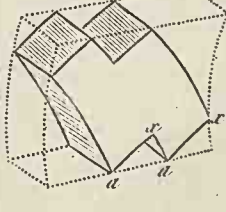


Fig. 9.

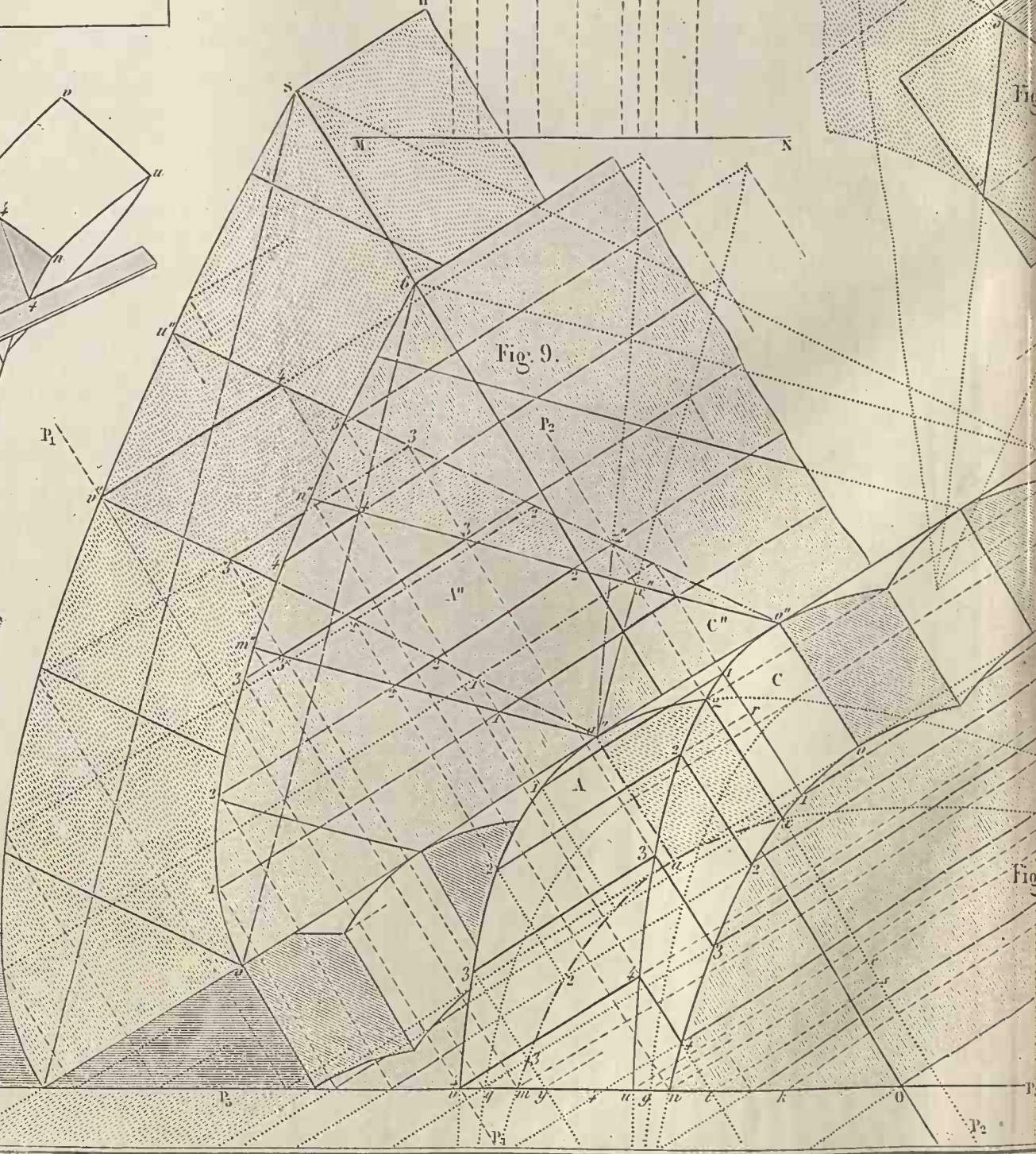


Fig. 13.

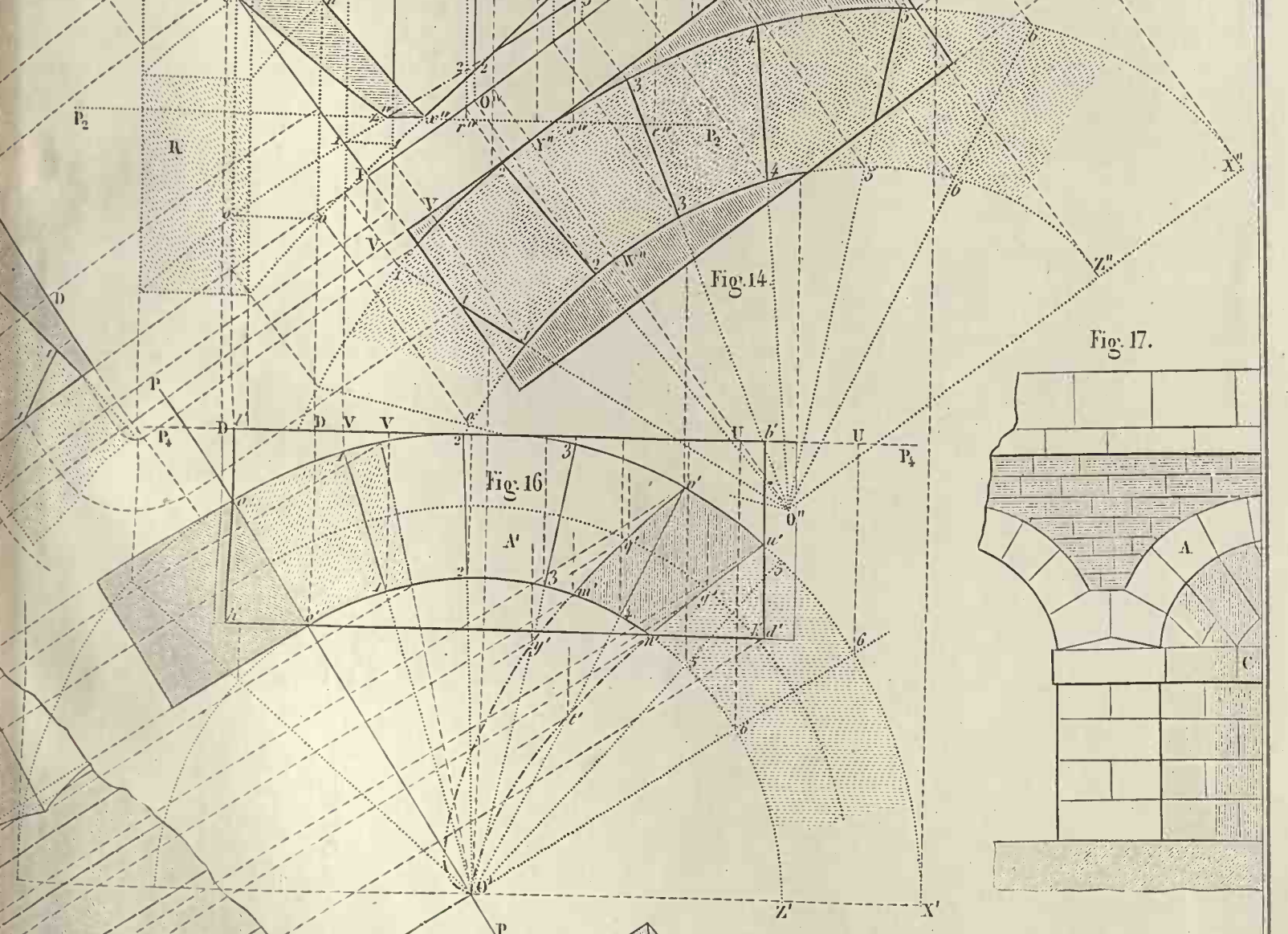


Fig. 14.

Fig. 16.

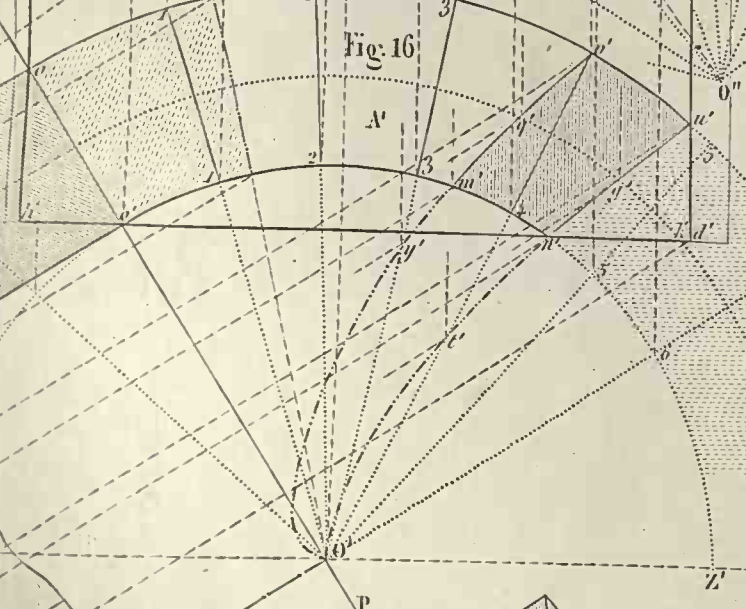


Fig. 17.

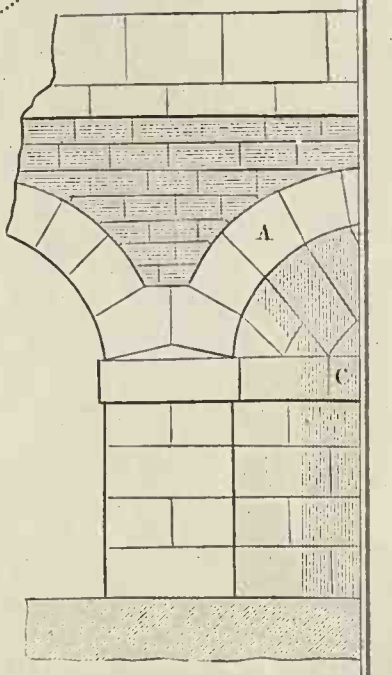


Fig. 19.

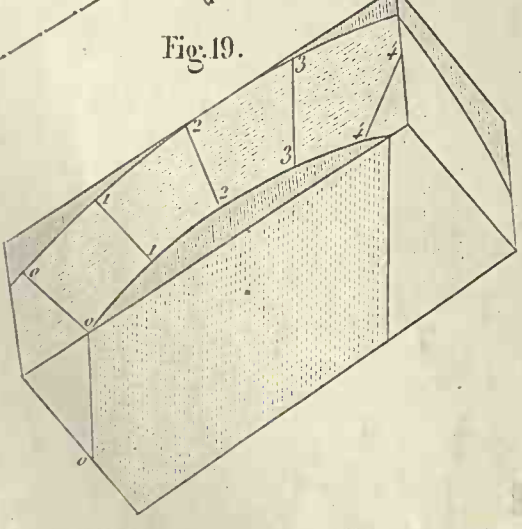


Fig. 20.

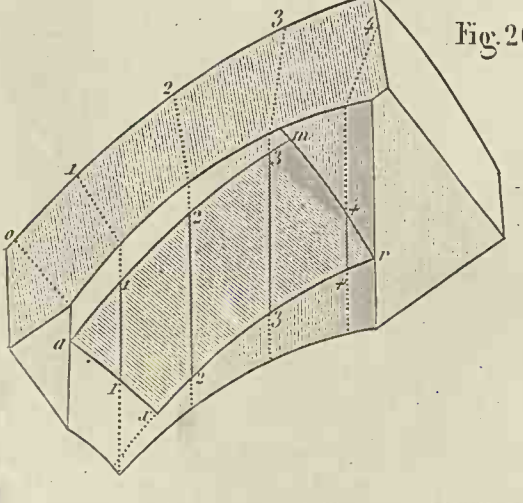


Fig. 18.

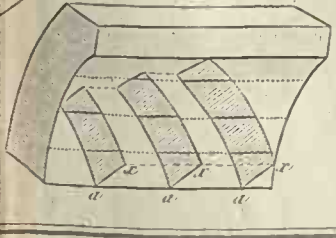


Fig. 1.

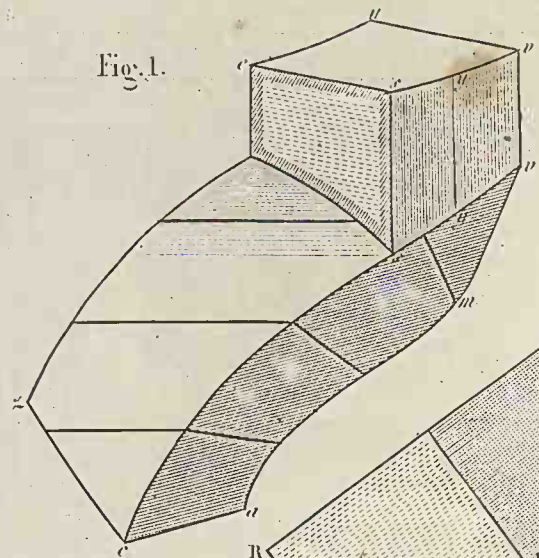


Fig. 2.



Fig. 3.

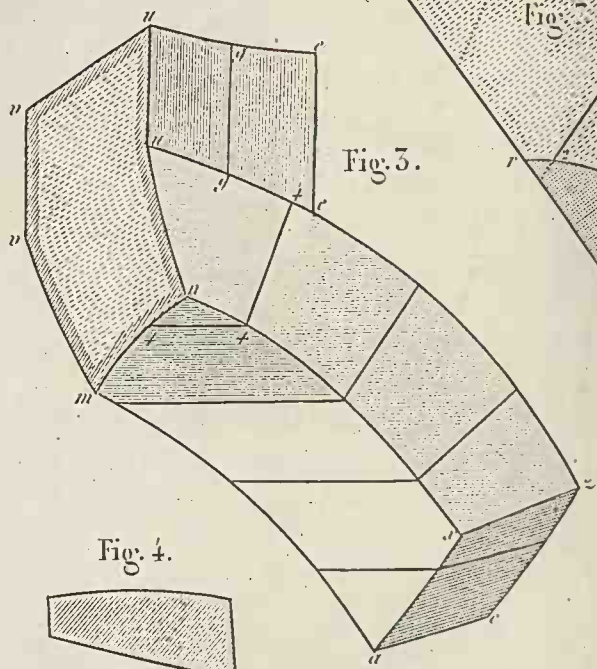


Fig. 4.



Fig. 5.

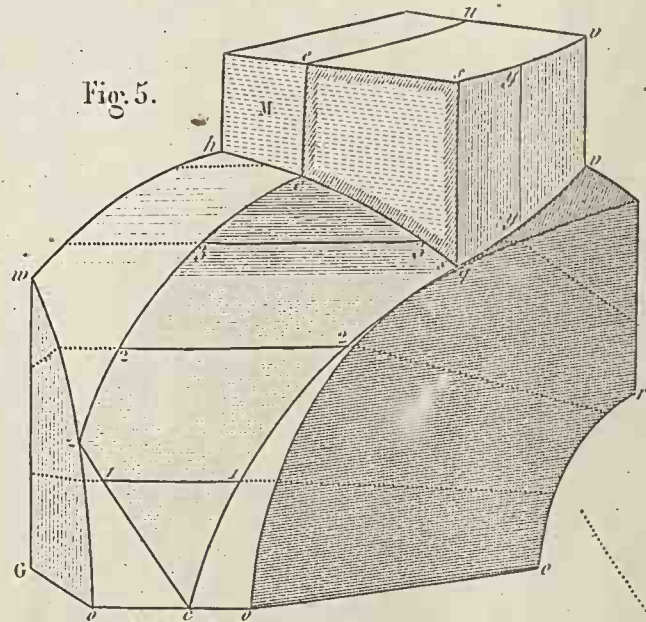


Fig. 6.



Fig. 8.

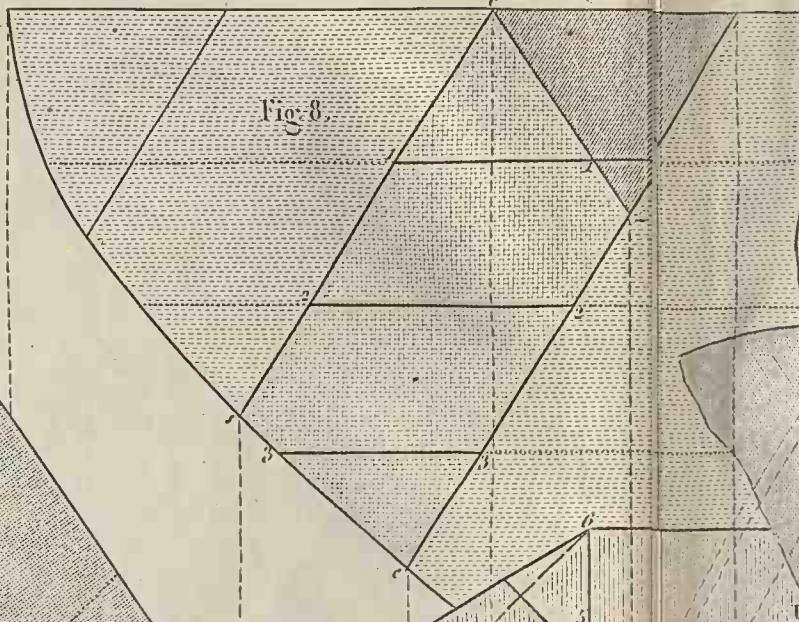


Fig. 15.

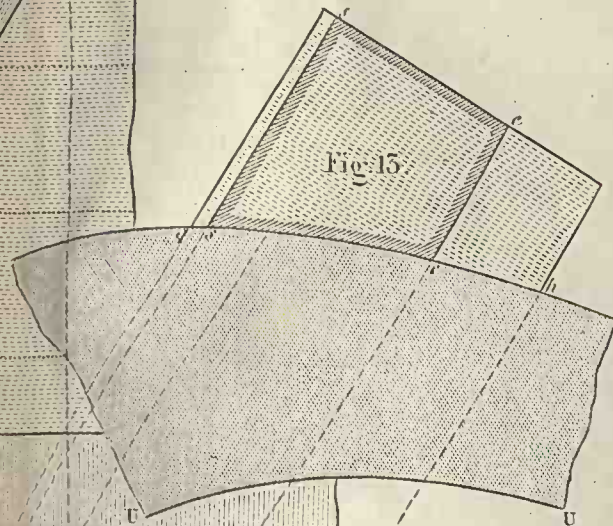


Fig. 18.

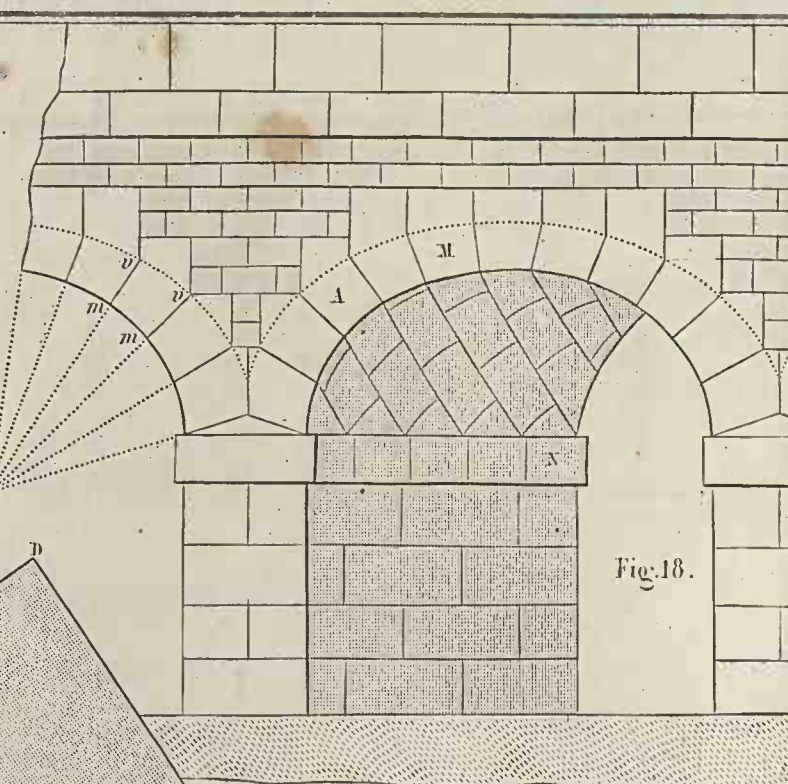


Fig. 19.

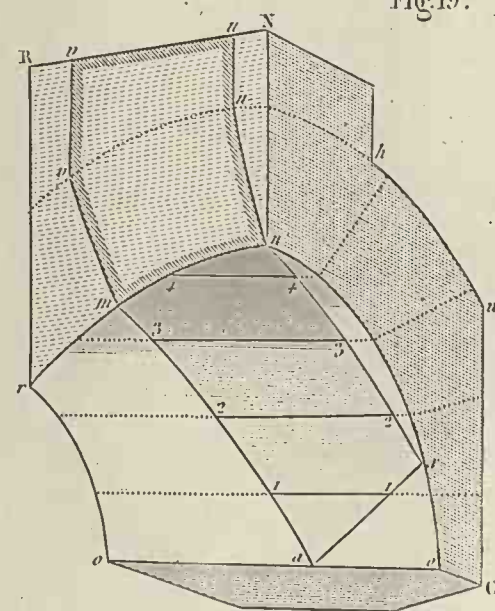


Fig. 20.

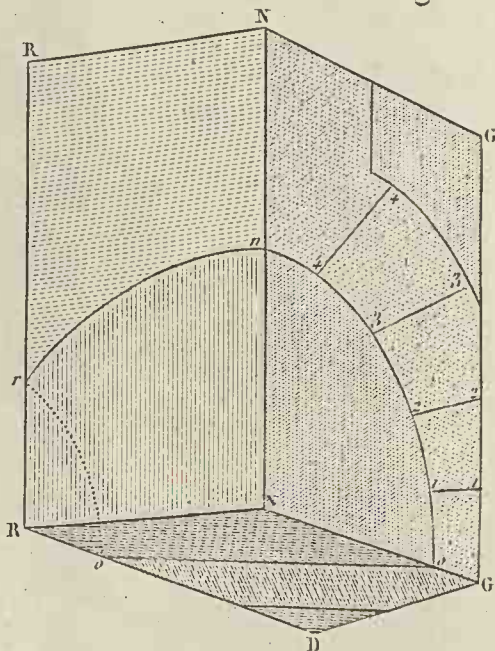


Fig. 15.

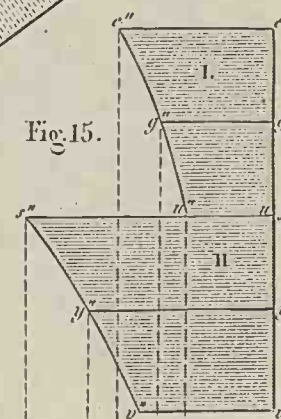


Fig. 16.

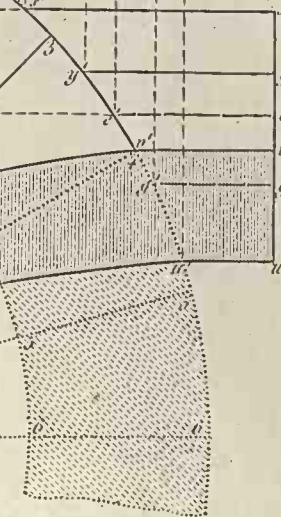


Fig. 17.

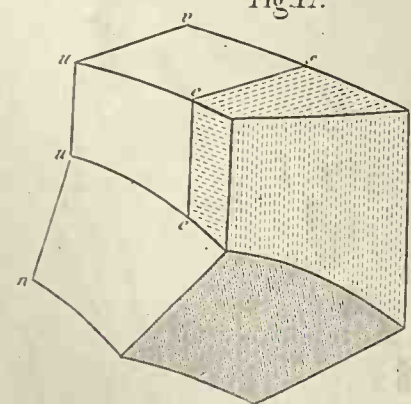


Fig. 12.

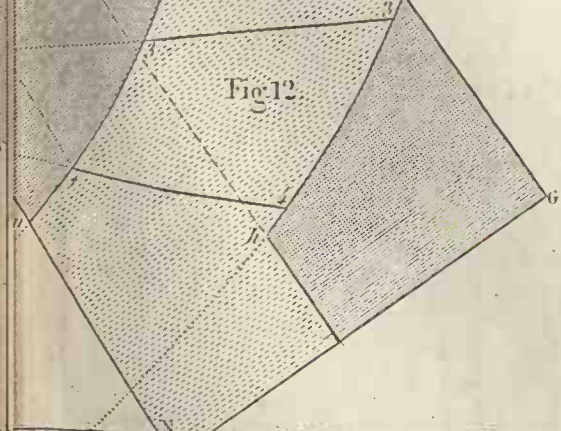


Fig. 10.

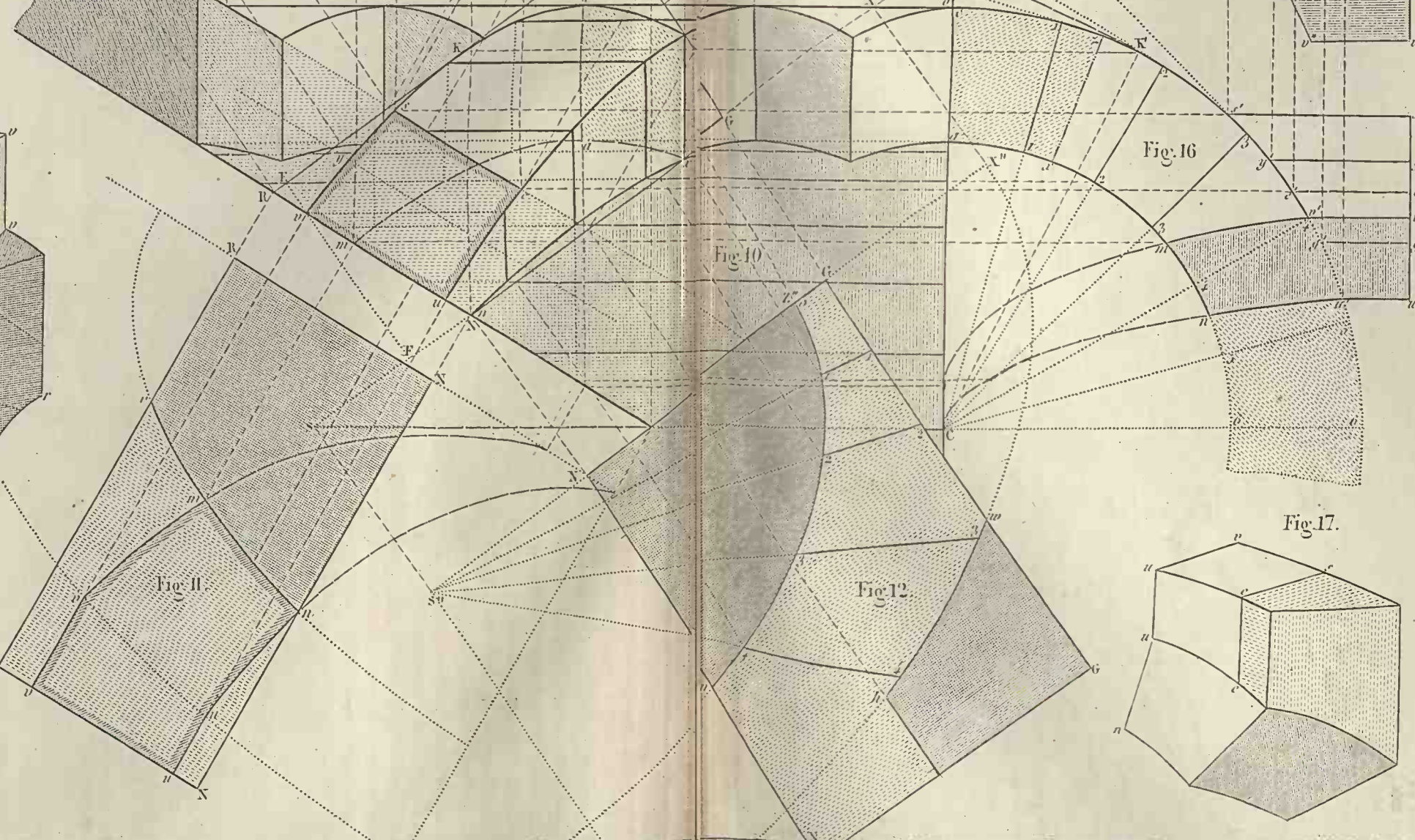


Fig. 9.

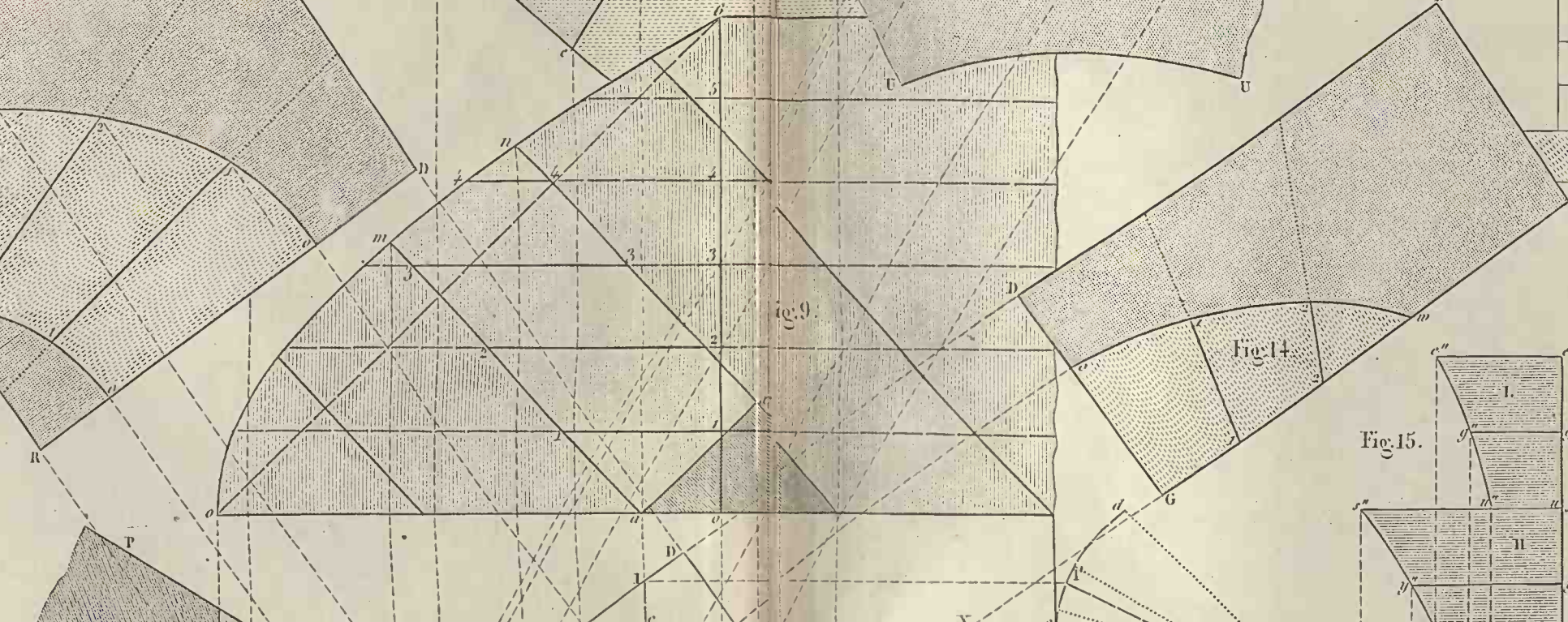


Fig. 7.

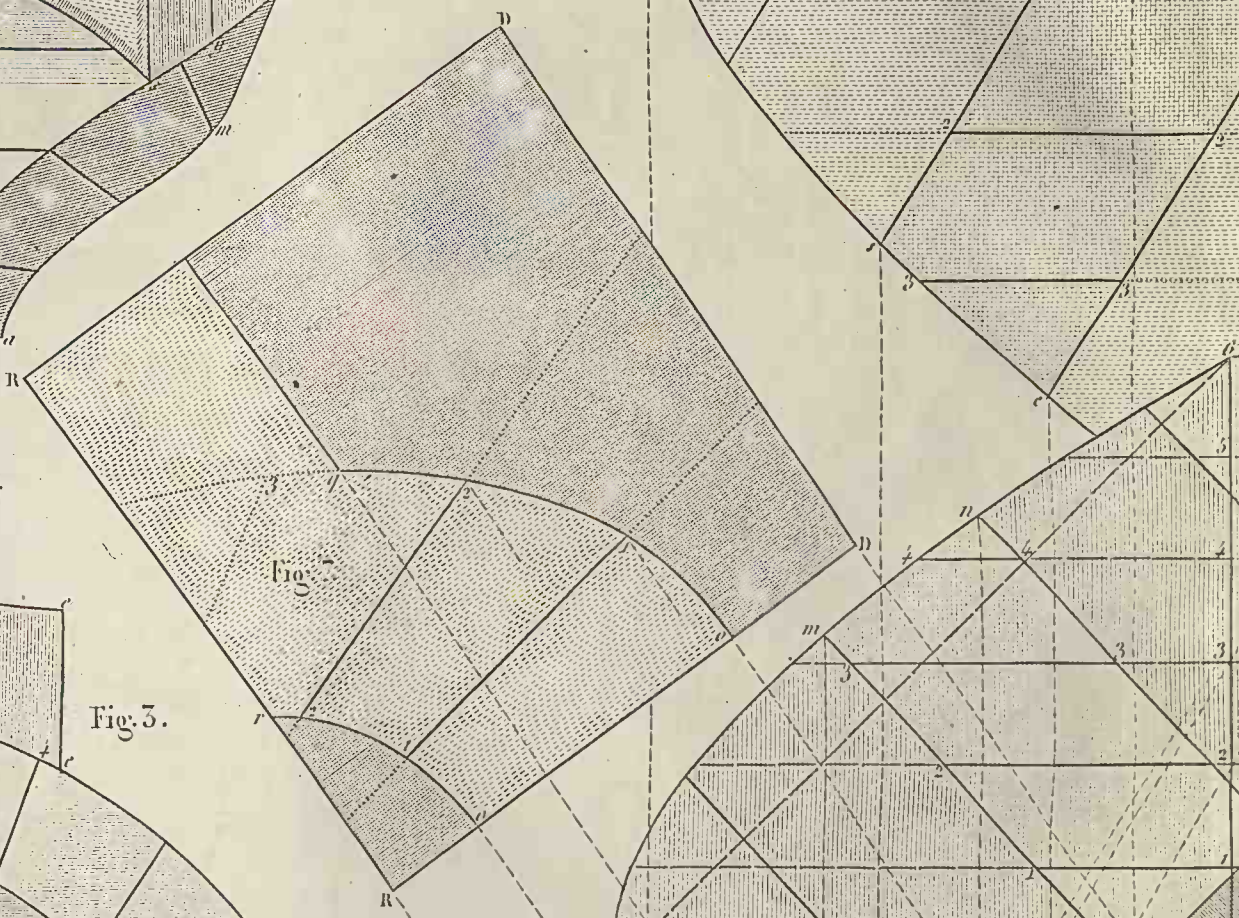


Fig. 1.

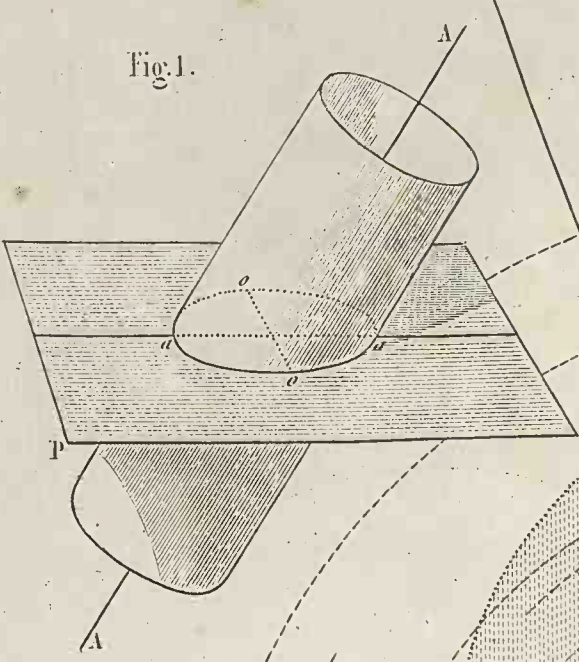


Fig. 2.

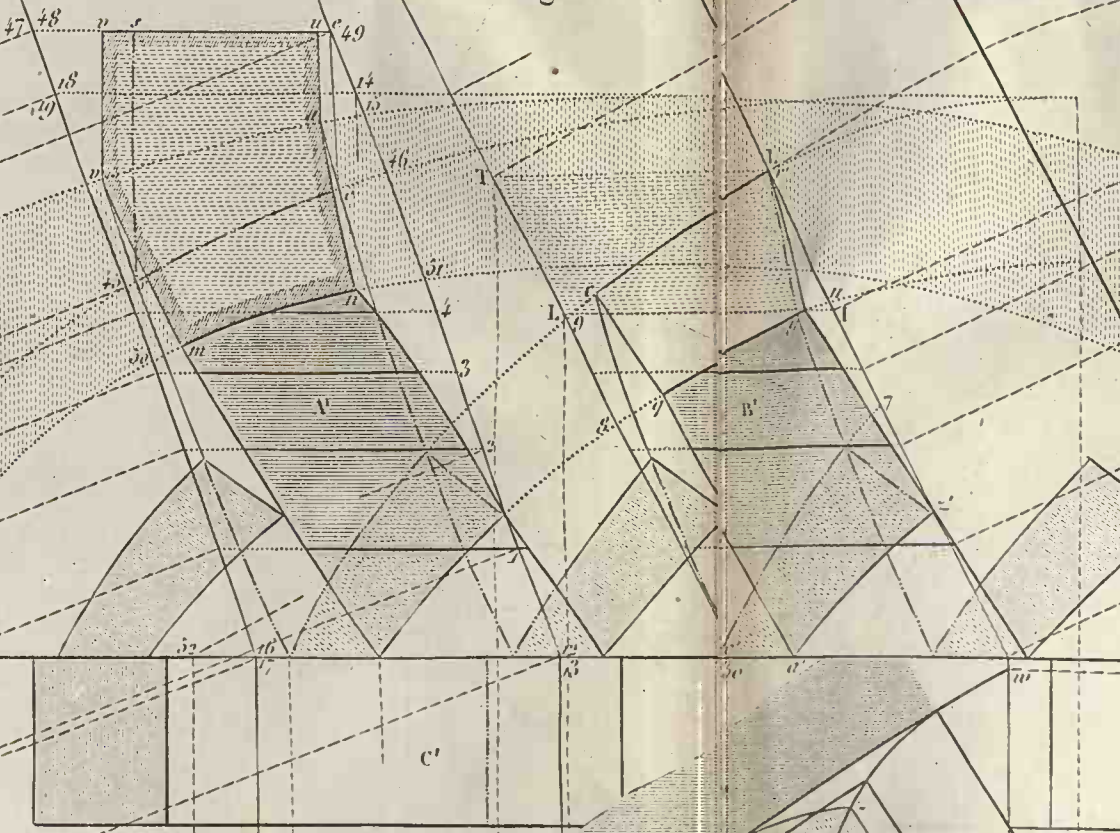


Fig. 5.

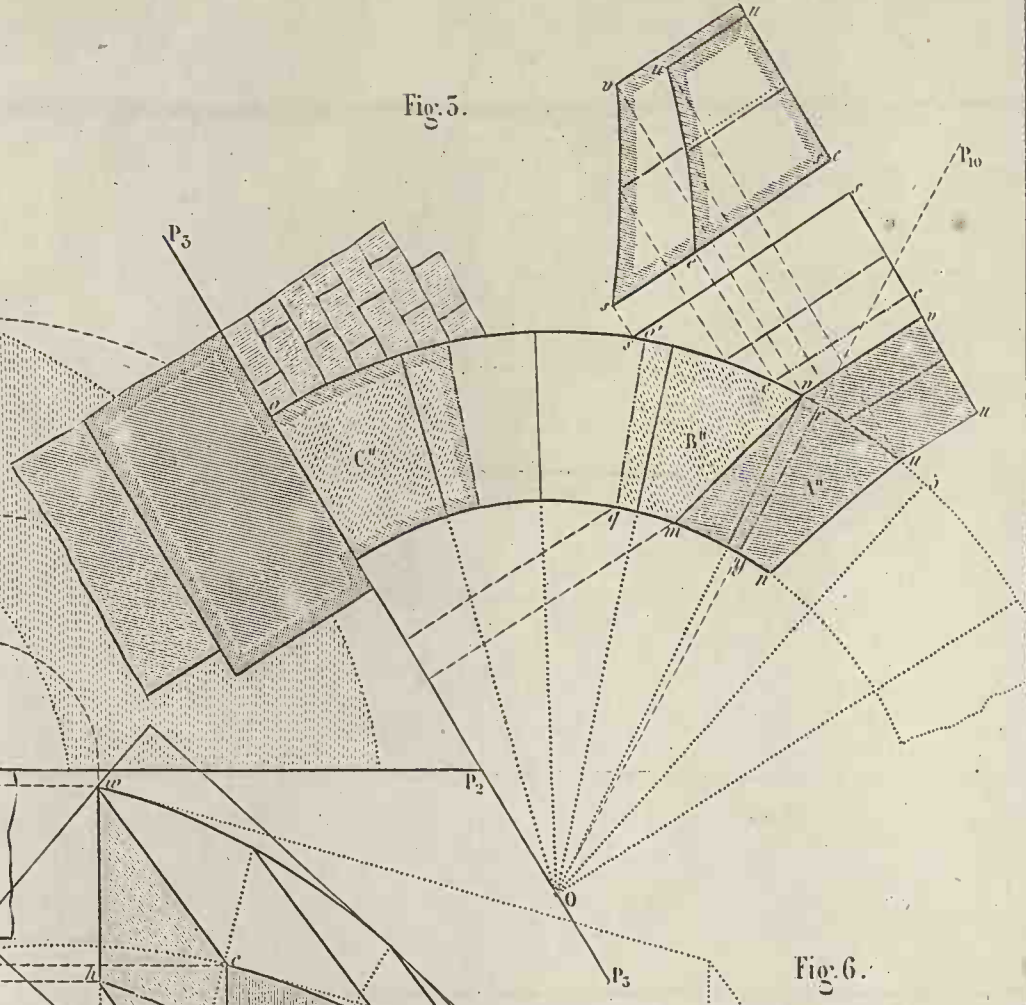


Fig. 4.

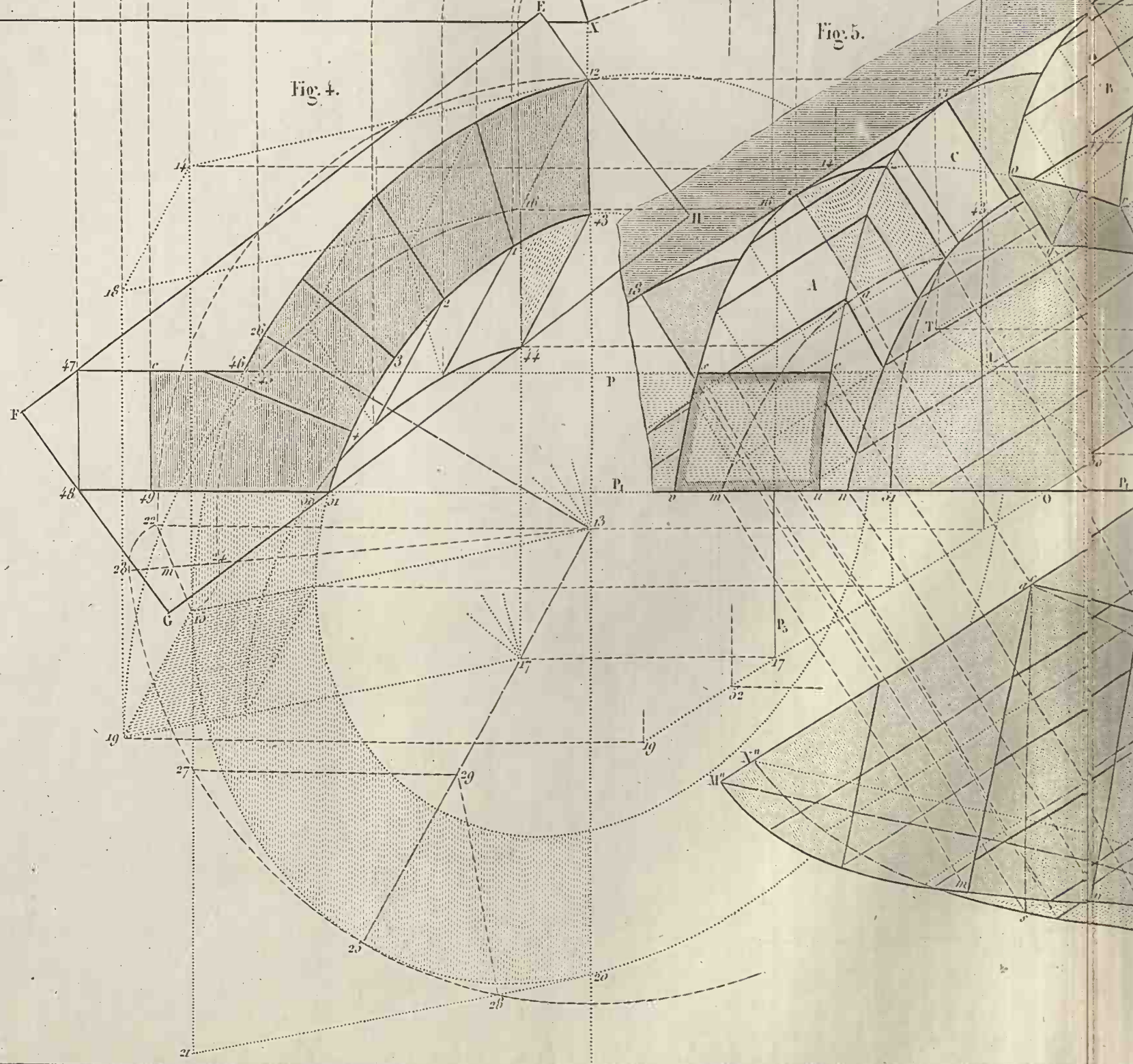


Fig. 5.

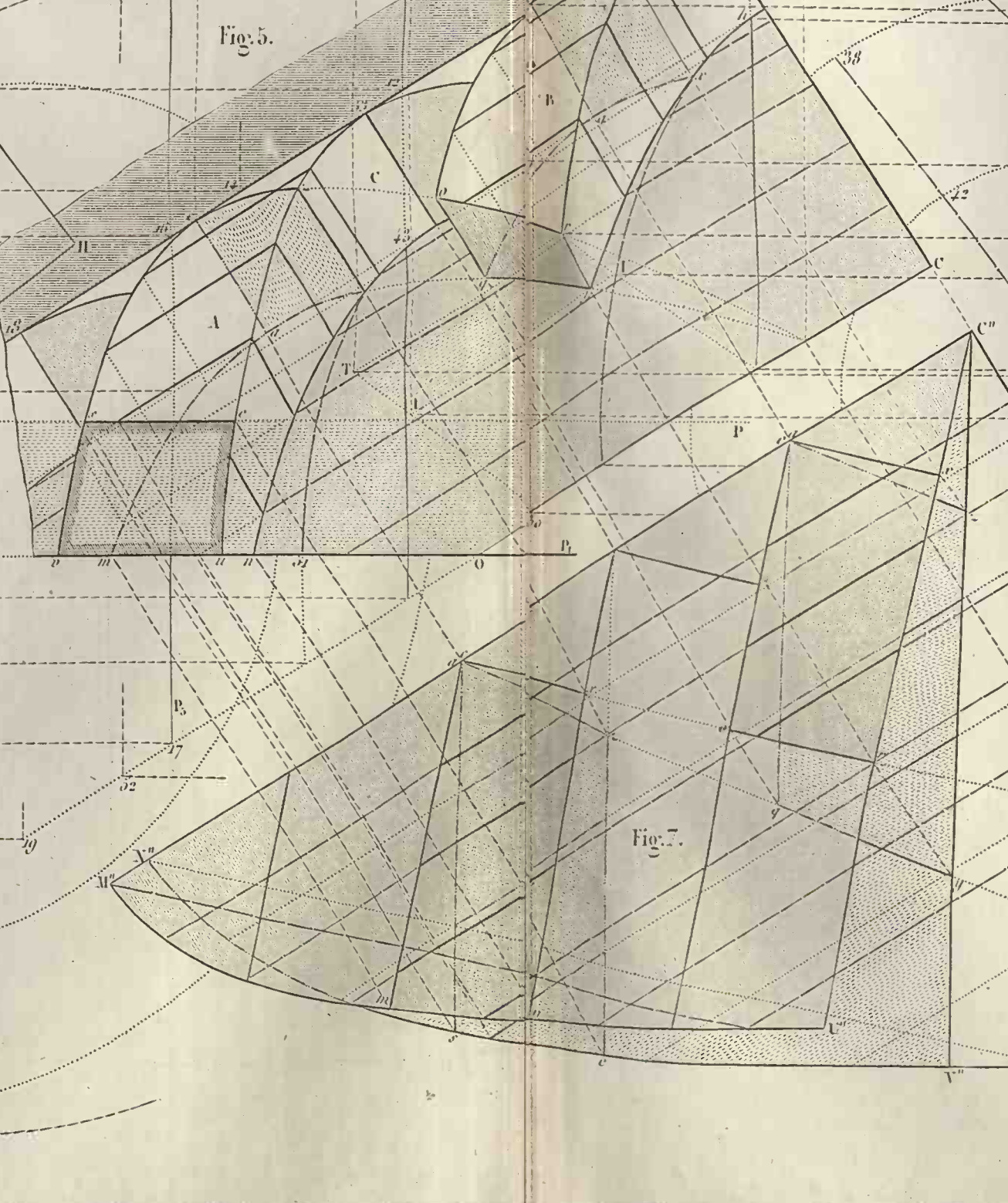


Fig. 6.

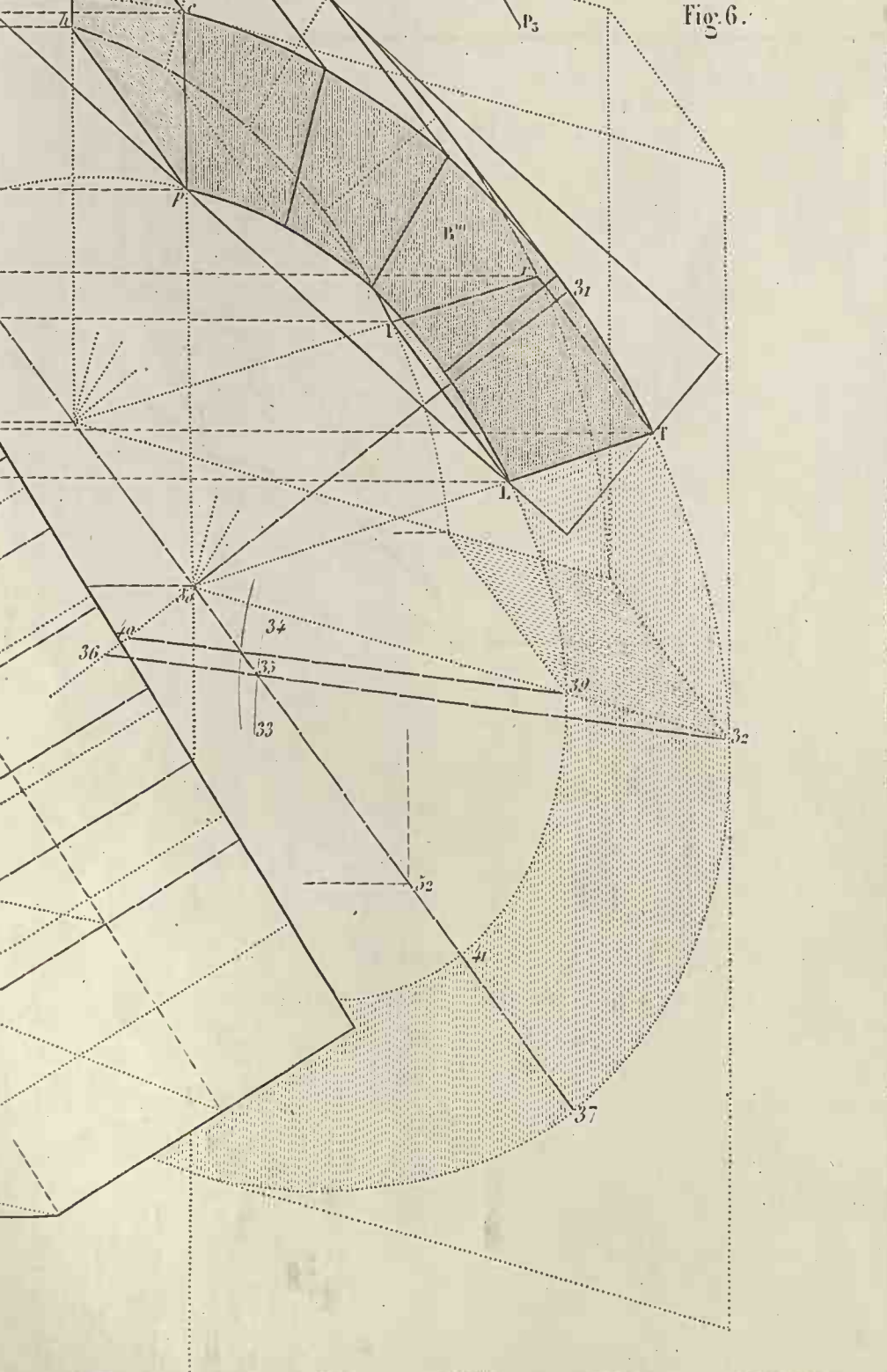


Fig. 7.

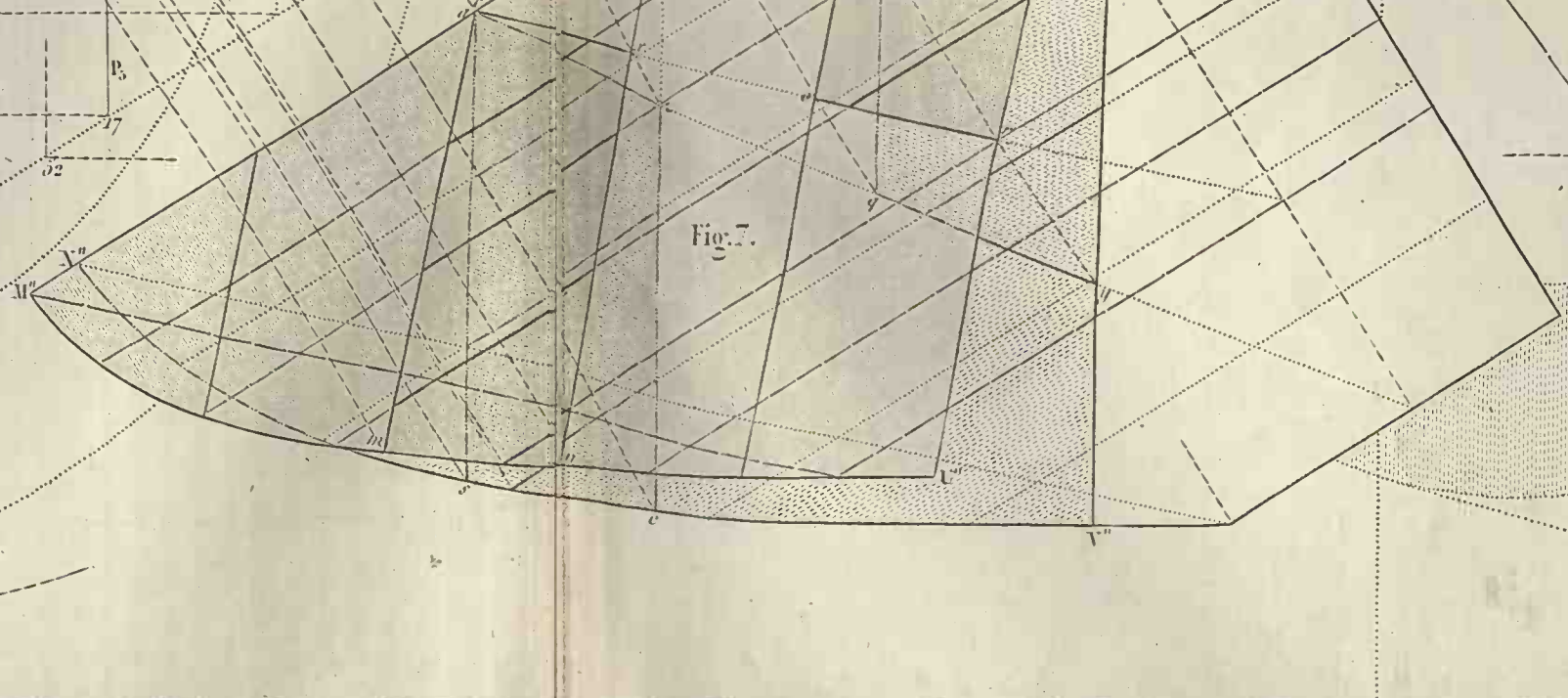


Fig. 1.

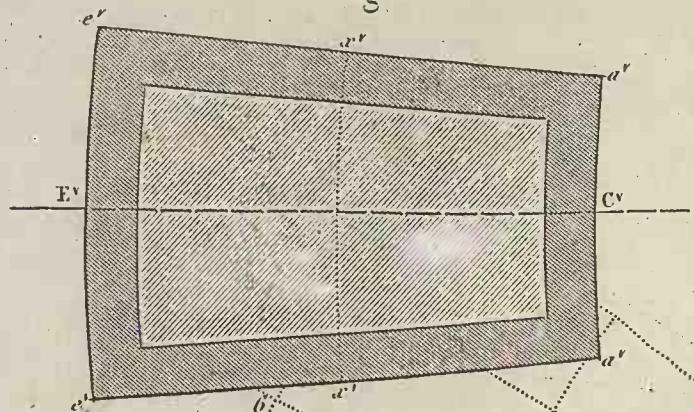


Fig. 7.

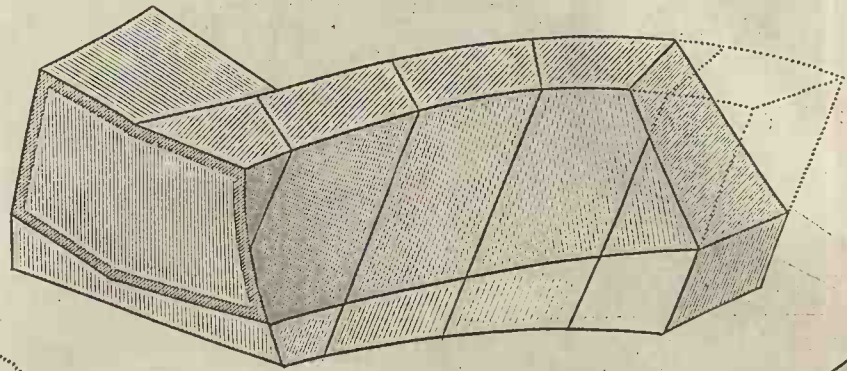


Fig. 5.

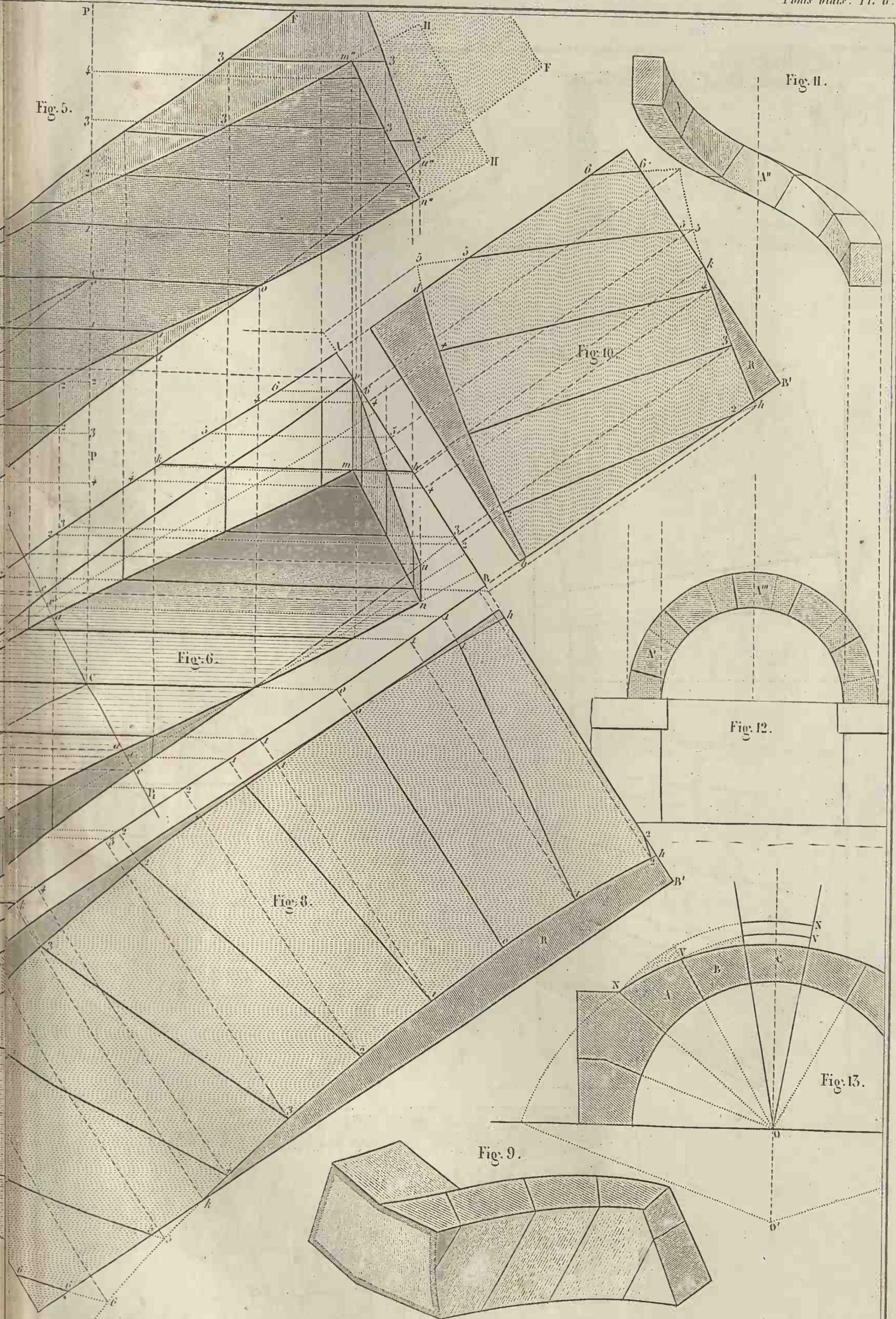


Fig. 11.

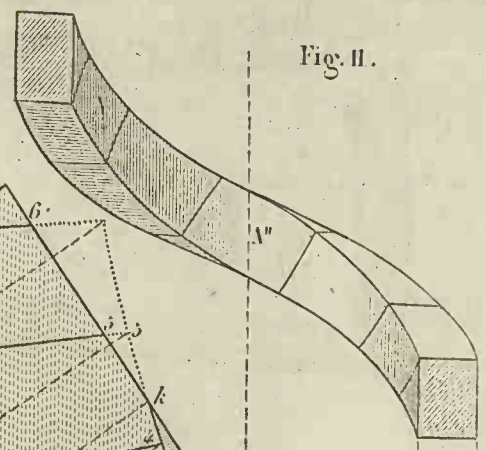


Fig. 3.

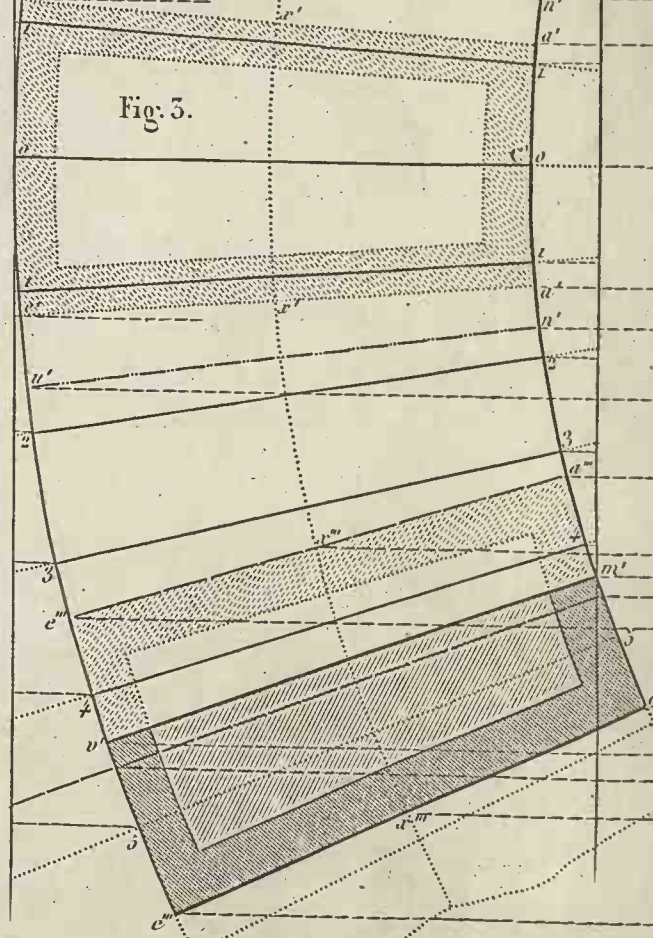


Fig. 4.

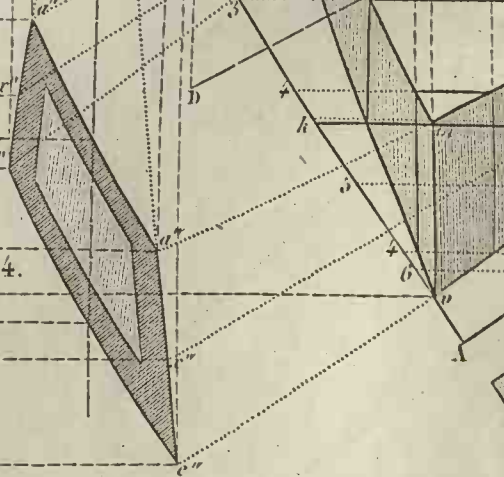


Fig. 2.

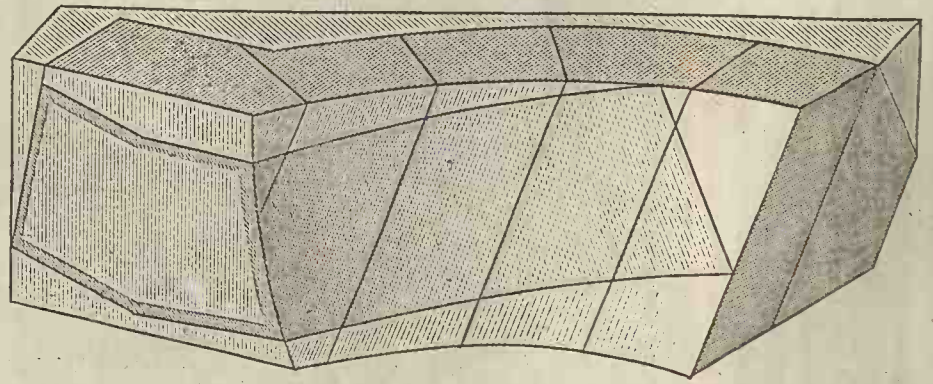


Fig. 6.

Fig. 8.

Fig. 9.

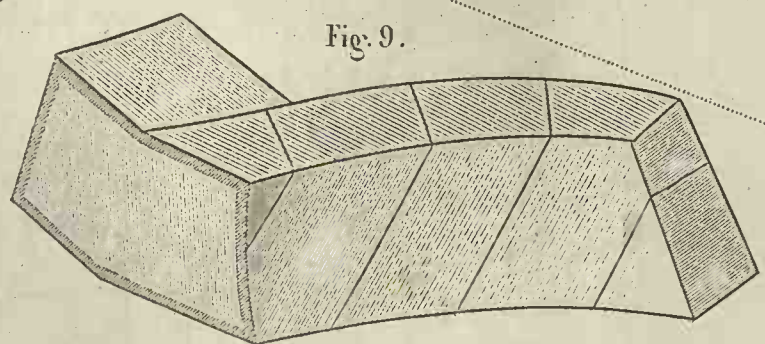


Fig. 12.

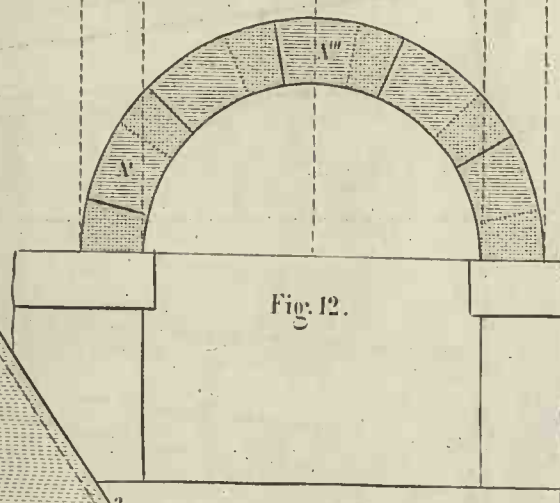
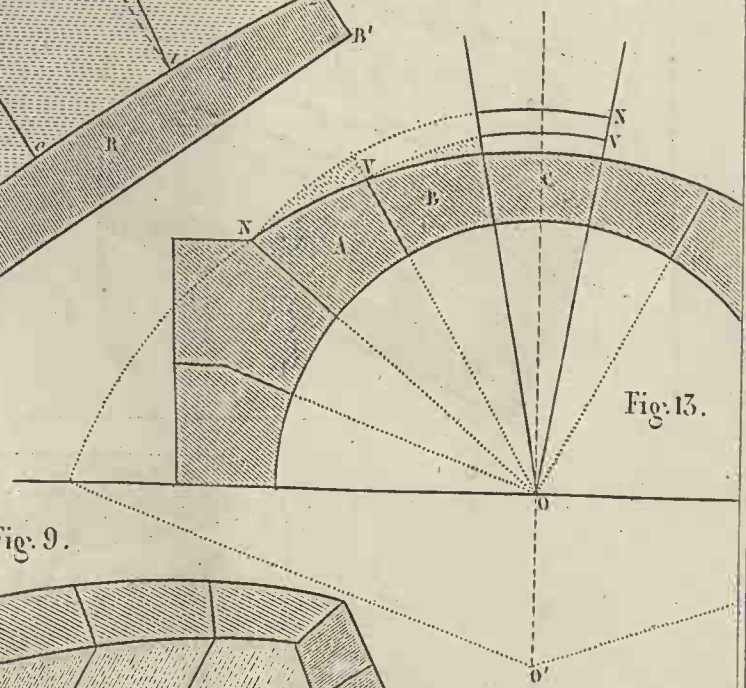
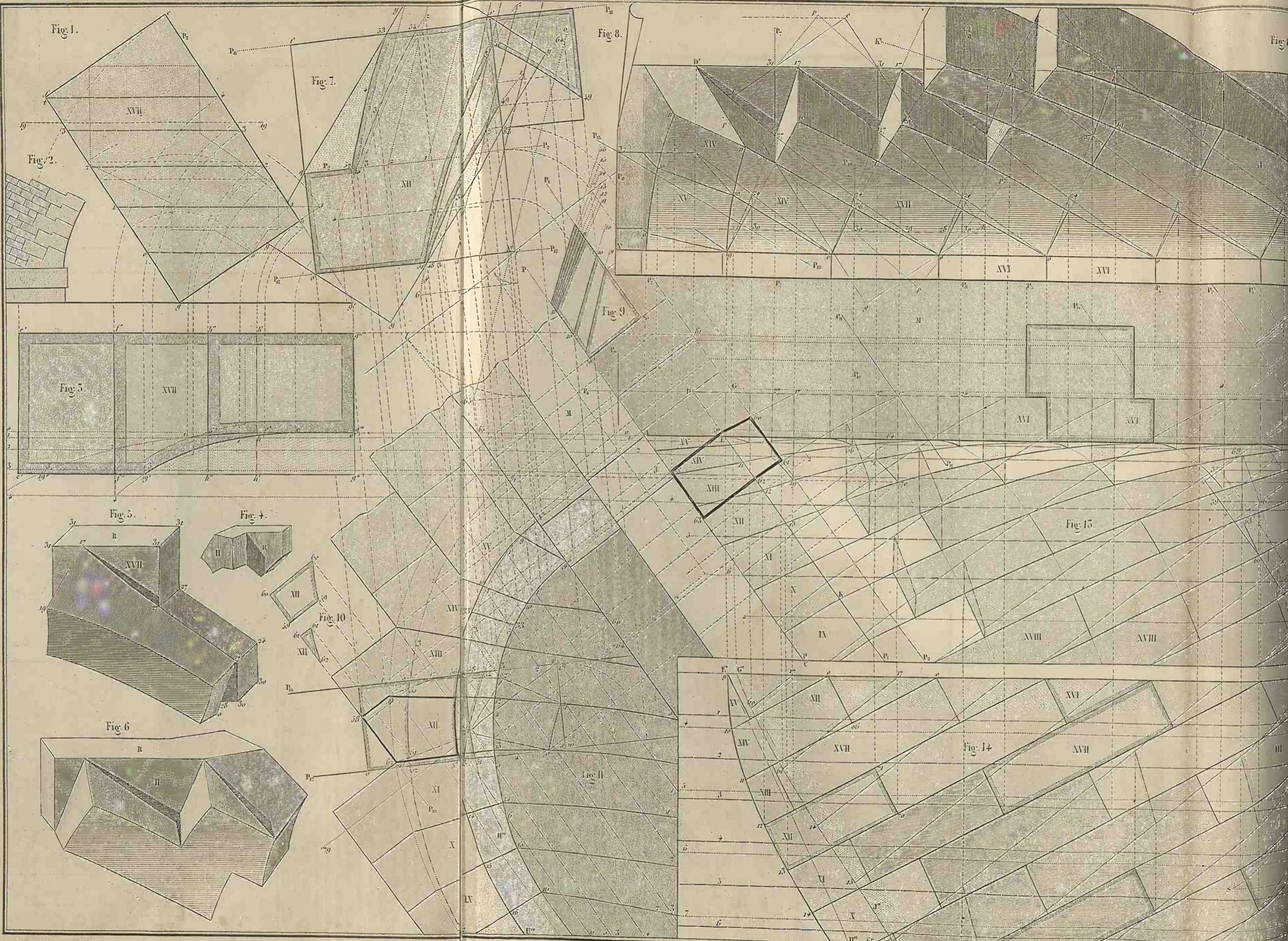


Fig. 13.





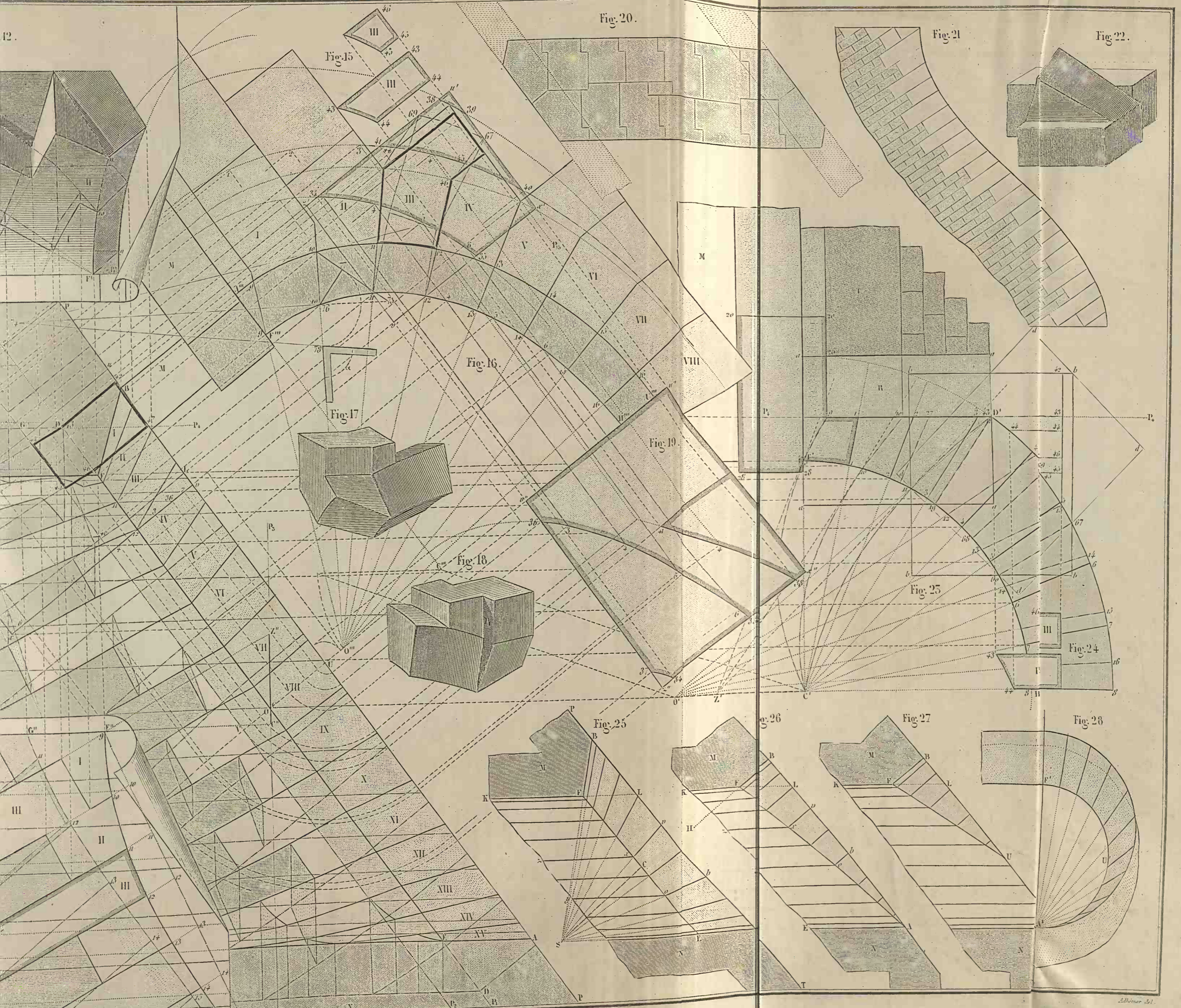


Fig. 1.

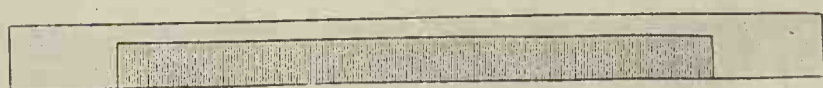


Fig. 4.

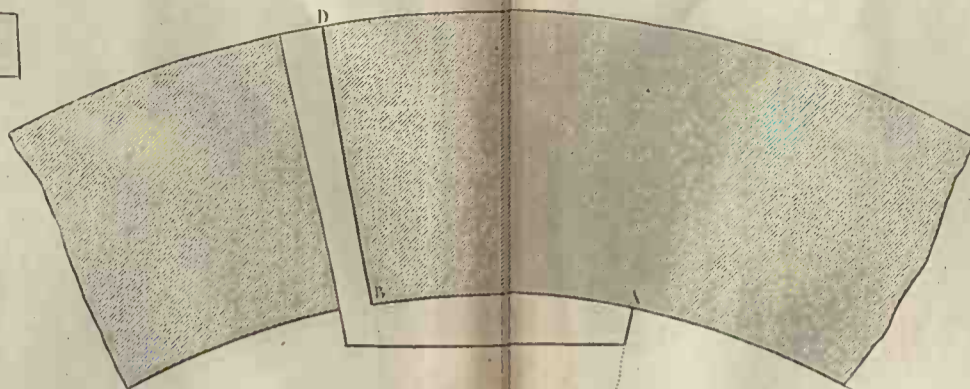


Fig. 5.

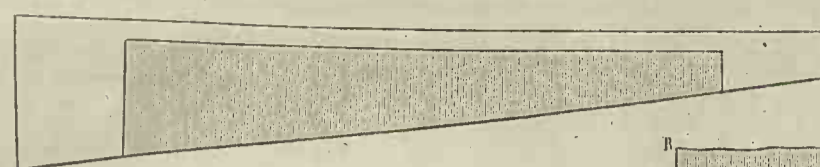


Fig. 2.

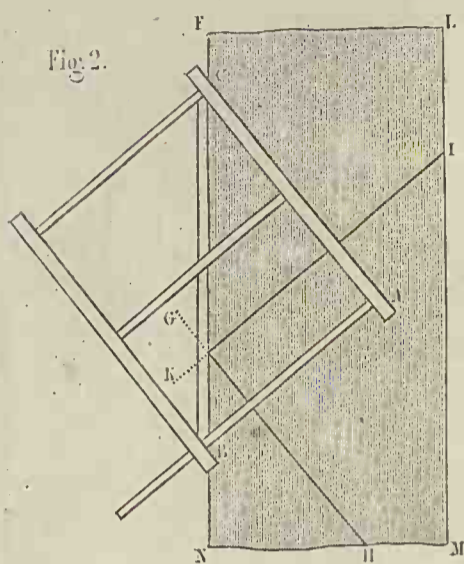


Fig. 3.

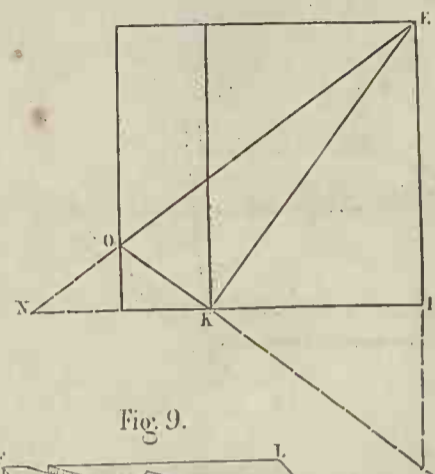


Fig. 6.

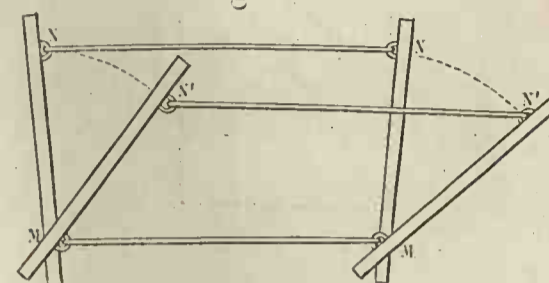


Fig. 7.

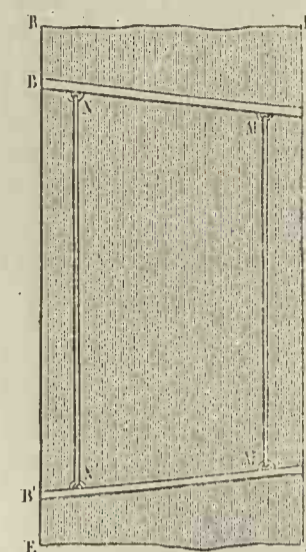


Fig. 9.

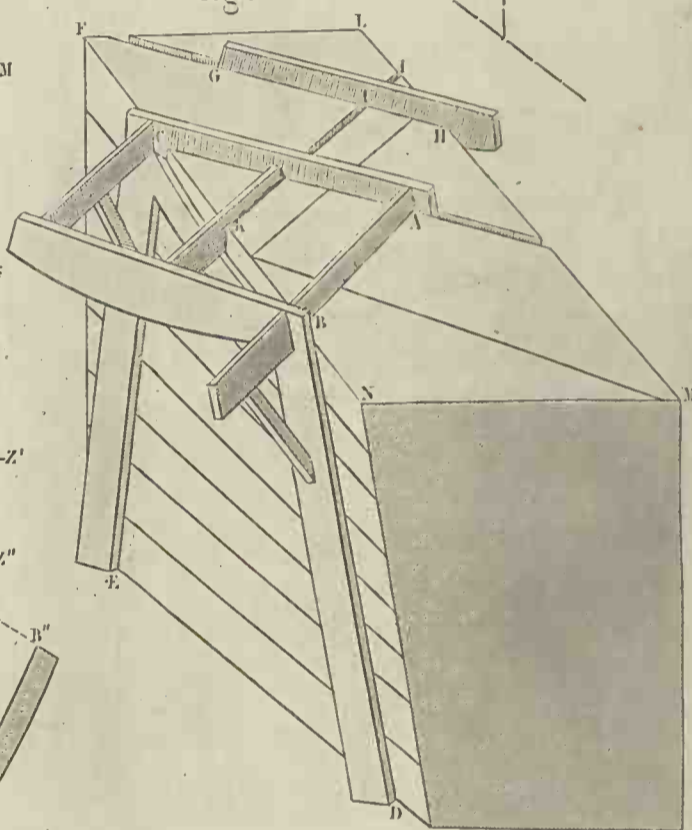


Fig. 10.

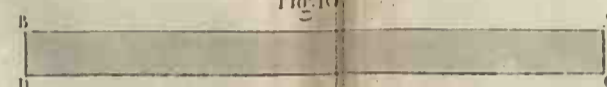


Fig. 11.

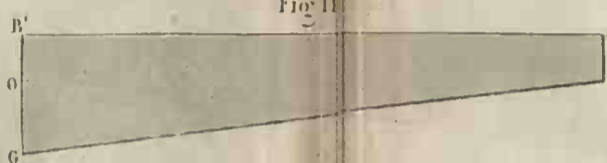


Fig. 14.

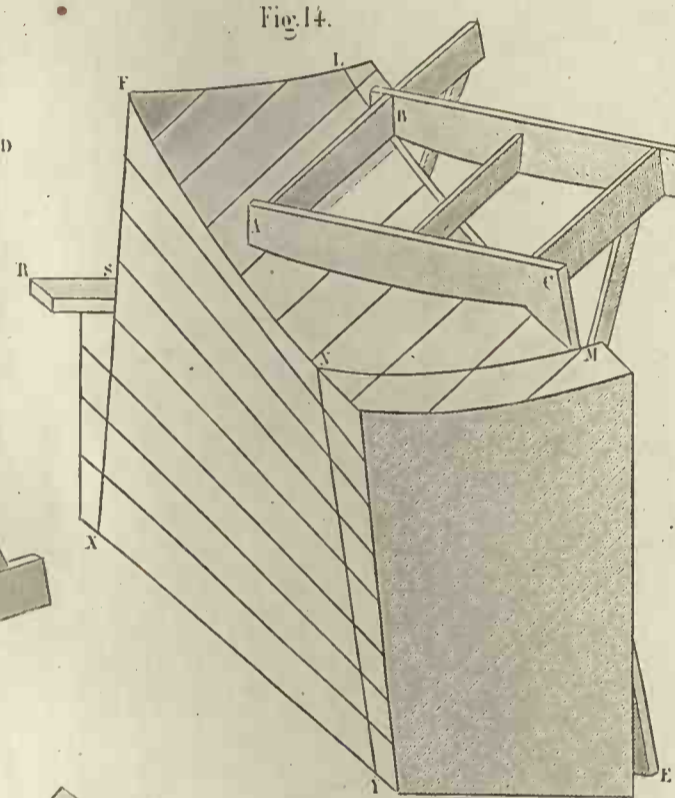


Fig. 15.

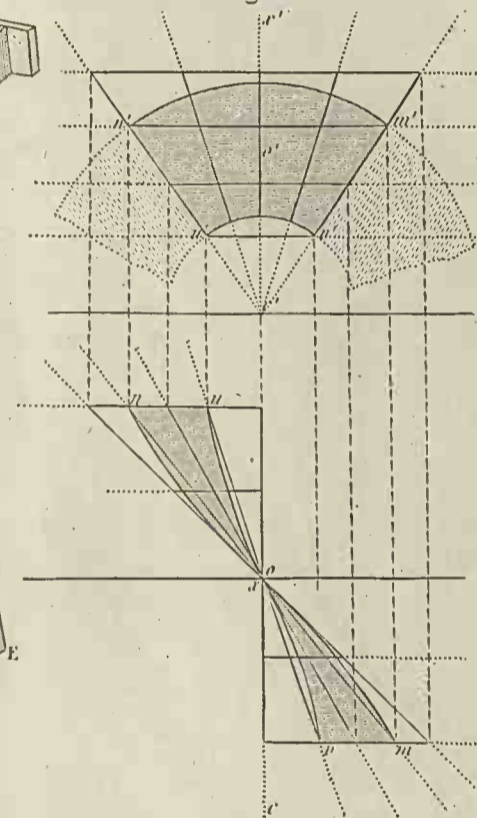


Fig. 8.

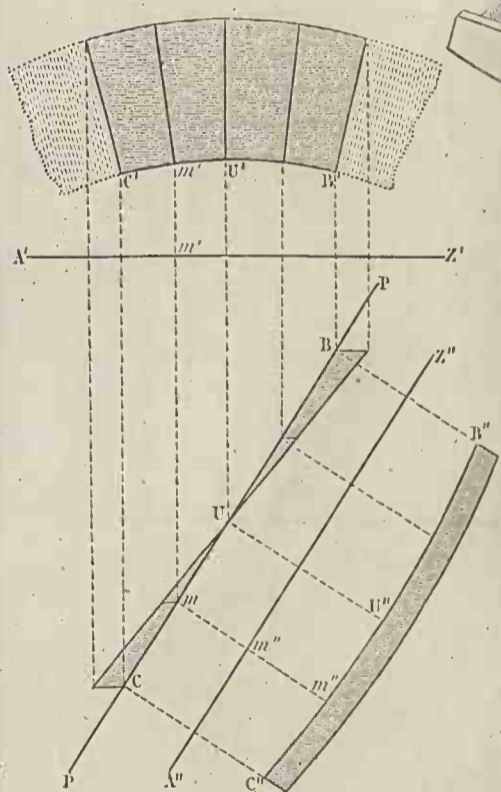


Fig. 13.



Fig. 16.

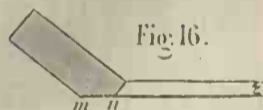


Fig. 17.

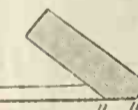


Fig. 18.

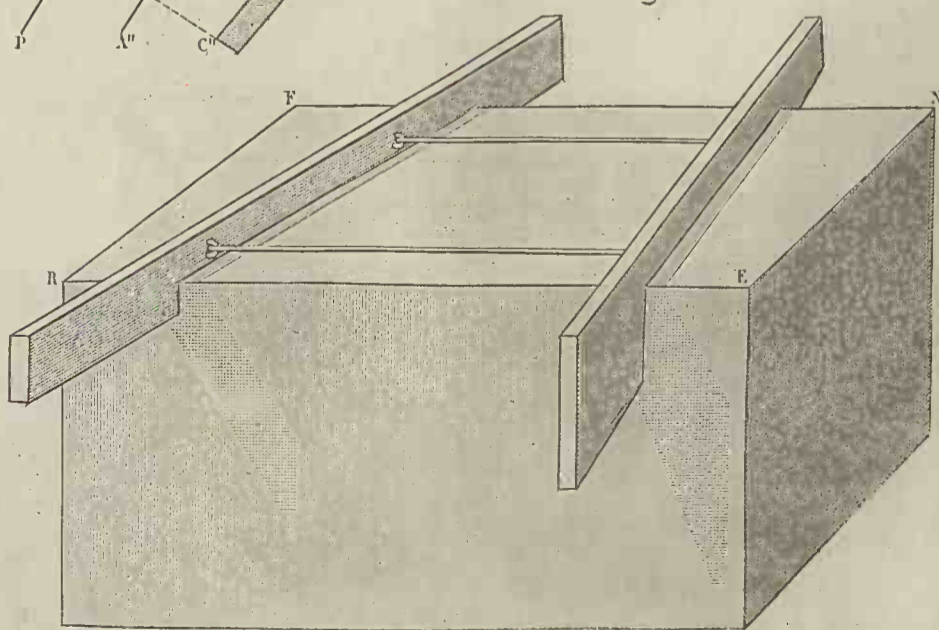


Fig. 19.

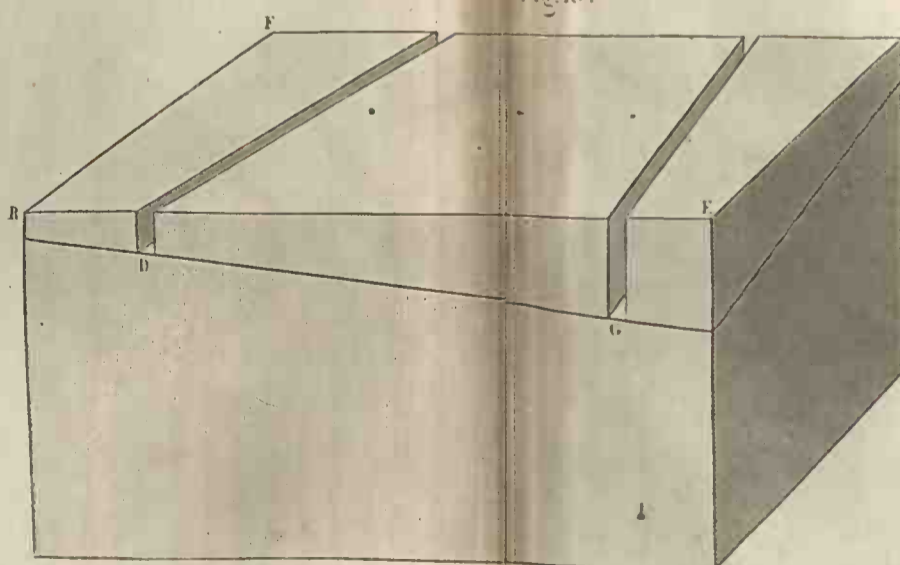


Fig. 20.

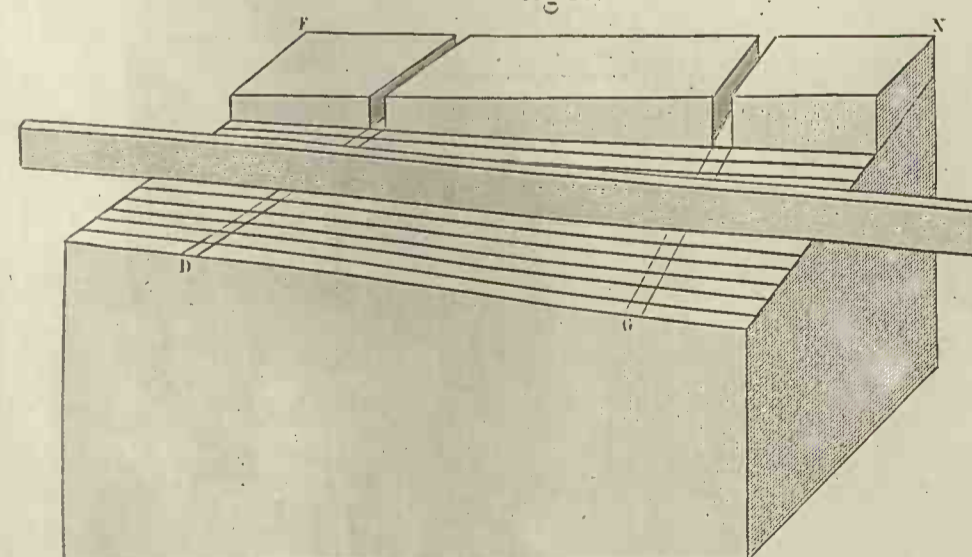


Fig. 1.

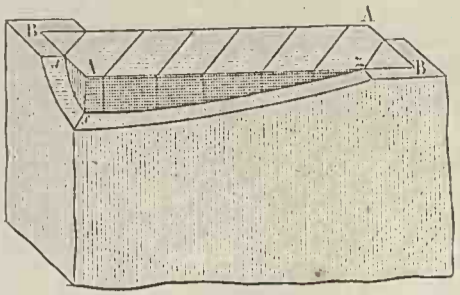


Fig. 2.

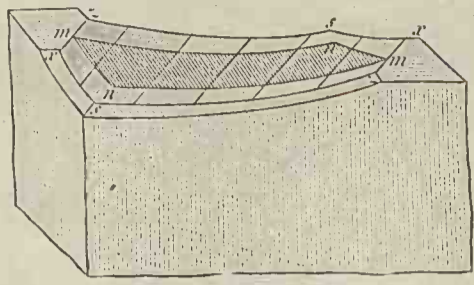


Fig. 4.

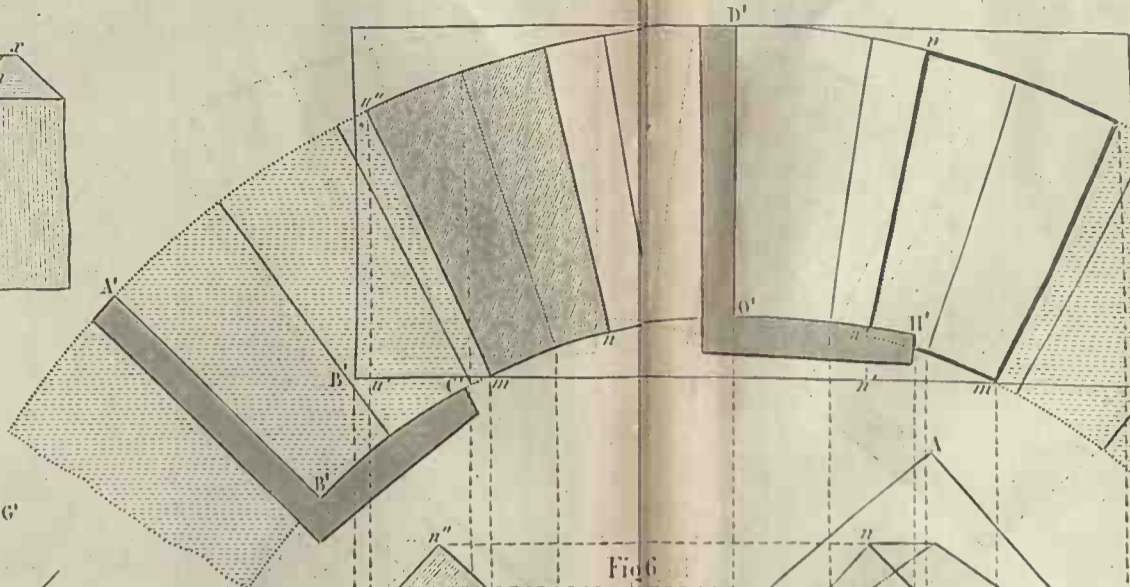


Fig. 9.

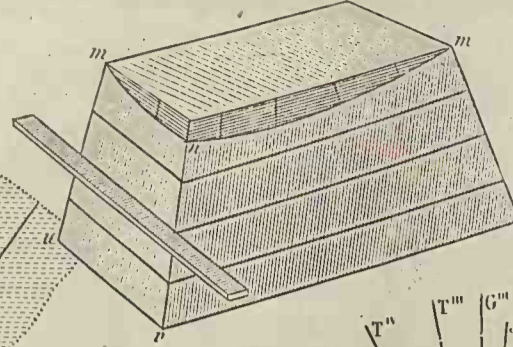


Fig. 10.

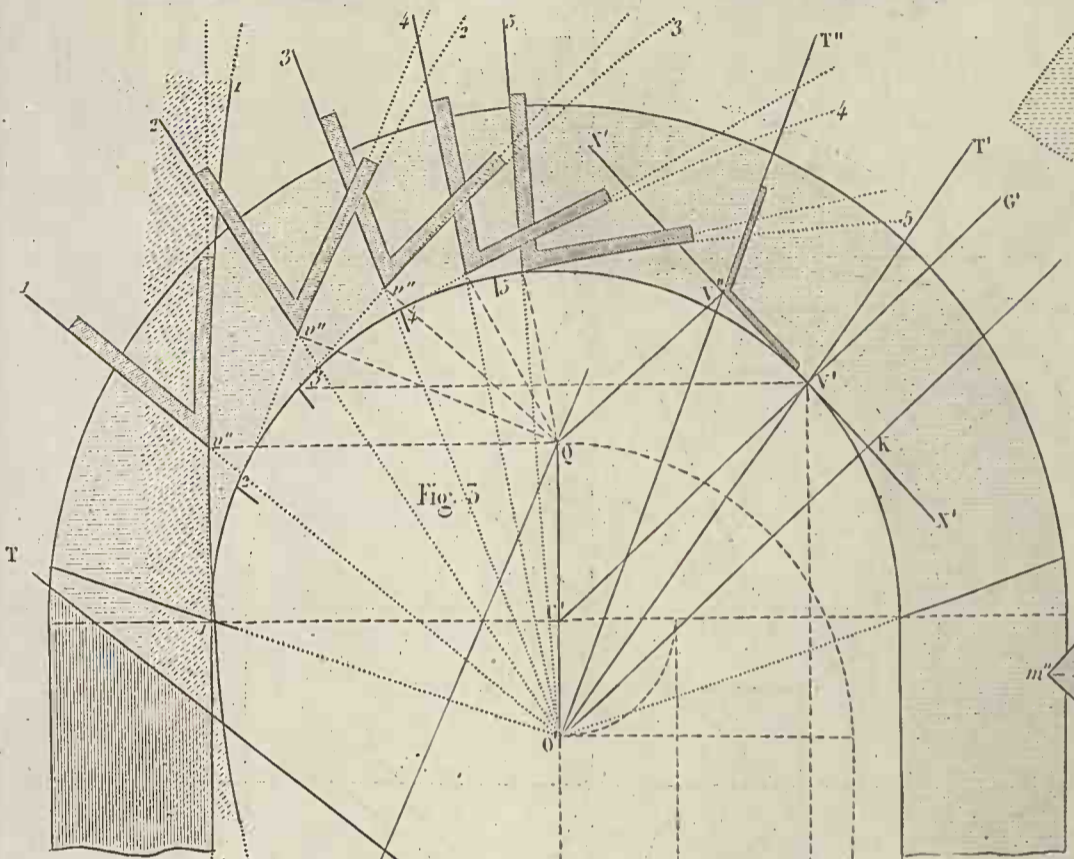
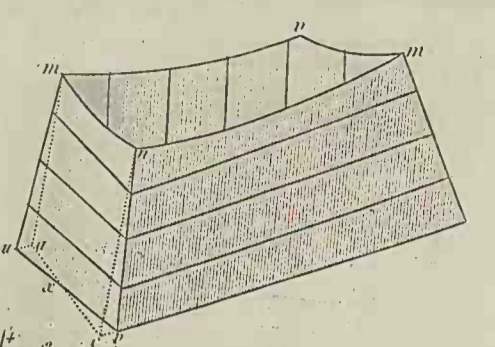


Fig. 5.

Fig. 6.

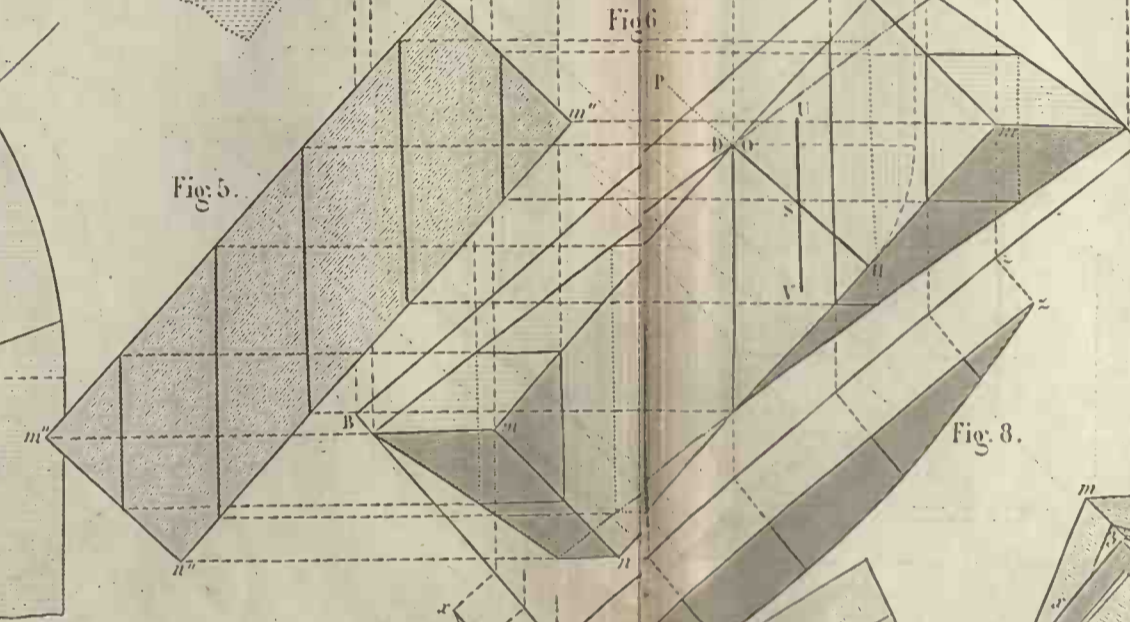


Fig. 8.

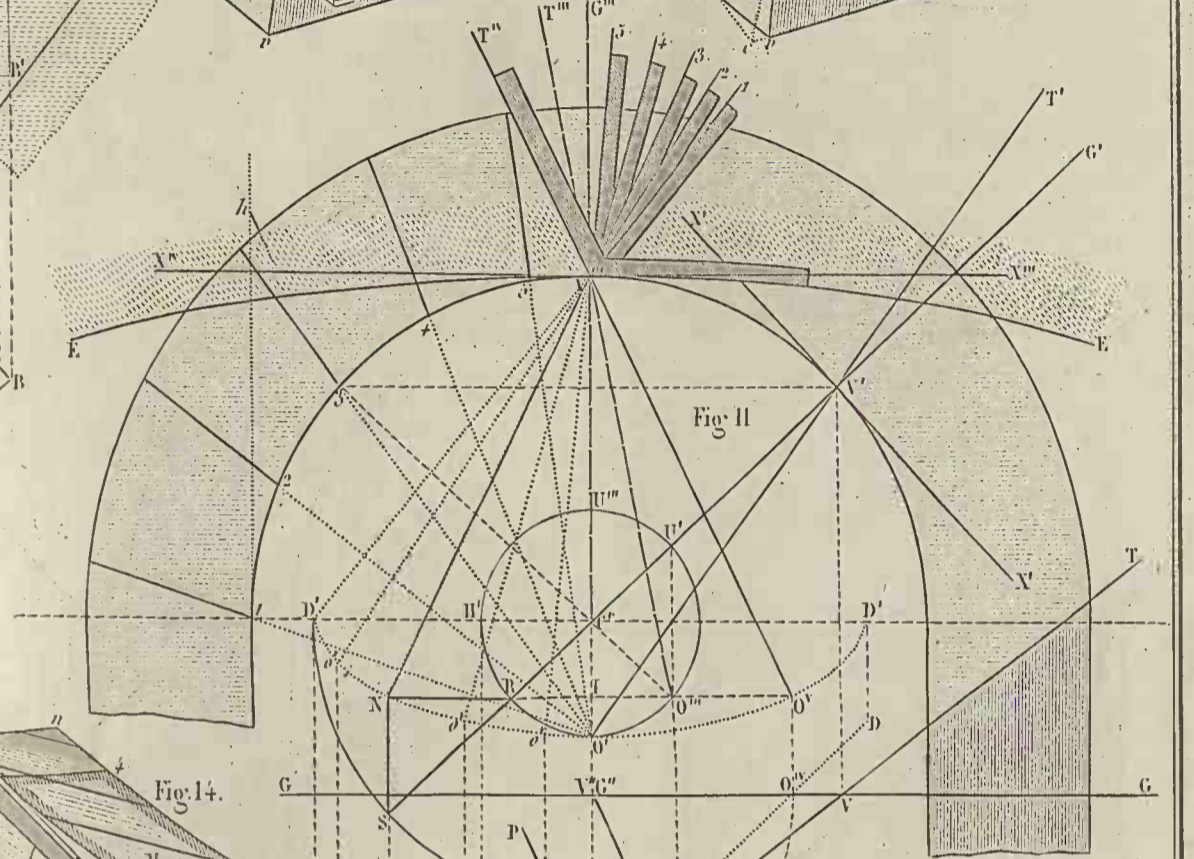


Fig. 11.

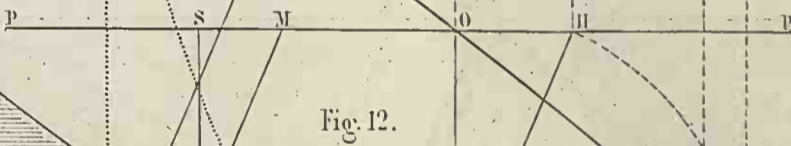


Fig. 12.

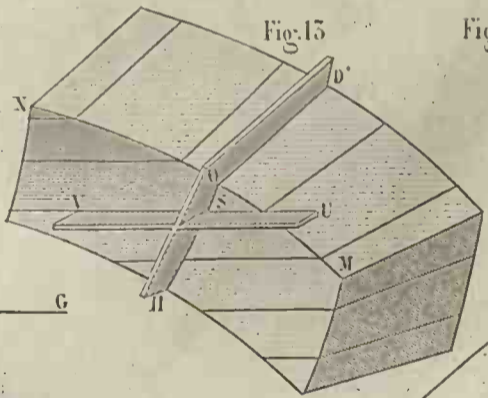


Fig. 15.

Fig. 7.

Fig. 17.

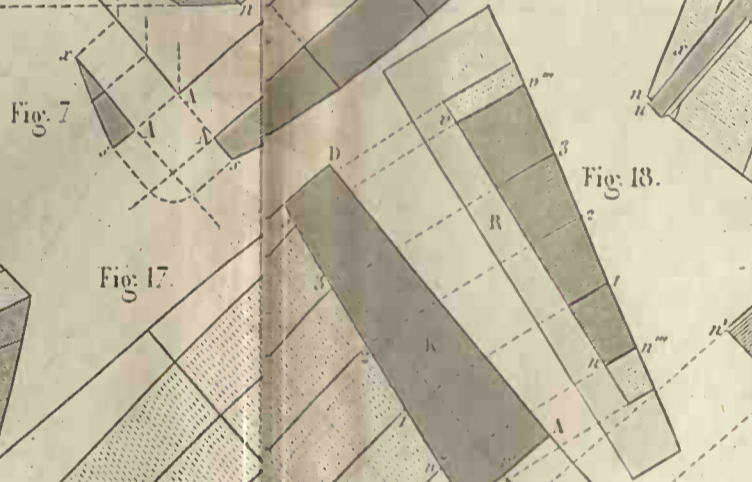


Fig. 13.

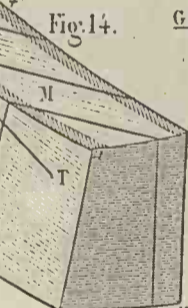


Fig. 14.

Fig. 19.

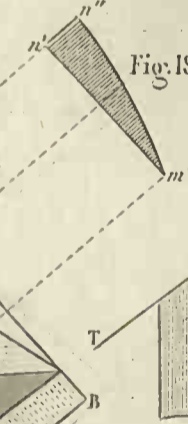


Fig. 15.

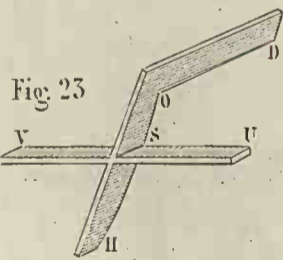


Fig. 23.

Fig. 24.

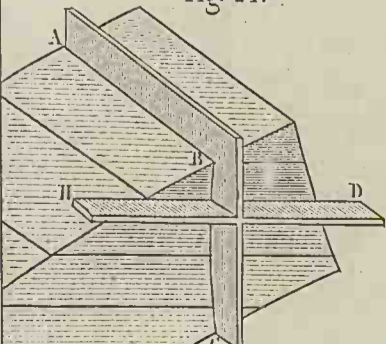


Fig. 25.

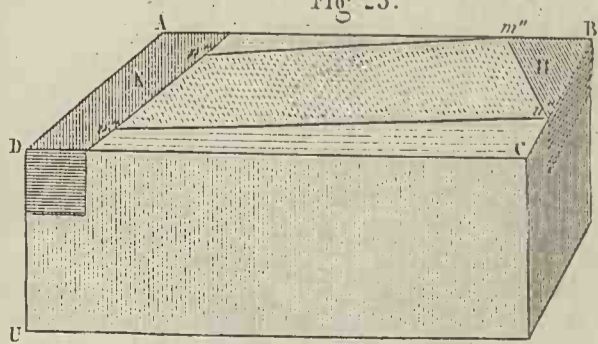


Fig. 21.

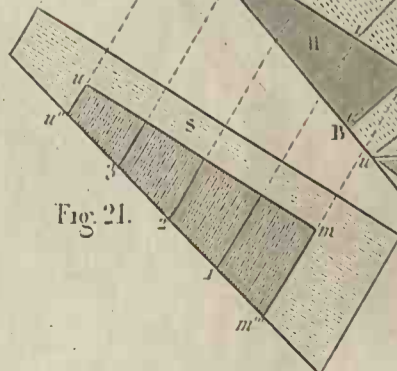


Fig. 20.

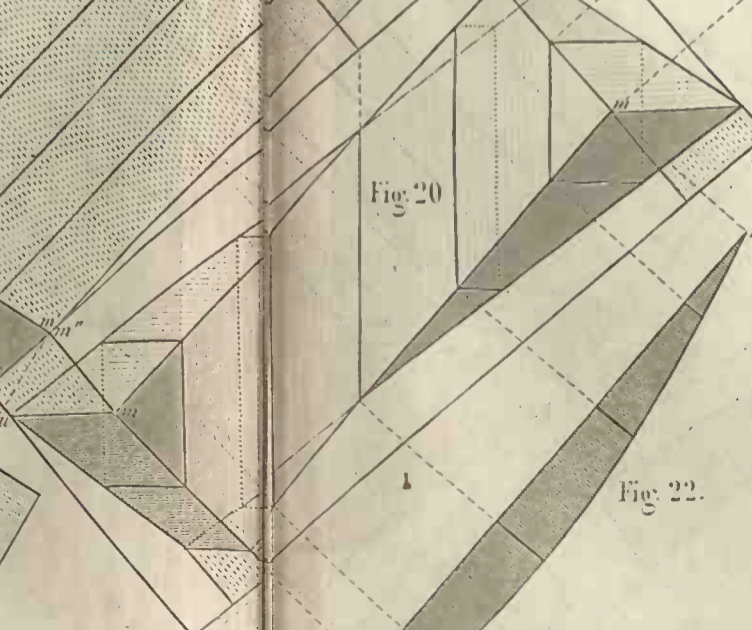


Fig. 22.

Fig. 26.

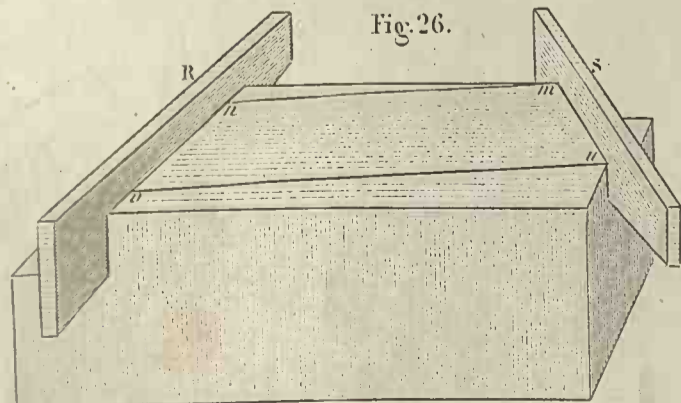


Fig. 27.

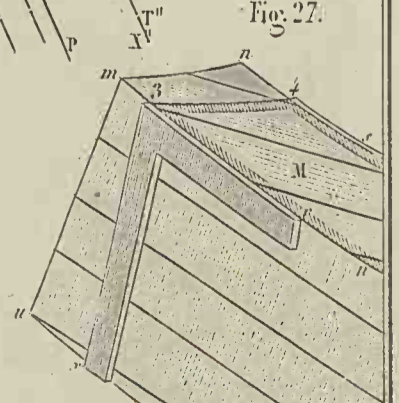


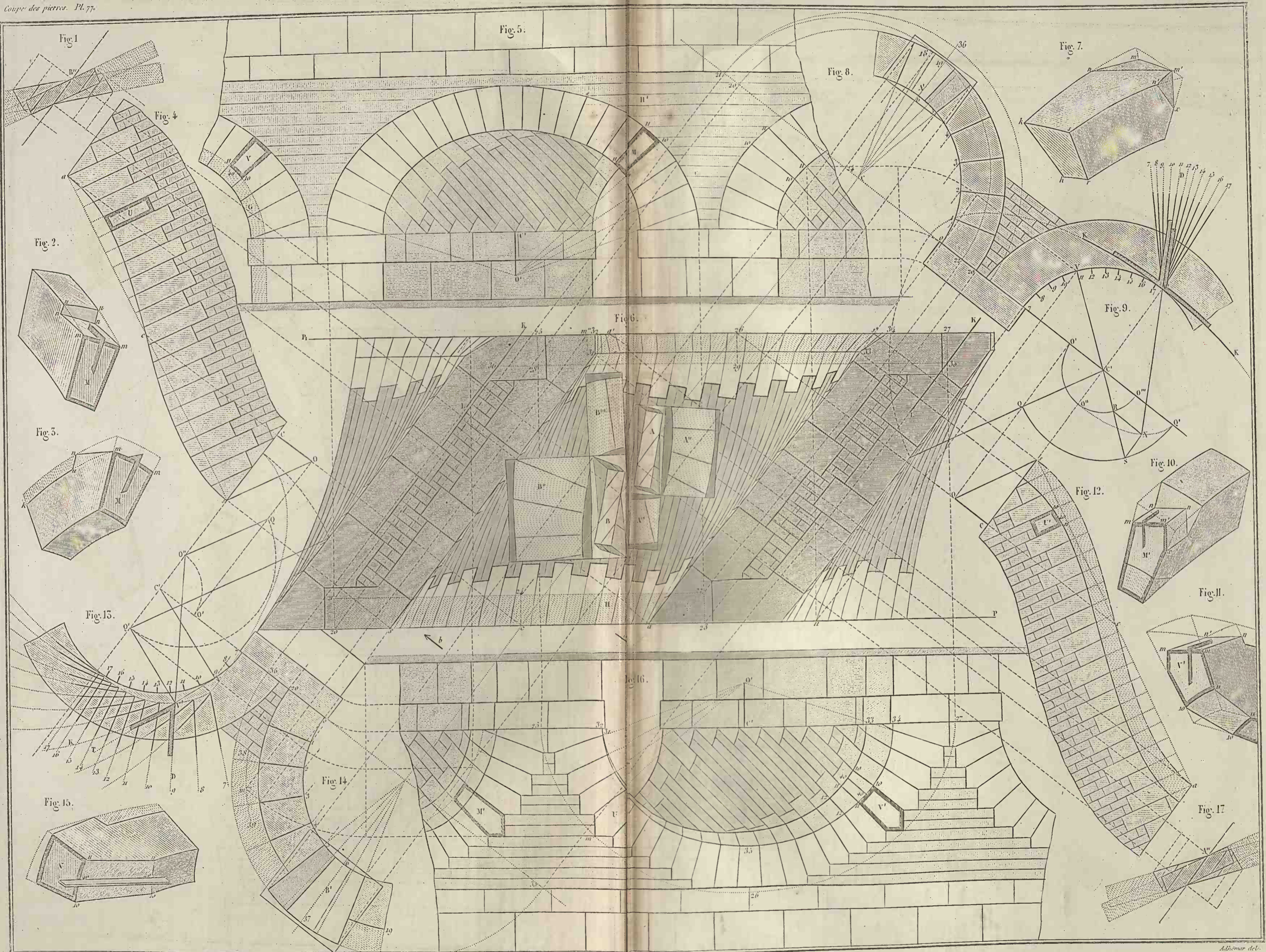
Fig. 28.

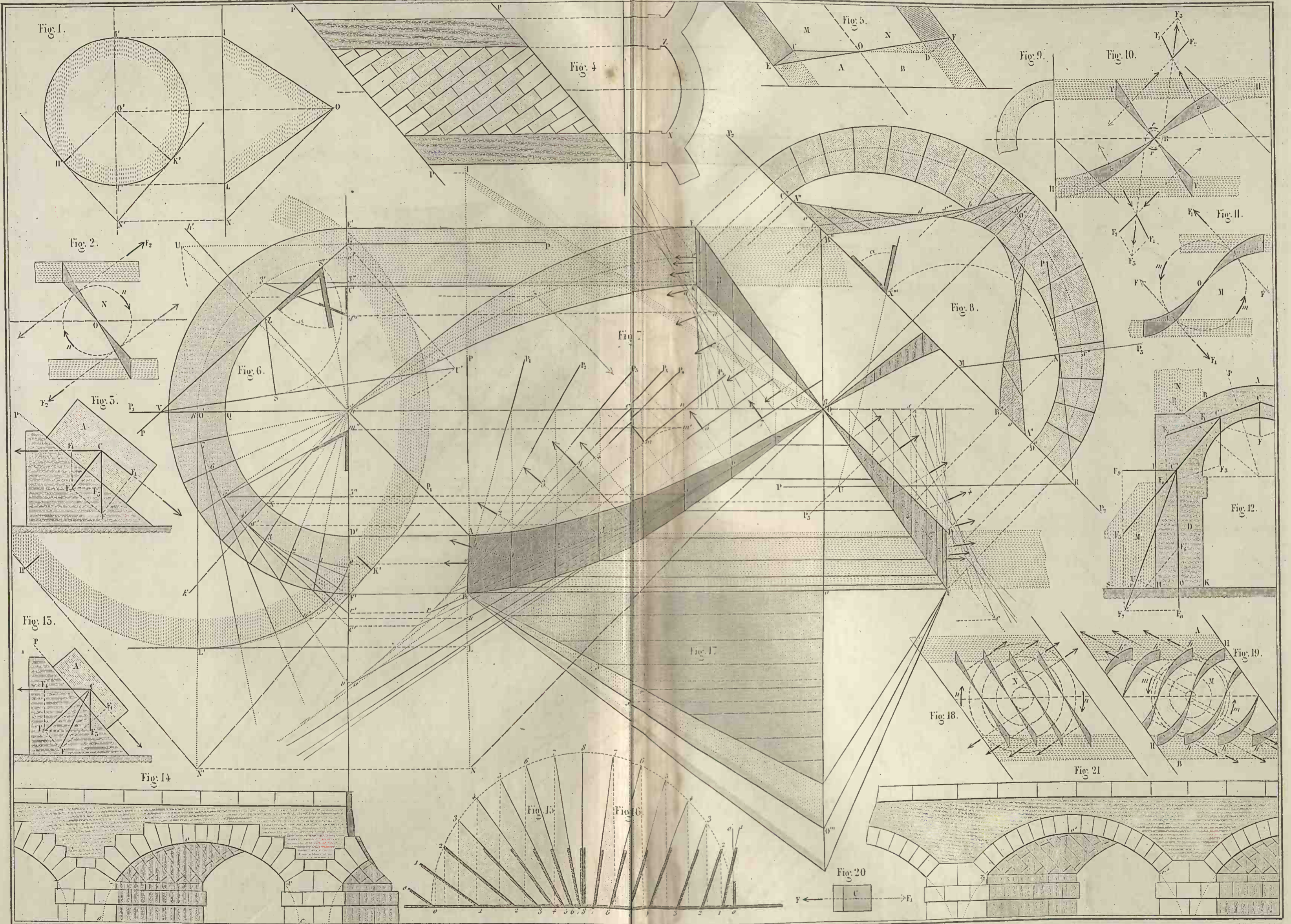


Fig. 29.



Coupe des pierres. Pl. 77.





Coupe des pierres. Pl. 79.

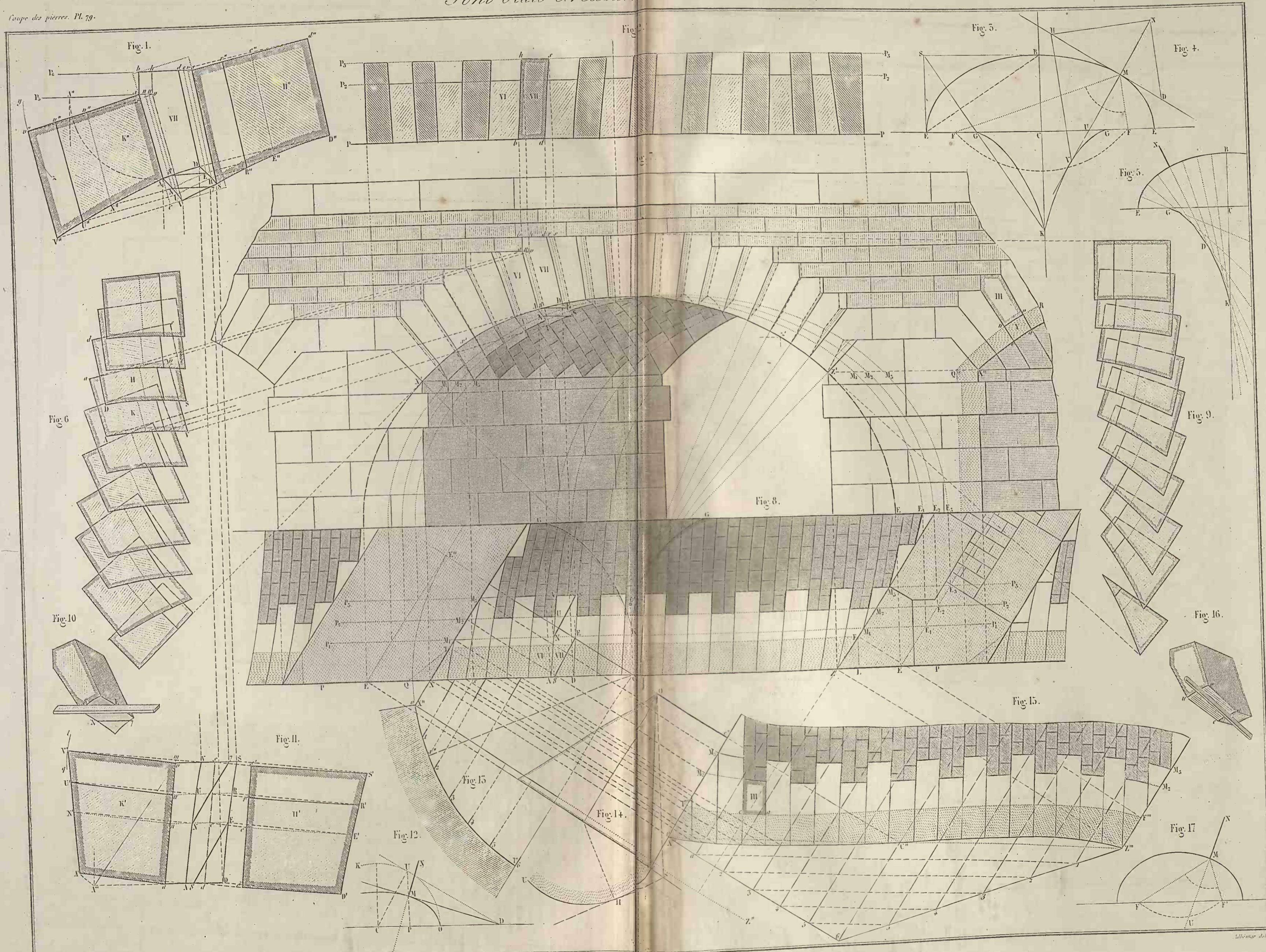


Fig. 1.

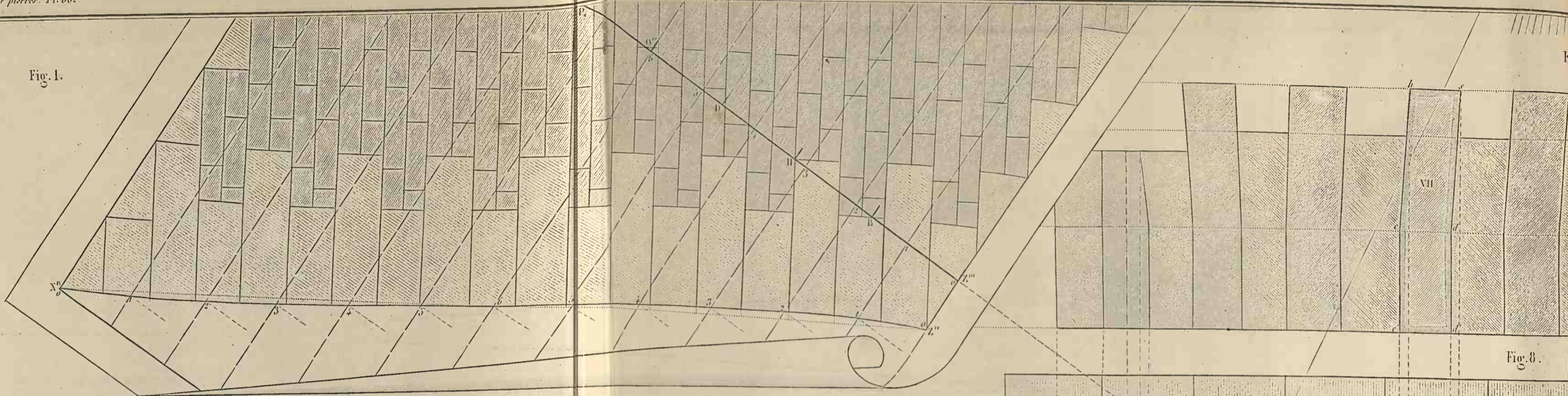


Fig. 4.

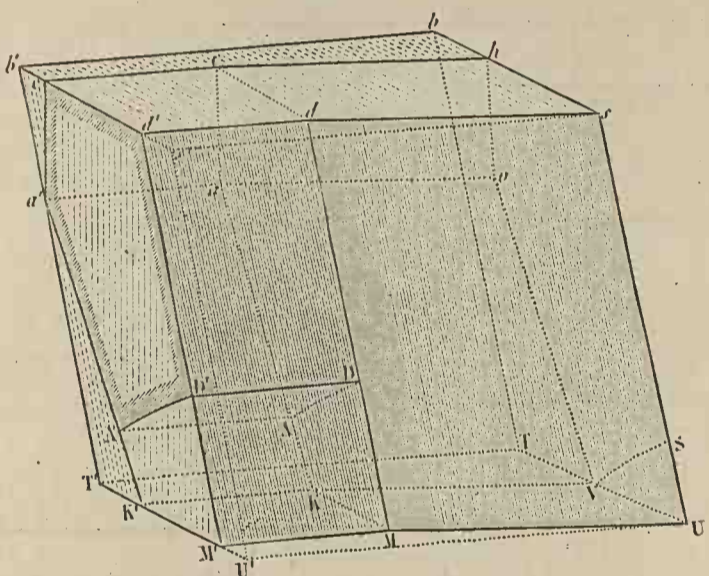


Fig. 5.

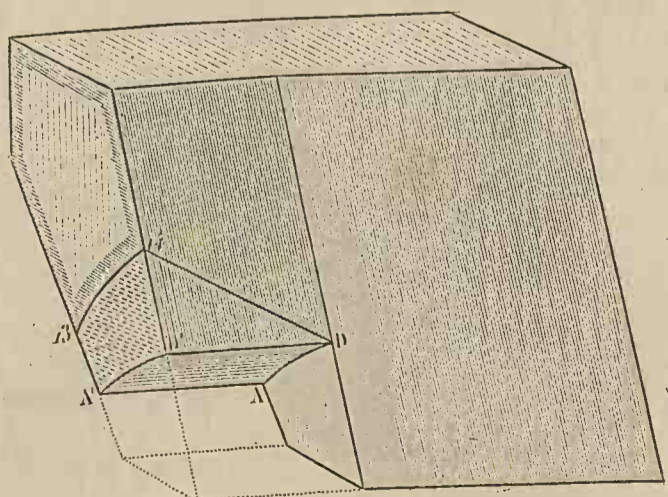


Fig. 6.

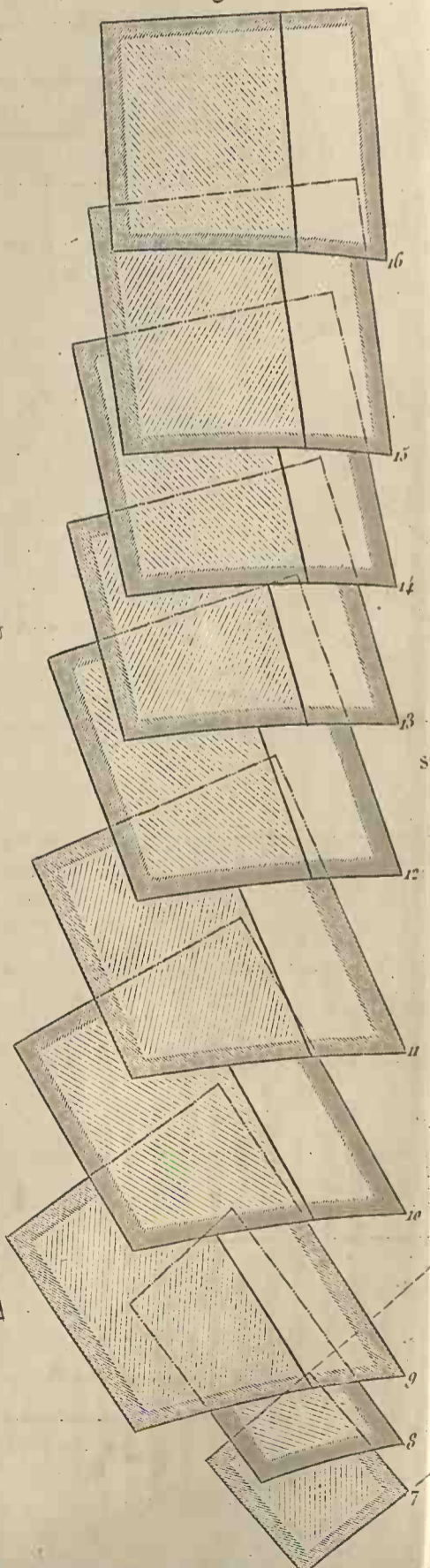


Fig. 7.

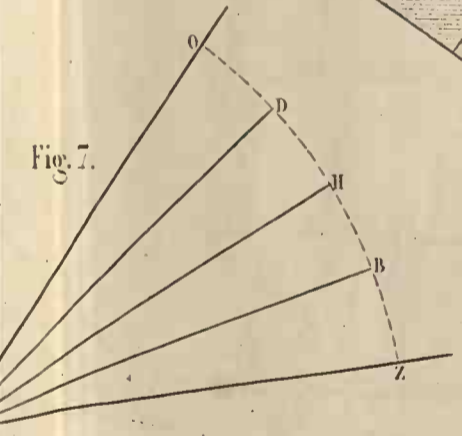
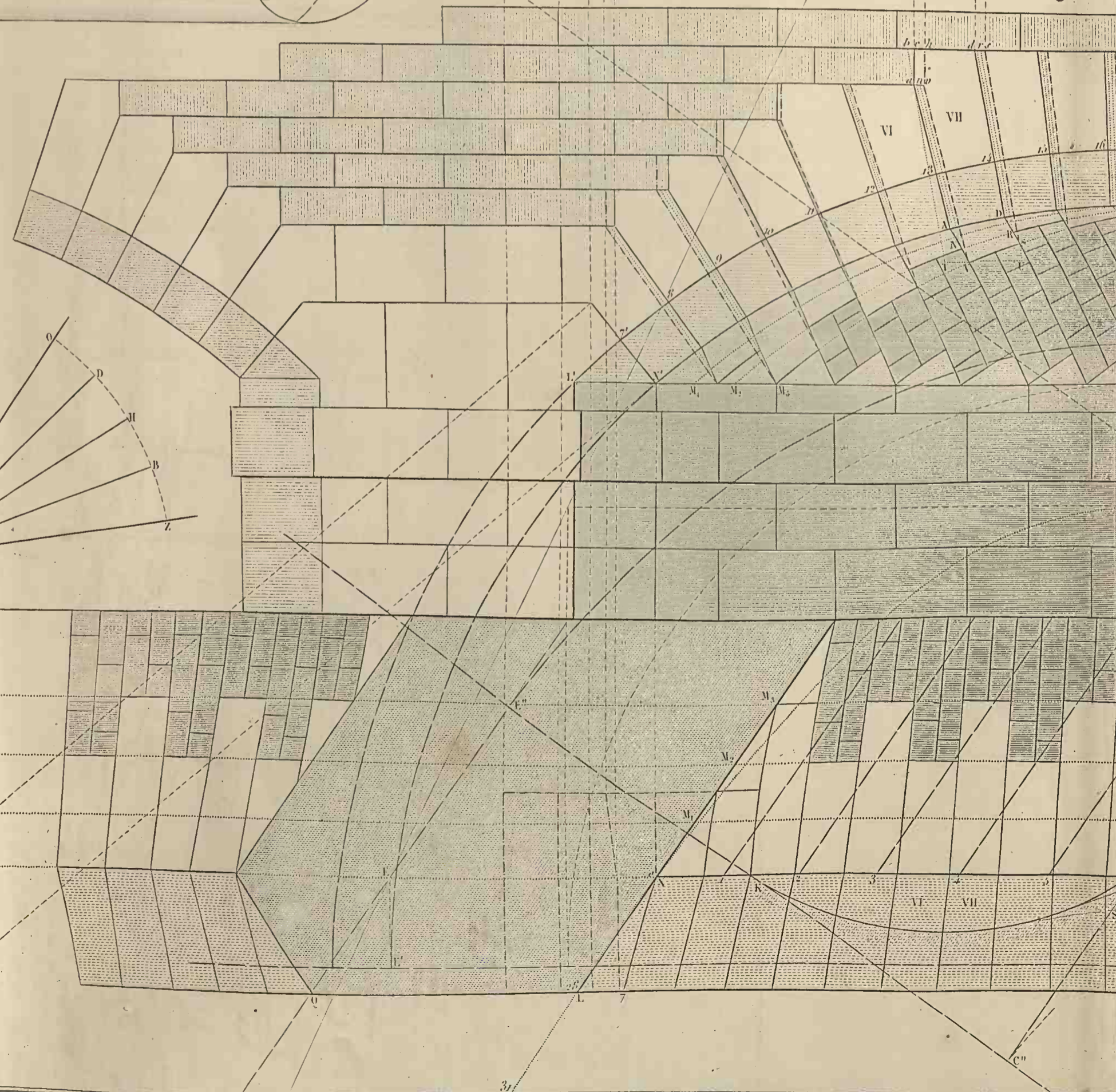


Fig. 8.



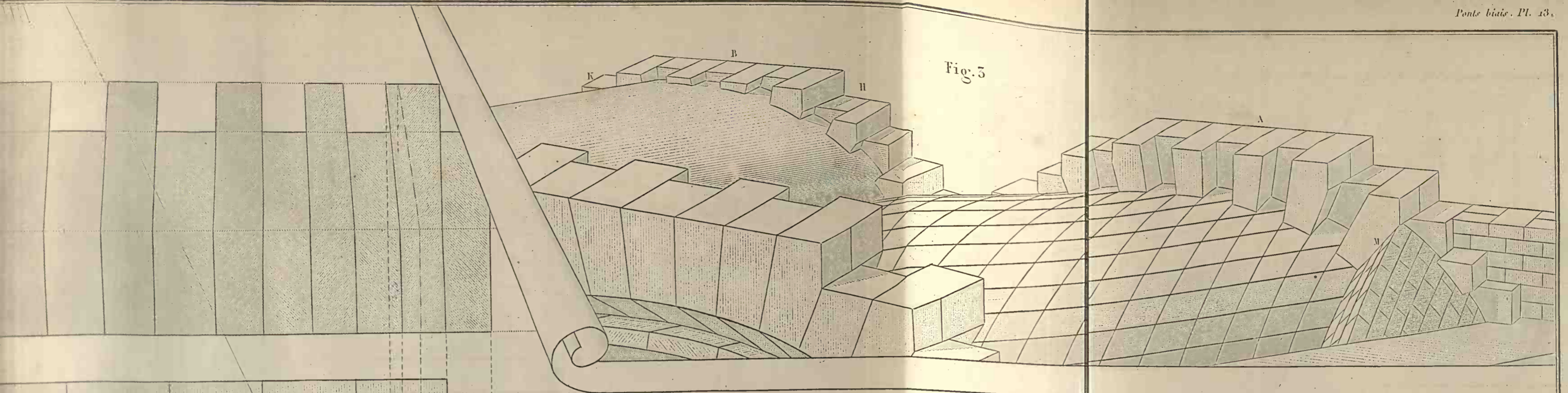


Fig. 5

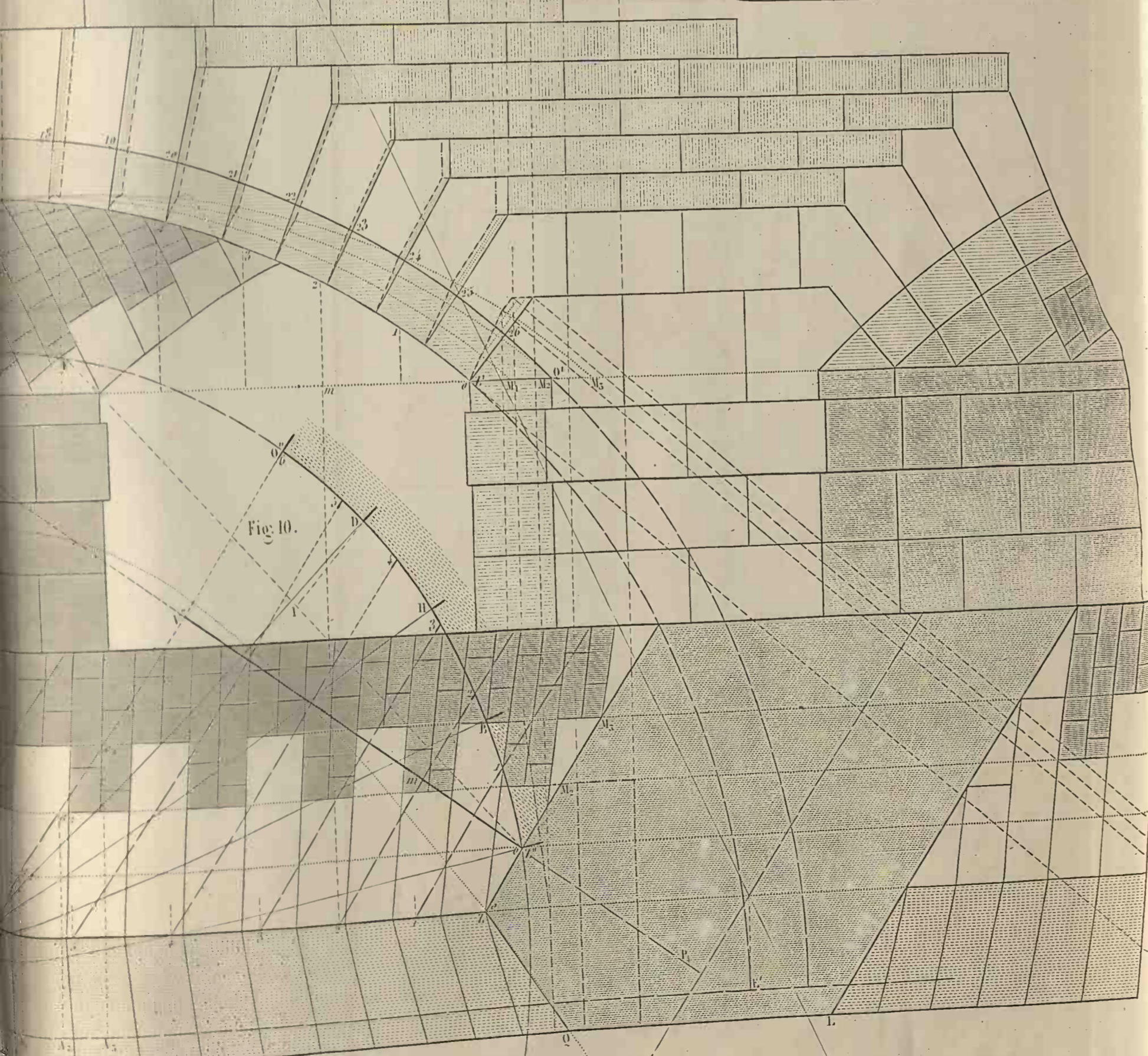


Fig. 10.

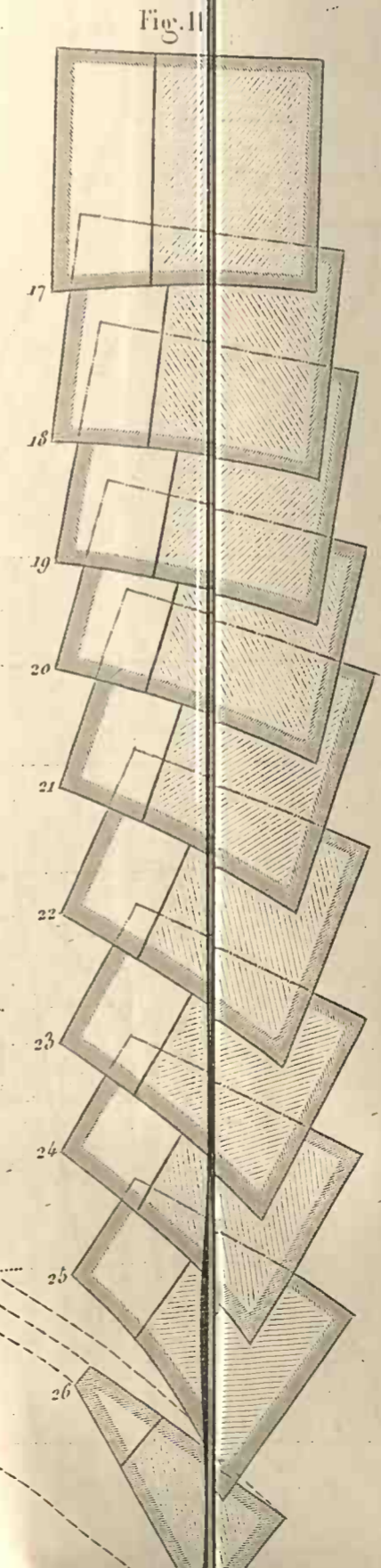


Fig. 11

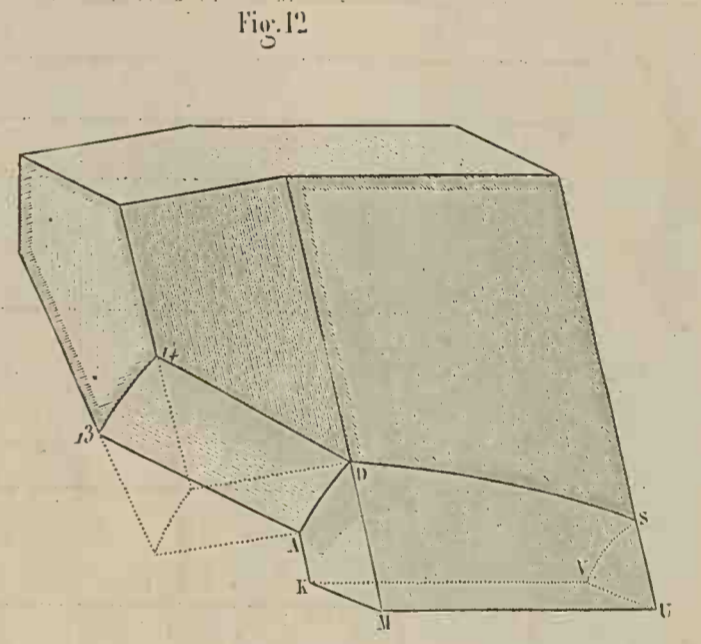


Fig. 12

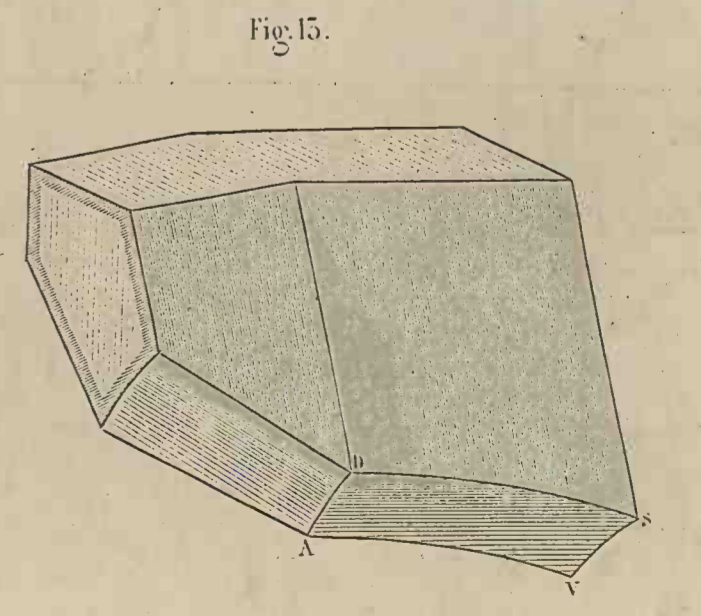


Fig. 15.

Ponts biais - appareil orthogonal

Fig. 1

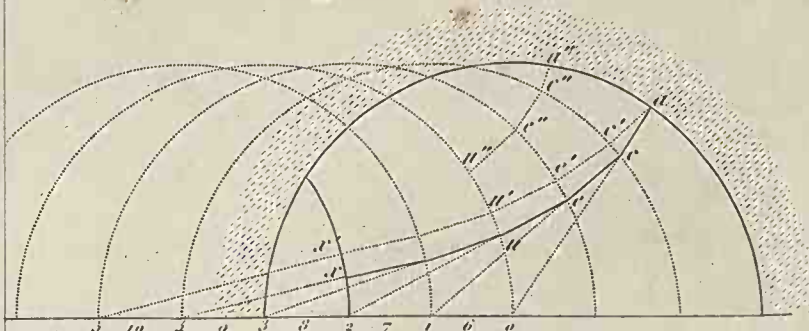


Fig. 2

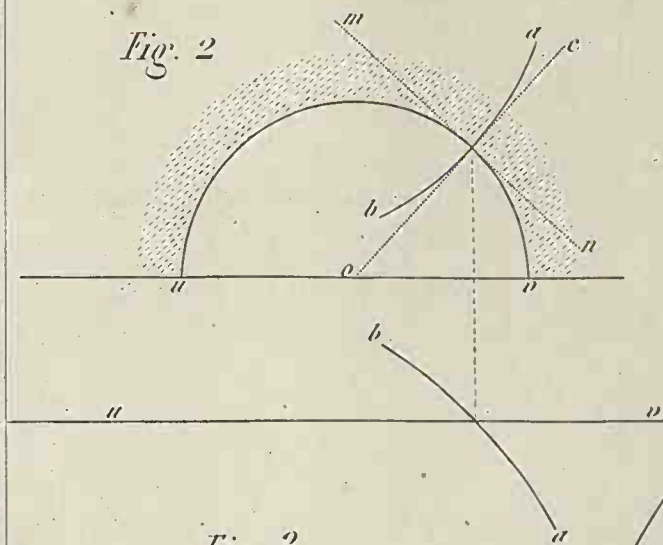


Fig. 3

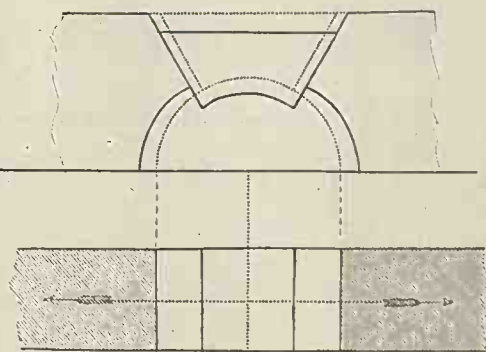


Fig. 4

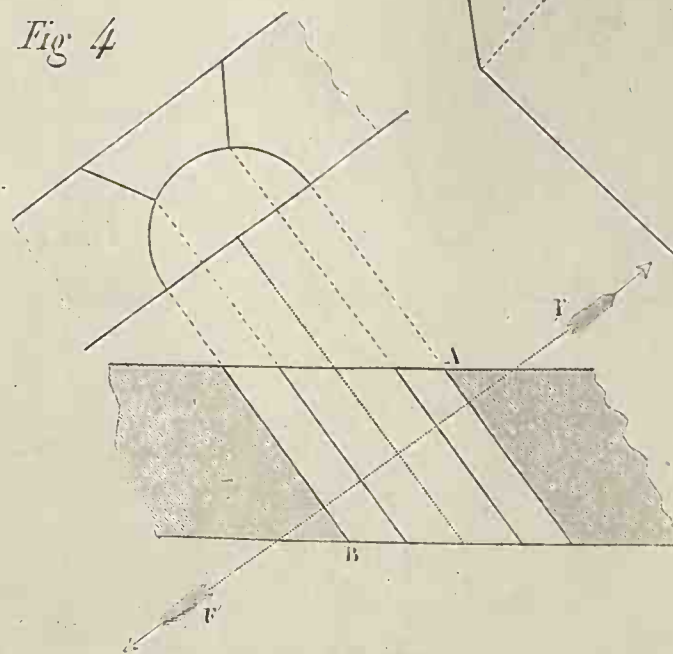


Fig. 5

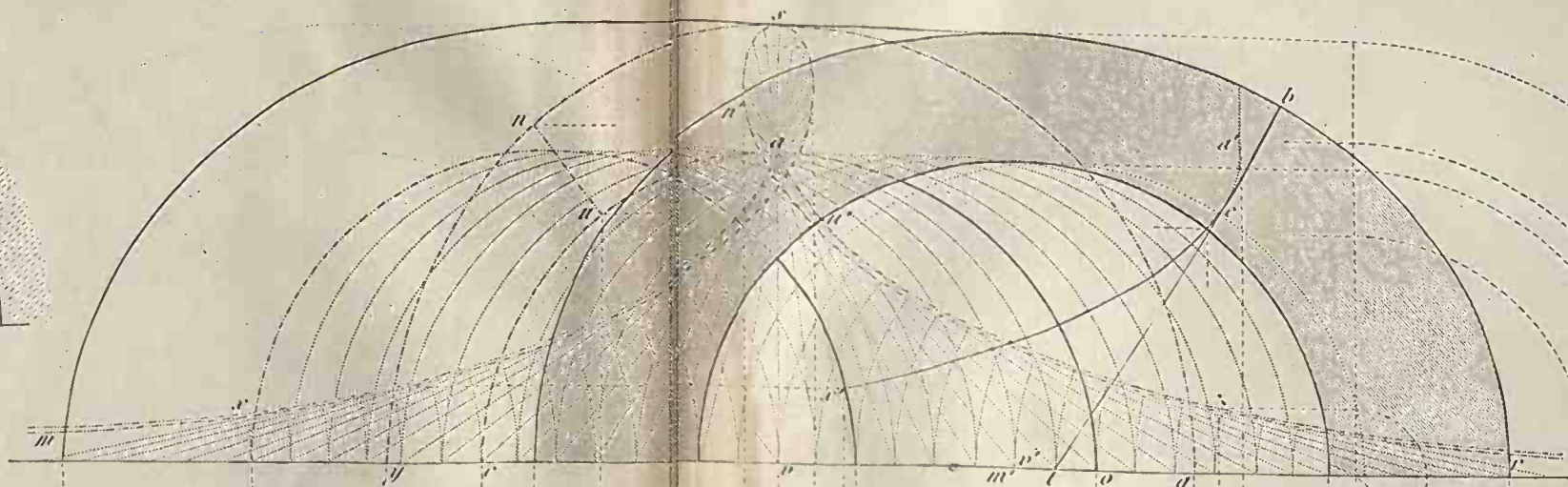


Fig. 6

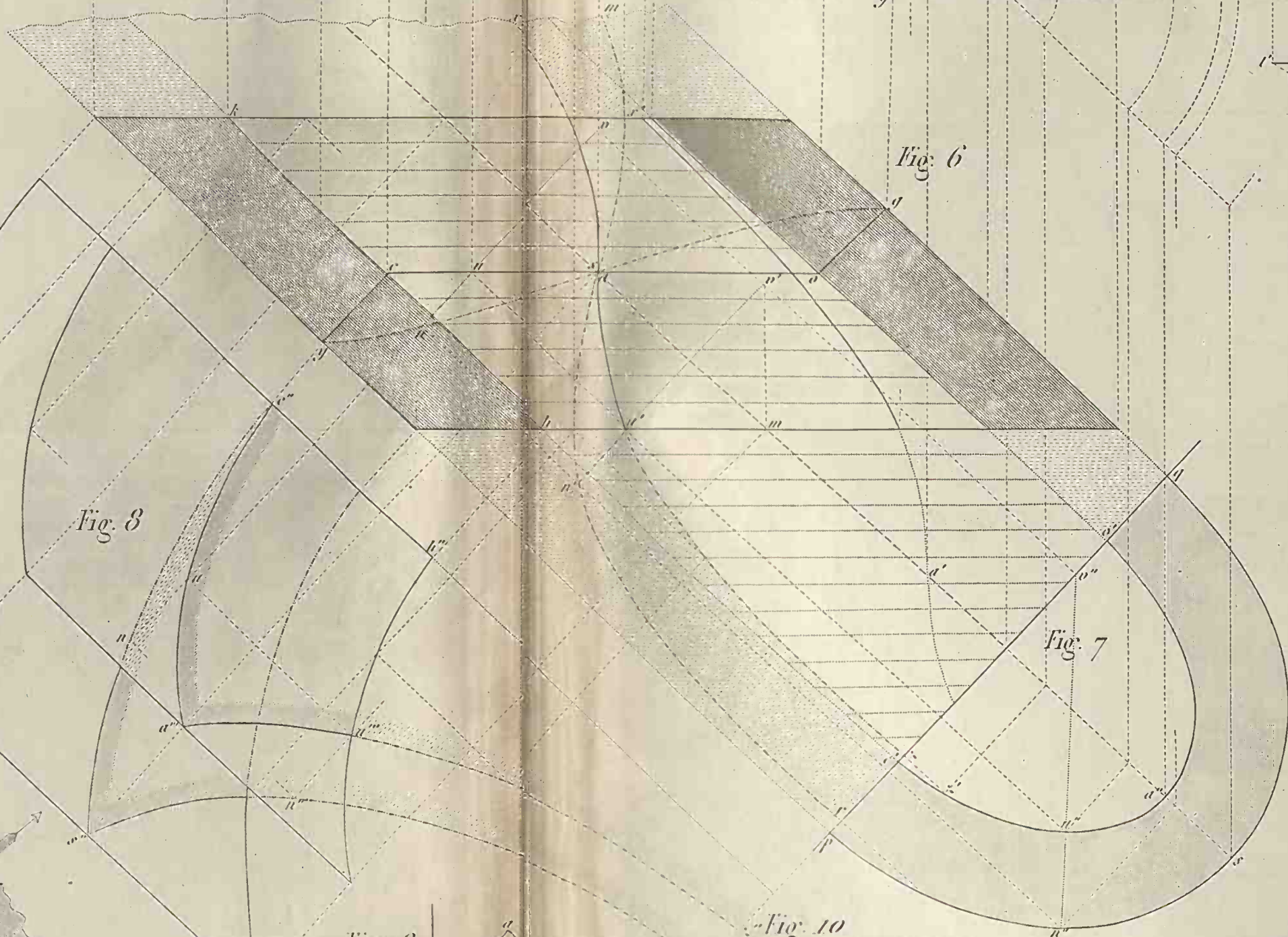


Fig. 8

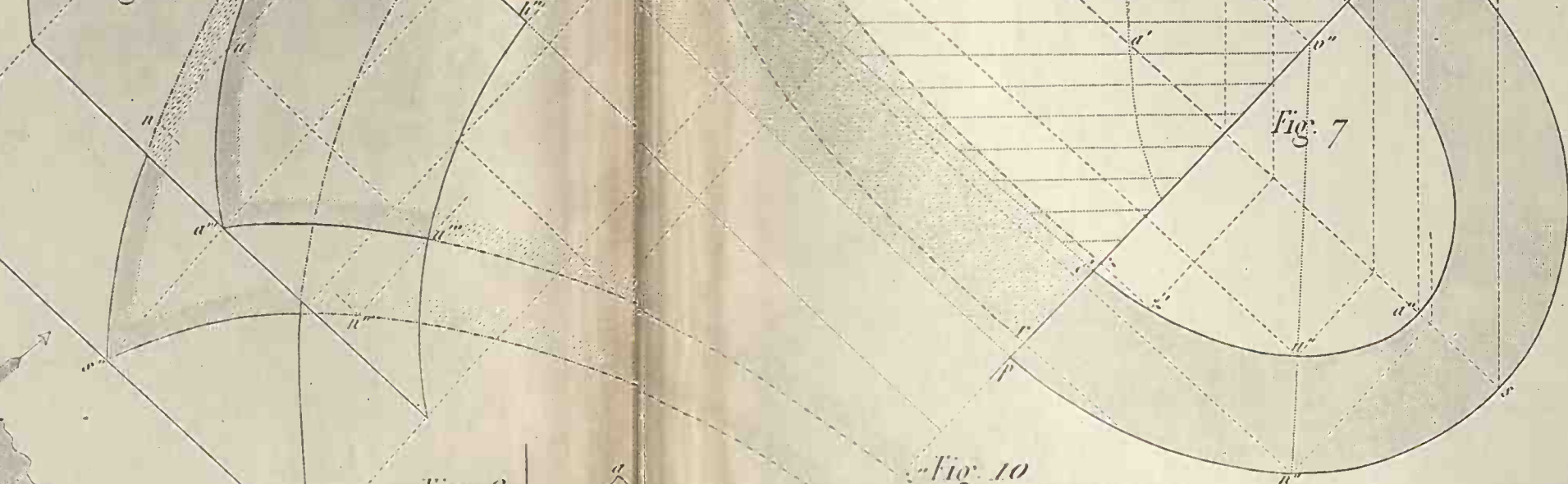


Fig. 7

Fig. 10

Fig. 9

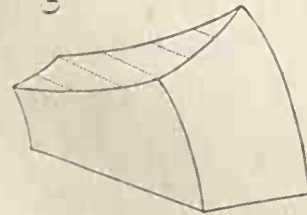
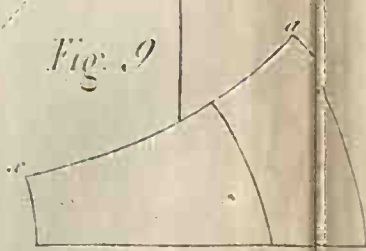


Fig. 11

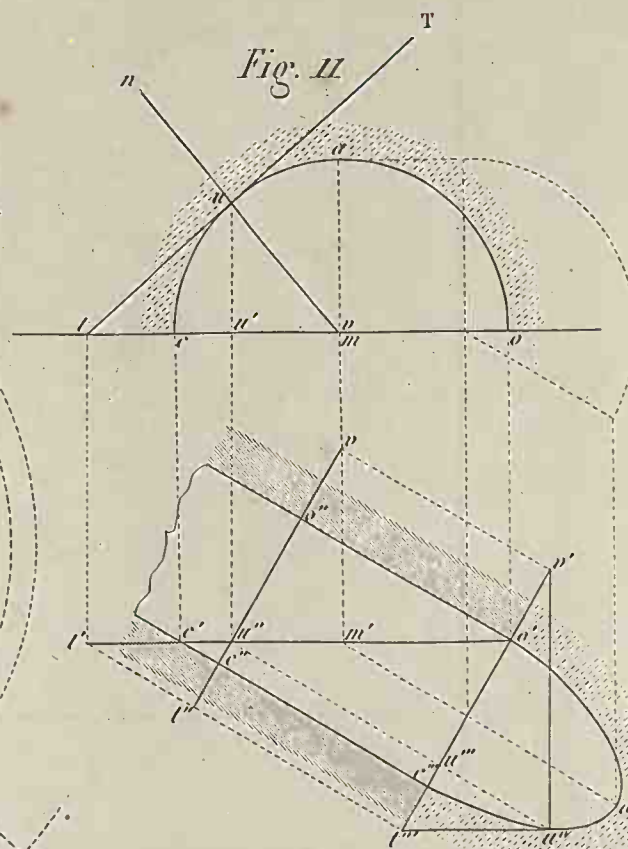


Fig. 12

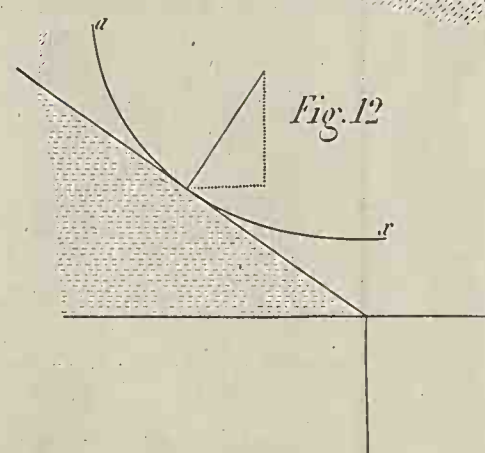


Fig. 13

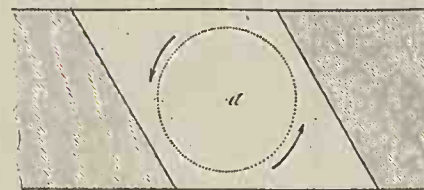
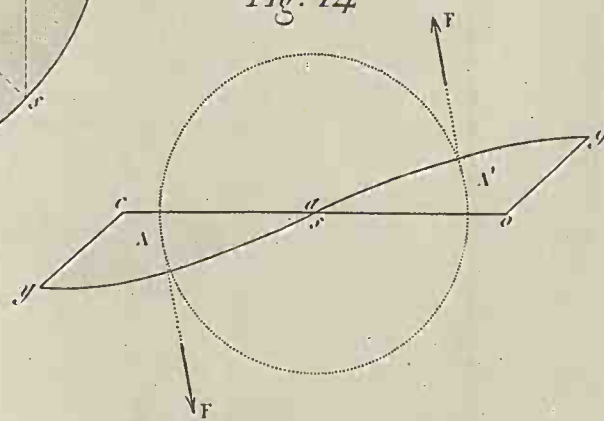


Fig. 14



Ponts biais - appareil orthogonal - Joints Plans

Fig. 1

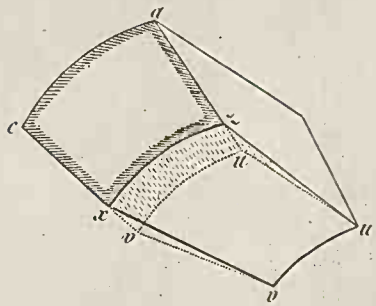


Fig. 2

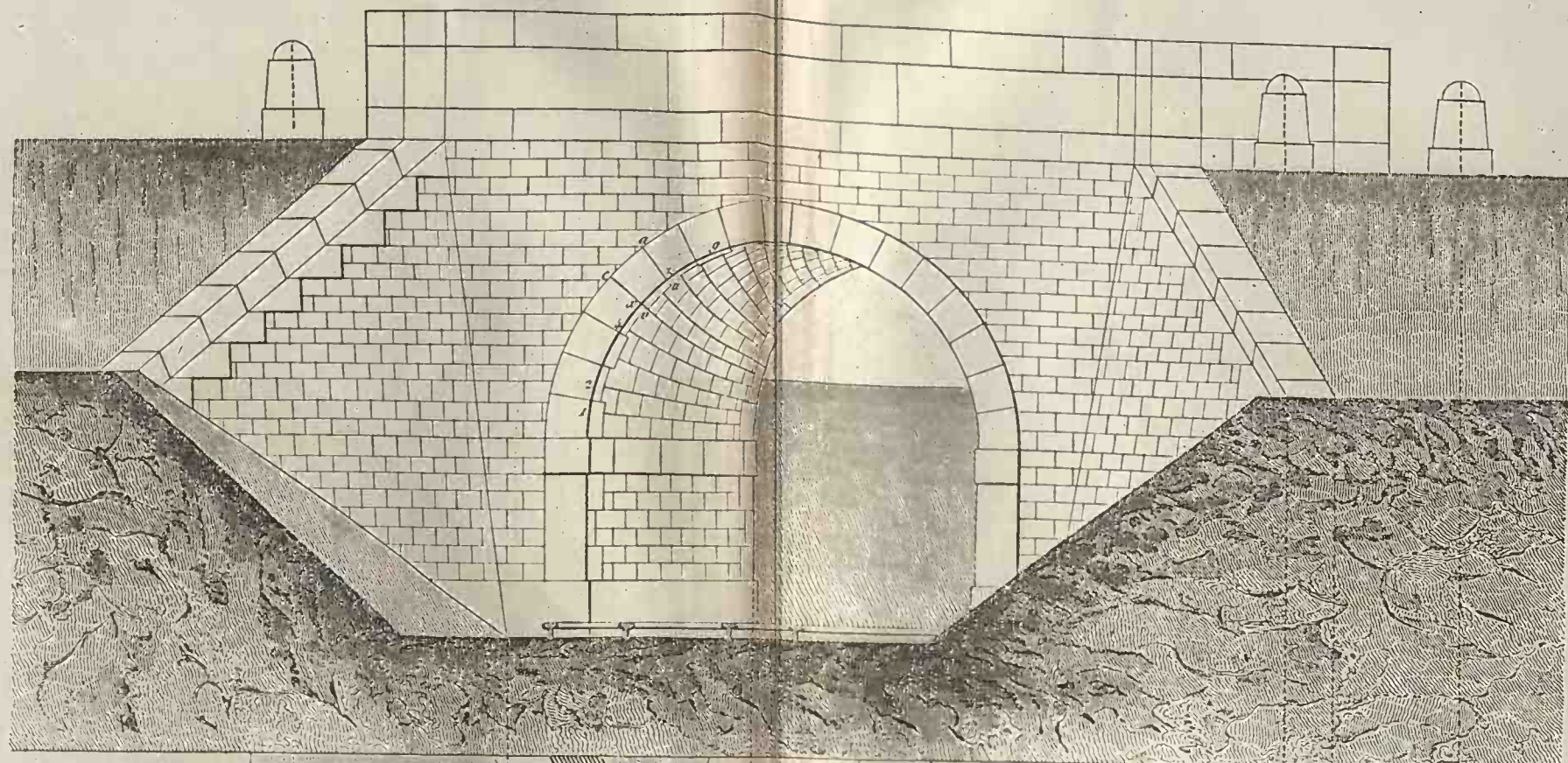


Fig. 3

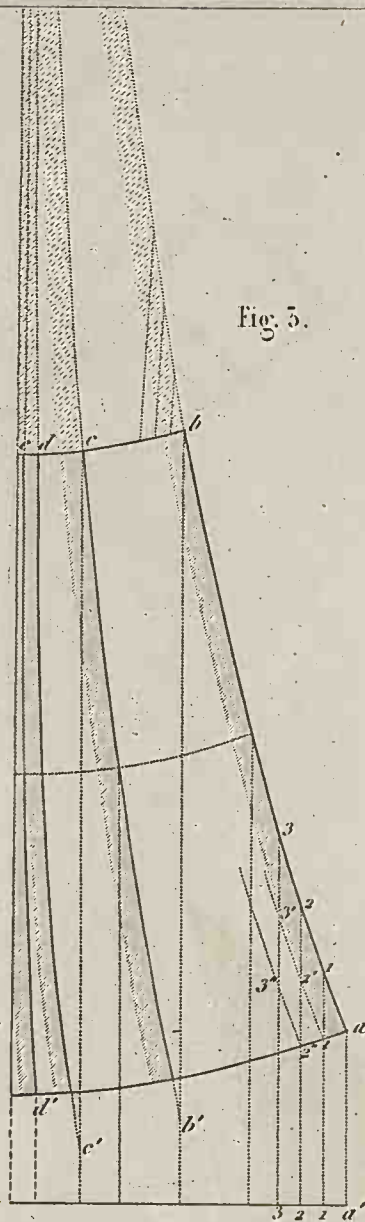


Fig. 4

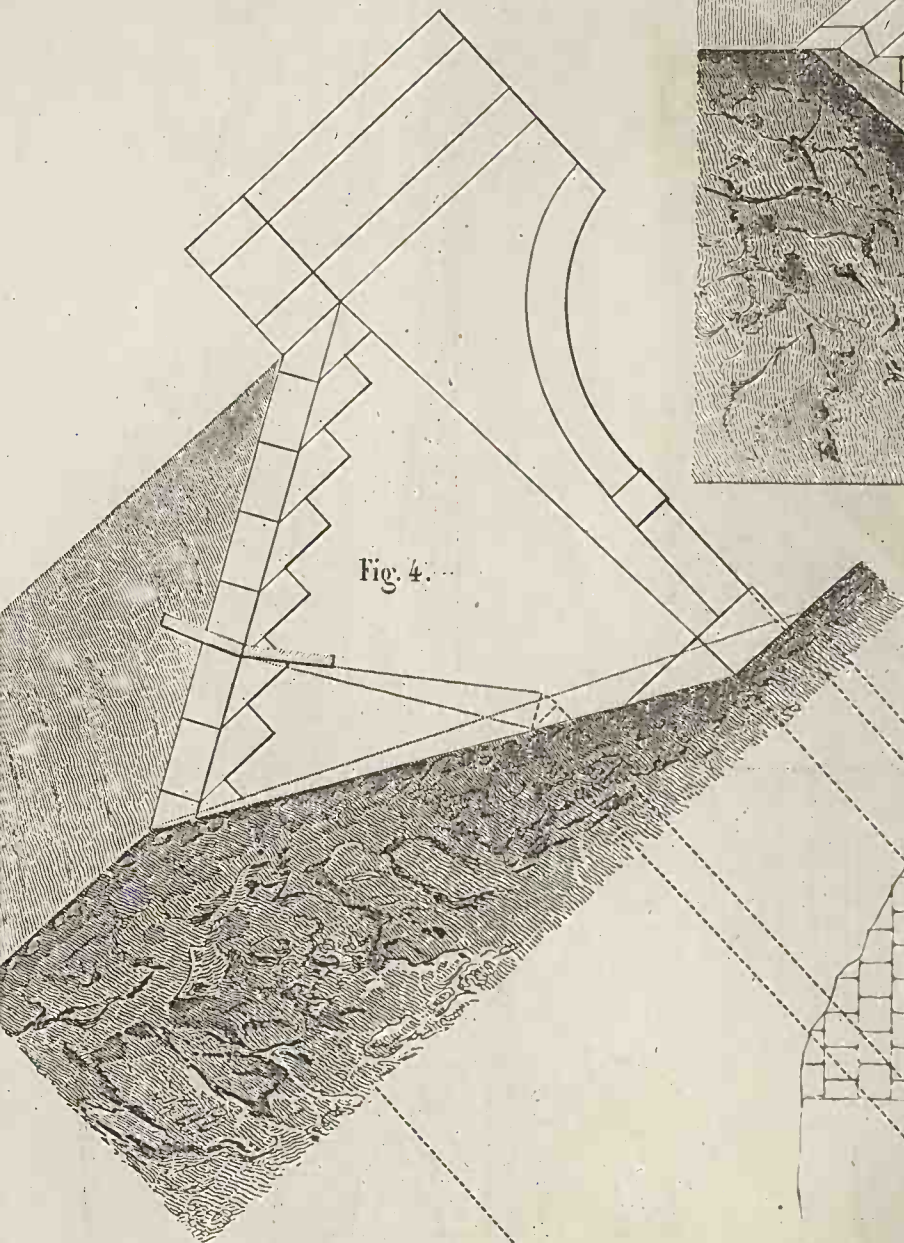


Fig. 6

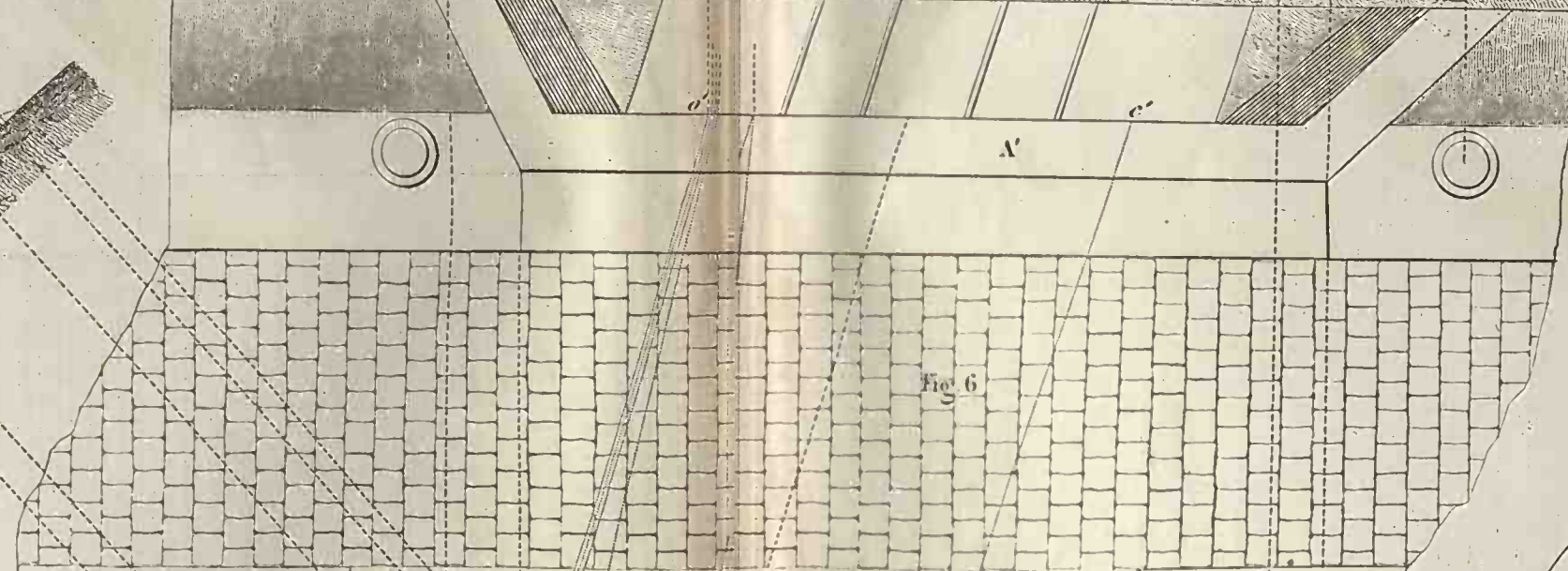


Fig. 7

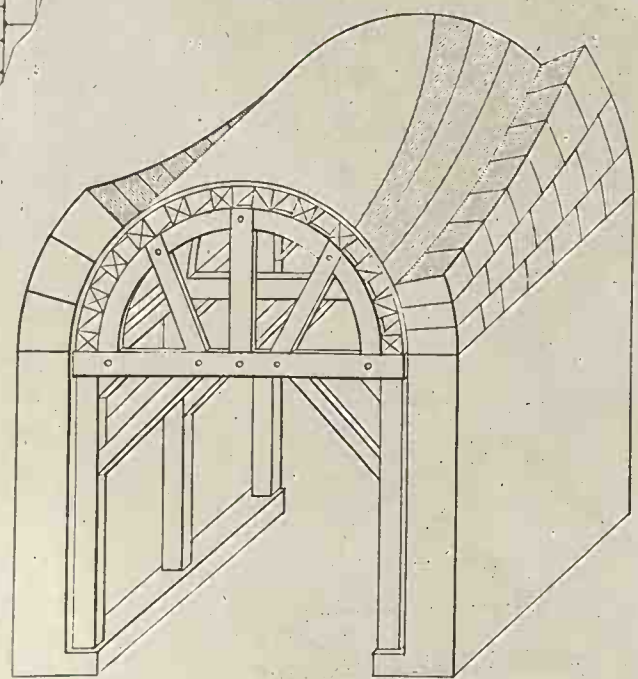


Fig. 5

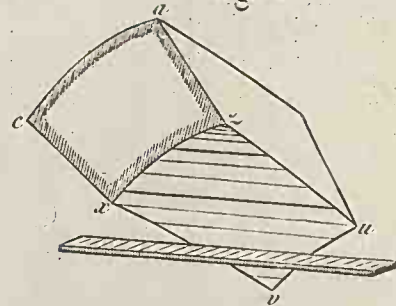


Fig. 1.

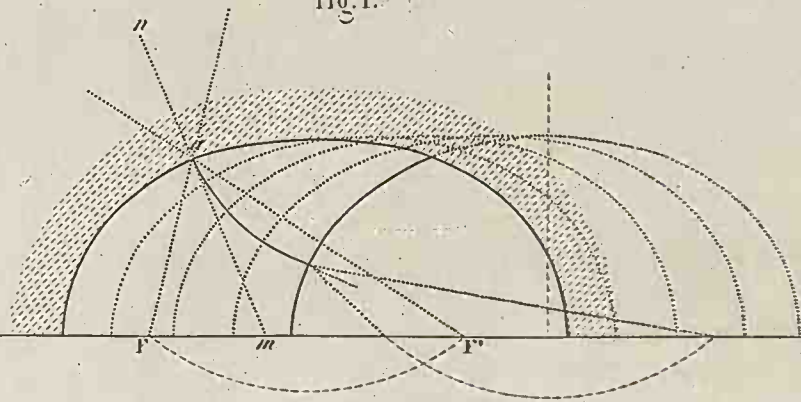


Fig. 2.

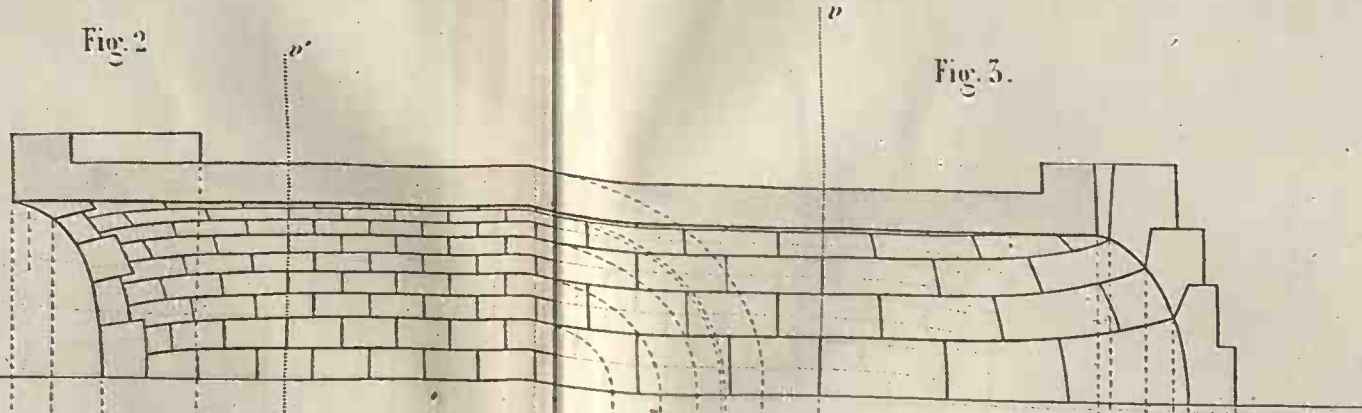


Fig. 3.

Fig. 4.

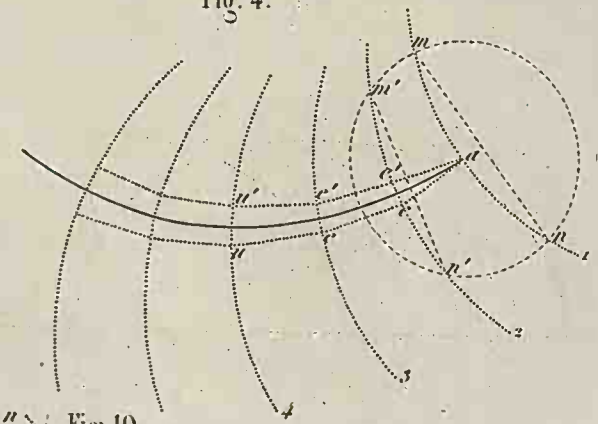


Fig. 5.

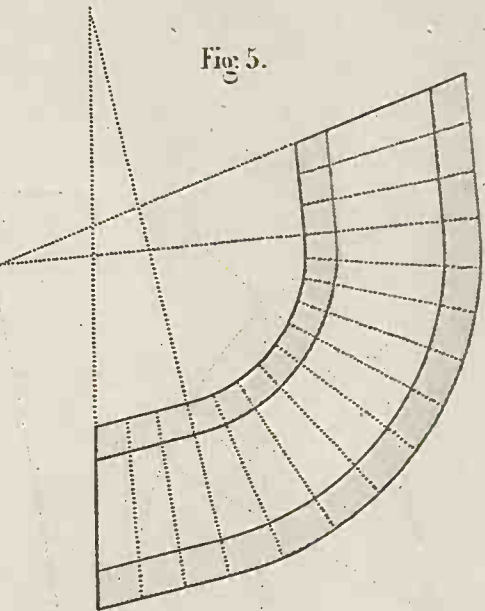


Fig. 7.

Fig. 8.

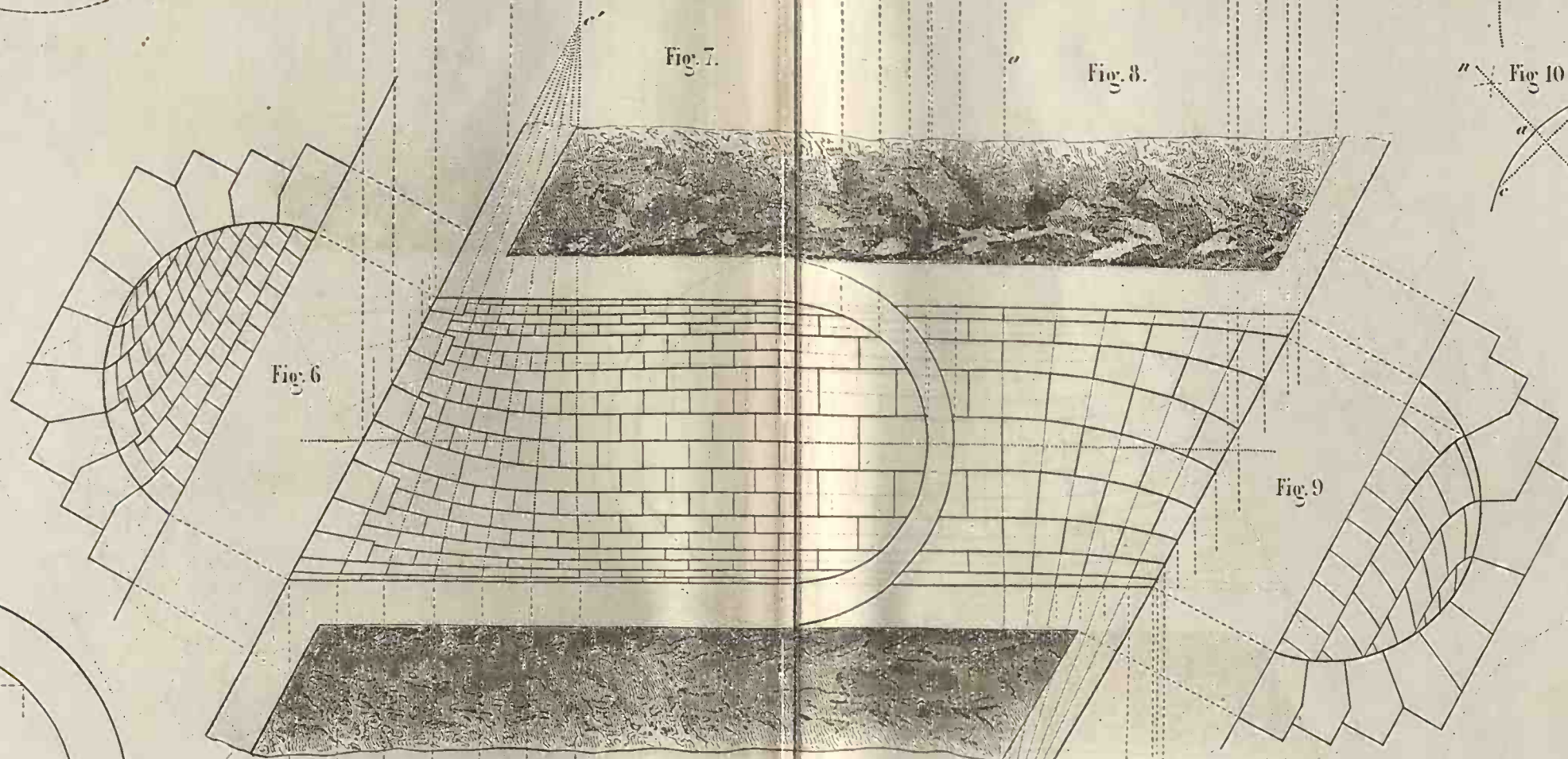


Fig. 10.

Fig. 11.

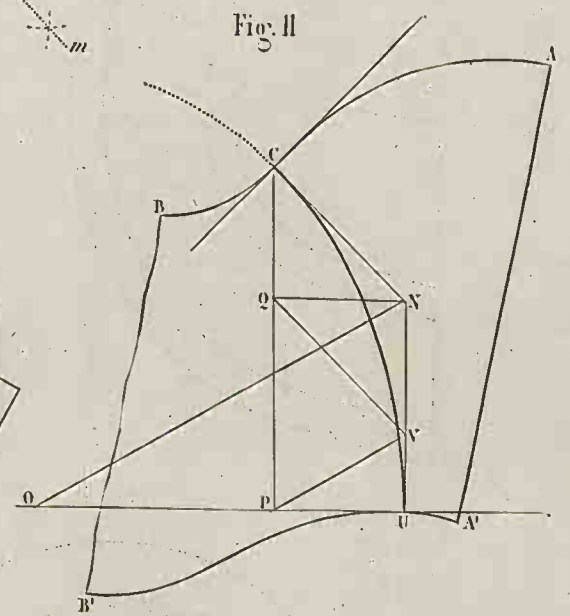


Fig. 12.

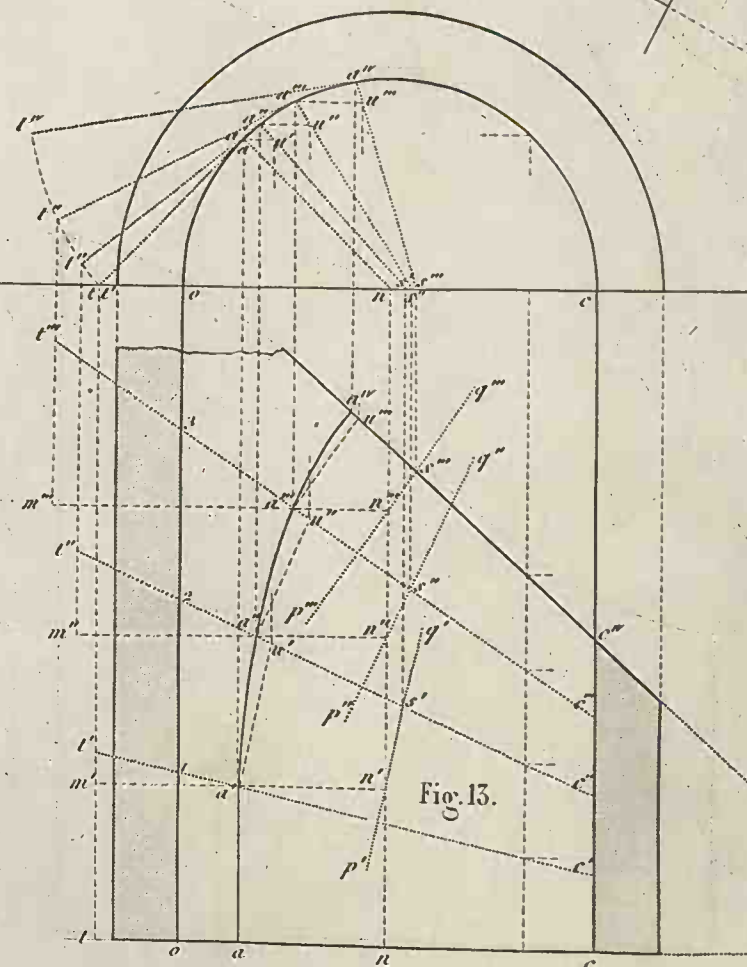


Fig. 14.

Fig. 15.

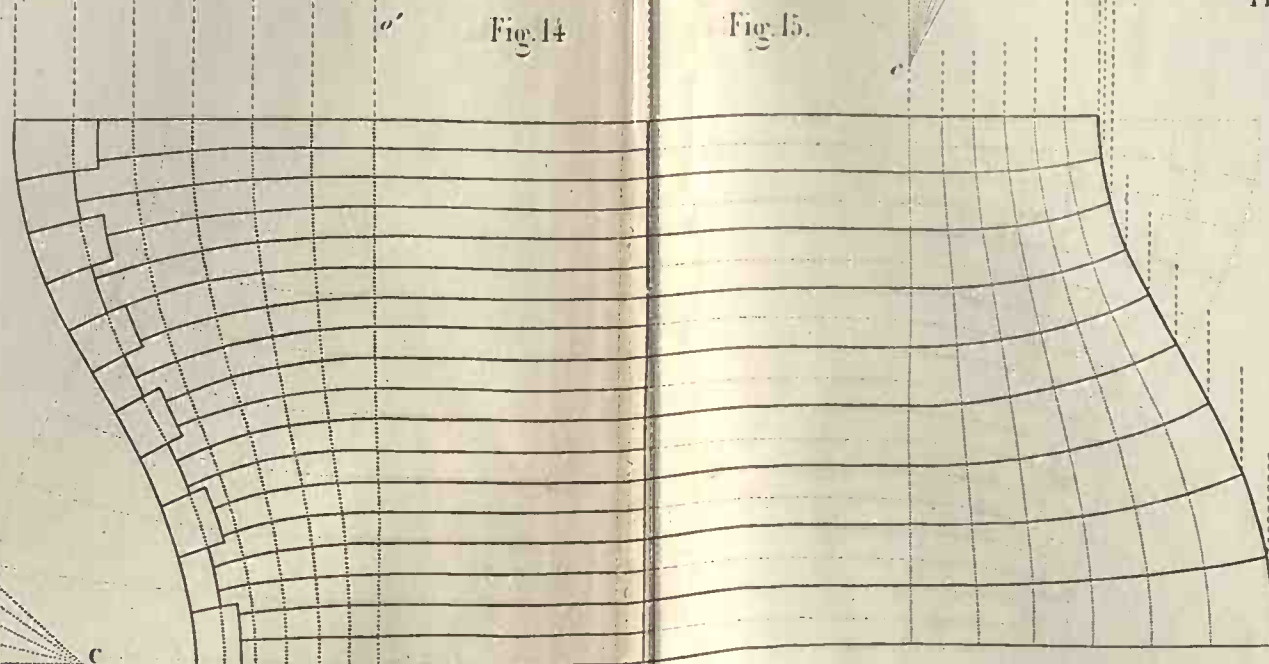


Fig. 16.

Fig. 17.

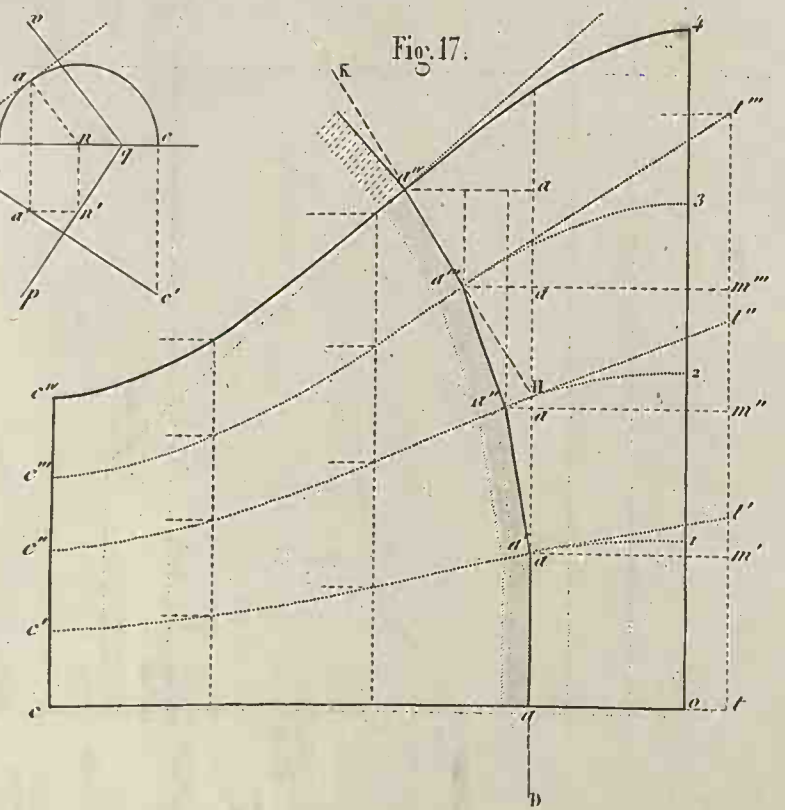
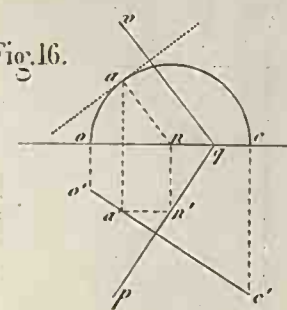


Fig. 1

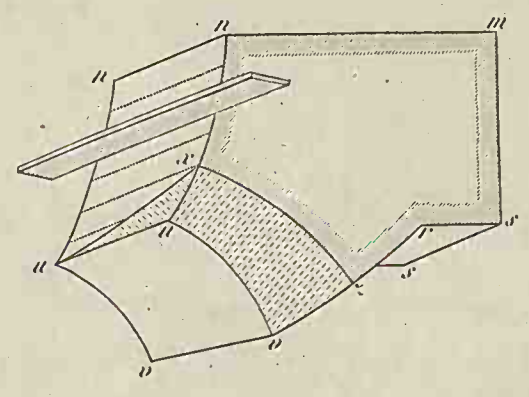


Fig. 2.

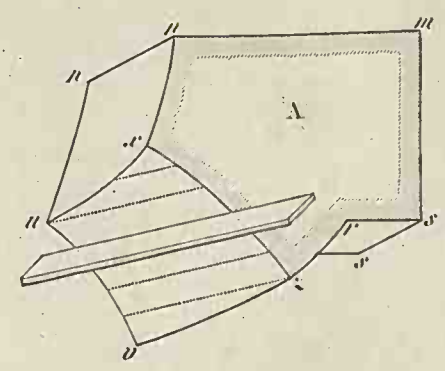


Fig 5

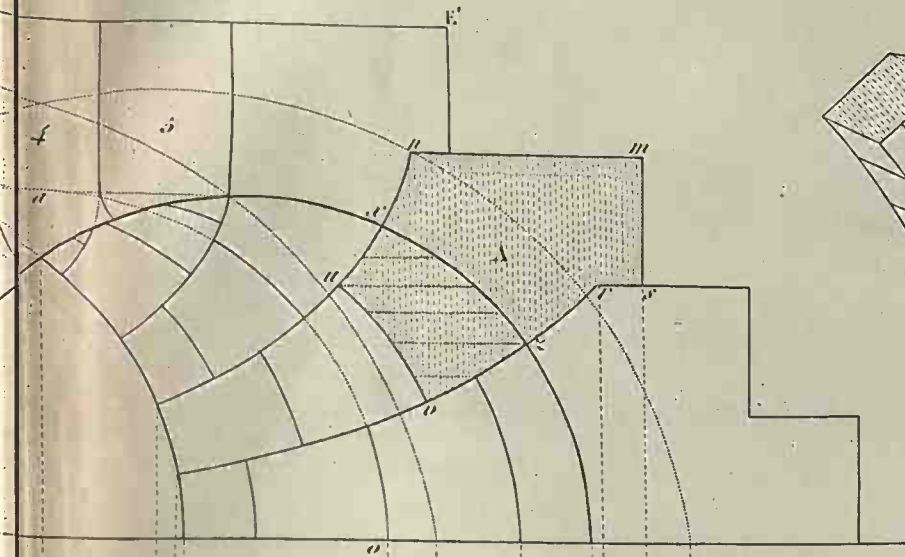


Fig. 4.

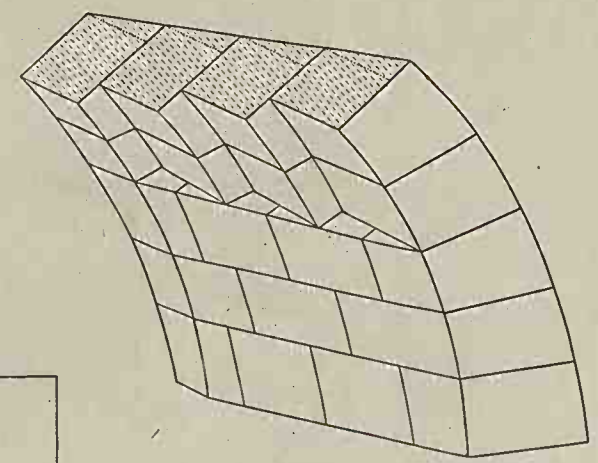


Fig 5.

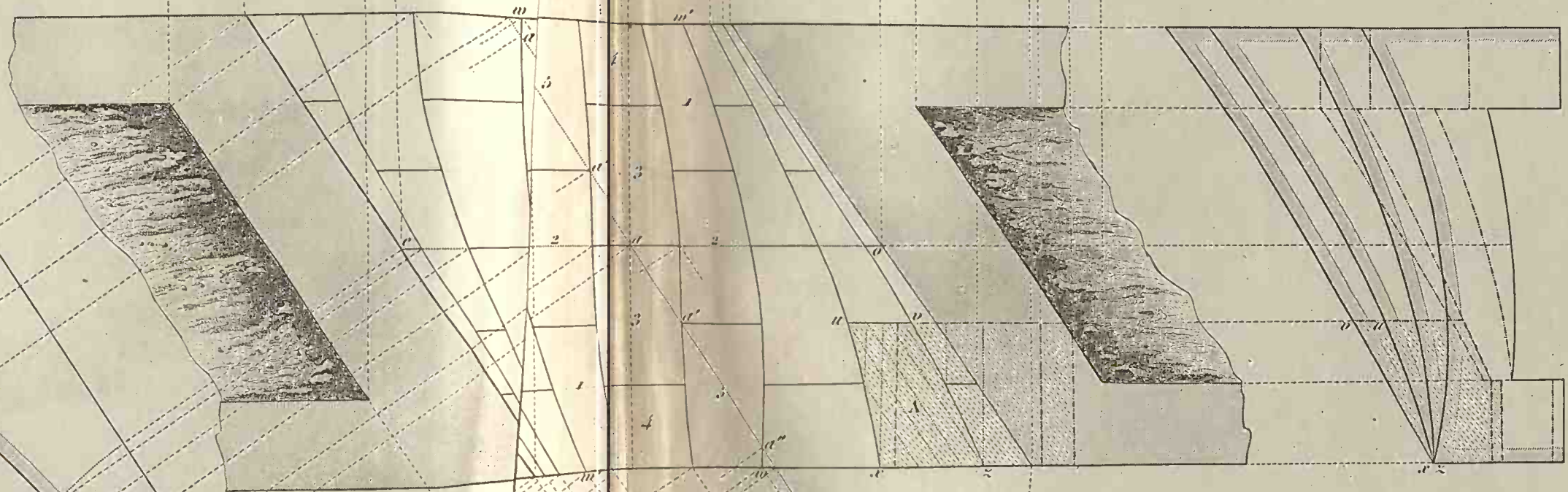


Fig 6.

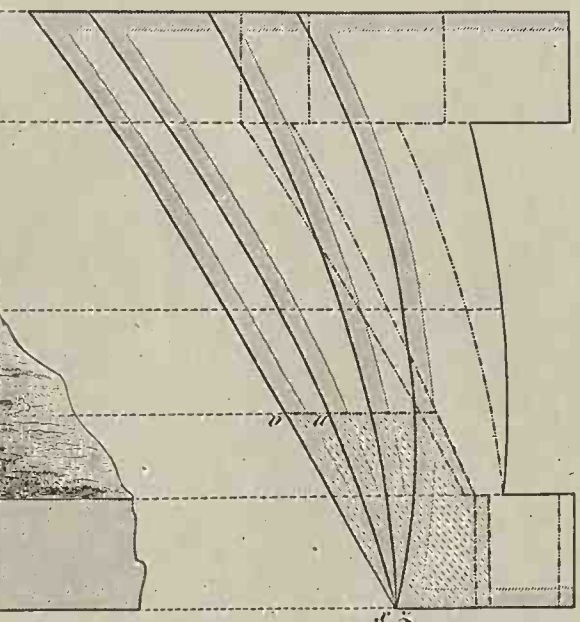


Fig. 9.

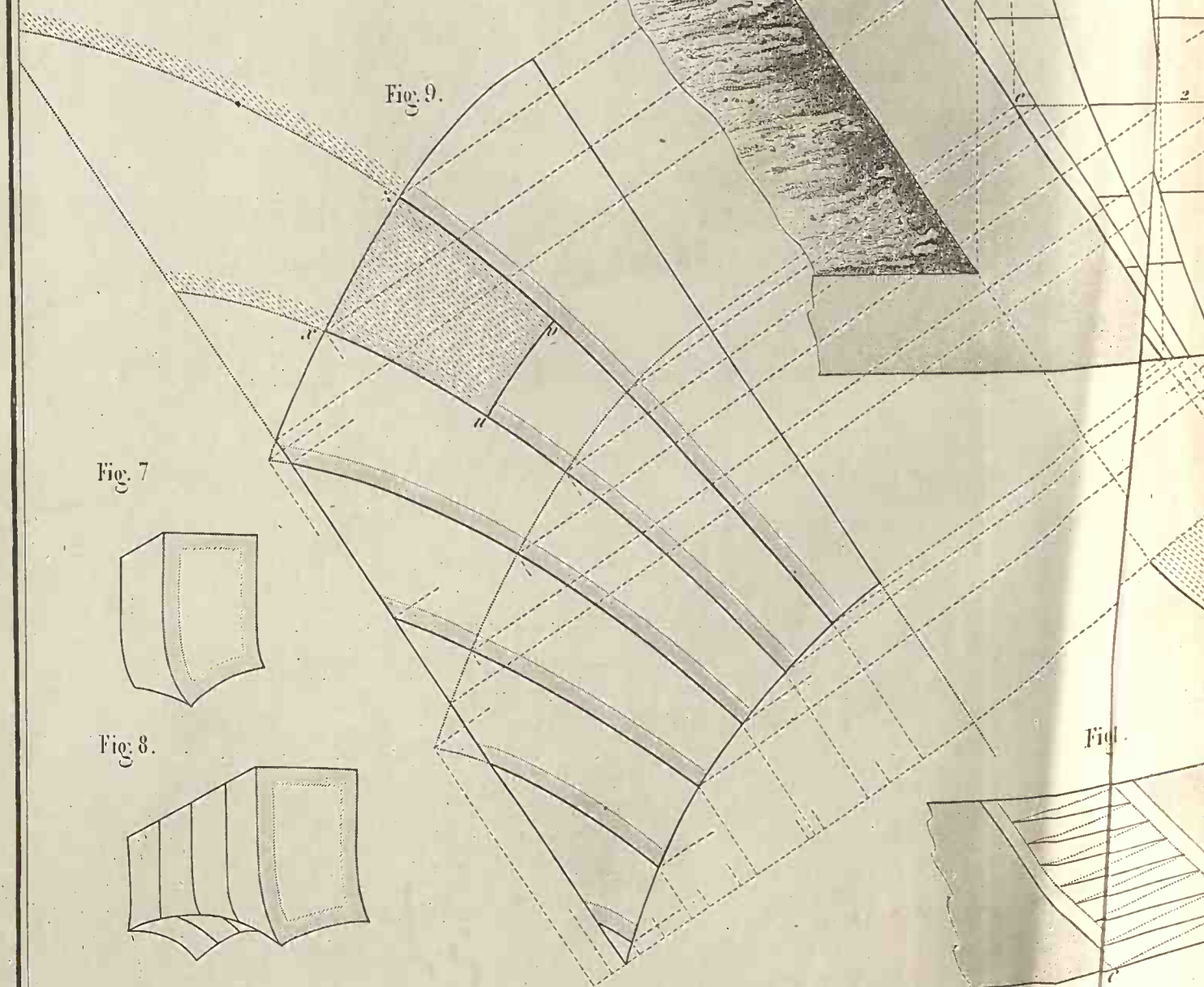


Fig. 7

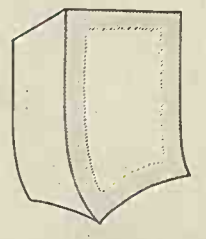


Fig. 8.

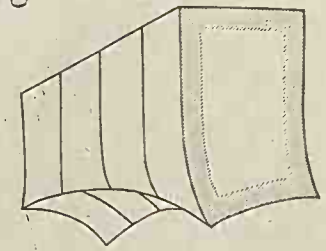


Fig. 10

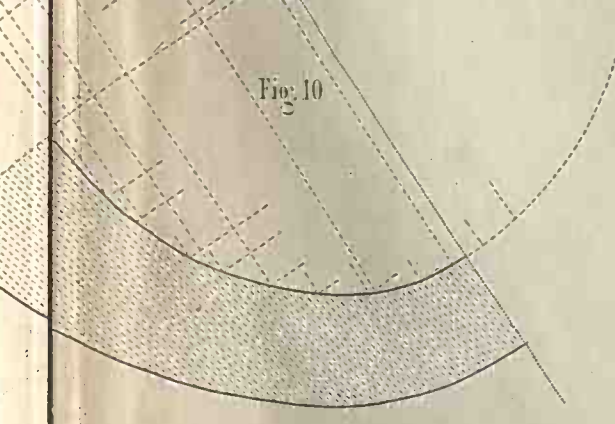


Fig. 15.

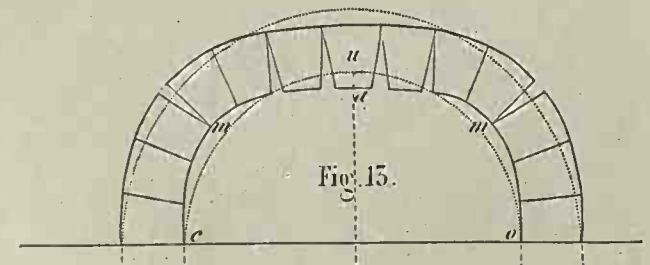


Fig.

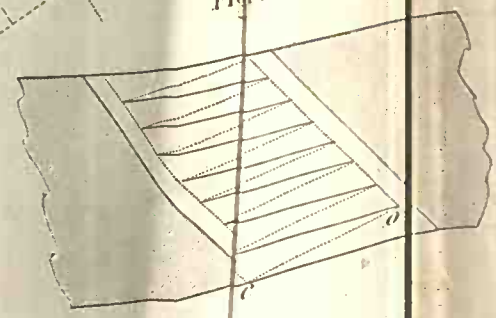


Fig. 12

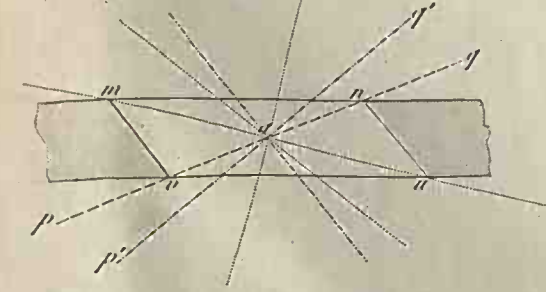


Fig. 14



Fig. 1.

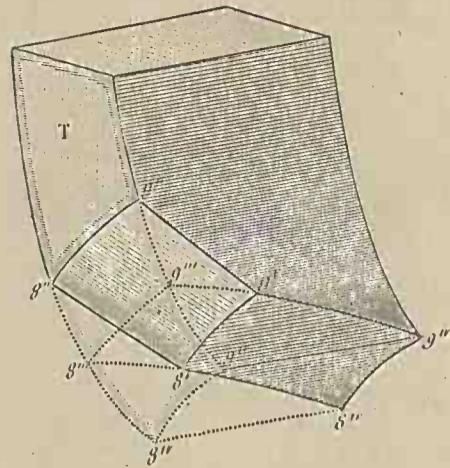


Fig. 2.

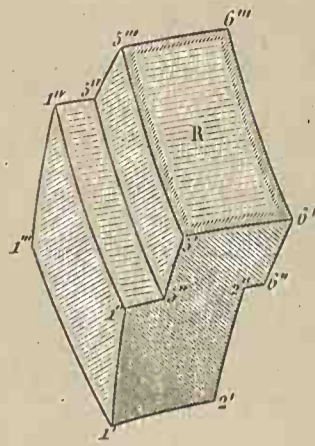


Fig. 3.

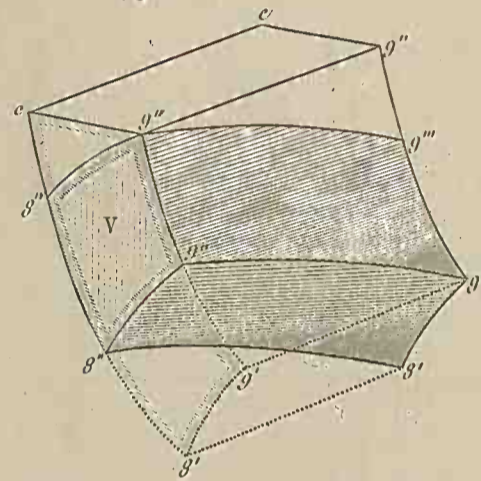


Fig. 4.

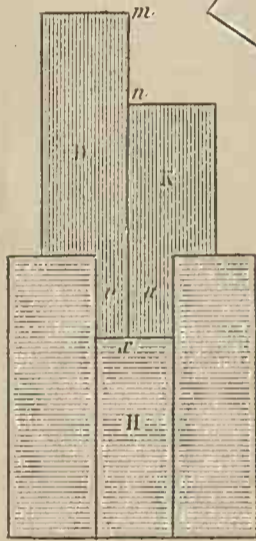


Fig. 5.

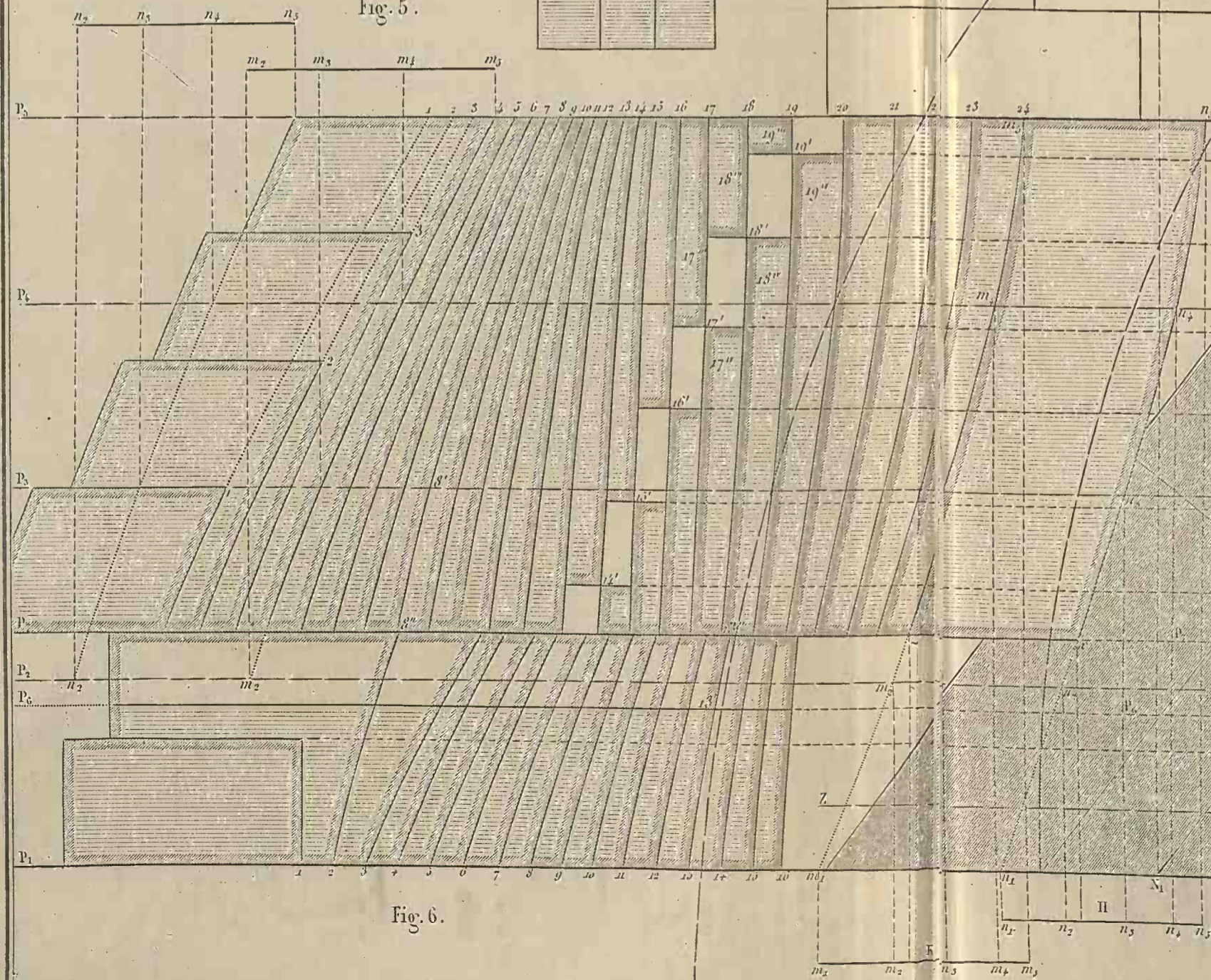


Fig. 6.

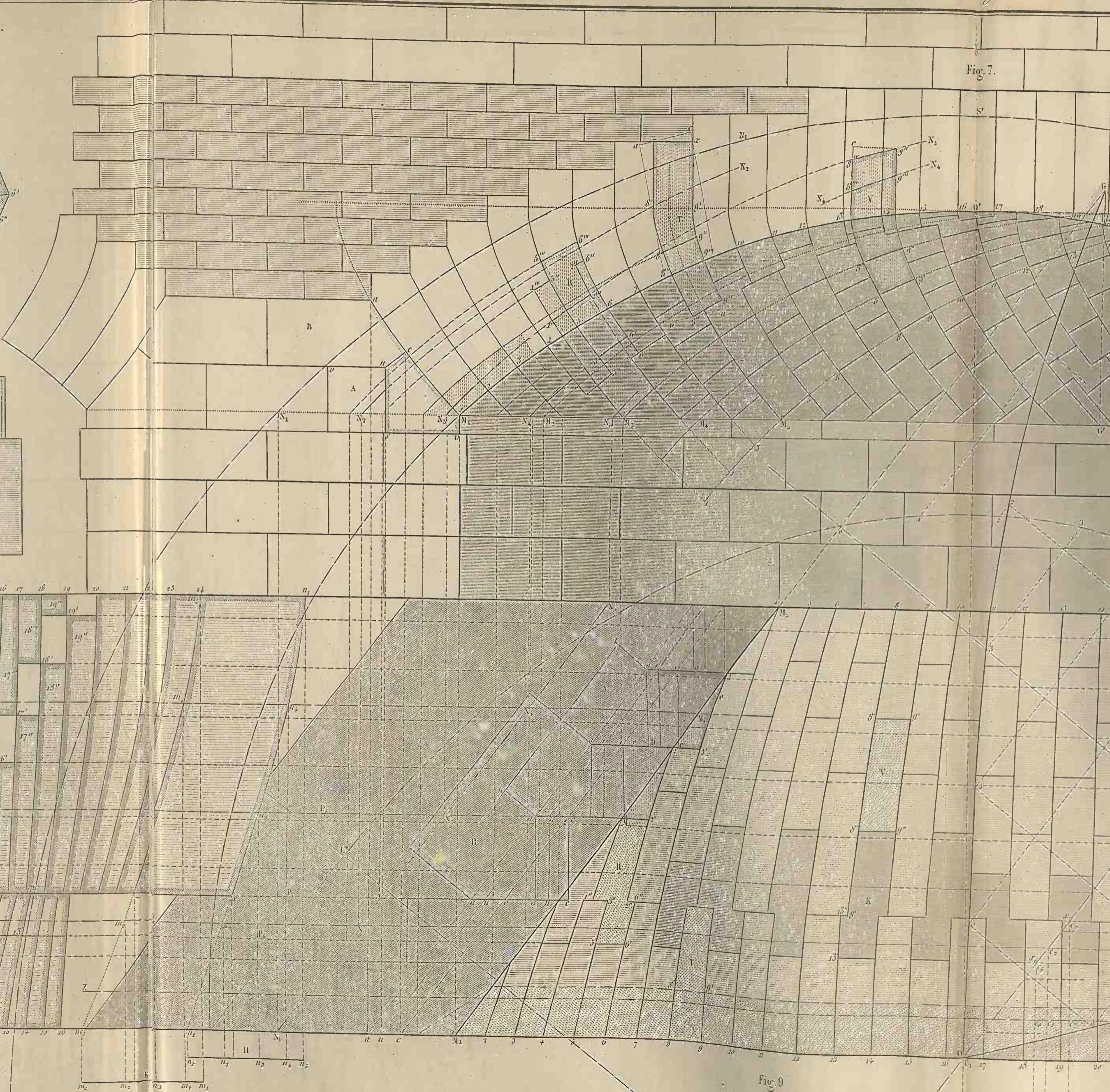


Fig. 7.

Fig. 9.

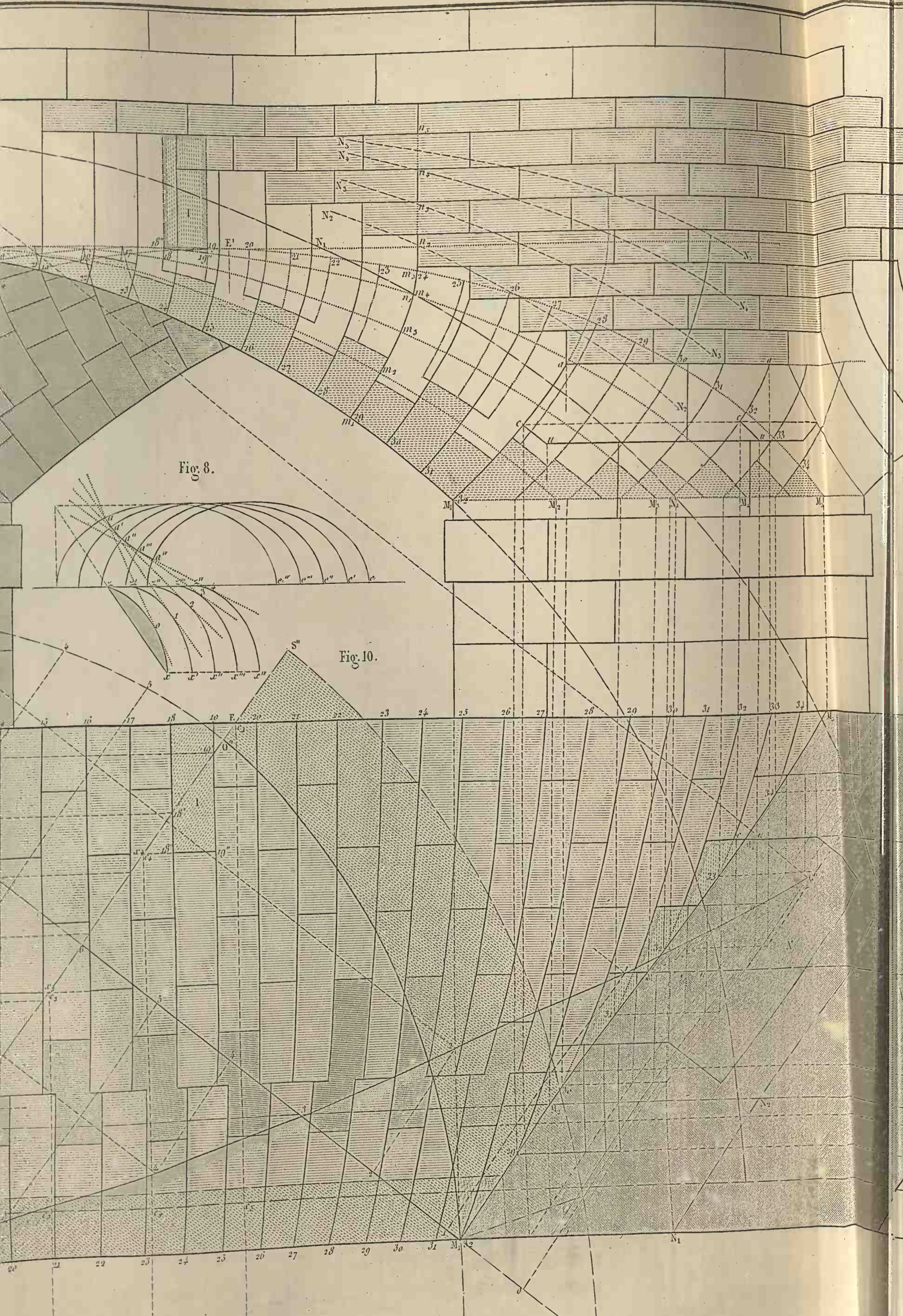


Fig. 8.

Fig. 10.

Fig. 11.

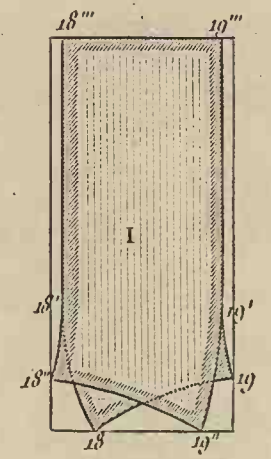


Fig. 12.

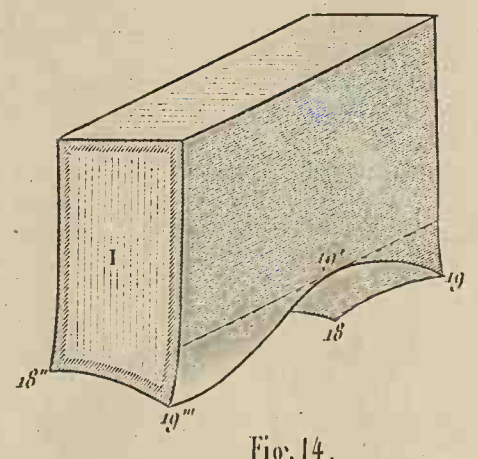


Fig. 13.

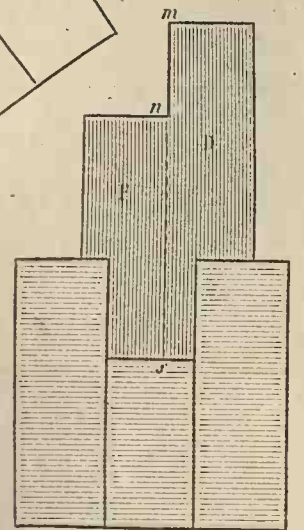


Fig. 14.

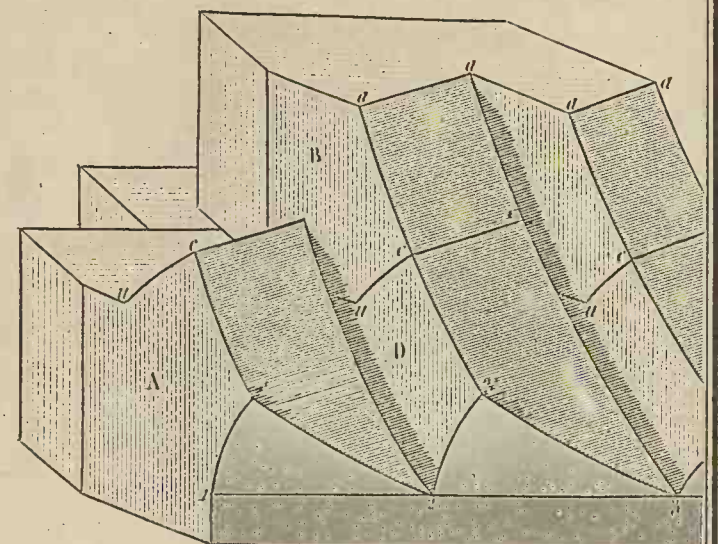


Fig. 15.

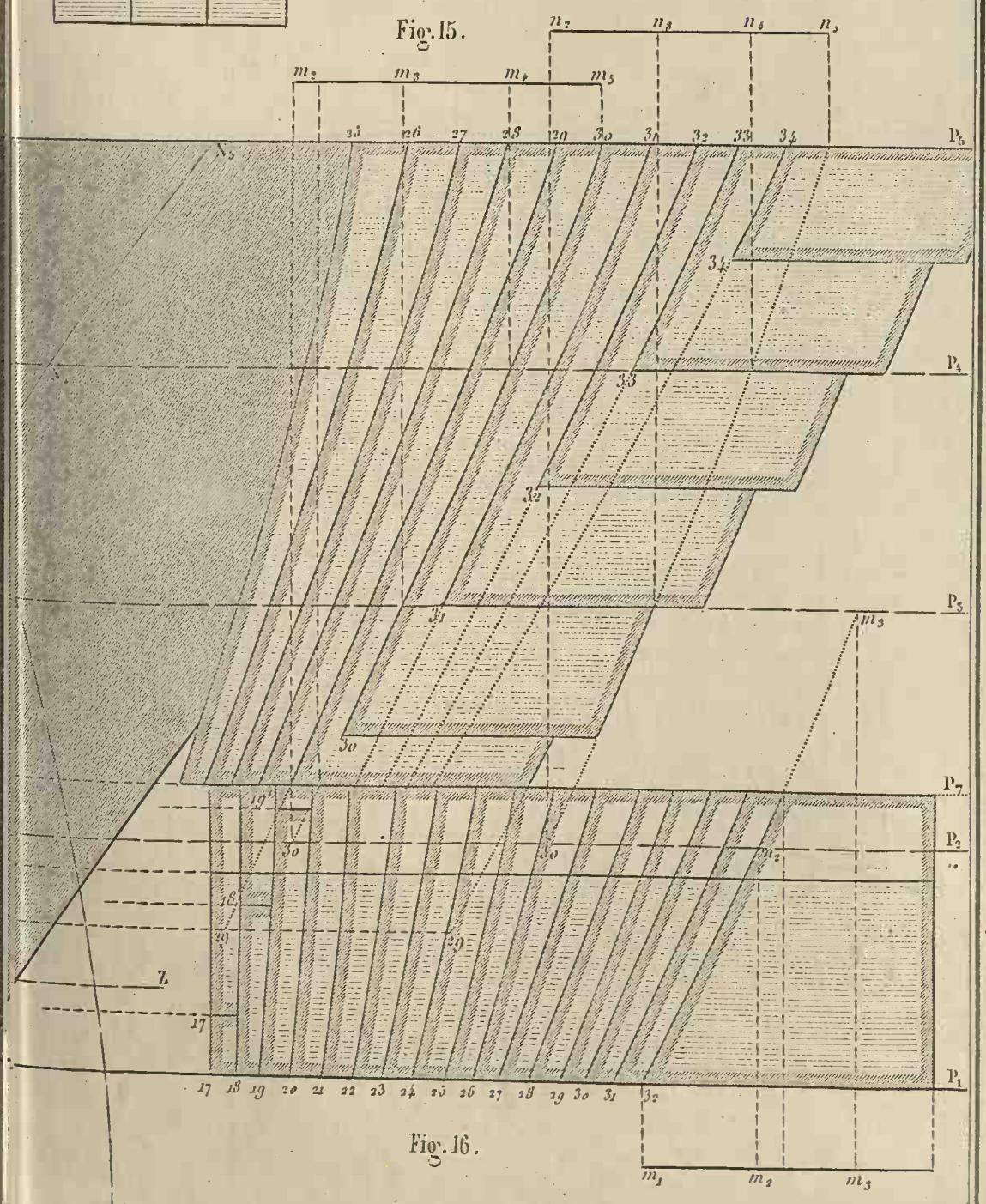


Fig. 16.